

**Benchmark®, Single Wall Oven, 30",
Stainless steel
HBLP454UC**



Included accessories

1 x oven racks /upper
1 x Broiler pan /upper
1 x temperature probe /upper

Optional accessories

HEZTR301 : Telescopic Oven Rack 30"

The Bosch All-in-One Wall Oven with Air Fry and left SideOpening door combines all your favorite kitchen tools into one appliance for the ultimate cooking versatility without the countertop clutter.

- Air fry mode quickly cooks foods to crisp perfection without adding oil.
- Dampened Hinges Softly and Quietly Guide the QuietClose™ Door Shut.
- Genuine European Convection provides even baking results on all racks, no matter where you place your pan.
- A Full-Extension Telescopic Rack Offers Safe Access to the Oven Cavity.
- **Pyrolytic self-cleaning:** Automatically cleans the oven, just wipe out the ash.

Technical Data

Cooking mode : 3rd element convection, Combination fusion cooking, Convection Bake, Convection Broil, Conventional heat, Dough proving setting, Eco, Half width variable grill, Pizza setting, Special baking setting, warming

Integrated Cleaning system : Self Clean

Interior Lights - cavity 1 : 2

Timer settings : Alarm, Off, On, timer

Included accessories : 1 x oven racks /upper, 1 x Broiler pan /upper, 1 x temperature probe /upper

Bake Element Wattages cavity 1 : 2400 W

Broil Element Wattages cavity 1 : 3800 W

Convection Element Wattages cavity 1 : 2000 W

Benchmark®, Single Wall Oven, 30", Stainless steel HBLP454UC

The Bosch All-in-One Wall Oven with Air Fry and left SideOpening door combines all your favorite kitchen tools into one appliance for the ultimate cooking versatility without the countertop clutter.

Design

- Color TFT Touch Control with SteelTouch™ buttons for easier operation
- Installs flush for a sleek, modern look

Performance

- Fast Preheat mode saves time so meals are ready sooner
- A 12 pass broil element sears, browns, and chars meats and casseroles to perfection
- Keep food warm without overcooking until ready to serve by using the warm mode

Efficiency

- 2, 3, and 4 hour self-clean cycles available, saving time and energy

Convenience

- Dampened hinges softly guide the QuietClose door shut so the oven door never slams
- Large, transparent oven window lets you easily monitor the cooking progress without opening the door
- 2 bright interior oven lights let you easily check on your meal's progress

Capacity

- 4.6 cu. ft. generous interior capacity fits a large turkey and multiple side dishes with ease

Benchmark®, Single Wall Oven, 30", Stainless steel HBLP454UC

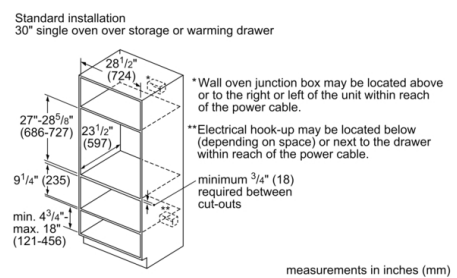
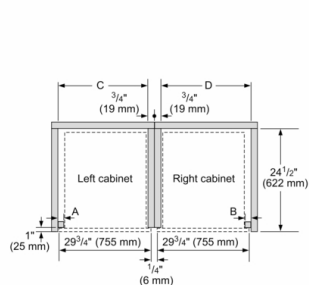
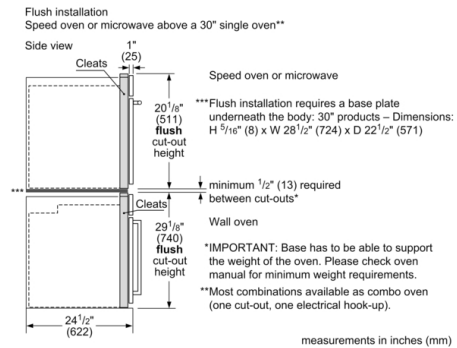
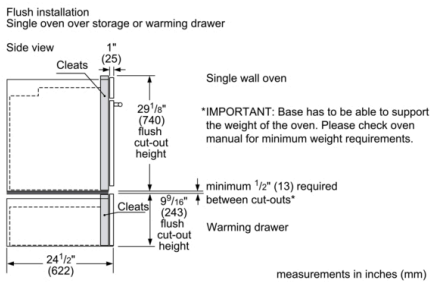
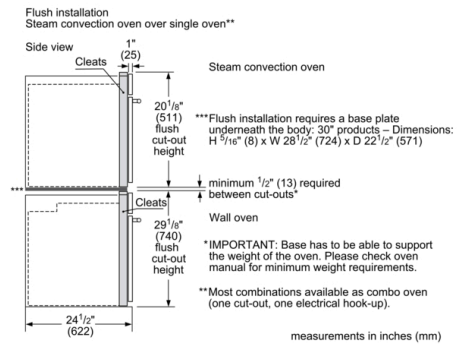

Combination Type	A Left reveal cleat	B Right reveal cleat	C cut-out width	D cut-out width
Flush bottom hinge	3/4" (19 mm)	3/4" (19 mm)	29 1/2" (743 mm)	29 1/4" (743 mm)
Flush side hinge (left)	1 1/2" (38 mm)	N/A*	30" (762 mm)	N/A*
Flush side hinge (right)	N/A*	1 1/2" (38 mm)	N/A*	30" (762 mm)

* Installation not recommended

measurements in inches (mm)

Benchmark®, Single Wall Oven, 30", Stainless steel HBLP454UC

Flush installation Top view

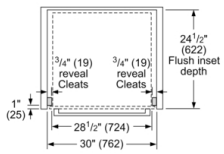

Side view

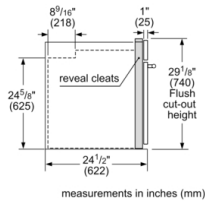

measurements in inches (mm)

Standard installation
30" speed oven or microwave above a single oven***

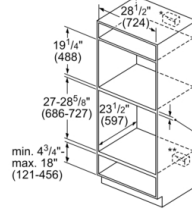

* Junction box may be located above or next to the unit within the reach of the power cable.

** Junction box may be located below (depending on space) or next to the unit within the reach of the power cable.

*** Most combinations available as combo oven (one cut-out, one electrical hook-up).

Minimum dimension between cut-outs:
 • 1" (25 mm) for wall oven cut-out height of 28 5/8"
 • 2 5/8" (67 mm) for wall oven cut-out height of 27"

measurements in inches (mm)

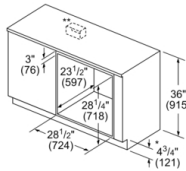

* Includes 3/4" (19) base plate

** For single ovens installed under a worktop, the junction box may be located to the left or right of the unit within reach of the power cable.

measurements in inches (mm)

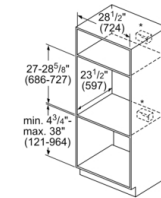

* For single ovens installed in a wall cabinet, the junction box may be located above or beneath the unit within reach of the power cable.

measurements in inches (mm)

measurements in inches (mm)

Standard side-by-side installation

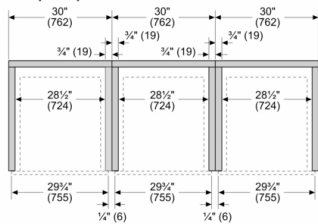

Configuration	A	B	C
Side-by-side-by-side 1	D	E	D
Side-by-side-by-side 2	E	F	E

- A: Left oven type
- B: Middle oven type
- C: Right oven type
- D: Conventional oven
- E: Steam, speed or microwave
- F: Conventional oven, Bottom hinge door modules only. Side hinge door not recommended.

measurements in inches (mm)

Flush side-by-side-by-side installation

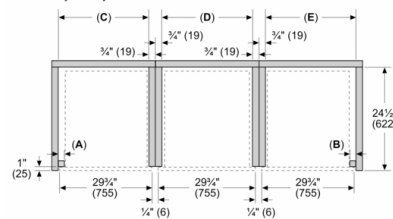

Combination type	A	B	C	D	E
Flush bottom hinge door	3/4" (19)	3/4" (19)	29 1/4" (743)	29 1/4" (743)	28 1/2" (724)
Flush left hinge door	1 1/2" (38)	F	30" (762)	F	F
Flush right hinge door	F	1 1/2" (38)	F	30" (762)	F

- A: Left reveal cleat
- B: Right reveal cleat
- C: Cut-out width
- D: Cut-out width
- E: Cut-out width
- F: Installation not recommended