

Café™ Professional Series 30" Built-In Convection French-Door Single Wall Oven

CTS90FP4NW2 / CTS90FP3ND1 / CTS90FP2NS1

CAFÉ

DISTINCT BY DESIGN™



ALSO AVAILABLE IN



CTS90FP3ND1
Matte Black with Brushed Stainless handles



CTS90FP2NS1
Stainless Steel with Brushed Stainless handles



FEATURES & BENEFITS

Professional design brought to life - Bring unparalleled sophistication to your kitchen with a French-door wall oven that exudes professional style and allows you to personalize the look with customizable handles and finishes

French door design for more approachable access - Bake with ease thanks to the purposeful French-door design, which allows you to open both doors using a single hand, and easily place food inside

Precision is the name of your cooking game - Confidently try new recipes and perfectly execute your favorites, using a smart system that automatically tracks progress, modifies temperatures and adjusts cook times

Brighten up life in the kitchen - Easily navigate wall oven settings using a stunning full color display that adds an unexpected touch of style to your kitchen

The perfect bake is now perfectly easy - Achieve unrivaled performance with the only system that delivers top-down true convection for consistent results on special occasion favorites like roasts, chicken, turkey and more

No preheat, no hassle - Save time with a variety of precision cooking modes that eliminate the need for preheating

Fried taste. Crisp texture. Less oil. - Make your favorite "fried" foods healthy, thanks to a mode that crisps without using oil for frying

Create a look that matches your personal style - Select any combination of premium finishes and hardware options to create a stunning look customized to any owner's taste

Enjoy convenient temperature control from anywhere - Preheat while running errands or change oven temperatures while doing yard work with the Café Appliances Kitchen app

The oven rack that handles it all - Easily remove heavy dishes with a roller rack that is specially designed to glide smoothly and stay in the oven during the self-clean cycle, so you never have to handle cumbersome racks again

The perfect fit you've always dreamed of - When you're updating your kitchen, attention to detail is a priority. That's why Café wall ovens are guaranteed for an exact fit or Café Appliances will pay up to \$300 toward modifications.

APPEARANCE

Handle	Café Pro Style; Customizable
Installation	Above Warming Drawer; Side-by-Side; Under Built-In Advantium; Under Built-In Microwave

FEATURES

Configuration	French Door
Cooking System	True European Convection with Direct Air
Oven Cleaning Type	Self-Clean with Steam Clean Option
Cleaning Time	Variable with Delay Clean Option
Oven Cooking Modes	Convection Bake; Convection Bake Multi-Rack; Convection Broil Hi/Lo; Convection Roast; Hot-Air Frying; Precision Cooking Modes; Proof; Thermal Bake; Thermal Broil Hi/Lo; Warm Mode
Self-Clean Oven Door Lock	Automatic
Control Type	7" Full-Color Touch LCD Screen
Oven Features	10-Pass Bake Element; 10-Pass Dual Broil Element; Closed Door Broiling
Oven Rack Features	2 Never-Scrub Roller Racks; 6 Embossed Rack Positions
Product Type	Wall Oven Single
Oven Control Features	12-Hour Shut-Off Capability; Audible Preheat Signal; Auto Recipe Conversion; Certified Sabbath Mode; Control Lock Capability; Cook Time; C° or F° Programmable; Delay Time; Electronic Clock & Kitchen Timer; Mis-Wire Detection; Remote Enabled; Scan-to-cook; Temperature Probe
WiFi Connect	Built-In
Connected Capabilities	Amazon Alexa; Drop; IFTTT; Innit; Nest; The Google Assistant
Cooking Technology	Convection
Oven Interior	2 Halogen Interior Oven Lights; Black Gloss Finish; Hidden Bake

CAPACITY

Total Capacity (cubic feet)	5.0
-----------------------------	-----

POWER / RATINGS

Amp Rating at 208V	20
Amp Rating at 240V	20
Bake Wattage	2850W
Broiler Wattage	4300W
Convection Wattage	2400W
KW Rating at 208V	3.4
KW Rating at 240V	4.5

WEIGHTS & DIMENSIONS

Approximate Shipping Weight	208
Net Weight	190
Overall Height	28-5/8
Overall Width	29-3/4
Overall Depth	26-3/4
Cabinet Width	30
Cutout Dimensions (w x h x d) (in.)	28-5/8 x 27-5/16 x 23-1/2
Oven Interior Dimensions (W x H x D) (in.)	25 x 17-3/8 x 20-1/4

OPTIONAL ACCESSORIES

30" Never-Scrub Roller Rack	UXWORXR30
Large Broiler Pan	WB48X10056
72" Replacement Electrical Conduit	WB18T10580

Café™ Professional Series 30" Built-In Convection French-Door Single Wall Oven

CTS90FP4NW2 / CTS90FP3ND1 / CTS90FP2NS1

CAFÉ

DISTINCT BY DESIGN™

WARRANTY

Parts warranty	Limited 1-year entire appliance
Labor warranty	Limited 1-year entire appliance
Warranty notes	See written warranty for full details

DIMENSIONS AND INSTALLATION (IN INCHES)

Most 30" Wall Cabinets can be used with this unit.

Note: These ovens are not approved for stackable installations. Cabinets installed adjacent to wall ovens must have an adhesion spec of at least a 194°F temperature rating.

Door handle protrudes 2-1/2" from door face. Cabinets and drawers on adjacent 45° and 90° walls should be placed to avoid interference with the handle.

Electric wall ovens are not approved for installation with a plug and receptacle. They must be hard wired in accordance with installation instructions.

Installation Information: Before installing, consult installation instructions packed with product for current dimensional data and for alternate installation options.

Note: This model is not approved for installation below a countertop or in combination with a separate cooktop. The minimum installation height from the floor is 16-1/4".

A minimum gap of 14" from either side of the wall oven to an adjacent 45 or 90 cabinet, drawer or was is required to avoid interference with the opening of the doors. The handles protrude 2-1/2" from the door face.

Countertops may need to be notched on either side of the wall oven to avoid interference with the opening of the doors.

THIS MODEL IS NOT APPROVED FOR FLUSH-MOUNT INSTALLATION

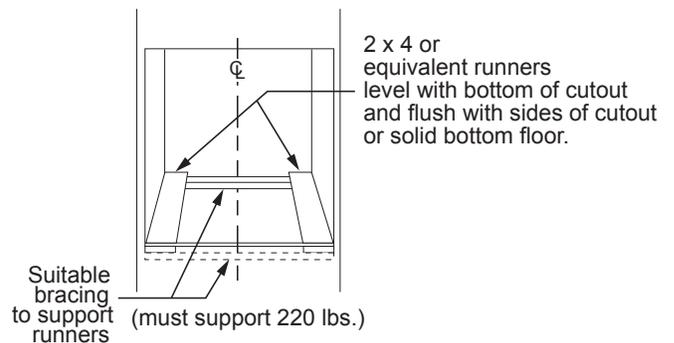
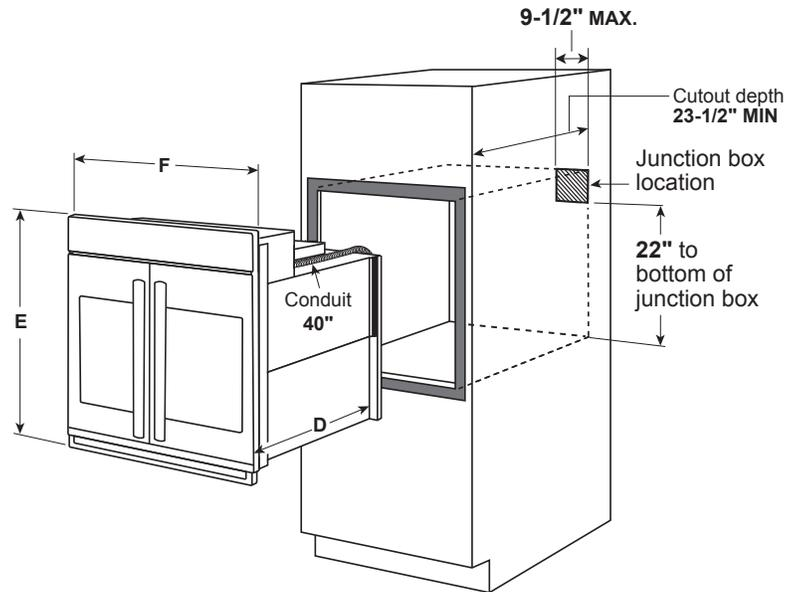
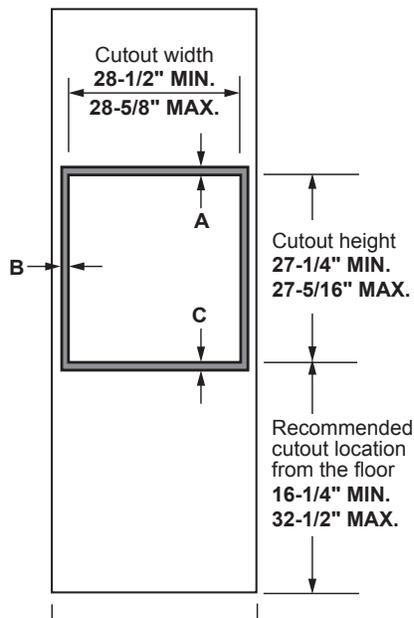

Cabinet	30"
A - Overlap of oven at top of cutout	1-1/4"
B - Overlap of oven other side of edge of cutout	3/4"
C - Overlap of oven at bottom of cutout	1-1/4"
Oven	
D - Install depth	23-1/2"
E - Overall height with trim	28-5/8"
F - Overall width	29-3/4"

DIMENSIONS AND INSTALLATION INSTRUCTIONS ARE SHOWN IN INCHES

Café™ Professional Series 30" Built-In Convection French-Door Single Wall Oven

C A F É

DISTINCT BY DESIGN™

CTS90FP4NW2 / CTS90FP3ND1 / CTS90FP2NS1

DIMENSIONS AND INSTALLATION (IN INCHES)

Note: This model is not approved for installation below a countertop or in combination with a separate cooktop. The minimum installation height from the floor is 16-1/4".

Note: A minimum gap of 14" from either side of the wall oven to an adjacent 45 or 90 cabinet, drawer or was is required to avoid interference with the opening of the doors. The handles protrude 2-1/2" from the door face.

Note: Countertops may need to be notched on either side of the wall oven to avoid interference with the opening of the doors.

Installation information: Before installing, consult installation instructions packed with products for current dimensional data and for alternate installation options.

THIS MODEL IS NOT APPROVED FOR FLUSH-MOUNT INSTALLATION

SIDE BY SIDE INSTALLATION FRONT VIEW OF CUTOUTS

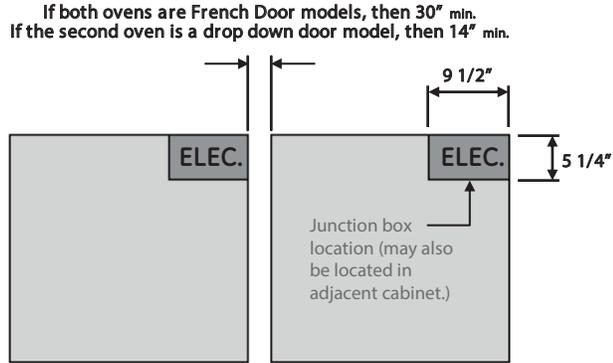

INSTALLATION TO ADJACENT COUNTERTOP AND CABINET DOORS

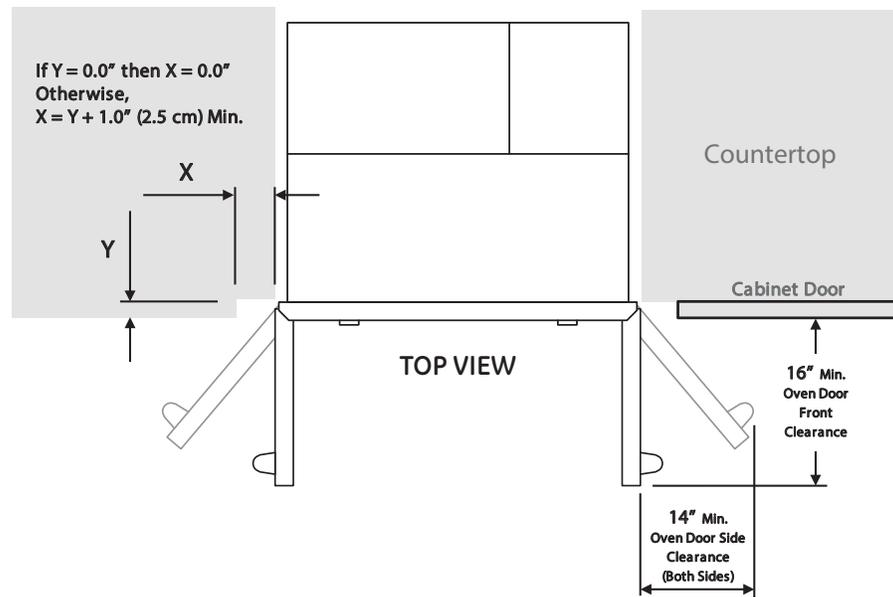

DIMENSIONS AND INSTALLATION INSTRUCTIONS ARE SHOWN IN INCHES

ADDITIONAL ACCESSORIES



CXWSFHKMNBZ
Brushed Bronze
2 handles
(standard on Matte White)



CXWSFHKMNSS
Brushed Stainless
2 handles
(standard on Matte Black)



CXWSFHKMNB
Brushed Black
2 handles



CXWSFHKMNCU
Brushed Copper
2 handles