



CVU306C-SS

30 Inch 600 CFM Undercabinet Range Hood



The Caloric Undercabinet Range Hood is the ideal addition to any kitchen. With a powerful 600 CFM motor suction, it can quickly and efficiently remove smoke, steam and odors from your kitchen.

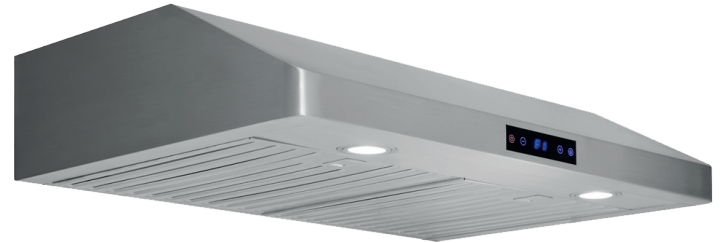

Featuring three different speeds that provide flexibility in suction, LED lighting for better illumination, and a touch control panel, you can easily customize the hood to meet your needs.

The stainless-steel baffle filters are washable, and can be vented to the top or rear of the unit with either a 6" round exhaust or 3 1/4 x 10" rectangular exhaust, providing you with flexibility in installation. With a maximum of 5 sones, the noise levels you experience easily fit your space and your surroundings.

The Undercabinet Hood is a stylish and reliable addition to your kitchen and comes with a 1-year parts and labour warranty.

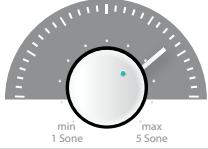

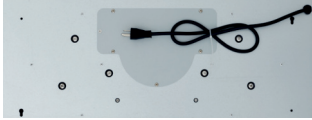
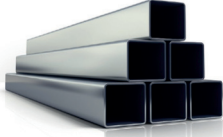
Features	Benefits	
600 CFM, 3 speed motor	Creates powerful, flexible and efficient ventilation to quickly remove smoke and odors from the kitchen	
LED Lighting	Powerful, bright, illuminating light for better visibility in the kitchen	
Adjustable sound levels: 1 Sone (Min) - 5 Sones (Max)	Low noise levels while providing powerful ventilation.	
Stainless Steel Baffle Filters	Easy-to-maintain, durable and washable.	
Electronic Touch Controls	Easy to use and intuitive controls to quickly adjust the hood's settings	

Features	Benefits	
110V/60Hz	Compatible with the standard electricity supply	
Top or Rear Venting - 6" Round Exhaust or 3 1/4 x 10" Rectangular Exhaust	Flexible installation and exhaust options to suit the needs of any kitchen	
Premium Stainless Steel - Type 201	Stronger and thicker stainless steel is more corrosion resistant and non-magnetic.	
1 Year Parts and Labour Warranty	Peace of mind and provides confidence that your Undercabinet Hood will work reliably and effectively for years to come.	
Optional Plasma Filtration Kit	Ability to recirculate and clean the air in your kitchen without costly filter replacements	

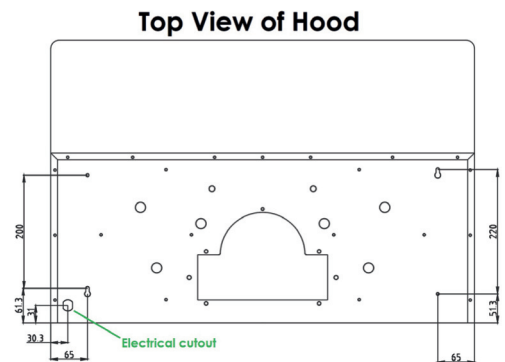
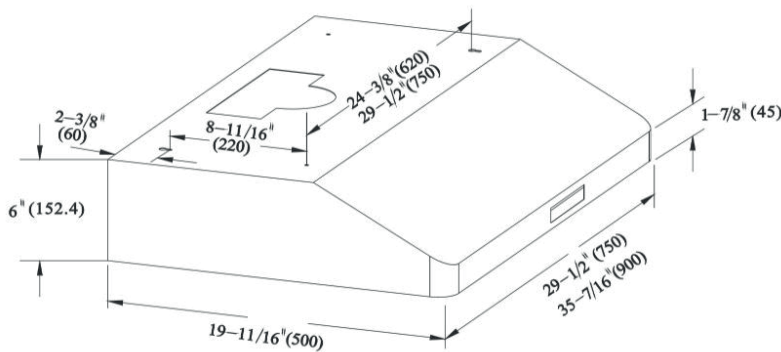

Weights & Dimensions Specification

Width	30"
Depth	19 11/16"
Height	6"
Weight	36.6 lbs
Carton	33" x 10" x 23"



UPC code
628451852209

844-455-3474 | info@caloricappliances.ca

2023 In Canada, Caloric™ is a registered trademark of J.A.K. North America Inc.
Specifications are for planning purposes only and are subject to change, Refer to installation instructions.