

Chambers®

Installation and Operating Instructions

MODEL:MRB192-07

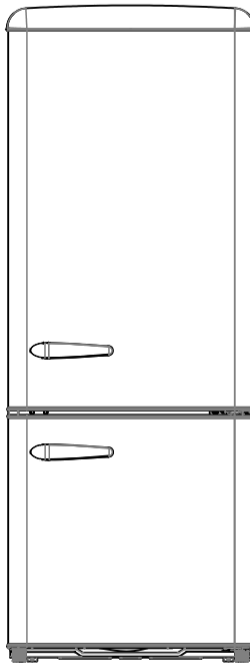

Please read these instructions carefully before attempting to install or use this the refrigerator. Keep these instructions in a safe place for future reference.

Table of Contents

1. Important Safety Instructions
3. Refrigerator Terminology
3. Controlling the Temperature
4. The Refrigerator Compartment
4. The Freezer Compartment
5. Defrost
5. Power Outages
6. Installing the Refrigerator
7. Care and Maintenance
6. Storing Food
7. Care and Maintenance
8. Troubleshooting

1. IMPORTANT SAFETY INSTRUCTIONS

These warnings are provided in the interest of your safety. Ensure that you understand all of them before installing or using this the refrigerator. Your safety is of paramount importance. If you are unsure about any of the meanings or these warnings contact Chambers® @ 1-844-455-3474.

Installation

Please take care when moving this the refrigerator as it is very heavy. Do not alter or modify the refrigerator in any way. Ensure that the refrigerator does not stand on the electrical supply cable. If the power cord is damaged, it must be replaced by a certified the refrigerator technician. If any electrical work is required to install this the refrigerator, it should be carried out by a qualified electrician or competent person. Parts that heat up should not be exposed. Whenever possible, the back of the refrigerator should be close to a wall but leave the required distance for ventilation as stated in the installation instructions. The refrigerator should be left for 24 hours after installation before it is turned on, to allow the refrigerant to settle. Failure to follow these instructions could result in severe injury and/or damage to the refrigerator.

WARNING - The refrigerator must be positioned so that the plug is accessible.

WARNING - Keep ventilation pathways of the refrigerator (and the cabinet enclosure if applicable) clear of obstruction.

WARNING - Do not use mechanical devices, thermal devices, or other means to accelerate the defrosting process, other than those recommended by the manufacturer.

WARNING - Do not damage the refrigerant system. The refrigerant and vesicant are flammable and explosive which could result in severe injury if exposed.

WARNING - If the supply cord is damaged, it must be replaced by the manufacturer or its service agent or a similarly qualified person in order to avoid a hazard.

WARNING - Useless and old the refrigerators should be recycled and disposed by professional companies.

WARNING - Do not use electrical the refrigerators inside the food storage compartments of the refrigerator, unless they are recommended by Chambers®.

Caution

To reduce the risk of fire, electrical shock, or injury:

1. Do not use outdoors or on wet surfaces.
2. Use only as described in this manual. Use only Chambers® recommended attachments.
3. Do not use with damaged cord or plug.
4. If the refrigerator has been dropped, damaged, left outdoors, or dropped in water, have it inspected and repaired at an authorized service center before use.
5. Do not pull or carry by cord, use cord as a handle, close a door on cord, or pull cord around sharp edges or corners.
6. Keep cord away from hot surfaces.
7. Do not unplug by pulling on cord. Grasp the plug, not the cord, when disconnecting from power.
8. Do not handle plug or the refrigerator with wet hands.
9. Do not use to store flammable or combustible liquids such as gasoline or use in areas where they may be present.
10. Using improper voltage may result in damage to the refrigerator and possible injury to the user. Correct voltage is listed on the rating label.
11. Do not use for any purpose other than described in this user's guide.
12. The refrigerator is not intended for use by persons (including children) with reduced physical, sensory of mental capabilities, or lack of experience and knowledge, unless they are under supervision of a person responsible for their safety.
13. Children should be supervised to ensure that they do not play with the refrigerator.

Refrigerant

The refrigerant isobutane is contained within the refrigerant system of the refrigerator. It is a natural gas with a high level of environmental compatibility, but nevertheless is flammable. During transportation and installation of the refrigerator, be certain that none of the components of the refrigerant system become damaged. If the refrigerant system should become damaged: avoid open flames and sources of ignition, thoroughly ventilate the room in which the refrigerator is situated, and call a service technician immediately.

Child Safety

Do not allow children to tamper with the controls or play with the product.

Packaging (e.g. wraps, polystyrene) can be dangerous for children.

There is a risk of suffocation! Keep packaging material away from children!

Please make sure your old refrigerator is unusable prior to disposal. Pull out the mains plug, cut off the mains cable, break or remove the spring or bolt locks, if fitted. By doing this you ensure that children cannot lock themselves in the refrigerator when playing or get themselves into other dangerous situations.

Often children cannot recognize the hazards present in household refrigerators. It is therefore important that you ensure adequate supervision and never let children play with the refrigerator!

During Use

This refrigerator is designed for indoor use only, specifically for the storage of edible foodstuffs only. Frozen food should not be refrozen once it has thawed out. Do not place carbonated or fizzy drinks in the freezer. Popsicles, or other water based foods, can cause "frost/freezer burns" if consumed straight from the freezer. Do not remove items from the freezer if your hands are damp/wet, as this could cause skin abrasions or frost/freezer burns. Chambers® recommended storage times should be adhered to. Refer to relevant instructions.

Maintenance and Cleaning

Switch off and unplug the refrigerator before carrying out any cleaning or maintenance work. Do not use sharp instruments to scrape off frost or ice. (See defrosting instructions).

Servicing

This product should be serviced by an authorized engineer, and only genuine spare parts should be used. Under no circumstances you should attempt to repair this machine yourself. Repairs carried out by inexperienced persons may cause injury or serious malfunctioning. Contact Chambers® @ 1-844-455-3474 for information on authorized service centers.

Disposal

When disposing of your refrigerator, use an authorized disposal site. Remove the plug and ensure that any locks or catches are removed, to prevent young children being trapped inside.

2. Refrigerator Terminology

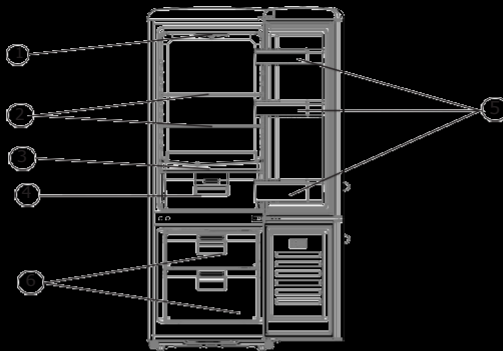

- ① Temperature regulator
- ② Storage shelves
- ③ Crisper cover
- ④ Crisper
- ⑤ Door shelves
- ⑥ Drawer

3. Temperature Control

◦ Temperature regulator

The temperature regulator dial is located on the RH side of the refrigerator compartment.

Position "0" is OFF

Turning clockwise in direction will turn **ON** the refrigeration system

Position "1" means: Highest temperature, warmest setting.

Position "7" means: Lowest temperature, coldest setting.

At a low surrounding ambient temperature of around 16°C, setting "1" should be selected. At surrounding ambient temperatures of around 25°C, select setting "2". If you require a lower temperature, select setting "3" or "4".

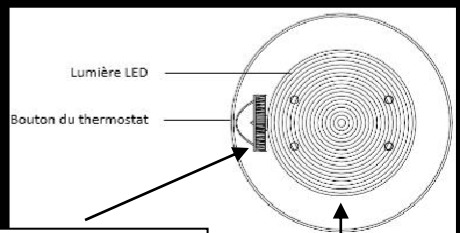

Temperature Regulator Dial

LED Light

Changing the Light Bulb

Warning: Disconnect the power supply before replacing the bulb.

1. Turn off the power supply;
2. Remove the screw that secures the interior light Perspex cover in place and remove the cover.
3. Unscrew the bulb and replace with the same specification bulb.
4. Replace the cover.

4. The Refrigerator Compartment

The refrigerator compartment is for storing food that does not need not be frozen. Different Zones in the chamber have different temperatures to suit different kinds of foods. Cooler temperatures are in the lower part of the fridge and warmer ones are at the top.

Refrigerator Shelves

The shelves can be cleaned and adjusted, and food or containers can be placed on them.

Vegetable drawer

This is for fruit and vegetable storage.

Door racks

Door racks are suitable for storing eggs, bottles, canned foods etc.

5. The Freezer Compartment

The freezer compartment is for freezing and storing frozen foods, or making ice cream etc.

Note: Do not store freezable liquids in breakable containers, because the volume will expand when frozen, destroying the container.

6. Defrost

1. If frost builds up in the freezer compartment it will influence the cooling performance of the fridge. If the thickness of the frost is greater than 5mm it is time to defrost the fridge. To do this you must unplug the fridge and remove all the perishable food from the unit. Leave the door open until all the frost has melted. Wipe up any water with a soft clean cloth.
2. The defrost water will flow to the base of the compressor to evaporate through the drainage pipe behind the wall of the refrigerator compartment. The drainage pipe must be installed firmly to avoid the water dripping onto the compressor electrical box and dripping onto the floor.

Notice: Do not use sharp tools to scrape the frost. Do not use hot water or a hair dryer to heat the cabinet wall directly to accelerate defrost.

7. Power Outages

1. If you receive a power outage notice, lower the temperature 2-3 hours before the outage and make as many ice cubes as much as possible to place in the refrigerator compartment.
2. Do not open the door if possible.
3. If the power is off for an extended period, check the freezer compartment for any melted water. If there is water in bottom of the compartment, wipe it up with a soft clean cloth.

8. Installation

Ventilation

To easily dissipate heat and to increase the efficiency of refrigeration and power consumption, a space should be left around the refrigerator. Please keep 100 mm of space at the back of the refrigerator, 200mm on both sides of the refrigerator and 300mm above the refrigerator. Enough space should be left so that the door can open 160 degrees.

Power supply

The refrigerator will only operate with 110V power. Use an individual socket and do not share with other electric refrigerators for best performance.

Power supply cord

Do not extend or fold the power cord. Keep the power cord away from the compressor because the temperature of the compressor surface rises during operation. If the cord comes into contact with excessive heat, the power cord insulation can be weakened, and current leakage can occur.

Protection from moisture

Do not locate the refrigerator in a moist environment to avoid corrosion of metal parts.

Adjustable feet

The feet can be adjusted to level the fridge. When your refrigerator is moved to a new location, twist the feet to adjust the refrigerator height. Use a level to make sure the height is even on all sides.

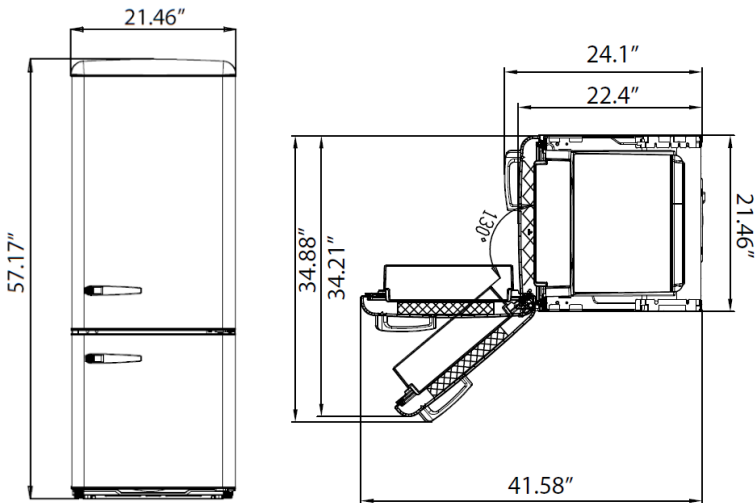

9. Care and Maintenance

Cleaning methods

1. Clean the refrigerator with a soft cloth, use warm water or neutral detergent.
2. Then dry it with another cloth.
3. In case of especially dirty spots such as glue, oil, you may wipe them with alcohol.
4. It is advisable to clean the refrigerator once a month.

Maintenance of plastic parts

If the plastic parts in the refrigerator are contaminated by oil (animal oil or vegetable oil) for a long time, they will become aged, cracked, and smell bad. Therefore, you should get the habit of cleaning it regularly.

Electric parts

Please use a dry cloth to clean the electrical parts to avoid electric shock.

Notes

1. When cleaning, unplug the refrigerator.
2. Do not spray water directly on the refrigerator as it will weaken the electrical insulation and cause the metal to rust.
3. It is recommended to use a neutral detergent. The following materials may damage the lacquer coat and plastic surface:
basic detergent, abrasive powder, hot water, banana oil, gasoline and alcohol.

10. Trouble shooting

The fridge will not turn on

- The refrigerator is under the direct sunshine or near heating source.
- The plug is not inserted correctly. The fuse has tripped.
- The thermostat knob is at '0' position.

Not Cooling Well

- There is too much food in the refrigerator, or the airflow is blocked.
- The refrigerator doors are not closed properly. Air leakage occurs due to the door gasket being broken or bent.
- Bad ventilation is around the refrigerator. Hot food has been placed in the refrigerator.
- There are no spaces around the refrigerator.
- The refrigerator is placed under the direct sunshine or near heating source.

Sounds like water running

- It is not sound of water running, but the sound of refrigerant flowing, it is not a fault.

Warm on both sides and the front frame of the refrigerator

- It is not a malfunction, as there are condensers on both sides and the front frame of the refrigerator, they get warm when the refrigerator is in operation.

Dew on both sides of the refrigerator

- In humid weather dew appears on both sides of the refrigerator. This is not a malfunction; you can wipe it away with a dry cloth.

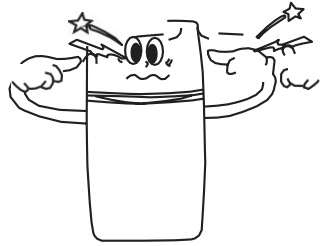

Runs loudly or makes strange noises

- The refrigerator is not level.
- The refrigerator is touching the wall.
- The exterior refrigeration tubes are touching each other, or the refrigeration tubes are touching the inner side of the cabinet.

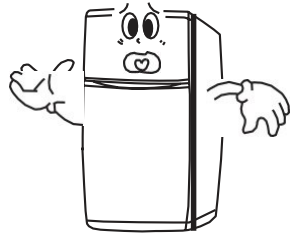

Compressor is constantly running

- The ambient temperature is very high and the temperature control in the freezer chamber or in the refrigerator chamber is set too high.
- Too much food is placed in the refrigerator and there are insufficient spaces for airflow.
- The door is not closed completely, or the gasket is not sealing well.
- Opening the door too frequently.

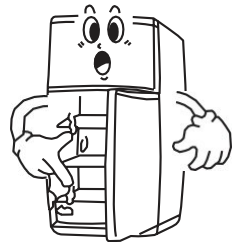

Dew inside the cabinet

- The ambient temperature is high, and the door is open for a long time.
- Liquid food is not covered before storage

Frozen foods in the refrigerator

- The temperature controller is set too high.
- The ambient temperature is below 5°C.



For Warranty Information:

Visit Our Website

www.chambers-appliances.com

Call Us:

1-844-455-3474

Send Us An Email:

chambers@jakag.com

Chambers[®] Appliances

www.chambers-appliances.com

chambers@jakag.com

Chambers[®] is used under license by J.A.K. North America Inc. in the U.S.
Chambers[®] is a registered trademark of J.A.K. North America in Canada.