



27" WARMING DRAWER PRO HANDLE

HWD27PS



AVAILABLE MODELS

HWD27PS 27" Warming Drawer Pro Handle, Silver Stainless

GENERAL PROPERTIES

FINISH	SILVER STAINLESS STEEL
--------	------------------------

TECHNICAL INFORMATION

ELECTRICAL REQUIREMENTS	120V/60HZ
-------------------------	-----------

TOTAL CONNECTED LOAD	120V/60HZ/15A
----------------------	---------------

TOTAL AMPS	4 AMPS
------------	--------

UTILITY LOCATIONS	RIGHT REAR ADJACENT CABINET OR BELOW INSTALLATION AREA
-------------------	--

PRODUCT DIMENSIONS

APPLIANCE DIMENSIONS (W X H X D) (IN.)	27" X 10 1/8" X 24 29/64"
--	---------------------------

CUT OUT DIMENSIONS (W X D) (IN.)	25 1/2" X 24" DEPTH MINIMUM
----------------------------------	-----------------------------

DRAWER CAPACITY	1.53 CU. FT.
-----------------	--------------



FEATURES & BENEFITS

- Electronic Control Panel.
- Four Temperature Levels—Proof, Low, Medium and High (100-200°). Temperature will automatically set to the last temperature setting used when the drawer is turned on.
- Four Timer Settings—1, 2, 3 & 4 hours plus an infinite time mode which keeps the warming drawer on until you turn it off.
- The Infinite mode is very useful when you need the warming drawer on for extended periods of time like during parties and events or for use during the Sabbath.
- Blue LED Indicator lights.
- Large Capacity.
- 50 pound weight limit.
- Quick to heat with 500 watt heating element.
- Approved for installation under Dacor wall ovens, microwaves, cooktops and in under counter applications.

UNITS DIMENSIONS

MODEL	A Drawer Face Width	B Chassis Face Width	C Chassis Width
HWD27PS	27" (68.6 CM)	26 5/8" (67.6 CM)	25 1/4" (64.1 CM)

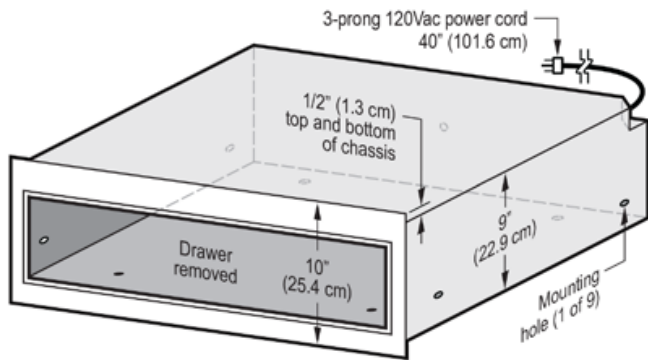
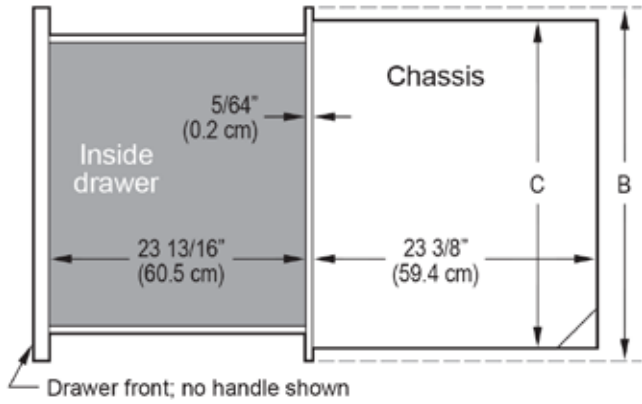

HANDLE DIMENSIONS

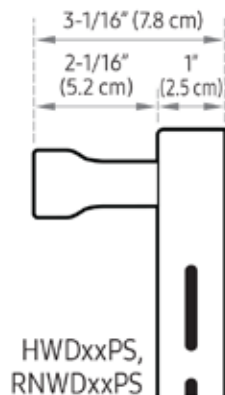

CUTOUT DIMENSIONS

MODEL	A	B	C	D	CUT OUT MIN.
HWD27PS	25 1/2"	27 1/4"	9 1/8"	1 1/4"	24"

CUTOUT DIMENSIONS

