



Use & Care Guide

Built-In High Speed Oven



 **Electrolux**

TINSEB425MRRO

2 Finding Information

MAKE A RECORD FOR FUTURE USE

Brand _____

Purchase Date _____

Model Number _____

Serial Number _____

NOTE

See the Features page later in this manual for the location of your product's serial number.

QUESTIONS?

For toll-free telephone support in the U.S. and Canada.

1-877-4ELECTROLUX (1-877-435-3287)

For online support and internet product information:

www.electrolux.com

PRECAUTIONS TO AVOID POSSIBLE EXPOSURE TO EXCESSIVE MICROWAVE ENERGY

- (a) Do not attempt to operate this oven with the door open since open-door operation can result in harmful exposure to microwave energy. It is important not to defeat or tamper with the safety interlocks.
- (b) Do not place any object between the oven front face and the door or allow soil or cleaner residue to accumulate on sealing surfaces.
- (c) Do not operate the oven if it is damaged. It is particularly important that the oven door close properly and that there is no damage to the: (1) door (bent), (2) hinges and latches (broken or loosened), (3) door seals and sealing surfaces.
- (d) The oven should not be adjusted or repaired by anyone except properly qualified service personnel.

TABLE OF CONTENTS

FINDING INFORMATION	2-3	AUTOMATIC COOKING	19-32
MAKE A RECORD FOR FUTURE USE	2	SPEED COOKING	19
QUESTIONS?	2	BASIC COOK CHART	20-23
TABLE OF CONTENTS	3	RECIPES	24-28
IMPORTANT SAFETY INSTRUCTIONS ..	4-5	MICROWAVE OPTIONS	29
UNPACKING & INSTALLATION INSTRUCTION	6	POPCORN	29
GROUNDING INSTRUCTIONS	7	POPCORN CHART	29
INFORMATION YOU NEED TO KNOW ...	8-12	REHEAT / COOK	29
ABOUT YOUR OVEN	8	REHEAT CHART	30
ABOUT MICROWAVE COOKING	8	COOK CHART	30-31
ABOUT CHILDREN	9	DEFROST	31
ABOUT FOOD	9	DEFROST CHART	32
ABOUT UTENSILS AND COVERINGS	10	MANUAL DEFROST	32
ABOUT SPEED COOKING AND CONVECTION		OTHER CONVENIENT FEATURES	33-35
COOKING	12	DEMONSTRATION MODE	33
ABOUT SAFETY	12	AUTOMATIC COOKING TIME ADJUSTMENT ...	33
PART NAMES	13-14	TIMER	33
OVEN PARTS	13	MULTIPLE SEQUENCE COOKING	33
INTERACTIVE DISPLAY	14	HELP	34
CONTROL PANEL	14	ADD A MINUTE	35
BEFORE OPERATING	15	HELP (INTERACTIVE DISPLAY)	35
TO SET THE CLOCK	15	CLEANING AND CARE	36
STOP/CLEAR	15	SERVICE CALL CHECK	37
MANUAL COOKING	16-18	SPECIFICATION	38
SPEED COOKING	16	WARRANTY INFORMATION	39
CONVECTION COOKING	17		
MICROWAVE TIME COOKING	18		

4 Important Safety Instructions

When using electrical appliances basic safety precautions should be followed, including the following:

WARNING - To reduce the risk of burns, electric shock, fire, injury to persons or exposure to excessive microwave energy:

1. **READ ALL INSTRUCTIONS BEFORE USING THE APPLIANCE.**
2. Read and follow the specific **“PRECAUTIONS TO AVOID POSSIBLE EXPOSURE TO EXCESSIVE MICROWAVE ENERGY”** on page 2.
3. This appliance must be grounded. Connect only to properly grounded outlet. See **“GROUNDING INSTRUCTIONS”** on page 7.
4. Install or locate this appliance only in accordance with the provided installation instructions.
5. Some products such as whole eggs and sealed containers—for example, closed glass jars—are able to explode and should not be heated in this oven.
6. Use this appliance only for its intended use as described in this manual. Do not use corrosive chemicals or vapors in this appliance. This type of oven is specifically designed to heat, cook or dry food. It is not designed for industrial or laboratory use.
7. As with any appliance, close supervision is necessary when used by children.
8. Do not operate this appliance if it has a damaged cord or plug, if it is not working properly or if it has been damaged or dropped.
9. This appliance should be serviced only by qualified service personnel. Contact nearest Electrolux Authorized Servicer for examination, repair or adjustment.
10. Do not cover or block any openings on the appliance.
11. Do not store or use this appliance outdoors. Do not use this product near water—for example, near a kitchen sink, in a wet basement, near a swimming pool, or similar locations.
12. Do not immerse cord or plug in water.
13. Keep cord away from heated surfaces.
14. Do not let cord hang over edge of table or counter.
15. See door surface cleaning instructions on page 36.
16. To reduce the risk of fire in the oven cavity:
 - a. Do not overcook food. Carefully attend to appliance when paper, plastic or other combustible materials are placed inside the oven to facilitate cooking.
 - b. Remove wire twist-ties from paper or plastic bags before placing bag in oven.
 - c. **If materials inside the oven ignite, keep oven door closed, turn oven off and disconnect the power cord or shut off power at the fuse or circuit breaker panel.**
 - d. Do not use the cavity for storage purposes. Do not leave paper products, cooking utensils or food in the cavity when not in use.
17. Liquids, such as water, coffee or tea are able to be overheated beyond the boiling point without appearing to be boiling. Visible bubbling or boiling when the container is removed from the microwave oven is not always present. **THIS COULD RESULT IN VERY HOT LIQUIDS SUDDENLY BOILING OVER WHEN A SPOON OR OTHER UTENSIL IS INSERTED INTO THE LIQUID.**

To reduce the risk of injury to persons:

 - a. Do not overheat the liquid.
 - b. Stir the liquid both before and halfway through heating it.
 - c. Do not use straight-sided containers with narrow necks. Use a wide-mouthed container.
 - d. After heating, allow the container to stand in the microwave oven at least for 20 seconds before removing the container.
 - e. Use extreme care when inserting a spoon or other utensil into the container.
18. If the oven light fails, consult an ELECTROLUX AUTHORIZED SERVICER.

Important Safety Instructions 5

19. Do not operate any heating or cooking appliance beneath this appliance, except a properly installed electric wall oven listed on page 6.
20. Do not mount unit over or near any portion of a heating or cooking appliance, except a properly installed electric wall oven listed on page 6.
21. Do not mount over a sink.
22. Do not store anything directly on top of the appliance surface when the appliance is in operation.

SAVE THESE INSTRUCTIONS

6 Unpacking & Installation Instruction

UNPACKING AND EXAMING YOUR OVEN

1. Remove all packing materials from inside the oven cavity. **Do not remove the Waveguide Cover**, which is located on the right cavity wall. Read and SAVE this Use and Care Guide and the High Speed Convection Microwave Oven Cookbook.
2. Remove the feature sticker, if there is one, from the outside of the door.

Check the oven for any damage, such as misaligned or bent door, damaged door seals and sealing surfaces, broken or loose door hinges and latches and dents inside the cavity or on the door. If there is any damage, do not operate the oven and contact your dealer or ELECTROLUX AUTHORIZED SERVICER.

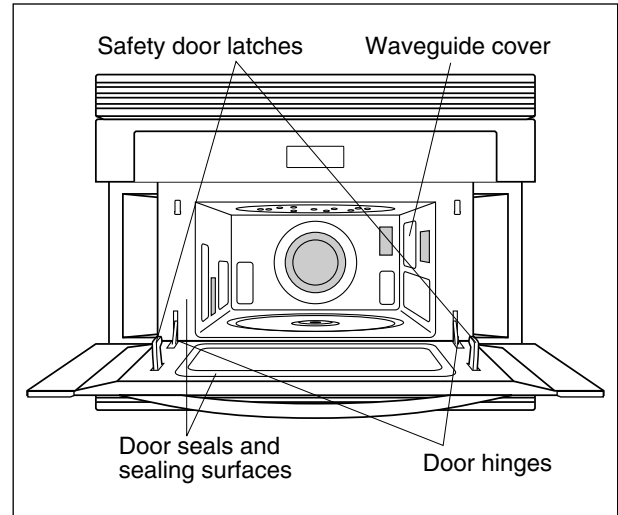

CHOOSING A LOCATION FOR YOUR OVEN

You will use your oven frequently, so plan its location for ease of use. The oven must be placed on a countertop which is a minimum of 36 inches from the floor. Allow at least 2 inches on the sides, top and at the rear of the oven for air circulation. Be sure to position oven so that the rear cannot be touched inadvertently.

Your oven can be built into a cabinet or wall by itself or above the electric wall oven E30EW75DSS1.

Note for built-in kits:

See sketch 1 for proper location when building in above the specified wall oven. Carefully follow the wall oven installation instructions. Be sure that the clearance of the floor between the wall oven and the high speed oven is minimum of 3 inches.

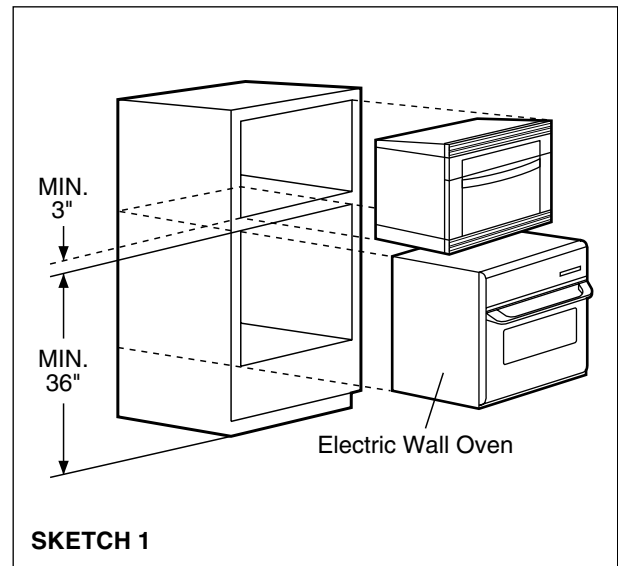

Grounding Instructions 7

This appliance must be grounded. This oven is equipped with a cord having a grounding wire with a grounding plug. It must be plugged into a wall receptacle that is properly installed and grounded in accordance with the National Electrical Code and local codes and ordinances. In the event of an electrical short circuit, grounding reduces risk of electric shock by providing an escape wire for the electric current.

WARNING – Improper use of the grounding plug can result in a risk of electric shock.

ELECTRICAL REQUIREMENTS

The electrical requirements are a 240 volt 60 Hz, AC only, 15 amp. protected electrical supply. It is recommended that a separate circuit serving only this appliance be provided. The 240 volt circuit is absolutely necessary for optimum cooking performance.

The oven is equipped with a 3-prong grounding plug. It must be plugged into a wall receptacle that is properly installed and grounded.

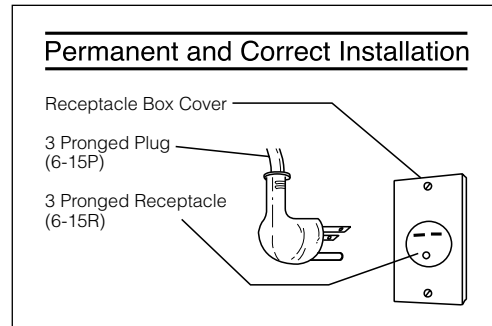

EXTENSION CORD

If it is necessary to use an extension cord, use only a 3-wire extension cord that has a 3-blade grounding plug and a 3-slot receptacle that will accept the plug on the high speed oven. The marked rating of the extension cord should be AC 240 volt, 15 amp. or more.

Be careful not to drape the cord over the countertop or table where it can be pulled on by children or tripped over accidentally.

NOTES:

1. If you have any questions about the grounding or electrical instructions, consult a qualified electrician or service person.
2. Neither Electrolux nor the dealer can accept any liability for damage to the oven or personal injury resulting from failure to observe the correct electrical connection procedures.

RADIO OR TV INTERFERENCE

Should there be any interference caused by the high speed oven to your radio or TV, check that the high speed oven is on a different electrical circuit, relocate the radio or TV as far away from the oven as feasible or check position and signal of receiving antenna.

8 Information You Need To Know

ABOUT YOUR OVEN

This Use and Care Guide is valuable: read it carefully and always save it for reference.

The Electrolux High Speed Convection Microwave Cookbook is a valuable asset. Check it frequently for cooking principles, techniques, hints and recipes.

NEVER use the oven without the turntable and support nor turn the turntable over so that a large dish could be placed in the oven. The turntable will turn both clockwise and counterclockwise.

ALWAYS have food in the oven when it is on to absorb the microwave energy.

When using the oven at power levels below 100%, you may hear the magnetron cycling on and off. It is normal for the exterior of the oven to be warm to the touch when cooking or reheating.

Condensation is a normal part of microwave cooking. Room humidity and the moisture in

food will influence the amount of moisture that condenses in the oven. Generally, covered foods will not cause as much condensation as uncovered ones. Vents on the oven back must not be blocked.

After using, the cooling fan may come on to cool the oven cavity. The display will show NOW COOLING, and you will hear the sound of the fan.

Unlike microwave-only ovens, your oven may become hot during cooking. Be cautious.

The oven is for food preparation only. It should not be used to dry clothes or newspapers.

The microwave capability of your oven is rated 1000 watts by using the IEC Test Procedure. In using microwave-only recipes or package directions, check food a minute or two before the minimum time and add time accordingly.

ABOUT MICROWAVE COOKING

- Arrange food carefully. Place thickest areas towards outside of dish.
- Watch cooking time. Cook for the shortest amount of time indicated and add more as needed. Food severely overcooked can smoke or ignite.
- Cover foods while cooking. Check recipe or cookbook for suggestions: paper towels, wax paper, microwave plastic wrap or a lid. Covers prevent spattering and help foods to cook evenly.
- Shield with small flat pieces of aluminum foil any thin areas of meat or poultry to prevent overcooking before dense, thick areas are cooked thoroughly.
- Stir foods from outside to center of dish once or twice during cooking, if possible.
- Turn foods over once during microwaving to speed cooking of such foods as chicken and hamburgers. Large items like roasts must be turned over at least once.
- Rearrange foods such as meatballs halfway through cooking both from top to bottom and from the center of the dish to the outside.
- Add standing time. Remove food from oven and stir, if possible. Cover for standing time which allows the food to finish cooking without overcooking.
- Check for doneness. Look for signs indicating that cooking temperatures have been reached.

Doneness signs include:

- Food steams throughout, not just at edge.
 - Center bottom of dish is very hot to the touch.
 - Poultry thigh joints move easily.
 - Meat and poultry show no pinkness.
 - Fish is opaque and flakes easily with a fork.
-

ABOUT CHILDREN

Children below the age of 7 should use the high speed oven with a supervising person very near to them. Between the ages of 7 and 12, the supervising person should be in the same room.

The child must be able to reach the oven comfortably; if not, he/she should stand on a sturdy stool.

At no time should anyone be allowed to lean or swing on the oven door.

Children should be taught all safety precautions: use potholders, remove coverings carefully, pay special attention to packages that crisp food because they may be extra hot.

Don't assume that because a child has mastered one cooking skill he/she can cook everything.

Children need to learn that the microwave oven is not a toy. See page 34 for Child Lock feature.

ABOUT FOOD

FOOD	DO	DON'T
Eggs, sausages, nuts, seeds, fruits & vegetables	<ul style="list-style-type: none"> • Puncture egg yolks before cooking to prevent "explosion". • Pierce skins of potatoes, apples, squash, hot dogs and sausages so that steam escapes. 	<ul style="list-style-type: none"> • Cook eggs in shells. • Reheat whole eggs. • Dry nuts or seeds in shells.
Popcorn	<ul style="list-style-type: none"> • Use specially bagged popcorn for the microwave oven. • Listen while popping corn for the popping to slow to 1 or 2 seconds or use special POPCORN pad. • Use a NordicWare® two-sided bacon/meat grill (grill side) made from heavy weight thermoset polyester when popping bagged microwave popcorn. 	<ul style="list-style-type: none"> • Pop popcorn in regular brown bags or glass bowls. • Exceed maximum time on popcorn package.
Baby food	<ul style="list-style-type: none"> • Transfer baby food to small dish and heat carefully, stirring often. Check temperature before serving. • Put nipples on bottles after heating and shake thoroughly. "Wrist" test before feeding. 	<ul style="list-style-type: none"> • Heat disposable bottles. • Heat bottles with nipples on. • Heat baby food in original jars.
General	<ul style="list-style-type: none"> • Cut baked goods with filling after heating to release steam and avoid burns. • Stir liquids briskly before and after heating to avoid "eruption". • Use deep bowl, when cooking liquids or cereals, to prevent boilovers. 	<ul style="list-style-type: none"> • Heat or cook in closed glass jars or air tight containers. • Can in the microwave as harmful bacteria may not be destroyed. • Deep fat fry. • Dry wood, gourds, herbs or wet papers.

10 Information You Need To Know

ABOUT UTENSILS AND COVERINGS

It is not necessary to buy all new cookware. Many pieces already in your kitchen can be used successfully in your new High Speed Convection Microwave Oven. The chart below will help you decide what utensils and coverings should be used in each mode.

UTENSILS AND COVERINGS	MICROWAVE ONLY	CONVECTION, GRILL AND BAKE	ROAST
Aluminum foil	YES - Small flat pieces of aluminum foil placed smoothly on food can be used to shield areas from cooking or defrosting too quickly. Keep foil at least 1 inch from walls of oven.	YES - For shielding	YES - For shielding
Aluminum containers	NO	YES - Grill/Bake. No cover.	NO
Browning dish	YES - Do not exceed recommended preheating time. Follow manufacturer's directions.	NO	NO
Glass ceramic (Pyroceram®)	YES - Excellent	YES - Excellent	YES - Excellent
Glass, non-heat-resistant	NO	NO	NO
Lids, glass	YES	YES - Grill/Bake. No cover.	NO
Lids, metal	NO	YES - Grill/Bake. No cover.	NO
Metal cookware	NO	YES	YES - Do not use metal covering.
Metal, misc.: dishes with metallic trim, screws, bands, handles. Metal twist ties	NO	NO	NO
Oven cooking bags	YES - Good for large meats or foods that need tenderizing. DO NOT use metal twist ties.	YES - Grill/Bake. No cover.	YES - Do not use metal twist ties.
Paper plates	YES - For reheating	NO	NO
Paper, ovenable	YES	YES - For temperatures up to 400°F. Do not use for Grill.	YES - For temperatures up to 400°F.
Microwave-safe plastic containers	YES - Use for reheating and defrosting. Some microwave-safe plastics are not suitable for cooking foods with high fat and sugar content. Follow manufacturer's directions.	NO	NO
Plastic, Thermoset®	YES	YES - Are heat resistant up to 425°F. Do not use for Grill.	

Information You Need To Know 11

UTENSILS AND COVERINGS	MICROWAVE ONLY	CONVECTION, GRILL AND BAKE	ROAST
Plastic wrap	YES - Use brands specially marked for microwave use. DO NOT allow plastic wrap to touch food. Vent so steam can escape.	NO	NO
Pottery, porcelain stoneware	YES - Check manufacturer's recommendation for being microwave safe.	YES	YES - Must be microwave safe AND ovenable.
Styrofoam	YES - For reheating	NO	NO
Wax paper	YES - Good covering for cooking and reheating.	NO	NO
Wicker, wood, straw	YES - May be used for short periods of time. Do not use with high fat or high sugar content foods. Could char.	NO	NO

DISH CHECK If you wish to check if a dish is safe for microwaving, place the empty dish in the oven and microwave on HIGH for 30 seconds. If the dish becomes very hot, do NOT use it for microwaving.

AUTOMATIC COOKING Use the recommended container in the cooking chart in this operation manual, cookbook and display.

ACCESSORIES There are many microwave accessories available for purchase. Evaluate carefully before you purchase so that they meet your needs. A microwave-safe thermometer will assist you in determining correct doneness and assure you that foods have been cooked to safe temperatures when using microwave-only cooking.

Electrolux is not responsible for any damage to the oven when accessories are used.

CAUTION When using ROAST or during automatic cooking, some metal baking utensils may cause arcing when they come in contact with the turntable, oven walls or accessory racks. Arcing is a discharge of electricity that occurs when microwaves come in contact with metal.

If arcing occurs, place a heat resistant dish, such as a Pyrex pie plate or oven-glass plate, between the pan and the turntable or rack. If arcing continues to occur, discontinue using that pan.

12 Information You Need To Know

ABOUT SPEED COOKING AND CONVECTION COOKING

- The oven cabinet, cavity, door, accessories and dishes will become hot. To PREVENT BURNS, use thick oven gloves when removing the food or turntable from the oven.
- When preheating, the turntable can be left in or removed. When using the high rack for 2 shelf baking in a preheated oven, it is easier to remove the turntable for preheat. Place high rack on turntable along with foods. When preheat is over, open oven door and quickly place turntable, high rack and foods to be baked inside.
- Do not cover turntable, low rack or high rack with aluminum foil. It interferes with air flow that cooks food.
- Round pizza pans are excellent cooking utensils for many items. Choose pans that do not have extended handles.
- Using a preheated low rack can give a grilled appearance to steaks and hot dogs.

ABOUT SAFETY

- Check foods to see that they are cooked to the United States Department of Agriculture's recommended temperatures.
- Avoid steam burns by directing steam away from the face and hands. Slowly lift the farthest edge of a dish's covering and carefully open popcorn and oven cooking bags away from the face.
- Stay near the oven while it's in use and check cooking progress frequently so that there is no chance of overcooking food.
- NEVER use the cavity for storing cookbooks or other items.
- Select, store and handle food carefully to preserve its high quality and minimize the spread of foodborne bacteria.
- Keep waveguide cover clean. Food residue can cause arcing and/or fires.
- Use care when removing items from the oven so that the utensil, your clothes or accessories do not touch the safety door latches.
- Keep aluminum foil used for shielding at least 1 inch away from walls, ceiling and door.

TEMP	FOOD
160°F	For fresh pork, ground meat, boneless white poultry, fish, seafood, egg dishes and frozen prepared food.
165°F	For leftover, ready-to-reheat refrigerated, and deli and carry-out "fresh" food.
170°F	White meat of poultry.
180°F	Dark meat of poultry.

To test for doneness, insert a meat thermometer in a thick or dense area away from fat or bone. NEVER leave the thermometer in the food during cooking, unless it is approved for microwave use.

- ALWAYS use potholders to prevent burns when handling utensils that are in contact with hot food. Enough heat from the food can transfer through utensils to cause skin burns.

OVEN PARTS

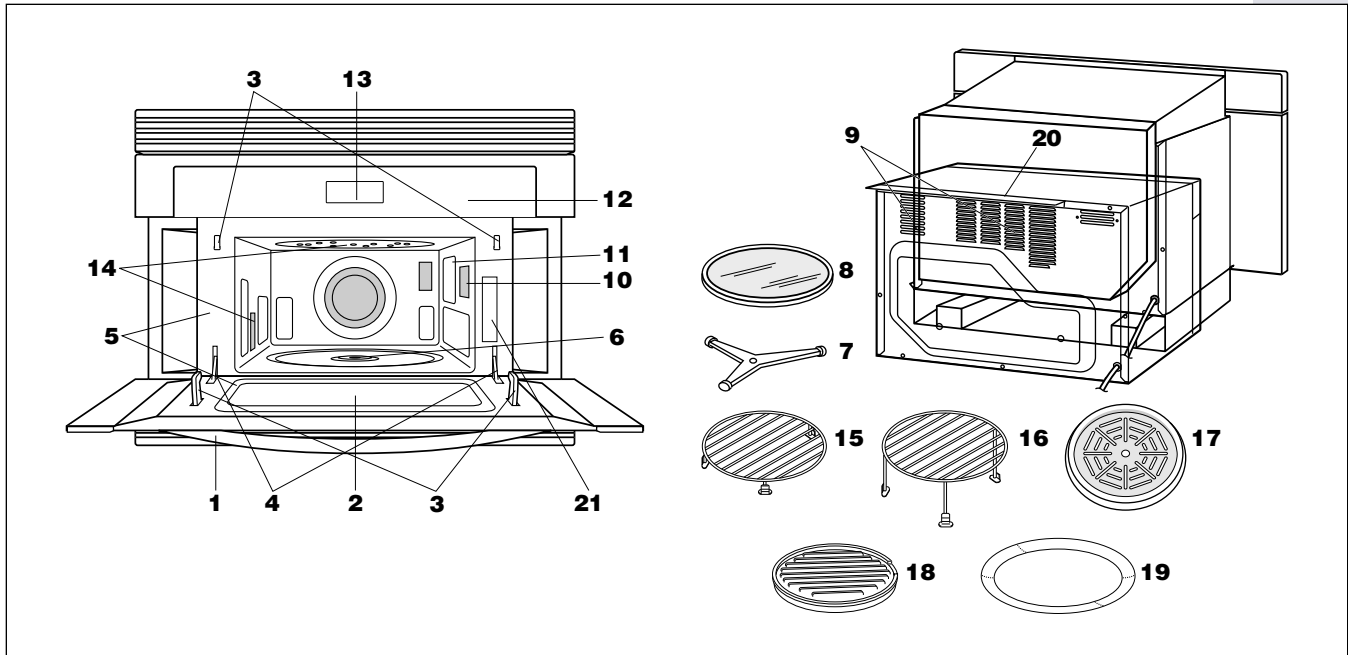

1 Door handle

To open the door, pull the handle down and forward. Never hold the door handle when moving the oven.

2 Oven door with see-through window

3 Safety door latches

The oven will not operate unless the door is securely closed.

4 Door hinges

5 Door seals and sealing surfaces

6 Turntable motor shaft

7 Removable turntable support

Carefully place the turntable support in the center of the oven floor.

After cooking, always clean the turntable support, especially around the rollers. These must be free from food splashes and grease. Built-up splashes or grease may overheat and cause arcing, begin to smoke or catch fire.

8 Removable turntable

Place the turntable on the turntable support securely. The turntable will rotate clockwise or counterclockwise.

Only remove for cleaning.

9 Ventilation openings

10 Oven light

It will light when oven is operating or door is open.

11 Waveguide cover: DO NOT REMOVE.

12 Glass Touch panel

13 Time display: 99 minutes, 99 seconds

14 Convection air openings

15 Removable low rack

16 Removable high rack

17 Splash guard

18 Bacon rack

19 Pizza pan

20 Ventilation cover: DO NOT REMOVE.

21 Serial plate

14 Part Names

INTERACTIVE DISPLAY

The Interactive Display spells out operating steps and shows cooking hints. When HELP is flashing, touch HELP to read a specific hint which may assist you.



Speed Grill Convection Micro Cook

Each indicator shows what function is in progress.

CONTROL PANEL

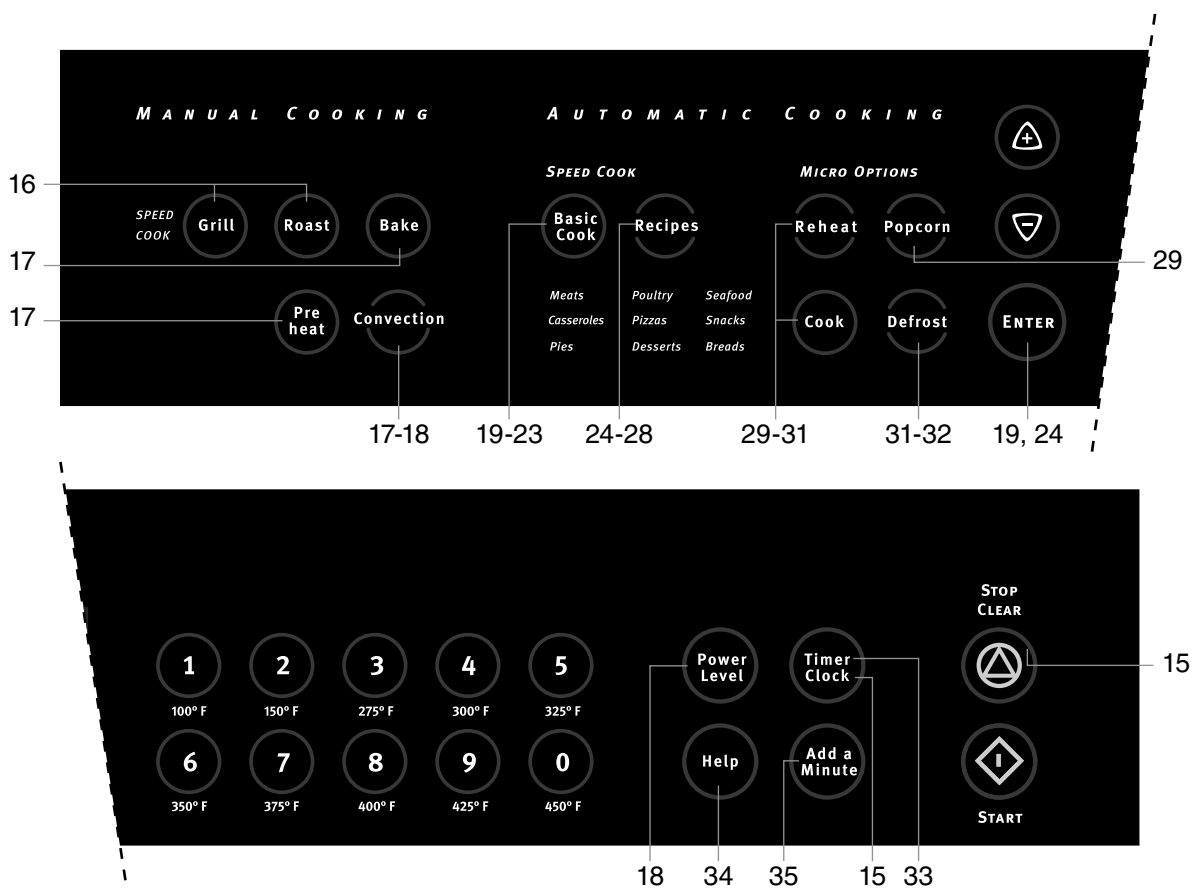



Number next to the control panel illustration indicates pages on which there are feature descriptions and usage information.

- Before operating your new oven make sure you read and understand this operation manual completely.
- Before the oven can be used, follow these procedures:
 1. Plug in the oven. Close the door. The oven display will show **WELCOME**.
 2. Touch the **STOP/CLEAR** pad. will appear.
 3. Set clock. See below.
 4. Follow directions on page 34 for using the Refresh Cycle.

TO SET THE CLOCK

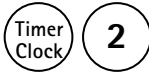
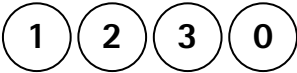
- Suppose you want to enter the correct time of day 12:30.

PROCEDURE	
1. Touch Clock and number pad 2.	
2. Enter the correct time of day by touching the numbers in sequence.	
3. Touch Clock again.	

This is a 12 hour clock. If you attempt to enter an incorrect clock time, **ERROR** will appear in the display. Touch the **STOP/CLEAR** pad and re-set the clock.

- If the electrical power supply to your oven should be interrupted, the display will intermittently show **WELCOME** after the power is reinstated. If this occurs during cooking, the program will be erased. The time of day will also be erased. Simply touch **STOP/CLEAR** and reset the clock for the correct time of day.

STOP/CLEAR

Touch the **STOP/CLEAR** to:

1. Erase if you make a mistake during programming.
2. Cancel timer.
3. Stop the oven temporarily during cooking.
4. Return the time of day to the display.
5. Cancel a program during cooking, touch twice.

16 Manual Cooking

SPEED COOKING

Your oven has 3 special speed cooking modes.

Caution: The oven cabinet, cavity, door, turntable, turntable support, rack and dishes will become hot. To PREVENT BURNS, use thick oven gloves when removing the food or turntable.

1. GRILL

Use the **Grill** setting for steaks, chops, chicken pieces and many other foods you would normally grill that are not included in Basic Cook on pages 20-23. **Grill** is a preprogrammed setting that cooks fast with a high temperature and maximum speed hot air circulation. Only actual cooking time is entered; the oven signals when it is preheated to 450°F. The oven temperature cannot be changed.

- Suppose you want to grill a steak for 15 minutes.

PROCEDURE	
1. Touch Grill .	(Grill)
2. Enter cooking time.	(1) (5) (0) (0)
3. Touch START . Preheat starts. No food in oven.	(START)
When the oven reaches the programmed temperature, a signal will sound once*.	
4. Open the door. Place food in the oven. Close the door. Touch START .	(START)

* If the oven door is not opened, the oven will automatically hold at the preheat temperature for 30 minutes. After this time has elapsed, an audible signal will sound and the oven will turn off.

NOTE:

1. You can grill foods without preheat. To program grill without preheat, touch **Grill** twice at step 1.
2. Foods cook quickly using **Grill**. Check often to ensure desired results.
3. Either the high or low rack may be used. The high rack grills food the fastest. Place the splash guard on the turntable with either of the racks over it.

2. ROAST

Use the **Roast** setting for poultry, meat, fish or other foods you would normally roast that are not included in Basic Cook on pages 20-23. **Roast** is a preprogrammed setting that roasts with high speed air circulation, 300°F. and a boost of microwave power. The cooking time is reduced 33% to 50% compared with typical ovens. No preheat is necessary. Use the low rack over the splash guard so all sides are cooked with a minimum of moisture loss. No pan put on low rack.

- Suppose you want to roast a 3 pound beef rib roast for 20 minutes.

PROCEDURE	
1. Touch Roast .	(Roast)
2. Enter cooking time.	(2) (0) (0) (0)
3. Touch START .	(START)

NOTE:

1. The temperature can be changed, however the microwave power cannot.

To change the temperature, touch **Roast** twice at step 1. When the display shows **SELECT COOKING TEMP**, touch desired temperature pad.

2. When you roast a food for the first time, enter 1/2 the usual roasting time and check doneness carefully during the cooking. If extra time is needed, add and continue to check often until the desired doneness has been achieved.
3. When using **Roast**, some metal baking utensils may cause arcing when they come in contact with the turntable, oven walls or accessory racks. Arcing is a discharge of electricity that occurs when microwaves come in contact with metal.

If arcing occurs, place a heat resistant dish, such as a Pyrex pie plate or oven-glass plate, between the pan and the turntable or rack. If arcing continues to occur, discontinue use for roast cooking.

3. BAKE

Use the **Bake** setting for cakes, breads and many other foods you would normally bake that take longer than 20 minutes in a conventional oven and are not included in Basic Cook on pages 20-23. **Bake** is a preprogrammed setting that makes it easy to bake with high speed air circulation at 325°F.

The baking time is 25% to 33% less than in a conventional oven. No preheat is necessary. Use the low rack.

- Suppose you want to bake a cake for 25 minutes.

PROCEDURE	
Touch Bake .	







CONVECTION COOKING





The **Convection** setting is used when conventional time and temperature are desired.

During convection cooking, hot air is circulated throughout the oven cavity to brown and crisp foods evenly. This oven can be programmed for ten different temperatures for up to 99 minutes, 99 seconds.

TO COOK WITH CONVECTION

- Suppose you want to cook at 350°F for 20 minutes.

PROCEDURE	
1. Touch Convection .	
2. Touch temperature pad.	 350°F
3. Enter cooking time.	   
4. Touch START .	

2. Enter cooking time.	   
3. Touch START .	









NOTE:

1. The temperature can be changed. To change the temperature, touch **Bake** twice at step 1. When the display shows **SELECT COOKING TEMP**, touch desired temperature pad. When adapting recipes or package directions, reduce the suggested baking temperature by 25°F.
2. When you bake for the first time, enter 2/3s of the usual baking time and check carefully throughout the baking. If extra time is needed, add and continue to check often until the desired doneness has been achieved.

TO PREHEAT AND COOK WITH CONVECTION

Your oven can be programmed to combine preheating and convection cooking. You can preheat to the same temperature as the convection temperature or change to a higher or lower temperature.

- Suppose you want to preheat and then cook 25 minutes at 350°F.

PROCEDURE	
1. Touch Preheat .	
2. Select preheat temperature.	 350°F
3. Touch START for Preheat or enter cooking time for Convection .	   
4. Touch START . Preheat starts. No food in oven.	
When the oven reaches the programmed temperature, a signal will sound once*.	
5. Open the door. Place food in the oven. Close the door. Touch START .	

18 Manual Cooking

* If the oven door is not opened, the oven will automatically hold at the preheat temperature for 30 minutes. After this time has elapsed, an audible signal will sound, and the oven will turn off.

NOTE:

1. To program only preheat, touch the **START** pad

after step 2. Preheating will start. When the oven reaches the programmed temperature, follow the indicated message.

2. To preheat and cook with the different temperatures, touch **Convection** and enter the temperature after Step 2.

MICROWAVE TIME COOKING

Your oven can be programmed for 99 minutes 99 seconds (99.99). Always enter the seconds after the minutes, even if they are both zeros.

- Suppose you want to cook for 5 minutes at 100%.

PROCEDURE		
1. Enter cooking time.	5	0 0
2. Touch START .	START	

- Suppose you want to defrost for 5 minutes at 30%.

PROCEDURE		
1. Enter cooking time.	5	0 0
2. Touch Power Level 8 times or hold down until the desired power level appears.	Power Level x 8	
3. Touch START .	START	

TO SET POWER LEVEL

There are eleven preset power levels.

Using lower power levels increases the cooking time which is recommended for foods such as cheese, milk and long slow cooking of meats. Consult cookbook or recipes for specific recommendations.

If you wish to know the power level, simply touch **Power Level**. As long as your finger is touching **Power Level**, the power level will be displayed.

TOUCH POWER LEVEL PAD	APPROXIMATE PERCENTAGE OF POWER	COMMON WORDS FOR POWER LEVELS
Once	100%	High
Twice	90%	
3 times	80%	
4 times	70%	Medium High
5 times	60%	
6 times	50%	Medium
7 times	40%	
8 times	30%	Med Low/Defrost
9 times	20%	
10 times	10%	Low
11 times	0%	

SPEED COOKING

The 84 basic foods and 100 recipes are cooked with Electrolux's new high speed hot air system. Follow the directions below and those in the Interactive Display to ensure perfectly cooked foods.

CAUTION:







The oven cabinet, cavity, door, turntable, turntable support, rack and dishes will become hot. To PREVENT BURNS, use thick oven gloves when removing the food or turntable.

BASIC COOK

The 84 preprogrammed basic foods are grilled, roasted or baked to perfection. Note they are in nine categories. See the chart on pages 20-23 for the specific foods. There are 2 ways to select your favorite food. One is selecting from the food category and other is entering the specific food number.

OPERATION 1: Select food from the food category.







- Suppose you want to roast a 5 pound chicken.

PROCEDURE	
1. To select food category, touch Basic Cook repeatedly. See chart below. Touch Basic Cook 2 times to select the Poultry category. Note that the Poultry is lighted.	 x 2
2. Touch the UP or DOWN arrows to select desired food. (Ex: Touch the UP arrow 3 times for CHICKEN WHOLE.)	 or 
3. Touch desired numbers to enter quantity. (Ex: touch numbers 5 and 0 for 5.0 lb.)	 
4. Put chicken on low rack over splash guard in the oven.	
5. Touch START .	

TOUCH BASIC COOK	FOOD CATEGORY
Once	Meats
Twice	Poultry
3 times	Fish/Seafood
4 times	Casseroles
5 times	Pizzas
6 times	Appetizers/Snacks
7 times	Pies
8 times	Desserts
9 times	Cakes/Breads

OPERATION 2: Select food by entering the specific food number.

- Suppose you want to roast a 5 pound chicken (food number 17 - CHICKEN WHOLE).

PROCEDURE	
1. Touch Basic Cook .	
2. Enter desired food number from the chart on page 20-23. (Ex: Touch number 1 and 7 to select CHICKEN WHOLE.)	 
3. Touch ENTER .	
4. Touch desired numbers to enter quantity. (Ex: touch number 5 and 0 for 5.0 lb.)	 
5. Put chicken on low rack over splash guard in the oven.	
6. Touch START .	

NOTE:

- It may not be necessary to enter weight or quantity for some foods. It may be necessary to select 1 level or 2 levels. Follow the Interactive Display directions to ensure perfect cooking results.
- The Interactive Display also advises if a high rack or low rack is needed.

20 Automatic Cooking

3. When HELP is flashing, press **HELP** for additional information to assist you.
 4. You can adjust cooking time as you like. See AUTOMATIC COOKING TIME ADJUSTMENT on page 33.
 5. The Basic Cook numbers are from 1 to 84. See pages 20-23 for the desired basic cook and enter that number. Should you enter a number greater than 84, the display will show **ERROR**.
 6. If you attempt to enter more or less than the allowed amount as indicated in chart, an error message will appear in the display.
 7. Be sure to use the recommended container in the chart and Interactive Display.
- If arcing occurs, place a heat resistant dish (Pyrex pie plate, glass pizza dish or dinner plate) between the pan and the turntable or rack. If arcing occurs with other metal baking utensils, discontinue their use for cooking.

BASIC COOK CHART

MEAT					
NO.		AMOUNT	RACK	CONTAINER	SPLASH GUARD
BEEF					
1	Frankfurters*	1 - 6 pcs		Pizza pan	
2	Hamburgers 1/4 lb each* medium, well	2 - 6 pcs	Low		Yes
3	Meat loaf	1 - 2 lb		Glass loaf dish	
4	Roast tender cut, boneless rare, medium	2.5 - 4 lb	Low		Yes
5	Steaks, bone-in 1-inch thick* rare, medium	1 - 3 lb	Low		Yes
6	Steaks, boneless 1-inch thick* rare, medium	.5 - 2 lb	Low		Yes
LAMB					
7	Chops, bone-in 3/4-1-inch thick medium	.5 - 1.5 lb	Low		Yes
8	Roast, boneless medium	2.5 - 4 lb	Low		Yes
PORK					
9	Chops, bone-in 1/2-3/4-inch thick*	.5 - 2 lb	Low		Yes
10	Chops, boneless 1-inch thick*	.3 - 2 lb	Low		Yes
11	Roast, loin boneless*	2 - 3.5 lb	Low		Yes
12	Roast, tenderloin*	1.2 - 2 lb		Pizza pan	
13	Sausage*	.3 - 1 lb		Pizza pan	
14	Smoked ham slice	1 slice	Low		Yes

* This food choice requires a preheated oven. Be sure to wait until the preheat is over before putting the food in the oven.

BASIC COOK CHART (Cont.)

POULTRY						
NO.			AMOUNT	RACK	CONTAINER	SPLASH GUARD
CHICKEN						
15	Breasts, boneless*		.5 - 2 lb		Pizza pan	
16	Pieces, bone-in		.5 - 3 lb	Low		Yes
17	Whole		2.5 - 7 lb	Low		Yes
CONVENIENCE CHICKEN						
18	Nuggets, frozen*	1 level	.3 - 1.3 lb		Pizza pan	
		2 levels	1.4 - 2 lb	High	2 pizza pans	
19	Nuggets, refrigerated*	1 level	.3 - 1.3 lb		Pizza pan	
		2 levels	1.4 - 2 lb	High	2 pizza pans	
20	Patties, frozen	1 level*	.3 - 1.3 lb		Pizza pan	
		2 levels*	1.4 - 2 lb	High	2 pizza pans	
21	Patties, refrigerated	1 level*	.3 - 1.3 lb		Pizza pan	
		2 levels*	1.4 - 2 lb	High	2 pizza pans	
22	Pieces, bone-in frozen	1 level*	.5 - 1.5 lb		Pizza pan	
		2 levels*	1.6 - 3 lb	High	2 pizza pans	
23	Tenders, frozen	1 level*	.3 - 1.3 lb		Pizza pan	
		2 levels*	1.4 - 2 lb	High	2 pizza pans	
24	Tenders, refrigerated	1 level*	.3 - 1.3 lb		Pizza pan	
		2 levels*	1.4 - 2 lb	High	2 pizza pans	
25	Wings, frozen	1 level*	.5 - 2 lb		Pizza pan	
		2 levels*	2.1 - 3 lb	High	2 pizza pans	
26	Wings, refrigerated	1 level*	.5 - 2 lb		Pizza pan	
		2 levels*	2.1 - 3 lb	High	2 pizza pans	
TURKEY						
27	Breast, bone-in*		3 - 6 lb	Low		Yes
28	Breast, boneless		1.5 - 3 lb	Low		Yes
FISH/SEAFOOD						
29	Fillets*		.3 - 1.5 lb	High	Pizza pan	
30	Pieces, prepared frozen	1 level*	.3 - 1.5 lb		Pizza pan	
		2 levels*	1.6 - 2.5 lb	High	2 pizza pans	
31	Shellfish*		.3 - 1.5 lb	High	Pizza pan	
32	Steaks, 1-inch thick*		.5 - 1.5 lb	High	Pizza pan	
33	Sticks, prepared frozen	1 level*	.3 - 1.3 lb		Pizza pan	
		2 levels*	1.4 - 1.5 lb	High	2 pizza pans	

* This food choice requires a preheated oven. Be sure to wait until the preheat is over before putting the food in the oven.

22 Automatic Cooking

BASIC COOK CHART (Cont.)

CASSEROLES					
NO.			AMOUNT	RACK	CONTAINER
34	Baked	1 level	1		8-inch square dish
35	Lasagna	2 levels	2	High	2 (8-inch) square dishes
36	Macaroni and Cheese	1 level	1		8-inch square dish
		2 levels	2	High	2 (8-inch) square dishes
37	Real baked potatoes*		1 - 4		Pizza pan
PIZZA					
38	Boboli		1 pizza	Low	
39	Deli fresh*		1 pizza	Low	
40	Pizza crust, from a mix*		1 pizza	Low	Pizza pan
41	Pizza crust, refrigerated*		1 pizza	Low	Pizza pan
42	Regular crust, frozen*		1 pizza	Low	
43	Reheat, refrigerated leftover		1 - 4 slices	Low	
44	Rising crust, frozen*		1 pizza	High	
APPETIZER SNACKS FROZEN					
45	Bagel bites*		7 - 14 oz	Low	Pizza pan
46	Burritos or Chimichangas*		1 - 4 pcs		Pizza pan
47	Cheese sticks*		8 - 10 oz	Low	Pizza pan
48	Corn dogs*		1 - 6 pcs		Pizza pan
49	Eggplant sticks*		6 - 10 oz	Low	Pizza pan
50	Egg rolls*		1 - 4 pcs		Pizza pan
51	French fries	1 level*	.3 - 1 lb		Pizza pan
		2 levels*	2 lb	High	2 pizza pans
52	Hash brown potato patties	1 level*	1 - 6 patties		Pizza pan
		2 levels*	12 patties	High	2 pizza pans
53	Mini egg rolls*		3 - 9 pcs		Pizza pan
54	Mini tacos*		10 - 12 oz	Low	Pizza pan
55	Onion rings*	1 level*	.3 - .6 lb		Pizza pan
		2 levels*	.7 - 1 lb	High	2 pizza pans
56	Pocket sandwiches*		1 - 4 pcs		Pizza pan
57	Sausage and biscuits*		2 - 6 pcs		Pizza pan
58	Taquitos*		24 oz	Low	Pizza pan
59	Tater tots	1 level*	.3 - 1 lb		Pizza pan
		2 levels*	2 lb	High	2 pizza pans
60	Toasted raviolis		12 - 15 oz	Low	Pizza pan

* This food choice requires a preheated oven. Be sure to wait until the preheat is over before putting the food in the oven.

BASIC COOK CHART (Cont.)

PIES				
NO.		AMOUNT	RACK	CONTAINER
61	Cobbler, frozen	1	Low	Metal pan
62	Pie crust in glass dish*	1	Low	Glass pie plate
63	Pie crust in metal pan*	1		Metal pie pan
64	Pie, frozen fruit	1	Low	Metal pie pan
DESSERTS				
65	Brownies from a mix	2 levels	High	2 (8-inch) square pans
66	Cookies, frozen baked at 350°F	1 - 2 levels	1 level on low rack 2 levels on turntable and high rack	Pizza pan
67	Cookies, frozen baked at 375°F*	1 - 2 levels		Pizza pan
68	Cookies, refrigerated baked at 325°F*	1 - 2 levels		Pizza pan
69	Cookies, refrigerated baked at 350°F*	1 - 2 levels		Pizza pan
CAKES/BREADS				
CAKE				
70	Angel food cake from a mix	1		Tube pan
71	Bundt from a mix, baked at 350°F	1	Low	Bundt pan
72	Bundt from a mix, baked at 375°F	1	Low	Bundt pan
73	Layer from a mix*	1 - 2 layers	1 layer on turntable 2 layers on turntable and high	8-inch pan(s)
74	Cupcakes from a mix*	2 levels	High	2 6-cup muffin pans
QUICK BREAD				
75	Biscuits from a mix	1 level	Low	Pizza pan
76	Biscuits, frozen*	1 - 2 levels	1 level on low rack 2 levels on turntable and high	Pizza pan
77	Biscuits, refrigerated*	1 - 2 levels		Pizza pan
78	Crescent rolls, refrigerated	1 package		Pizza pan
79	Loaf from a mix	1 loaf		Loaf pan
80	Muffins from a mix*	2 levels	High	2 (6-cup) muffin pans
81	Sweet rolls, refrigerated*	1 package	Low	Pizza pan
YEAST BREAD				
82	Breadsticks, refrigerated	1 package	High	2 pizza pans
83	Garlic loaf, frozen	10 oz		Pizza pan
84	Loaf, refrigerated	1		Pizza pan

* This food choice requires a preheated oven. Be sure to wait until the preheat is over before putting the food in the oven.





24 Automatic Cooking

RECIPES

There are 100 great recipes in the ELECTROLUX HIGH SPEED CONVECTION MICROWAVE OVEN COOKBOOK. All recipes are preprogrammed with Electrolux's new technology with high speed hot air, so you can get perfect result in a shorter time. Note they are in nine categories. See the chart on pages 25-28 and follow the directions in the cookbook. There are 2 ways to select your favorite recipe. One is selecting from the food category and other is the entering the specific recipe number.

OPERATION 1: Select recipe from food category.



- Suppose you want to cook Deluxe Roasted Chicken.

PROCEDURE	
1. To select food category, touch Recipes repeatedly. See chart below. Touch Recipes 2 times to select the Poultry category. Note that the Poultry is lighted.	 x 2
2. Touch the UP or DOWN arrows to select desired recipe. (Ex: Touch the UP arrow 4 times for DELUXE ROASTED CHICKEN.)	 or 
3. Follow the display and the cookbook instructions.	
4. Touch START .	

TOUCH RECIPES	FOOD CATEGORY
Once	Meats
Twice	Poultry
3 times	Fish/Seafood
4 times	Casseroles
5 times	Pizzas
6 times	Appetizers/Snacks
7 times	Pies
8 times	Desserts
9 times	Cakes/Breads

OPERATION 2: Select recipe by entering the specific recipe number.

- Suppose you want to cook Deluxe Roasted Chicken. (Recipe number 20.)

PROCEDURE	
1. Touch Recipes .	
2. Enter desired food number from the chart. (Ex: Touch number 2 and 0 to select DELUXE ROASTED CHICKEN.)	
3. Touch ENTER .	
4. Follow the display and the cookbook instructions.	
5. Touch START .	

NOTE:

1. The Interactive Display also advises if a high rack or low rack is needed.
2. When **HELP** is flashing, press **HELP** for additional information to assist you.
3. You can adjust cooking time as you like. See AUTOMATIC COOKING TIME ADJUSTMENT on page 33.
4. The Recipe numbers are from 1-100. See pages 25-28 for the desired recipe and enter that number. Should you enter a number greater than 100, the display will show **ERROR**.
5. Be sure to use the recommended container in the cookbook and Interactive Display. If arcing occurs, place a heat resistant dish (Pyrex pie plate, glass pizza dish or dinner plate) between the pan and the turntable or rack. If arcing occurs with other metal baking utensils, discontinue their use for cooking.

RECIPES

MEAT				
NO.	FOOD	RACK	CONTAINER	SPLASH GUARD
1	Apricot Pork Roast	Low		Yes
2	Barbecued Steaks	Low		Yes
3	Beef and Bean Wheels	Low	Pizza pan	
4	Chinese Pork Chops	Low	10-inch square casserole	
5	Crispy Franks	Low	Pizza pan	
6	Glazed Ham Slice	Low	10-inch square casserole	
7	Glazed Veal Chops	Low		Yes
8	Heavenly Hamburgers	Low		Yes
9	Meat Loaf Surprise		9x5 glass loaf dish	
10	Oriental Flank Steak*	Low		Yes
11	Pork Tenderloin with Herbs		Pizza pan	
12	Sour Cream Burgers	Low		Yes
13	Spareribs with Plum Glaze	Low	10-inch square casserole (1-2 stage)	Yes (3-4 stage)
14	Steak Kabobs	Low		Yes
15	Sweet and Sour Lamb Chops	Low	2 qt casserole	
16	Zesty Pork Tenderloin		Pizza pan	
POULTRY				
17	Apple Turkey Breast	Low	8-inch square glass dish	
18	Caribbean Chicken Breasts	Low		Yes
19	Crunchy Garlic Chicken	Low	3 qt casserole	
20	Deluxe Roasted Chicken	Low		Yes
21	Herb Grilled Chicken	Low		Yes
22	Honey Mustard Drumsticks	Low		Yes
23	Mustard and Mayo Chicken	Low		Yes
24	Onion Chicken Fingers*	Low	Pizza pan	
25	Roasted Turkey Breast	Low		Yes
26	Savory Roast Chicken	Low		Yes
27	Sesame Oven-Fried Chicken	Low	Pizza pan	
28	Stuffed Chicken Breasts		8-inch square glass dish	

* This food choice requires a preheated oven. Be sure to wait until the preheat is over before putting the food in the oven.

26 Automatic Cooking

RECIPES (Cont.)

FISH/SEAFOOD				
NO.	FOOD	RACK	CONTAINER	SPLASH GUARD
29	Fish Steaks with Herbs	Low	Pizza pan	
30	Italian Shrimp*	High	Pizza pan	
31	Lemon buttered Sole*	Low	10-inch square casserole	
32	Old Bay Grilled Fish*	High	Pizza pan	
33	Pineapple Salsa Swordfish	Low	Pizza pan	
34	Salmon with Basil Sauce	Low	Pizza pan	
35	Salmon with Tomatoes*	Low	10-inch square casserole	
36	Savory Baked Fish*	High	Pizza pan	
37	Scallop Kabobs*	High	Pizza pan	
38	Shrimp de Jonghe*	Low	10-inch round casserole	
39	Spicy Shrimp*	High	Pizza pan	
40	Teriyaki Fish Fillets*	High	Pizza pan	
CASSEROLE				
41	Baked Shrimp Salad*	Low	9-inch glass pie plate	
42	Chicken Linguine Casserole		8-inch square glass dish	
43	Citrus Treasure Fish*	Low	2.5 qt casserole	
44	Crustless Chicken Quiche	Low	9-inch pie plate	
45	Grilled Vegetables	2 levels High	2 pizza pans	
46	Macaroni and Blue Cheese		8-inch square glass dish	
47	Mexicali Corn Pudding	Low	10-inch square casserole	
48	Mushroom Lasagna	2 levels High	2 (8-inch) square glass dishes	
49	Party Roasted Potatoes	Low	Pizza pan	
50	Pasta with Squash and Shallots	Low	Pizza pan	
51	Stuffed Peppers		10-inch casserole	
52	Tamale Casserole		2 qt casserole	
PIZZA				
53	Brie and Cranberry Pizza*	Low	Pizza pan	
54	Chewy Pizza Bread*	Low	8-inch square glass dish	
55	Grecian Potato Pizza*	Low	Pizza pan	
56	Hail Caesar Pizza*	Low	Pizza pan	
57	Hawaiian Barbeque Pizza*	Low		
58	Pesto Pizza*	Low	Pizza pan	

* This food choice requires a preheated oven. Be sure to wait until the preheat is over before putting the food in the oven.

RECIPES (Cont.)

APPETIZER AND SNACKS				
NO.	FOOD	RACK	CONTAINER	SPLASH GUARD
59	Artichoke Crab Spread*	Low	9-inch glass pie plate	
60	Bean and Cheese Dip		9-inch glass pie plate	
61	Buffalo Chicken Wings	Low	Pizza pan	
62	Cheesy Spinach Nuggets 2 levels	High	2 pizza pans	
63	Grilled Portabella Appetizers*	Low		
64	Pistachio Camembert Tart		Pizza pan	
65	Rosy Baked Brie	Low	Flat glass dish	
66	Smoky Pigs in Blankets 2 levels	High	2 pizza pans	
67	Spicy Appetizer Nuts	Low	Pizza pan	
68	Veggie Nachos	Low	10-inch glass pie plate	
PIE/PASTRY				
69	Apple Berry Pie*		9-inch pie plate	
70	Caramel Pecan Pie*	Low	9-inch pie plate	
71	Coconut Oatmeal Pie	Low	9-inch pie plate	
72	Cracker Pie*	Low	9-inch pie plate	
73	Fresh Fruit Tart*	Low	Pizza pan	
74	Fudge Brownie Pie	Low	9-inch pie plate	
75	Graham Cracker Pie*	Low	9-inch pie plate	
76	Pear Praline Pie	Low	9-inch pie plate	
DESSERTS				
77	Autumn Treasure Cookies 2 levels	High	2 pizza pans	
78	Baked Apples Imperial		2 qt casserole	
79	Brownie Pizza*	Low	Pizza pan	
80	Carousel Crackles 2 levels	High	2 pizza pans	
81	Cookie Apple Cobbler*	Low	8-inch square glass dish	
82	Gingered Peach and Pear Crisp*	Low	8-inch round glass dish	
83	Maple Bread Pudding	Low	8-inch square glass dish	
84	Pumpkin Bars 2 levels	High	2 (8-inch) square pans	

* This food choice requires a preheated oven. Be sure to wait until the preheat is over before putting the food in the oven.

28 Automatic Cooking

RECIPES (Cont.)

CAKES/BREADS				
NO.	FOOD	RACK	CONTAINER	SPLASH GUARD
85	Banana Apricot Bran Bread	Low	9x5-inch glass loaf dish	
86	Banana Carrot Muffins	2 levels	High	2 (6-cup) muffin pans
87	Banana Streusel Loaf		9x5-inch glass loaf dish	
88	Blueberry Monkey Bread	Low	8-inch square glass dish	
89	Cinnamon Date Scones	2 levels	High	2 pizza pans
90	Cinnamon Swirl Pound Cake	Low	10-inch tube pan, glass plate	
91	Classic Cheesecake	Low	9-inch round glass dish	
92	Classic Cranberry Tea Cake	Low	12-cup bundt pan, glass plate	
93	Green Onion Biscuits	Low	Pizza pan	
94	Herb Biscuits	2 levels	High	2 pizza pans
95	No Knead Cheddar Dill Bread	Low	8-inch round cake pan	
96	Nut Cake with Mocha Cream	2 levels	High	2 (8-inch) round cake pans
97	Quick Sticky Rolls	1 level	Low	8-inch round cake pan
98	Very Berry Bundt Cake	Low	10-cup bundt pan, glass plate	
99	Yummy Blueberry Muffins	2 levels	High	2 (6-cup) muffin pans
100	Zucchini Muffins	2 levels	High	2 (6-cup) muffin pans

* This food choice requires a preheated oven. Be sure to wait until the preheat is over before putting the food in the oven.





MICROWAVE OPTIONS

There are 17 microwave settings, including **Popcorn**, **Reheat**, **Cook** and **Defrost**.

POPCORN

The popcorn setting automatically provides the correct cooking time for most brands of microwave popcorn. See the chart below.

- Suppose you want to pop a 3.5 ounce bag of regular popcorn.

PROCEDURE	
1. Touch Popcorn once.	
2. Select desired type of popcorn by touching the UP or DOWN arrows.	 or 
3. Touch START .	

Popcorn can be programmed with AUTOMATIC COOKING TIME ADJUSTMENT. See page 33.

Use a NordicWare® two-sided bacon/meat grill (grill side) made from heavy weight thermoset polyester when popping bagged microwave popcorn.





POPCORN CHART

AMOUNT	PROCEDURE
1 bag	Try several brands to decide which is most acceptable for your taste. Unfold bag and place in oven according to directions.
3.5 oz bag (Regular)	Touch Popcorn once and UP or DOWN arrows until REGULAR 3.5 OZ is displayed.
2.85 - 3.5 oz bag (Regular Light)	Touch Popcorn once and UP or DOWN arrows until REGULAR LIGHT 2.85 - 3.5 OZ is displayed.
1.5 - 1.75 oz (Snack)	Touch Popcorn once and UP or DOWN arrows until SNACK 1.5 - 1.75 OZ is displayed.

REHEAT / COOK

Reheat and **Cook** automatically compute the correct warming or cooking time and microwave power level for foods shown in the charts on page 30-31.

- Suppose you want to heat 2 cups of soup.

PROCEDURE	
1. Touch Reheat once.	
2. Select desired food by touching the UP or DOWN arrows.	 or 
3. Touch desired number to select quantity. (Ex: Touch number 2 for 2 cups)	
4. Touch START .	

NOTE:

1. To reheat or cook other foods above or below the quantity allowed on the Reheat Chart or Cook Chart, cook manually.
2. You can adjust cooking result as you like. Refer to AUTOMATIC COOKING TIME ADJUSTMENT on page 33.

30 Automatic Cooking

REHEAT CHART

FOOD	AMOUNT	PROCEDURE
1. Beverage	.5 - 2 cups	This setting is good for restoring cooled beverage to a better drinking temperature. Stir after heating.
2. Casserole	1 - 4 cups	Use to reheat refrigerated canned or homemade pasta with sauce or other cooked casserole. For room temperature pasta or casserole, use Less option. For pasta without sauce double the quantity per setting. For example, measure 2 cups of cooked noodles and program for 1 cup. Cover with lid or plastic wrap. After cooking, stir and let stand, covered, 2 to 3 minutes.
3. Dinner Plate	1 plate (regular)	Use to reheat precooked foods from the refrigerator. Place meaty portions and bulky vegetables to outside of plate. Cut large items like baked potatoes in smaller pieces. Flatten foods such as mashed potatoes and other dense foods. Cover with wax paper or plastic wrap. ONE PLATE ONLY. After cooking, check that food is very hot throughout and that the bottom center of the plate is very hot. If not, continue heating using time and power level. Allow to stand, covered, 1 to 2 minutes. A regular amount of food: approximately 4 oz. sliced meat or poultry, 1/2 cup potato or rice and 1/2 cup of vegetables or equivalent.
4. Fresh Rolls/Muffins	1 - 6 pcs.	Use to warm rolls, muffins, biscuits, bagels etc. Large item should be considered as 2 regular size. Cover each roll/muffin with paper towel. For refrigerated rolls or muffins, it may be necessary to double the entered amount to ensure the proper serving temperature. For example, enter quantity of 2 for 1 refrigerated muffin.
5. Soup	1 - 4 cups	Place in bowl or casserole. Cover with lid or plastic wrap. At end, stir, re-cover and let stand 1 to 3 minutes.

COOK CHART

FOOD	AMOUNT	PROCEDURE
1. Baked Potatoes	1 - 4 med.	Pierce with fork in several places. Place on paper towel on turntable. After cooking, remove from oven and let stand wrapped in foil for 5 to 10 minutes.
2. Fresh Vegetables	1 - 4 cups	For beans, carrots, corn and peas, add 1 tablespoon of water per cup. Cover with lid. For broccoli, Brussel sprouts, cabbage and cauliflower, cook immediately after washing with no additional water. Cover with plastic wrap. If you like tender crisp vegetables, double measured quantity per setting. For example, use 2 cups cauliflower and program for 1 cup. After cooking, remove from oven, stir, cover and let stand 3 to 5 minutes before serving.







COOK CHART (Cont.)

FOOD	AMOUNT	PROCEDURE
3. Frozen Entrees	6 - 17 oz	Use for frozen, convenience foods. It will give satisfactory results for most brands. You may wish to try several and choose your favorite. Remove package from outer wrapping and follow package directions for covering. After cooking, let stand covered for 1 to 3 minutes.
4. Frozen Vegetables	1 - 4 cups	Add no water. Cover with lid or plastic wrap. After cooking, stir and let stand, covered, for 3 minutes.
5. Ground Meat	.3 - 1.5 lb	Use this setting to cook ground beef or turkey as patties or in a casserole to be added to other ingredients. Place patties on a microwave-safe rack and cover with wax paper. Place ground meat in a casserole and cover with wax paper or plastic wrap. When oven stops, turn patties over or stir meat in casserole to break up large pieces. Re-cover and touch START . After cooking, let stand, covered for 2 to 3 minutes.

DEFROST

Defrost automatically defrost ground meat, steaks, chops, fish and poultry.

- Suppose you want to defrost a 2.0 lb steak.

PROCEDURE	
1. Touch Defrost .	
2. Select desired food by touching the UP or DOWN arrows.	 or 
3. Enter weight by touching the number pads 2 and 0 for 2.0 lb steak.	 
4. Touch START .	
The oven will stop so that the food can be checked.	
5. After the 1st stage, open the door. Turn steak over and shield any warm portions. Close the door. Touch START .	

- | | |
|---|---|
| 6. After the 2nd stage, open the door. Shield any warm portions. Close the door. Touch START . |  |
|---|---|

- | |
|--|
| 7. After defrost cycle ends, cover and let stand as indicated in chart below |
|--|

NOTE:

1. If you attempt to enter more or less than the allowed amount, **ERROR** will appear in the display.
2. Defrost can be programmed with AUTOMATIC COOKING TIME ADJUSTMENT. See page 33.
3. To defrost other foods or foods above or below the weights allowed on DEFROST CHART below, use time and 30% power. See Manual Defrost on page 32.

32 Automatic Cooking

DEFROST CHART

FOOD	AMOUNT	PROCEDURE
1. Bone-in Poultry	.5 - 3.0 lb	Arrange pieces with meatiest portions toward outside of glass dish or microwave safe rack. After each stage, if there are warm or thawed portions, rearrange or remove. Let stand, covered, for 10 to 20 minutes.
2. Boneless Poultry	.5 - 2.0 lb	Use boneless breast of chicken or turkey. After each stage, if there are warm or thawed portions, rearrange or remove. Let stand, covered, for 5 to 10 minutes.
3. Ground Meat	.5 - 2.0 lb	Remove any thawed pieces after each stage. Let stand, covered, 5 to 10 minutes.
4. Steaks/Chops	.5 - 3.0 lb	After each stage of defrost cycle, rearrange and if there are warm or thawed portions, shield with small flat pieces of aluminum foil. Remove any meat or fish that is nearly defrosted. Let stand, covered, 10 to 20 minutes.

NOTE: Check foods when oven signals. After final stage, small sections may still be icy. Let stand to continue thawing. Do not defrost until all ice crystals are thawed.

Shielding prevents cooking from occurring before the center of the food is defrosted. Use small smooth strips of aluminum foil to cover edges and thinner sections of the food.

MANUAL DEFROST

If the food that you wish to defrost is not listed on the DEFROST CHART or is above or below the limits in the "Amount" column on the DEFROST CHART, you need to defrost manually.

You can defrost any frozen food, either raw or previously cooked, by using 30% Power Level. See page 18. Estimate defrosting time and touch **POWER LEVEL** 8 times for 30% when you select the power level.

For either raw or previously cooked frozen food the rule of thumb is approximately 4 minutes per

pound. For example, defrost 4 minutes for 1 pound of frozen spaghetti sauce.

Always stop the oven periodically to remove or separate the portions that are defrosted. If food is not defrosted at the end of the estimated defrosting time, program the oven in 1 minute increments at 30% until totally defrosted.

When using plastic containers from the freezer, defrost only long enough to remove from the plastic in order to place in a microwave-safe dish.

DEMONSTRATION MODE

To demonstrate, touch **Clock**, the number 0 and touch **START** and hold for 3 seconds. **DEMO ON** will appear in the display. Cooking operations and specific special features can now be demonstrated with no power in the oven. For example, touch **Add a Minute** and the display will show **1.00** and count down quickly to **END**.

To cancel, touch **Clock**, then the number 0 and **STOP/CLEAR**. If easier, unplug the oven from the electrical outlet and replug.

AUTOMATIC COOKING TIME ADJUSTMENT

The cooking results may slightly vary depending on room temperature, initial food temperature and other factors. You can adjust cooking results as you like.

MORE / LESS TIME ADJUSTMENT BEFORE START

Should you discover that you like any of the Automatic Cooking Options slightly **more** done, touch the **Power Level once** before **START**.

The display will show **MORE**.

Should you discover that you like any of the Automatic Cooking Options slightly **less** done, touch the **Power Level twice** before **START**.

The display will show **LESS**.

EXTEND DURING COOKING

Add a Minute can be used to add up to 10 minutes during cooking. Touch **Add a Minute** repeatedly to extend cooking time in multiples of 1 minute. Carefully check the cooking doneness throughout the cooking time.







EXTEND AT THE COOKING END

When you open the door after the cooking, the display shows **IF YOU NEED EXTRA TIME, ENTER COOKING TIME** for 3 minutes. Enter the desired cooking time and touch **START**. You can add up to 9 min. 99 sec. Carefully check the cooking progress.

Popcorn cannot have extended cooking time. Even if there are still unpopped kernels, do not add time.

TIMER

- Suppose you want to time a 3-minute long distance phone call.











PROCEDURE	
1. Touch Timer and number 1.	 
2. Enter time.	  
3. Touch Timer again.	

MULTIPLE SEQUENCE COOKING

The oven can be programmed for up to 4 cooking sequences for microwave only and 2 cooking sequences for convection.

Sometimes cooking directions tell you to start on one power level and then change to a different power level. Your oven can do this automatically.

- Suppose you want to cook roast beef for 5 minutes at 100% and then continue to cook for 30 minutes at 50%.

PROCEDURE	
1. First touch Power Level once for 100% power. Then enter cooking time.	 x 1   
2. Touch Power Level 6 times for 50% power. Then enter second cooking time.	 x 6    
3. Touch START .	

NOTE:

- If **Power Level** is touched once, **HIGH POWER** will be displayed.
- If you wish to know power level, simply touch **Power Level**. As long as your finger is touching **Power Level**, the power level will be displayed.
- If multiple sequence cooking with convection, follow the **CONVECTION COOKING** procedure on page 17 two times before touching **START**.

34 Other Convenient Features

HELP

Help provides 4 features that make using your oven easy because specific instructions are provided in the Interactive Display.

1. CHILD LOCK

The Child Lock prevents unwanted oven operation such as by small children. The oven can be set so that the control panel is deactivated or locked. To set, touch **Help**, the number 1 and then touch **START**. Should a pad be touched, **CHILD LOCK ON** will appear in the display.

To cancel, touch **Help** and **STOP/CLEAR**.

2. AUDIBLE SIGNAL ELIMINATION













If you wish to have the oven operate with no audible signals, touch **Help**, the number 2 and then touch **STOP/CLEAR**.

To cancel and restore the audible signal, touch **Help**, the number 2 and then touch **START**.

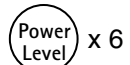
3. AUTO START

If you wish to program your oven to begin cooking automatically at a designated time of day, follow this procedure:

- Suppose you want to start cooking a stew for 20 minutes on 50% at 4:30. Before setting, check to make sure the clock is showing the correct time of day.

PROCEDURE	
1. Touch Help .	
2. Touch number 3.	
3. Enter the start time.	  
4. Touch Clock .	
5. Enter cooking program.	    
6. Touch START .	

NOTE:

1. Auto Start can be used for manual cooking if clock is set.
2. If the oven door is opened after programming Auto Start, it is necessary to touch **START** for Auto Start time to appear in the readout so that the oven will automatically begin programmed cooking at the chosen Auto Start time.
3. Be sure to choose foods that can be left in the oven safely until the Auto Start time. Acorn or butternut squash are often a good choice.
4. If you wish to know the time of day, simply touch **Clock**. As long as your finger is touching **Clock**, the time of day will be displayed.



4. REFRESH CYCLE

The oven has a special catalyst which assists with smoke and odor removal.

Use the Refresh Cycle to:

- Condition the heater before using the oven the first time.
- Remove any objectionable odor.
- Keep the catalyst in optimum condition.

Follow the procedure below. The oven temperature will be maintained at 450°F when the refresh cycle operates.

PROCEDURE	
1. Touch Help .	
2. Touch number 4.	
3. Touch START .	

NOTE:

1. Remove the turntable from the oven before the Refresh Cycle. No food should be in the oven.
2. The Refresh Cycle is 30 minutes.
3. During the Refresh Cycle some smoke and odor may occur. Open a window or use the ventilation fan in the room.

CAUTION:

The oven door, outer cabinet and oven cavity may be hot.

ADD A MINUTE

Add a Minute allows you to cook for a minute at 100% by simply touching **Add a Minute**. You can also extend cooking time in multiples of 1 minute by repeatedly touching **Add a Minute** during manual and automatic cooking.

Add a Minute can be used to add up to 99 minutes during manual cooking and 10 minutes during automatic cooking.

- Suppose you want to heat a cup of soup for one minute.

PROCEDURE	
Touch Add a Minute .	

NOTE:

To use Add a Minute, touch pad within 3 minutes after cooking, closing the door, touching the STOP/CLEAR pad or during cooking.

HELP (INTERACTIVE DISPLAY)

When **Help** is flashing, touch the pad to read valuable information.

Help is flashing when you are setting **Help** feature (Child Lock, Audible Signal Elimination, Auto Start and Refresh Cycle).

36 Cleaning and Care

Disconnect the power cord before cleaning or leave the door open to inactivate the oven during cleaning.

EXTERIOR

The outside surface is precoated metal and plastic. Clean the outside with mild soap and water; rinse and dry with a soft cloth. Do not use any type of household or abrasive cleaner.

DOOR

Wipe the window on both sides with a damp cloth to remove any spills or spatters. Metal parts will be easier to maintain if wiped frequently with a damp cloth. Avoid the use of spray and other harsh cleaners as they may stain, streak or dull the door surface.

STAINLESS STEEL TRIM

The exterior should be wiped often with a damp cloth and polished with a soft dry cloth to maintain its beauty. There are also a variety of products designed especially for cleaning and shining the stainless exterior of the oven. We recommend that the cleaner be applied to a soft cloth and then carefully used on the stainless exterior rather than sprayed directly on to it. Follow package directions carefully.

TOUCH CONTROL PANEL

Wipe the panel with a cloth dampened slightly with water only. Dry with a soft cloth. Do not scrub or use any sort of chemical cleaners. Close door and touch **STOP/CLEAR**.

INTERIOR - after microwave cooking

Cleaning is easy because no heat is generated to the interior surfaces; therefore, there is no baking and setting of spills or spattering. To clean the interior surfaces, wipe with a soft cloth and warm water. **DO NOT USE ABRASIVE OR HARSH CLEANERS OR SCOURING PADS.** For heavier soil, use mild soap; rinse thoroughly with hot water. Do not use any chemical oven cleaners.

You may remove any lingering interior odor by using the Refresh Cycle on page 34.

INTERIOR - after manual/automatic speed or convection cooking.

Spatters may occur because of moisture and grease. Wash immediately after use with hot, soapy water. Rinse and polish dry. Harder to remove spatters may occur if oven is not thoroughly cleaned or if there is long time/high temperature cooking. Do not use any chemical oven cleaners.

After cleaning the interior thoroughly, residual grease may be removed from the interior ducts and heaters by simply operating the oven with Refresh Cycle on page 34. Ventilate the room if necessary.

WAVEGUIDE COVER

The waveguide cover is made from mica so requires special care. Keep the waveguide cover clean to assure good oven performance. Carefully wipe with a damp cloth any food spatters from the surface of the cover immediately after they occur. Built-up splashes may overheat and cause smoke or possibly catch fire. Do not remove the waveguide cover.

ACCESSORIES

The turntable, turntable support, racks and splash guard can be removed for easy cleaning. Wash them in mild, sudsy water; for stubborn stains use a mild cleanser and a non-abrasive scouring sponge. They are also dishwasher-proof. Use upper rack of dishwasher for turntable support.

Foods with high acidity, such as tomatoes or lemons, may cause the porcelain enamel turntable and splash guard to discolor. Do not cook highly acidic foods directly on the turntable; if spills occur, wipe up immediately.

SPECIAL NOTE FOR TURNTABLE SUPPORT

After cooking, always clean the turntable support, especially around the rollers. These must be free from food splashes and grease. Built-up splashes or grease may overheat and cause arcing, begin to smoke or catch fire.

Service Call Check 37

Please check the following before calling for service:

1. Place one cup of water in a glass measuring cup in the oven and close the door securely.

Operate the oven for one minute at HIGH 100%.

- | | | |
|--|-----------|----------|
| A Does the oven light come on? | YES _____ | NO _____ |
| B Does the cooling fan work?
(Put your hand over the rear ventilating openings.) | YES _____ | NO _____ |
| C Does the turntable rotate?
(It is normal for the turntable to turn in either direction.) | YES _____ | NO _____ |
| D Is the water in the oven warm? | YES _____ | NO _____ |

2. Remove water from the oven and operate the oven for 5 minutes at CONVECTION 450°F.

- | | | |
|---|-----------|----------|
| A Do CONVEC and COOK indicators light? | YES _____ | NO _____ |
| B After the oven shuts off, is inside of the oven hot? | YES _____ | NO _____ |

If "NO" is the answer to any of the above questions, please check electrical outlet, fuse and/or circuit breaker. If they are functioning properly, CONTACT YOUR NEAREST ELECTROLUX AUTHORIZED SERVICER.

A microwave oven should never be serviced by a "do-it-yourself" repair person.

NOTE:

1. If the time appearing in the display is counting down very rapidly, check Demonstration Mode on page 33 and cancel.
 2. After cooking, the cooling fan may switch on to cool the oven cavity. When the cooling fan is on, the display may show "NOW COOLING" and you will hear the sound of the cooling fan.
 3. Your oven has a voltage check function. If the voltage rises above 7% or falls below 7% of the needed 240 volts, the cooking results would not be acceptable; therefore the oven will stop, display an error message and interrupt the cooking program. Press **STOP/CLEAR** and complete the cooking manually. It is imperative that the power to the oven be checked to ensure that a 240 volt circuit is serving the oven.
-

38 Specification

AC Line Voltage		Single phase 240V, 60 Hz, AC only
AC Power Required	Microwave Convection Speed Cooking	1700 W 7.9 amps 3100 W 14.2 amps 3200 W 12.8 amps
Output Power	Microwave	1000 W*
	Top Heater	1500 W
	Side Heater	1200 W
Frequency		2450 MHz
Outside Dimensions		30" (W) x 22-7/8" (H) x 25-11/16" (D)
Cavity Dimensions**		16-1/8"(W) x 8-3/8"(H) x 13-5/8"(D)
Oven Capacity**		1.1 Cu. Ft.
Cooking Uniformity		Turntable
Weight		105 LB (unit only)

* The International Electrotechnical Commission's standardized method for measuring output wattage. This test method is widely recognized.

** Internal capacity is calculated by measuring maximum width, depth and height. Actual capacity for holding food is less.

In compliance with standards set by:

FCC - Federal Communications Commission Authorized.

DHHS - Complies with Department of Health and Human Services (DHHS) rule, CFR, Title 21, Chapter I, Subchapter J.



- This symbol on the nameplate means the product is listed by Underwriters Laboratories, Inc.

HIGH SPEED OVEN WARRANTY

Your Wall oven is protected by this warranty

	WARRANTY PERIOD	THROUGH OUR AUTHORIZED SERVICERS, WE WILL:	THE CONSUMER WILL BE RESPONSIBLE FOR:
FULL ONE YEAR WARRANTY	One year from original purchase date.	Pay all costs for repairing or replacing any parts of this appliance which prove to be defective in materials or workmanship.	Costs of service calls that are listed under NORMAL RESPONSIBILITIES OF THE CONSUMER.*
UNLIMITED WARRANTY (Applicable to the State of Alaska)	Time periods listed above.	All of the provisions of the full warranties above and the exclusions listed below apply.	Costs of the technician's travel to the home and any costs for pick up and delivery of the appliance required because of service.

In the U.S.A., your appliance is warranted by Electrolux Home Products North America, a division of White Consolidated Industries, Inc. We authorize no person to change or add to any of our obligations under this warranty. Our obligations for service and parts under this warranty must be performed by us or an authorized Electrolux Home Products North America servicer. In Canada, your appliance is warranted by Electrolux Canada Corp.

*NORMAL RESPONSIBILITIES OF THE CONSUMER

This warranty applies only to products in ordinary household use, and the consumer is responsible for the items listed below:

1. Proper use of the appliance in accordance with instructions provided with the product.
2. Proper installation by an authorized servicer in accordance with instructions provided with the appliance and in accordance with all local plumbing, electrical and/or gas codes.
3. Proper connection to a grounded power supply of sufficient voltage, replacement of blown fuses, repair of loose connections or defects in house wiring.
4. Expenses for making the appliance accessible for servicing, such as removal of trim, cupboards, shelves, etc., which are not a part of the appliance when it was shipped from the factory.
5. Damages to finish after installation.
6. Replacement of light bulbs and/or fluorescent tubes (on models with these features).

EXCLUSIONS

This warranty does not cover the following:

1. CONSEQUENTIAL OR INCIDENTAL DAMAGES SUCH AS PROPERTY DAMAGE AND INCIDENTAL EXPENSES RESULTING FROM ANY BREACH OF THIS WRITTEN OR ANY IMPLIED WARRANTY.
NOTE: Some states do not allow the exclusion or limitation of incidental or consequential damages, so this limitation or exclusion may not apply to you.
2. Service calls which do not involve malfunction or defects in workmanship or material, or for appliances not in ordinary household use. The consumer shall pay for such service calls.
3. Damages caused by services performed by servicers other than Electrolux Home Products North America or its authorized servicers; use of parts other than genuine Electrolux Home Products parts; obtained from persons other than such servicers; or external causes such as abuse, misuse, inadequate power supply or acts of God.
4. Products with original serial numbers that have been removed or altered and cannot be readily determined.

IF YOU NEED SERVICE

Keep your bill of sale, delivery slip, or some other appropriate payment record. The date on the bill establishes the warranty period should service be required. If service is performed, it is in your best interest to obtain and keep all receipts. This written warranty gives you specific legal rights. You may also have other rights that vary from state to state. Service under this warranty must be obtained by contacting Electrolux Home Products:

USA
1-800-944-9044
 Electrolux Home Products
 North America
 P.O. Box 212378
 Augusta, GA 30917

Canada
1-866-294-9911
 Electrolux Home Products
 North America
 802, boul. L'ange-Gardien
 L'Assomption, Québec
 J5W 1T6

This warranty only applies in the 50 states of the U.S.A., Puerto Rico, and Canada. Product features or specifications as described or illustrated are subject to change without notice. All warranties are made by Electrolux Home Products North America, a division of White Consolidated Industries, Inc. In Canada, your appliance is warranted by Electrolux Canada Corp.

For toll-free telephone support in the U.S. and Canada.

1-877-4ELECTROLUX (1-877-435-3287)

For online support and internet product information:

www.electrolux.com

©2003 Electrolux Home Products, Inc.

Post Office Box 212378, Augusta

Georgia 30917, USA

All right reserved. Printed in the USA