

Electrolux

CONTENTS

- 3 Important Safety Instructions
- 8 Cooking Recommendations
- 11 Before Setting Oven Controls
- 13 Setting Oven Controls
- 36 Care and Cleaning
- 41 Before You Call
- 44 Warranty

PLEASE READ AND SAVE THIS GUIDE

Thank you for purchasing an Electrolux appliance. You've chosen a product that brings with it decades of professional experience and innovation. Ingenious and stylish, it has been designed with you in mind. So whenever you use it, you can be safe in the knowledge that you'll get great results every time.

This Use & Care Guide is part of our commitment to customer satisfaction and product quality throughout the service life of your new appliance. We view your purchase as the beginning of a relationship. To ensure our ability to continue serving you, please use this page to record important product information.

CUSTOMER CARE AND SERVICE

Keep a Record for Quick Reference

Purchase Date

Electrolux model number

Electrolux serial number

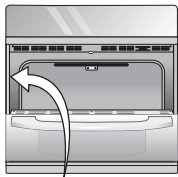

When contacting Service, ensure that you have the following data available. The information can be found on the rating plate. Serial plate location: open lower oven drawer (some models) or warmer drawer (some models). We recommend the use of original spare parts. Registering your product with Electrolux enhances our ability to serve you. You can register online at www.electroluxappliances.com or by dropping your Product Registration Card in the mail. For toll-free telephone support in the U.S. and Canada:

1-877-4ELECTROLUX (1-877-435-3287).

VISIT OUR WEBSITE FOR ACCESSORIES, CONSUMABLES, AND MORE!

The Electrolux Webshop



In the Electrolux webshop you'll find everything you need to keep all your Electrolux appliances looking spotless and working perfectly. Electrolux offers a wide range of accessories designed and built to the high quality standards you would expect from specialist cookware to cutlery baskets, from bottle holders to delicate laundry bags.

Visit the webshop at: www.electrolux.com/shop

On the Electrolux Website

Want to learn more about your product or discover additional Electrolux appliances? If so, then check out the link below for product overviews, a list of features, photo galleries, product manuals (complete owner's guide, installation instructions, wiring diagrams, product spec sheets), specifications, reviews, related accessories, and video guides.

For online support and Internet production information, visit <http://www.electroluxappliances.com>

www.electrolux.com

1-877-435-3287

Important Safety Instructions

Read all instructions before using this appliance.

This manual contains important safety symbols and instructions. Please pay attention to these symbols and follow all instructions given.

Do not attempt to install or operate your appliance until you have read the safety precautions in this manual. Safety items throughout this manual are labeled with a **WARNING** or **CAUTION** statement based on the risk type.

Warnings and important instructions appearing in this guide are not meant to cover all possible conditions and situations that may occur. Common sense, caution, and care must be exercised with installing, maintaining, or operating your appliance.

DEFINITIONS



This is the safety alert symbol. It is used to alert you to potential personal injury hazards. Obey all safety messages that follow this symbol to avoid possible injury or death

⚠ WARNING

Indicates a potentially hazardous situation which, if not avoided, may result in death or serious injury.

⚠ CAUTION

Indicates a potentially hazardous situation which, if not avoided, may result in minor or moderate injury.

IMPORTANT! Indicates installation, operation, maintenance, or valuable information that is not hazard related.



General Information, Important, Hints and Tips

Indicates useful information to avoid malfunctions and is also used for hints and tips how the appliance works in the best way. Information icon followed by supporting text.

⚠ WARNING Tip Over Hazard



- A child or adult can tip the oven and be killed.
- Install the anti-tip device to oven and/or structure per installation instructions.

- Ensure the anti-tip device is re-engaged when the oven is moved.
- Do not operate the oven without the anti-tip device in place and engaged.
- Failure to follow these instructions can result in death or serious burns to children and adults.

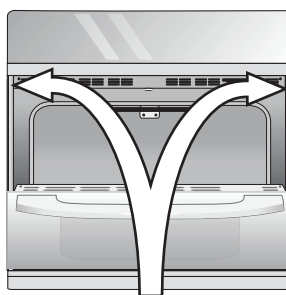

Anti-tip mounting holes

Refer to the installation instructions supplied with your appliance for proper installation.

Check for proper installation with a visual check that the anti-tip screws are present. Test the installation with light downward pressure on the open oven door. The oven should not tip forward.

Save these instructions for future reference.

Important Safety Instructions

IMPORTANT INSTRUCTIONS FOR UNPACKING AND INSTALLATION

IMPORTANT - Read and follow the below instructions and precautions for unpacking, installing, and servicing your appliance:

Remove all tape and packaging before using the appliance. Destroy the carton and plastic bags after unpacking the appliance. Never allow children to play with packaging material. Do not remove the wiring label and other literature attached to the appliance. Do not remove model/serial number plate.

Cold temperatures can damage the electronic control. When using this appliance for the first time, or when the appliance has not been used for an extended period of time, be sure the appliance has been in temperatures above 32°F (0°C) for at least 3 hours before turning on the power to the appliance.

Never modify or alter the construction of the appliance by removing the leveling legs, panels, wire covers, anti-tip brackets/screws, or any other part of the appliance.

Be sure to have an appropriate foam-type fire extinguisher available, visible, and easily accessible located near the appliance.

GROUNDING INSTRUCTIONS

⚠ WARNING

Avoid fire hazard or electrical shock. Failure to follow this warning may cause serious injury, fire, or death.

⚠ WARNING

Avoid fire hazard or electrical shock. Do not use an adapter plug, use an extension cord, or remove grounding prong from the power cord. Failure to follow this warning may cause serious injury, fire, or death.

Proper Installation—Be sure your appliance is properly installed and grounded by a qualified technician. In the United States, install in accordance with the National Fuel Gas Code ANSI Z223.1/NPFA No. 54, latest edition and National Electrical Code NFPA No. 70 latest edition, and local electrical code requirements. In Canada, install in accordance with CAN/CGA B149.1 and CAN/CGA B149.2 and CSA Standard C22.1, Canadian Electrical code, Part 1-latest editions and local electrical code requirements. Install only per installation instructions provided in the literature package for this appliance.

For personal safety, this appliance must be properly grounded. For maximum safety, the power cord must be securely connected to an electrical outlet or junction box that is the correct voltage, is correctly polarized and properly grounded, and protected by a circuit breaker in accordance with local codes and ordinances.

It is the personal responsibility of the consumer to have the appropriate outlet or junction box with the correct, properly grounded wall receptacle installed by a qualified electrician. It is the responsibility and obligation of the consumer to contact a qualified installer to assure that the electrical installation is adequate and is in conformance with all local codes and ordinances.

See the installation instructions packaged with this appliance for complete installation and grounding instructions.

Save these instructions for future reference.

Important Safety Instructions

IMPORTANT INSTRUCTIONS FOR USING THE APPLIANCE

⚠ WARNING

Storage In or On Appliance—Flammable materials should not be stored in an oven or microwave, near surface burners or elements, or in the storage or warmer drawer (if equipped). This includes paper, plastic, and cloth items, such as cookbooks, plastic ware, and towels, as well as flammable liquids. Do not store explosives, such as aerosol cans, on or near the appliance.

⚠ WARNING

Do not leave children alone - Children should not be left alone or unattended in the area where appliance is in use. They should never be allowed to sit or stand on any part of the appliance, including the storage drawer, lower broiler drawer, warmer drawer, or lower double oven.

⚠ WARNING

Do not store items of interest to children in the cabinets above the appliance or on the backguards of ovens. Children climbing on or near the appliance to reach items could be seriously injured.

⚠ WARNING

Do not allow children to climb or play around the appliance. The weight of a child on an open oven door may cause the appliance to tip, resulting in serious burns or other injury. An open drawer when hot may cause burns.

⚠ WARNING

Stepping, leaning, or sitting on the door or drawers of this appliance can result in serious injuries and also cause damage to the appliance.

⚠ WARNING

Never cover any slots, holes, or passages in the oven bottom or cover an entire oven rack with any materials, such as aluminum foil or aftermarket oven liners. Aluminum foil and other liners may trap heat, causing a fire hazard.

⚠ WARNING

Do not use oven or warmer drawer (if equipped) for storage.

⚠ WARNING

Never use your appliance as a space heater to heat or warm the room. Doing so may result in carbon monoxide poisoning and overheating of the appliance.

⚠ CAUTION

When heating fat or grease, watch it closely. Grease may catch fire if it becomes too hot.

⚠ CAUTION

Do not use water or flour on grease fires. Smother fire or flame or use dry chemical or foam-type extinguisher. Cover the fire with a pan lid or use baking soda.

⚠ CAUTION

Use dry potholders. Moist or damp potholders on hot surfaces may result in burns from steam. Do not let potholders touch hot cooking areas. Do not use towels or other bulky cloths.

⚠ CAUTION

Do not heat unopened food containers - Build-up of pressure may cause container to burst and result in injury.

⚠ CAUTION

Wear proper apparel - Loose-fitting or hanging garments should never be worn while using the appliance. Do not let clothing or other flammable materials contact hot surfaces.

⚠ CAUTION

Do not touch surface burners or elements, areas near these burners or elements, interior surfaces of the oven, or the warmer drawer (if equipped). Surface burners and elements may be hot even though they appear cool. Areas near surface burners and elements may become hot enough to cause burns. During and after use, do not touch, or let clothing or other flammable materials touch these areas until they are cool. These areas may include the cooktop, surfaces facing the cooktop, oven vent areas, oven door, and oven window.

Save these instructions for future reference.

Important Safety Instructions

⚠ CAUTION

Do not attempt to operate the appliance during a power failure. If the power fails, always turn off the appliance. If the appliance is not turned off and the power resumes, electric surface elements may resume operation when power is restored. Once the power resumes, reset the clock and the oven function.

IMPORTANT INSTRUCTIONS FOR USING YOUR OVEN

Protective liners—Do not use aluminum foil, after-market oven liners, or any other materials or devices to line oven bottom, oven racks, or any other part of the appliance. Only use aluminum as recommended for baking, such as lining cookware or as a cover placed on food. Any other use of protective liners or aluminum foil may result in a risk of electric shock or fire or a short circuit.

Use care when opening oven door, lower oven door, or warmer drawer (some models). Stand to the side of the appliance when opening the door of a hot oven. Let hot air or steam escape before you remove or replace food in the oven.

Keep oven vent ducts unobstructed. Touching surfaces in this area when the oven is on may cause severe burns. Do not place plastic or heat-sensitive items on or near the oven vent. These items can melt or ignite.

Placement of oven racks - Always place oven racks in desired location while oven is cool. If rack must be moved while oven is hot, do not let potholder contact hot burner or element in oven. Use potholders and grasp the rack with both hands to reposition. Remove all cookware and utensils before moving the rack.

Do not use a broiler pan without its insert. Broiler pans and inserts allow dripping fat to drain away from the high heat of the broiler. Do not cover the broiler insert with aluminum foil; exposed fat and grease could ignite.

Do not cook food on the oven bottom. Always cook in proper cookware and always use the oven racks.

IMPORTANT INSTRUCTIONS FOR CLEANING YOUR APPLIANCE

⚠ CAUTION

Before manually cleaning any part of the appliance, be sure all controls are turned off and the appliance is cool. Cleaning a hot appliance can cause burns.

Clean the appliance regularly to keep all parts free of grease that could catch fire. Do not allow grease to accumulate. Greasy deposits in the fan could catch fire.

Always follow the manufacturer's recommended directions for use of kitchen cleaners and aerosols. Be aware that excess residue from cleaners and aerosols may ignite causing damage and injury.

Clean ventilating hoods frequently - Grease should not be allowed to accumulate on hood or filter. Follow the manufacturer's instructions for cleaning vent hoods.

IMPORTANT INSTRUCTIONS FOR SELF CLEANING OVENS

Do not clean the oven door gasket. The door gasket is essential for a good seal. Care should be taken not to rub, damage, or move the gasket.

Do not use oven cleaners. No commercial oven cleaner or oven liner protective coating of any kind should be used in or around any part of the appliance.

Use the self clean cycle to clean only the parts listed in this manual.

Before using self clean, remove the broiler pan, any food, utensils, and cookware from the oven, storage drawer or warming drawer (if equipped). Remove oven racks unless otherwise instructed.

Some birds are extremely sensitive to the fumes given off during the self clean cycle of any oven. Move birds to another well-ventilated room.

Save these instructions for future reference.

Important Safety Instructions

IMPORTANT INSTRUCTIONS FOR SERVICE AND MAINTENANCE

Do not repair or replace any part of the appliance unless specifically recommended in the manuals. All other servicing should be done only by a qualified technician. This reduces the risk of personal injury and damage to the appliance.

Always contact your dealer, distributor, service agent, or manufacturer about problems or conditions you do not understand.

Ask your dealer to recommend a qualified technician and an authorized repair service. Know how to disconnect the power to the appliance at the circuit breaker or fuse box in case of an emergency.

Remove the oven door from any unused oven if it is to be stored or discarded.

Do not touch a hot oven light bulb with a damp cloth. Doing so could cause the bulb to break. Handle halogen lights (if equipped) with paper towels or soft gloves. Disconnect the appliance or shut off the power to the appliance before removing and replacing the bulb.



Important Safety Notice - The California Safe Drinking Water and Toxic Enforcement Act requires the governor of California to publish a list of substances known to cause cancer, birth defects, or other reproductive harms, and requires businesses to warn customers of potential exposures to such substances.

Save these instructions for future reference.

COOKING RECOMMENDATIONS

Bakeware

The material of bakeware affects how evenly and quickly it transfers heat from the pan to the food.

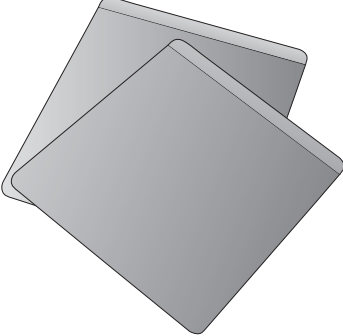
Material	Attributes	Recommendation
<p>Shiny metal bakeware</p> 	<p>Shiny, aluminum, and non-coated bakeware is the best for even heating. It is suitable for all baked goods.</p>	<p>Recommended cooking temperatures and times are based on shiny metal bakeware.</p>
<p>Dark metal bakeware</p> 	<p>Dark bakeware cooks hotter than shiny bakeware.</p>	<p>Reduce the cooking temperature by 25° F (13-14° C) when using dark bakeware.</p>
<p>Glass bakeware</p> 	<p>Glass bakeware cooks hotter than shiny bakeware.</p> <p>Glass is convenient, as the same piece of bakeware can be used for cooking, serving, and storing food.</p>	<p>Reduce the cooking temperature by 25° F (13-14° C) when using glass bakeware.</p>
<p>Insulated bakeware</p> 	<p>Insulated bakeware cooks cooler than shiny bakeware.</p> <p>Insulated bakeware is designed for baking in gas ovens.</p>	<p>Increase the cooking temperature by 25° F (13-14° C) when using insulated bakeware.</p>

Cooking Conditions

Conditions in your kitchen can affect the performance of your appliance when cooking food.

Condition	Attributes	Recommendation
Aging cookware	As pans age and become discolored, cooking times may need to be reduced slightly.	If food is too dark or overcooked, use the minimum cook time in the recipe or packaging. If food is too light or under cooked, use the middle to maximum cook time in the recipe or packaging.
High altitude	Air is drier and air pressure is lower. Water boils at a lower temperature, and liquids evaporate faster. Foods may take longer to bake. Doughs may rise faster.	Adjust cooking temperature, cooking time, or recipes as needed. Increase amount of liquid in baking recipes. Increase cook time in oven. Cover dishes to reduce evaporation. Increase bake time or oven temperature. Reduce amount of baking soda or baking powder in recipe. Reduce rising time or punch down dough and allow it to rise twice.

Cooking Results

Small adjustments may fix a problem with food not being as done as you like or more done than you like.

Result	Recommendation
Food too light	Use the middle to maximum cook time recommended on packaging or recipe.
Food too dark	Use the minimum cook time recommended on packaging or recipe.

Cooking Tips

Use these additional tips to get the best results from your appliance.

Cooking Tips	
Baking	
Rack placement	Follow the instructions in "Setting Oven Controls" on starting on page 13 . When using only one rack, place the rack so the food is in the center of the oven.
Preheat	Fully preheat the oven before baking items like cookies, cakes, biscuits and breads. Insert food immediately after the beep.
Checking food	Use the window and oven light when checking food. Opening the door may reduce baking performance.
Bake or Convection Bake	Convection bake is the best function to use for baking on multiple racks. For best performance, see "Convection bake" on page 18 .
Food placement	Allow at least 2 inches (5 cm) of space between bakeware for proper air circulation.
Broiling / Roasting	
Broiling pan	For best results when broiling, use a broil pan with a broil pan insert designed to drain the fat from the food, help avoid spatter, and reduce smoking. The broiler pan will catch grease spills, and the insert helps prevent grease splatters. If a broiler pan and insert are not supplied with this appliance, they may be purchased from Frigidaire.com.

Cooking Tips

Convection Cooking

Convection attributes	<p>Convection cooking uses a fan to circulate hot air around the oven and food. It browns food more evenly and reduces hot spots in the oven.</p> <p>Convection saves time when using multiple racks or cooking several food items at once.</p>
Convection bake	<p>Reduce cooking temperature by 25° F (13-14° C) from the recipe unless the recipe is written for convection baking.</p> <p>Preheat the oven for best results.</p>
Convection roast	<p>Convection roast is best for meats and does not require preheating for most meats and poultry.</p> <p>Reducing the cooking temperature for convection roast is not recommended. Carefully follow your recipe's temperature and time recommendations, adjusting the cooking time if the recipe does not specify convection roasting time.</p> <p>Since convection roast cooks faster, cook time may be reduced by 25% to 40% depending on food type. You can reduce cook times by 25% from the recommended time of your recipe, and check the food at this time. If needed, continue cooking until the desired doneness is obtained.</p> <p>Use a meat probe if available with your appliance. Meat probes are also available from most grocery and home goods stores.</p> <p>Arrange oven racks so large cuts of meat and poultry are on the lowest rack of the oven.</p> <p>Do not cover foods when dry roasting - covering will prevent the meat from browning properly.</p> <p>When cooking meats, use the broiler pan and insert or a roasting rack. The broiler pan will catch grease spills and the insert helps prevent grease splatters. If you do not have one of these accessories, they may be purchased from www.electrolux.com.</p>

BEFORE SETTING OVEN CONTROLS

Oven Vents

The oven vent is located under the control panel. When the oven is on, warm air passes through this vent. This venting is necessary for proper air circulation in the oven and good baking results. Do not block oven vent. Steam or moisture may appear near the oven vent. This is normal.



Figure 1: Oven vent locations

IMPORTANT! Some models are equipped with a cooling fan that runs during the cooking process to cool internal electronic components. It is normal for this fan to continue to run for an extended period of time, even when the oven is off.

Oven Racks

CAUTION

Do not line the oven walls, racks, bottom, or any other part of the oven with aluminum foil. Doing so will alter heat distribution, produce poor baking results, and may cause permanent damage to the oven interior. During self clean temperatures, the oven will be hot enough to melt foil.

IMPORTANT! All racks and the ladder racks supports should be removed before a self clean. Racks left in during a self clean may discolor and become harder to operate. To remove the ladder rack support for a self clean cycle, reverse the order used when installing the ladder rack supports.

Types of Oven Racks

Flat Oven Rack

Flat oven racks (or the flat handle oven rack) may be used for most cooking needs and may be placed in most oven rack positions.

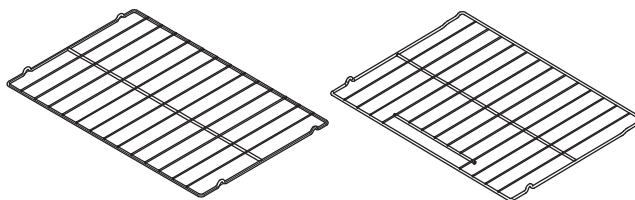

Figure 2: Flat oven rack and flat handle oven rack

CAUTION

Always use potholders or oven mitts when removing food or adjusting the oven racks. Wait until the oven is completely cooled if possible. Oven racks may be very hot and may cause burns.

CAUTION

Always remove/replace the oven racks before turning on the oven (when the oven is cool).

IMPORTANT! To prevent possible damage to the oven, do not attempt to close the oven door until all the oven racks are fully positioned back inside the oven cavity.



Clean oven racks according to the instructions provided in the Care & Cleaning section.

Arranging, Removing, and Replacing Flat or Offset Oven Racks

- To Arrange: Always arrange the oven racks when the oven is cool (prior to operating the oven).
- To Remove: Pull the oven rack straight forward until it reaches the stop position. Lift up front of oven rack slightly and slide out.
- To Replace: Place the oven rack on the rack guides on the oven walls. Tilt the front of the rack upward slightly and slide the oven rack back into place.

The Luxury-Glide™ rack has a locking mechanism that operates differently than flat racks. See instructions on next page for installing and removing glide rack.

Luxury Glide™ Oven Racks

The fully extendable Luxury-Glide™ rack makes food preparation easier. This oven rack has glide tracks that allow the rack to be pulled away from the oven without rubbing the sides of the oven wall.

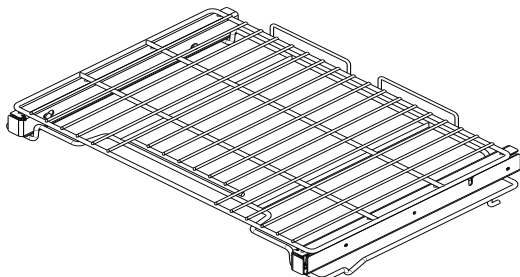

Figure 3: Luxury Glide™ rack

⚠ CAUTION

Always use pot holders or oven mitts when using the oven. When cooking, the oven interior and exterior, as well as the oven racks, will become very hot which can cause burns. Always remove/replace the oven racks before turning on the oven (when the oven is cool).

To install or replace the Glide Rack:

1. Grasp both upper and lower portions of the Glide Rack. (Figure 6).
2. Lift and hold the rack level between the oven cavity walls.
3. Tilt the front of the rack upward slightly and slide the rack completely into position. Some force may be necessary to make sure the oven rack has snapped into place.

To remove the oven Glide Rack:

1. Lift up on the release lever located across the lower front of the rack, as shown in (Figure 5).
2. While holding up the release lever (Figure 5) pull the Glide Rack out of the oven until the stop position is reached. Use two hands if necessary.
3. Using both hands, grasp the upper and lower portions of the Glide Rack (Figure 6) and lift up the front of the rack slightly and continue to pull the rack away from the oven.
4. Be sure to grasp both upper and lower rack portions together when removing or handling the Glide Rack. The rack portions move independently and are difficult to handle unless held together.

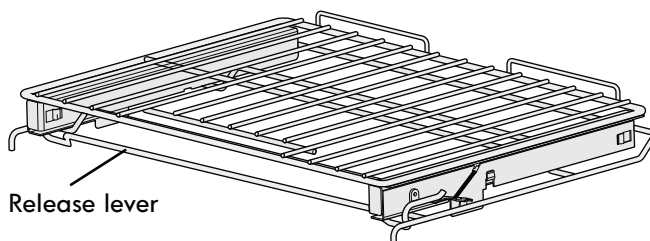

Figure 4: Extendable glide rack with release lever in locked position

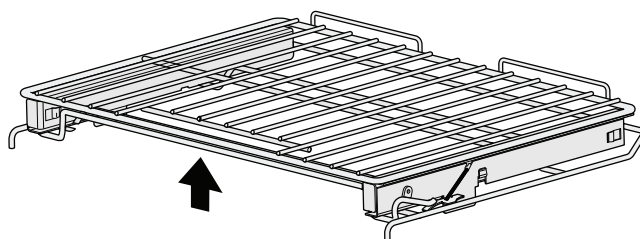

Figure 5: Extendable Glide Rack with release lever in unlocked position. To release pull up on release lever.

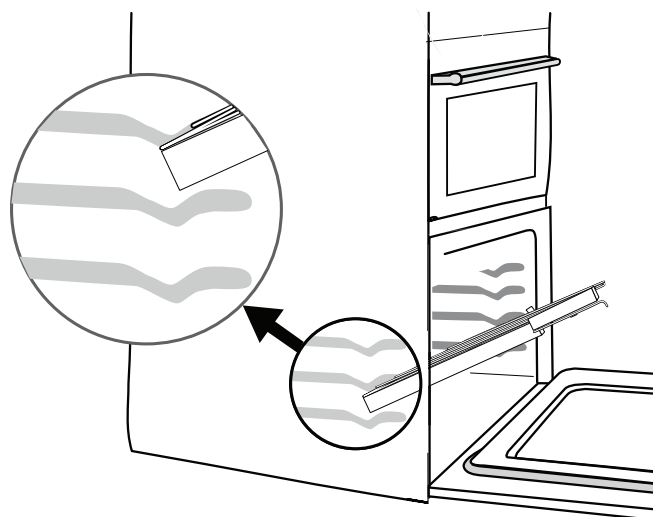
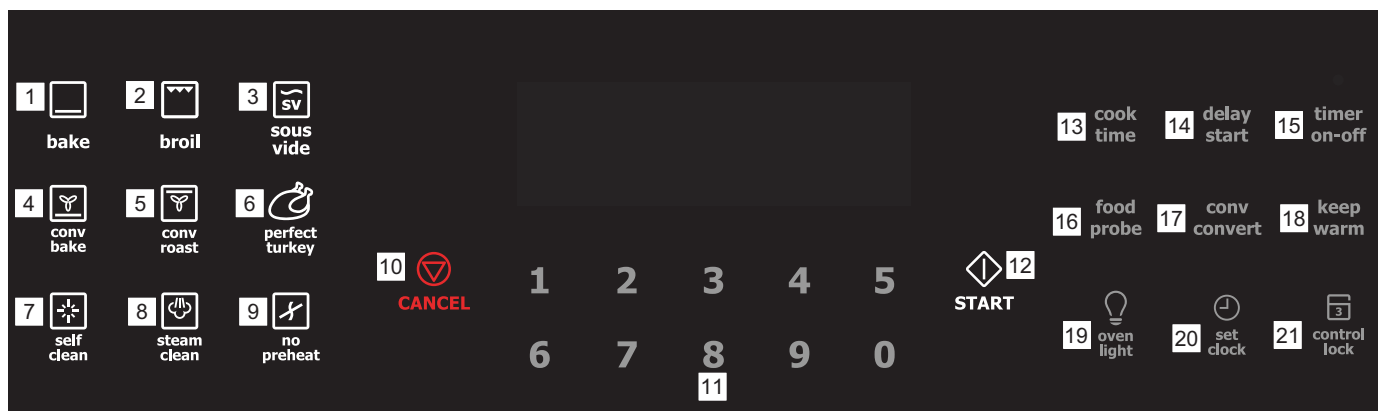

Figure 6: Removing and replacing the oven Glide Rack

SETTING OVEN CONTROLS



1. **Bake** - Use to enter normal baking temperatures for recipes that call for regular baking.
2. **Broil** - Selects normal broil function with a default temperature of 550°F (288°C) for direct heat cooking.
3. **Sous Vide** - Uses circulating hot air to slowly cook food in suitable sealed vacuum pouches to seal in juices and flavor.
4. **Conv bake** - Convection baking that uses a convection fan to circulate the oven heat for faster cooking of some foods.
5. **Conv roast** - Convection roasting uses a convection fan to gently brown the exterior of meats and poultry and seals in the juices.
6. **Perfect Turkey** - Used with meat probe to set turkey for precise cooking.
7. **Self Clean** - Use to select a self clean of between 2 and 4 hours.
8. **Steam Clean** - The steam clean feature offers a time saving method for cleaning light soils.
9. **No Preheat** - Best used for single rack baking with packaged and convenience foods.
10. **CANCEL** - Use to cancel any function previously entered except the time of day and minute timer.
11. **0 through 9 number keys** - Use to set times and temperatures and to set the clock to correct time of day.
12. **START** - Use to start all oven functions and to confirm user preferences settings.
13. **Cook time** - Use to set a specific cooking duration time which turns off the cooking process when the time expires.
14. **Delay start** - Use to program a cooking function to start at a specific time.
15. **Timer on-off** - Use to set or cancel the minute timer. The minute timers will not start or cancel cooking functions.

16. **Food probe** - Use the probe when cooking meats such as roasts, hams or poultry.
17. **Conv convert** - Converts standard temperature to convection temperature. This feature is only available when using convection bake.
18. **Keep warm** - Use to keep cooked foods at serving temperature. May be set to turn on after using cook time.
19. **Oven light** - Turns internal oven lights on and off.
20. **Set clock** - Use with numeric keys and START key to set clock. Clock must be set before oven will operate.
21. **Control lock** - Use to lock all oven functions including the oven door.

Feature	Mode	Min.Temp. /Time	Max Temp/Time
No Preheat		170°F (77°C)	550°F (288°C)
Bake		170°F (77°C)	550°F (288°C)
Sous Vide		100°F (38°C)	205°F (96°C)
Broil		400°F (205°C)	550°F (288°C)
Conv Bake		170°F (77°C)	550°F (288°C)
Conv Roast		170°F (77°C)	550°F (288°C)
Perfect Turkey		170°F (77°C)	550°F (288°C)
Food Probe		140°F (60°C)	210°F (99°C)
Keep Warm		170°F	3 Hours.
Timer		0:01 Min.	11:59 Hr./Min.
Clock Time	12 Hr.	1:00 Hr./Min.	12:59 Hr./Min.
	24 Hr.	0:00 Min	23:59 Hr./Min.
Delay Start	12 Hr.	1:00 Hr./Min.	12:59 Hr./Min.
	24 Hr.	0:00 Min	23:59 Hr./Min
Cook Time	12 Hr.	0:01 Min	5:59 Hr./Min.
	24 Hr.	0:01 Min	23:59 Hr./Min.
Self Clean		2 hours	4 hours

Setting the Clock

When the appliance is powered up for the first time or when the electric supply to the appliance has been interrupted, the display will flash **12:00** (Figure 7).



Fig. 7 12:00 displayed flashing when oven is powered up or power is restored after an interruption

To set the clock for 1:30:

1. Press **set clock**.
2. Enter **1 3 0** using numeric keypad.
3. Press **START** to accept time.

IMPORTANT! The clock cannot be changed when a cook time, self clean, delay start, or cooking feature is active.

- Be sure to set the clock to the correct time of day before using the oven, especially when cooking with added time instructions.
- If an invalid time of day is entered, the control will sound with a triple beep (error tone). Re-enter a valid time of day and press **START**.
- If **CANCEL** is pressed the clock will automatically set for **12:00**.

Changing Between Continuous Bake Setting or 12 Hour Energy Saving Feature

The oven control has a factory preset 12 hour energy saving feature that will turn off the oven after 12 hours. The control may be programmed to override this feature to bake continuously.

To change between continuous bake or 12 hour energy saving feature:

1. Press and hold **Timer on-off** until **12 Hr OFF** or **StAY On** appears in the display.
2. Press **self clean** to toggle between 12 Hour OFF or Stay On. (Figure 8)
3. Press **START** to accept choice.



Figure 8: 12 Hr OFF or Continuous Bake setting

Setting 12 Hour or 24 Hour display mode

The clock display mode allows you to select 12 hr or 24 hr modes. The factory pre-set clock display mode is 12 hours.

To set 12 hr or 24 hr display mode:

1. Press and hold **set clock** until **12 Hr** or **24 Hr dAY** appears.
2. Press **self clean** to toggle between **12 Hr day** or **24 Hr day** display modes (Figure 9).
3. Press **START** to accept the choice.



Figure 9: 12 Hr dAY and 24 Hr dAY settings

Setting Timer

The minute timer allows you to track your cooking times without interfering with the cooking process. The timer may be set from a minimum time of 1 minute to a maximum of 11 hours and 59 minutes.

To set timer for 5 minutes:

1. Press **Timer on-off**. The indicator light above the key will flash.
2. Enter **5** using numeric keypad.
3. Press **START** to start the timer. The indicator light remains on above the Timer on-off key.
4. When set time ends, **END** will show in the display, the indicator light will flash, and the control will beep three times every 30 seconds until **Timer on-off** is pressed.

To cancel the timer when active, press **Timer on-off**.

Important note:

- The timer does not start or stop the cooking process. It serves as an extra minute timer that will beep when the set time has run out. The timer may be used alone or while using any of the other oven functions.
- When timer is set for more than 1 hour it will display hours and minutes until 1 hour remains. When less than 1 hour remains, the display counts down in minutes and seconds. With less than 1 minute remaining, only seconds will display.
- If the timer is active during a cooking process, the timer will show in the display. To view the status of any other active oven function, press the key of the cooking function once and it will appear in the display for a few seconds.

Changing temperature display from Fahrenheit to Celsius

The electronic oven control is set to display °F when shipped from the factory. The display may be changed to show either °F or °C oven temperatures.

To change temperature display mode from °F to °C or from °C to °F:

1. Press and hold **broil** for 6 seconds.
2. Once **F (or C)** appears in the display, press **Self Clean** to toggle between Fahrenheit and Celsius temperature display modes (Figure 10).
3. Press **START** to accept the choice.

Important note:

The oven temperature display cannot be changed during the cooking process or if a delay start has been set or self clean is active.



Figure 10: Display showing Fahrenheit and Celsius

Setting Silent or Audible Control mode

Silent mode allows the oven control to operate without audible tones. The control may be programmed for silent operation and later reset to operate with all the normal audible tones.

To set for silent or audible mode:

1. Press and hold **delay start** until **bEEP On** or **bEEP OFF** appears in the display.
2. Press the **self clean** key to toggle between **bEEP On** or **bEEP OFF** (Figure 11).
3. Press **START** to accept the choice.



Figure 11: Display showing audible and silent operation

Setting Oven Lockout

The control may be programmed to lock the oven door and lock the oven control.

To activate the oven lockout features:

Be sure oven door is completely closed.

1. Press and hold **control lock** for 3 seconds. door **Loc** will appear in the display. The motor driven door latch mechanism will begin locking the oven door automatically. Do not open the oven door. Allow about 15 seconds for the oven door to completely lock. Once door is locked, **Loc** will appear in the display. (See Figure 11).



To cancel the oven lockout feature:

1. Press and hold **control lock** for 3 seconds. The motor door latch will begin unlocking the oven door automatically. Do not open the oven door. Allow about 15 seconds for the oven door to completely unlock.
2. When the **Loc** message no longer displays, the oven door may be opened, and the oven control will be available for use.

IMPORTANT!

To avoid possible damage to the oven door latching mechanism, do not attempt to open or close the oven door whenever the door **Loc** message is displayed.

If a control key is pressed when control lock is active, the control will triple beep, indicating the key is not available when the control lock feature is active.

Interior oven lights

The interior oven lights will automatically turn on when the door is open.

IMPORTANT! During the Sabbath mode the lights will not turn on. If the lights are needed for the Sabbath be sure to turn the lights on before entering into the Sabbath mode. The lights will remain on until the Sabbath mode is cancelled.

Press **Oven Light** to turn the interior oven light on and off whenever the oven door is closed.

The oven light will not operate during a fresh clean cycle.

The interior oven lights are located at the upper left and right rear wall of the oven interior and are covered with glass shields. The glass shield must be in place whenever the oven is in use.

No Preheat

No Preheat is available for single rack baking with packaged and convenience foods and can be programmed for temperatures between 170°F and 550°F. Follow the recipe or package directions for food preparation time and temperature.

⚠ CAUTION

Always use pot holders or oven mitts when using the oven. When cooking the oven interior, oven racks will become very hot which can cause burns.

During No Preheat function, the oven elements will cycle on and off. The convection fan will turn on and stay on until No Preheat is canceled. Depending on your preference for doneness cooking times may vary. Watch food closely.

Important:

- Always place food in center of the oven on rack position 3 (Figure 13). Place the food as shown in Figure 12 with the food closer to the front of the oven rack.
- No Preheat is designed for baking on a single oven rack, placed in the center of the oven.
- When using No Preheat, use bakeware with low or no sides. This allows the air to circulate around the food evenly.
- Leave oven light off when baking.
- Food that comes in strips, such as fish sticks and chicken tenders, should be placed on the pan with the ends pointing to the sides of the oven. Follow the package directions for food preparation time and temperature.
- Food may need to be removed early and should be checked at minimum recommended bake time.
- No Preheat works best when cooking foods longer than 10 minutes. If directions call for a shorter cooking time, a few extra minutes may be required for optimal cooking results.
- Do not open the oven door often. Opening the door will reduce the temperature in the oven and may increase bake time.

To set the No Preheat temperature for 350°F:

1. Arrange the interior oven racks.
3. Place food in oven and close oven door.
2. Press **no preheat**. **350** will appear in the display.



3. Press **START**.
4. **350** and **NO PRE** will be displayed.
5. Press **CANCEL** when baking is complete or to cancel the No Preheat feature.

To change preheat temperature while oven is preheating (ex: changing from 350°F to 425°F):

1. Press **4 2 5**.
2. Press **START**.
3. When baking is complete, press **CANCEL**.

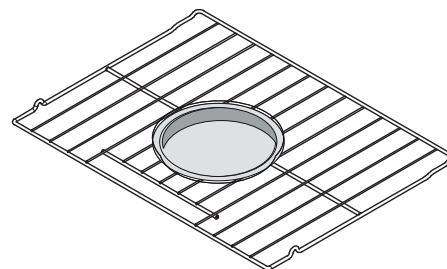

Figure 12: Single rack baking for convenience foods-- place food towards front of oven rack.

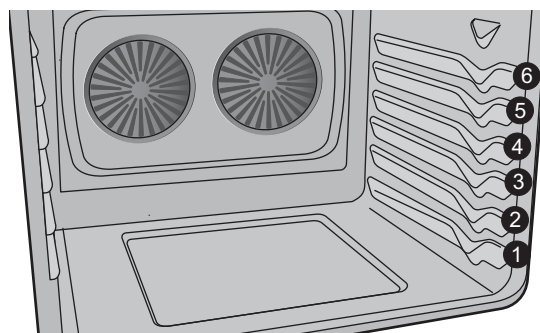

Figure 13: Oven rack positions (3) best for convenience foods.

Setting Bake

Use the bake feature whenever the recipe calls for baking using normal temperatures. A reminder tone will sound indicating when the set bake temperature is reached and to place the food in the oven. The convection fan will cycle on and off during preheat and after oven is fully preheated to allow best performance.

Bake may be set for any oven temperature between 170°F (77°C) and 550°F (288°C).

For best results

- Leave oven lights off while baking.
- For batter and dough-based baked goods such as cakes, pastries, and breads, use the convection bake function for best results.
- When using a single rack for baking, place in oven rack position 3.
- When baking cookies and biscuits use positions 3 (flat) and 5 (glide rack) or 6 (flat rack) for best results.
- For best results when baking cakes using 2 racks, place cookware on oven rack positions 1 and 4 (glide rack) or 5 (flat rack). (Figure 14)
- When using 2 oven racks for baking, position cookware allowing 2-4 inches (5-10cm) of space between the food items to ensure proper circulation. (Figure 15)

To set Bake with default temperature of 350°F:

1. Press **bake**.
2. Press **START**.

To cancel bake at anytime, press **CANCEL**.



To set Bake for oven temperature of 425°F:

1. Press **bake**.
2. Enter **4 2 5** using numeric keypad.
3. Press **START**.

To cancel bake at any time, press **CANCEL**.

IMPORTANT! The oven is factory set to run no longer than 12 hours. If you wish to cook continuously, see [“Changing Between Continuous Bake Setting or 12 Hour Energy Saving Feature”](#) on page 14.

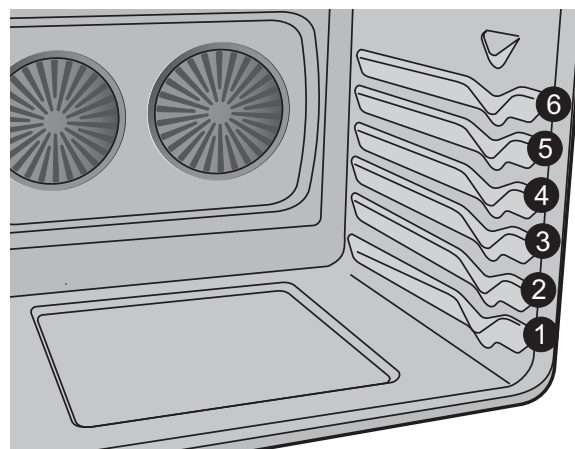

Fig. 14 Rack positions

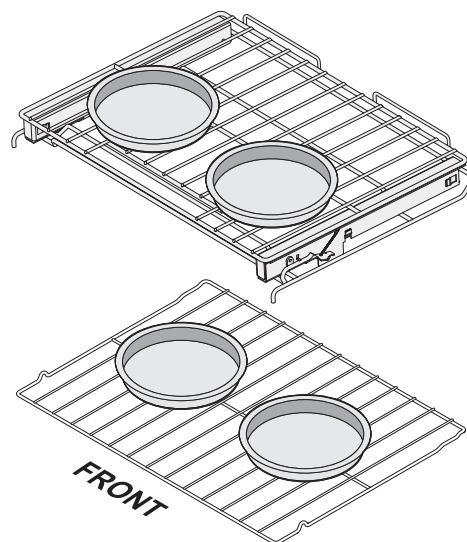

Figure 15: Pan spacing using multiple racks

Convection bake

Convection bake uses a fan to circulate the oven heat evenly and continuously (Figure 16). The improved heat distribution allows for even cooking with excellent results. Multiple rack cooking may slightly increase cook times for some food types, but the overall result will be time saved.

The **conv bake** feature should only be used when your recipe instructions have been written especially for convection baking.

If your recipe instructions are for baking and you wish to use conv bake, follow the conv convert option instructions. The conv convert option will automatically adjust the oven temperature so that convection baking will provide the best possible results.

Benefits of convection bake:

- Multiple oven racks.
- Foods cook more evenly.
- No special pans or bakeware required.

Convection baking tips: For best results it is recommended to preheat the oven before baking items like cookies, biscuits and breads.

- When using a single rack while baking, use rack position 3.
- For cookies use the following racks:
 - Single rack baking use 2 (glide rack) or 3 (flat rack).
 - Two rack baking use 3 (flat) and 5 (glide)-or 6 (flat).
 - Three rack baking 1 (flat), 3 (flat) and 5 (glide).
- For baking cakes use the following rack positions and place bakeware as shown in Figure 17.
 - In upper rack use position 4 (glide) or 5 (flat) and place bakeware closer to the front of the rack.
 - In lower rack (flat rack) use position 1 and place bakeware in the middle of the rack.
- Cookies and biscuits should be baked on pans with no sides or very low side to allow heated air to circulate around the food. Food items baked on pans with a dark finish will cook faster.

To set convection bake with the factory default temperature of 350° (176°):

1. Press **conv bake**.
2. **350°** will appear in the display.
3. Press **START**.



To stop conv bake at anytime press **CANCEL**.

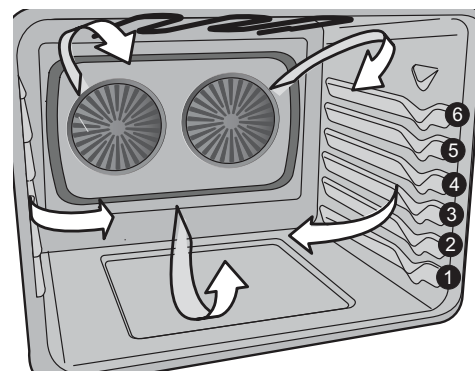

Fig. 16 Air circulation in convection mode

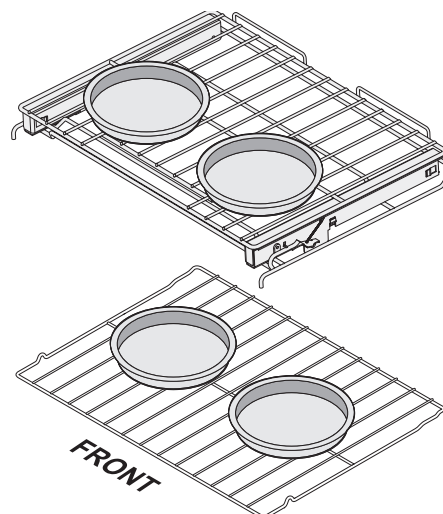

Fig. 17 Pans spaced for convection baking cakes on two racks.

Convection convert

The convection convert feature allows you to convert any normal baking recipe into a convection bake recipe. The control uses the normal recipe settings and adjusts to a lower temperature for convection baking. Conv convert must be used with conv bake and may be set with cook time or delay start instructions.

Benefits of convection convert:

- Multiple oven rack cooking.
- Some foods cook faster, saving time and energy.

Convection convert baking tips: For best results it is recommended to preheat the oven before baking items like cookies, biscuits and breads.

- When using a single rack while baking, use rack position 3.
- For cookies use the following racks:
 - Single rack baking use 2 (glide rack) or 3 (flat rack).
 - Two rack baking use 3 (flat) and 5 (glide)-or 6 (flat).
 - Three rack baking 1 (flat), 3 (flat) and 5 (glide).
- For baking cakes use the following rack positions and place bakeware as shown in [Figure 17](#).
 - In upper rack use position 4 (glide) or 5 (flat) and place bakeware closer to the front of the rack.
 - In lower rack (flat rack) use position 1 and place bakeware in the middle of the rack.
- Cookies and biscuits should be baked on pans with no sides or very low side to allow heated air to circulate around the food. Food items baked on pans with a dark finish will cook faster.

To set conv convert with the factory default oven temperature of 350°F (176°C):

1. Press **conv bake**.
2. Press **conv convert**.
3. Press **START**.
4. When activated, the control display will show **CONV BAKE** and the oven will begin heating. Once the oven reaches the set temperature a tone will sound indicating the oven is ready.

To stop **conv convert** at anytime press **CANCEL**.



When using **conv convert**, cook time reductions may vary depending on the oven temperature setting.

Using convection cooking with convection convert and cook time:

To set conv convert for 30 minutes with a temperature setting of 375°F (191°C):

1. Press **conv bake**.
2. Enter **3 7 5** using numeric keypad.
3. Press **conv convert**.
4. Press **START**.

IMPORTANT! When the preheat tone sounds place food in oven.

5. Press **cook time**.
 6. Enter **3 0**.
 7. Press **START**.
- The feature will provide a **CF** (check food) message in the display when cooking is 75% complete. **CF** will appear in the display for a few seconds along with an alert tone as a reminder to check food and appears at regular intervals until cooking ends.
 - When cooking is finished, **END** will appear in the display and the control will beep three times every 30 seconds until the function is canceled.

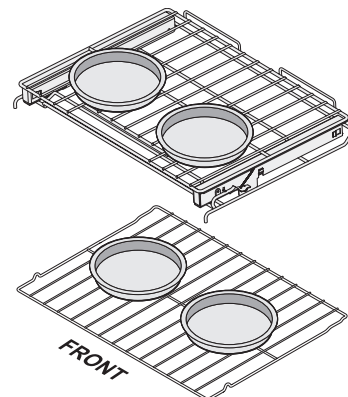

Fig. 18 Pans spaced for convection baking cakes on two racks.

Cook Time

The cook time feature is used when a recipe calls for a specific temperature and cook time. The maximum cook time setting is 11 hours, 59 minutes. Cook time instructions may be set with bake, broil, convection bake, convection roast, keep warm, and no preheat.

To bake for 30 minutes with the oven at default temperature setting of 350°F (176°C):

1. Press **bake**.
2. Press **START**.
3. When preheat tone sounds place food in oven.
4. Press **cook time** and enter **3 0** using numeric keys.
5. Press **START**.

Once active, the oven display the time of day and the oven temperature. To see the cook time remaining, press **cook time** once. (Figure 19) The remaining time will appear in the display for a few seconds before returning to show the time of day.

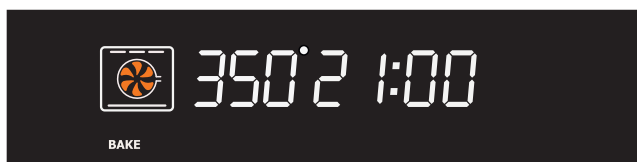

Figure 19: Display showing cook time remaining

The oven will bake at the set temperature for the full 30 minutes and then automatically shut off. The timed bake can be ended at any time by pressing **CANCEL**.

When the cook time runs out:

End will appear in the display window and the oven will shut off automatically. The control will beep and repeat every few seconds until the **CANCEL** is pressed.

To stop cooking at any time press **CANCEL**.

⚠ WARNING

FOOD POISONING HAZARD. Do not let food sit for more than one hour before or after cooking. Doing so can result in food poisoning or sickness.

⚠ CAUTION

Use caution when preparing foods with cook time and delay start instructions. Foods that can easily spoil such as milk, meat, fish or poultry, should be chilled in the refrigerator first. Even when chilled, they should not stand in the oven for more than one hour before cooking begins, and should be removed promptly when cooking ends.

Setting Cook Time with Delay Start

Adding a cook time with a specific delay start allows the user to control exactly when the cooking process will begin and end.

Cook time and delay start instructions may be set with bake, convection bake, broil, convection roast, and keep warm.

Before setting cook time instructions be sure the time of day is set correctly on the oven clock.

To set the oven to bake at 375°F (191°C) for 50 minutes and to automatically start at 5:30:

1. Press **bake**.
2. Enter **3 7 5** using numeric keypad.
3. Press **cook time**.
4. Enter **5 0** using numeric keypad.
5. Press **delay start**.
6. Enter **5 3 0** using numeric keypad.
7. Press **START**. Once **START** is pressed, the oven will hold the programmed bake until the delayed start time is reached.
8. When the delayed starting time is reached, the oven will automatically turn on and heat to the set temperature.
9. When cook time runs out: **End** will appear in the display window and the oven will shut off automatically. The control will beep three times every 30 seconds until canceled.

To stop cooking at any time press **CANCEL**.

IMPORTANT! Cook time may be added after preheating or anytime after pressing **START**.

Air Sous Vide

How Sous Vide Works

Sous vide is a French phrase meaning “under vacuum”. In sous vide cooking, food is vacuum-sealed in plastic pouches, which are then placed in a cooking medium of hot water or air. Your appliance uses hot air circulating around sealed pouches to cook food slowly at relatively low temperatures: 100°F to 205°F (38°C to 94°C). Sous vide cooking is not fast, but with a little planning, it can be very easy.

Advantages of Sous Vide

- Food does not lose flavor or aroma due to evaporation.
- Vitamins and minerals do not escape during cooking.
- The low cooking temperature leaves meat and fish more tender.
- Less spice is needed, as food keeps more of its natural flavor.
- The low cooking temperature greatly reduces the risk of overcooking. The food never gets hotter than the intended serving temperature.
- Timing is less critical. If different dishes are finishing at different times, food that has reached serving temperature can wait, since it stays at serving temperature in the cooking medium.

Food Safety

Because sous vide cooks at relatively low temperatures, **safe food handling is especially important.**

- Always keep raw food in safe conditions before you start cooking.
- Clean the raw food before you start cooking.
- Use [Table 1, “Recommended Sous Vide Cook Settings,”](#) to find the recommended cooking time and temperature for the food.
- Only use temperatures below 140°F (60°C) to cook foods that can be safely eaten raw.
- Food should be between 34°F and 37°F (normal refrigerator temperatures) when preparing to place food in sous vide vacuum pouch.
- Sous vide dishes are best served immediately after cooking. If food is not served immediately, use an ice bath to chill it quickly and then keep it refrigerated for up to 3 days.
- Do not use sous vide to reheat leftovers.
- Do not allow raw food to contact cooked food during preparation. Do not use the same tools on different food items without washing them.
- If the recipe includes raw eggs, keep the whites and yolks from touching the outsides of the shells.
- Blanching in boiling water or searing in a pan before sous vide cooking can destroy surface bacteria to improve food safety.
- Do not use Delay Start with the Sous Vide function.
- Do not use a meat probe with the Sous Vide function. Food needs to be sealed air-tight in a pouch for sous vide cooking.

Vacuum Sealing

Sous vide cooking in your oven requires a vacuum sealer and vacuum pouches. The pouch needs to be sealed so no air or liquid can leak out. A pouch that leaks will produce poor cooking results and may produce smoke and residue that can burn during future cooking or when using self-clean. Follow the instructions that come with your sealer and pouches.

- Use pouches that are specified for your sealer and for sous vide cooking.
- Do not reuse vacuum pouches.
- Put food in one layer in the pouch for even cooking.
- It is recommended to use one food portion per vacuum pouch.
- Use the highest possible vacuum setting for best cooking results.
- Make sure that the closure of the pouch is clean to get a good seal. If cooking at higher temperatures (above 160° F / 71° C), double-seal the pouch.

IMPORTANT! Vacuum pouches are solely for sous vide cooking and should not be used for regular baking or broiling.

Sous Vide Cooking

1. Prepare
 - Start with the freshest, highest quality food possible.
 - Clean and cut the ingredients.
2. Package
 - Place the ingredients in the plastic pouch for your vacuum sealer. Add seasonings for cooking.

Note: If cooking multiple items at once, you may want to write the contents on the outside of the pouches before filling and sealing them.

 - Vacuum seal the pouch, removing as much air as possible. Verify that you have achieved an air-tight seal.
 - If not cooking immediately, store the pouch in a refrigerator until ready to cook.

To cook sous vide:

1. Place the sealed pouch of food on **Rack 3** of the oven.
2. Press **sous vide**. The default temperature of 130°F will appear in the display.
3. Set the temperature for the food being cooked. (between 100°F (38°C) and 205°F (96°C)).
4. Press **START**.
5. Set oven timer.

IMPORTANT! Since sous vide cooking allows for a suggested minimum cooking time and a target time, it is recommended to set the timer to at least the minimum time or to any time up to the target suggested time. With sous vide cooking there is a maximum cooking time which allows the user more flexibility when cooking with no specific end time.

Note: Use the sous vide feature of your oven to cook the food (section reference). Use the settings recommended for the type of food in [Table 1, "Recommended Sous Vide Cook Settings,"](#).

6. Finish
 - Open the plastic pouch and remove the food.
 - You may finish the food with a final searing or grilling to achieve a nice crust and roast flavor.
 - Add final seasonings or sauces if needed.
 - Serve.

CAUTION

Even though sous vide cooks at relatively low temperatures, use care when handling the pouch and its contents, which will be hot to the touch.

CAUTION

Only use temperatures below 140°F (60°C) for cooking foods that can be safely eaten raw.

IMPORTANT! The U.S. Department of Agriculture states, "Rare fresh beef is popular, but you should know that cooking it to only 140°F (60°C) means some food poisoning organisms may survive." (Source: Safe Food Book, Your Kitchen Guide, USDA) The lowest temperature recommended by the USDA is 145°F (63°C) for medium rare fresh beef. For beef medium 160°F, well done 170°F (77°C). Visit the USDA Food Safety and Inspection website at www.fsis.usda.gov.

Table 1: Recommended Sous Vide Cook Settings

Food	Doneness	Temp	Cooking Time		
			Min	Target	Max
Beef					
Steak*	Rare	130° F / 54°-55° C	2 hours	3 hours	4 hours
Steak*	Medium Rare	135° F / 57°-58° C	2 hours	3 hours	4 hours
Steak*	Medium	145° F / 62°-63° C	2 hours	3 hours	4 hours
Steak*	Medium Well	150° F / 65°-66° C	2 hours	3 hours	4 hours
Steak*	Well	160° F / 71°-72° C	2 hours	3 hours	4 hours
Roast**	Rare	135° F / 57°-58° C	6 hours	7 hours	16 hours
Roast**	Medium Rare	140° F / 60° C	6 hours	7 hours	16 hours
Roast**	Medium	150° F / 65°-66° C	6 hours	7 hours	16 hours
Roast**	Medium Well	155° F / 68°-69° C	6 hours	7 hours	16 hours
Roast**	Well	160° F / 71°-72° C	6 hours	7 hours	16 hours
Chuck/Brisket**	Rare	140° F / 60° C	20 hours	24 hours	48 hours
Chuck/Brisket**	Medium Rare	150° F / 65°-66° C	20 hours	24 hours	48 hours
Chuck/Brisket**	Well	180° F / 82°-83° C	20 hours	24 hours	48 hours
Pork					
Chop**	Medium	150° F / 65°-66° C	2 hours	3 hours	4 hours
Chop**	Well	160° F / 71°-72° C	2 hours	3 hours	4 hours
Roast**	Medium	150° F / 65°-66° C	2 hours	3 hours	4 hours
Roast**	Well	160° F / 71°-72° C	2 hours	3 hours	4 hours
Shoulder/Belly**	Medium	160° F / 71°-72° C	10 hours	24 hours	48 hours
Shoulder/Belly**	Well	180° F / 82°-83° C	10 hours	24 hours	48 hours
Chicken**					
Parts	Tender	170° F / 76°-77° C	2 hours	2-1/2 hours	4 hours
Fish					
Steak	Tender	105° F / 40°-41° C	1 hour	1-1/2 hours	2 hours
Steak	Flaky	125° F / 51°-52° C	1 hour	1-1/2 hours	2 hours
Steak	Well	145° F / 62°-63° C	1 hour	1-1/2 hours	2 hours
Filet	Tender	105° F / 40°-41° C	45 minutes	1 hour	1-1/2 hours
Filet	Flaky	125° F / 51°-52° C	45 minutes	1 hour	1-1/2 hours
Filet	Well	145° F / 62°-63° C	45 minutes	1 hour	1-1/2 hours
Vegetables					
Squash	Cubes	180° F / 82°-83° C	1 hour	1-1/2 hours	4 hours
Roots	Sliced/Cubes	180° F / 82°-83° C	1 hour	1-1/2 hours	4 hours
Potatoes	Sliced/Cubes	200° F / 93°-94° C	1 hour	1-1/2 hours	4 hours
Fruit					
Warm/Ripe	Sliced/Cubes	155° F / 68°-69° C	45 minutes	105 minutes	2-1/2 hours
Soft	Purees	180° F / 82°-83° C	15 minutes	30 minutes	90 minutes
* Steak thickness based on 1.5". Thicker cuts may require longer times.					
**Beef, chicken, and pork need a minimum of 2 hours cooking time.					

Broil

Use the **broil** feature to cook meats that require direct exposure to radiant heat for optimum browning results. Broiling will produce smoke. If smoke is excessive, place food further away from the broil element. Broil with oven door closed.

⚠ WARNING

Should an oven fire occur, leave the oven door closed and turn the oven off. If the fire continues, throw baking soda on the fire or use a fire extinguisher. Do not put water or flour on fire. Flour can be explosive. Water can cause a grease fire to spread and cause personal injury.

⚠ CAUTION

Always use pot holders or oven mitts when working with a hot oven. When broiling, the oven interior, oven racks will become hot enough to cause burns.

⚠ CAUTION

Do not use the broiler pan without the insert. Do not cover the broil pan or insert with aluminum foil; the exposed grease could ignite.

⚠ CAUTION

To prevent food from contacting the broil element and to prevent grease splattering, use the broil pan and insert when broiling.

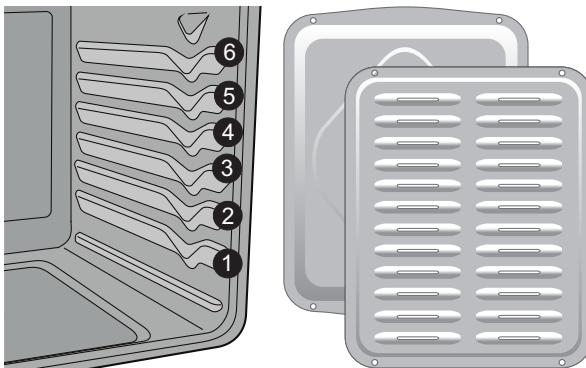

Fig. 20 Rack positions (L) Broil pan and insert (R)

- For optimum browning results, allow the oven to preheat for 2 minutes before placing meat in the oven. To avoid burning food, watch the food carefully when broiling and turn meat when needed.
- The broil pan insert has slots that allow grease and fat from the meat to drain into the broiler pan.

IMPORTANT! Broil Auto Shut Off: If oven door is open for more than one minute during Broil the control will beep. If door is not closed it will turn off Broil element after another 30 seconds.

Recommended Broiling Times

Use the broiling table (“[Suggested Setting when Broiling](#)” on page 25) for approximate recommended broiling times for the types of meat listed. Depending on the type, the thickness, and the desired doneness of meat, it might be necessary to increase or decrease broiling times or adjust the broiling pan to different rack positions.

If the food you are broiling is not listed in the table, follow the instructions provided in your recipe and watch the broiling process closely.

To set broil with the factory default temperature setting of 550°F (288°C):

1. Arrange the interior oven rack to rack position recommendations in desired oven for broiling.
2. Place the broiler insert on the broiler pan, then place the meat on the insert. Remember to follow all warnings and cautions.
3. Press **broil**. **Broil with oven door closed.**
4. Press **START**. Once activated, the oven display will show **BROIL** and will broil at the set temperature until cancelled. Allow oven to preheat for two minutes.
5. Place food in oven. Be sure to place the pan with the meat directly under the broil element and close door.
6. Turn meat when the first side is browned to the desired amount.

To change broil temperature while broiling:

- Press **broil**.
- Press desired temperature using numeric keypad (between 400°F and 550°F).
- Press **START**.

To stop **broil** at anytime press **CANCEL**.

IMPORTANT! Cook time and delay start may be added to the broil feature.

To set broil with a cook time and delay start once oven rack is arranged:

1. Press **cook time** and enter length of broiling time.
2. Press **delay start** and enter time.
3. Press **START**. The display will show the time of day and also **timed** and **delay**.

Suggested Setting when Broiling

Food	Rack Position	Oven Temp	Cook time in minutes 1st side	Cook time in minutes 2nd side	Internal Temp	Doneness
Steak 1" thick	5or 6*	550°F (288°C)	5	4	140°F (60°C)	Rare**
Steak 1" thick	5or 6*	550°F (288°C)	6	4	145°F (63°C)	Medium
Steak 1" thick	5or 6*	550°F (288°C)	7	5	160°F (71°C)	Med-well
Steak 1" thick	5or 6*	550°F (288°C)	8	7	170°F (77°C)	Well
Pork Chops 3/4" thick	6	550°F (288°C)	8	6	170°F (77°C)	Well
Chicken bone-in	5	450°F (232°C)	20	10	170°F (77°C)	Well
Chicken boneless	5	450°F (232°C)	8	6	170°F (77°C)	Well
Fish	5	500°F (260°C)	13	n/a	170°F (77°C)	Well
Shrimp	5	550°F (288°C)	5	n/a	170°F (77°C)	Well
Hamburger 1" thick	6	550°F (288°C)	9	7	145°F (63°C)	Medium
Hamburger 1" thick	6	550°F (288°C)	10	8	170°F (77°C)	Well

* Use the off-set rack or flat rack if you choose to use an oven rack in position 6* *The U.S. Department of Agriculture states, "Rare fresh beef is popular, but you should know that cooking it to only 140°F (60°C) means some food poisoning organisms may survive." (Source: Safe Food Book, Your Kitchen Guide, USDA) The lowest temperature recommended by the USDA is 145°F (63°C) for medium rare fresh beef. For well done cook to 170°F (77°C).

Convection Roast

Convection roast combines a cooking cycle with the convection fan and element to rapidly roast meats and poultry. Heated air circulates around the meat from all sides, sealing in juices and flavors. Meats cooked with this feature are crispy and brown on the outside while staying moist inside. There is no need to reduce the oven temperature when using convection roast. Convection roast may be set between 170°F (77°C) and 550°F (288°C).

Convection roast may be set with the following options:

- Cook time
- Cook time with delay start
- Probe

Convection roasting tips:

- Since convection roast cooks faster, reduce cook times by 25% from the recommended time of your recipe. Do not cover foods when dry roasting; covering will prevent the meat from browning properly.
- Be sure to carefully follow your recipe's temperature and time recommendations or refer to the convection roast recommendations for additional information on the next page.
- The convection fan will stop if oven door is opened. Opening door too often will reduce oven temperature and extend cooking time.

To properly arrange food for roasting:

1. Place food in center of oven or on oven rack position 1 or 2. Place the insert on the broiler pan.
2. Make sure the insert is securely seated on top of the broiler pan. Do not use the broiler pan without the insert. Do not cover the insert with aluminum foil.
3. Place meat on insert. Place prepared food on oven rack and slide into oven.

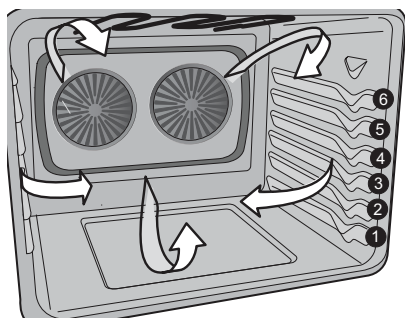

Figure 21: Air flow for convection roasting

To set convection roast with the factory default oven temperature setting of 350°F (176°C):

1. Press **conv roast**.
2. Press **START**.

When activated, the oven will begin heating.

To stop convection roast at anytime press **CANCEL**.



Preheating for convection roast will not be necessary for most meats and poultry.

When cooking meats using convection roast, it is recommended to use the broiler pan and insert along with the roasting rack. The broiler pan will catch grease splatters and the insert helps prevent grease splatters. The roasting rack fits on top of the insert allowing the heated air to circulate under the food for even cooking and helps to increase browning on the underside.

CAUTION

Do not use the broiler pan without the insert. Do not cover the broil pan or insert with aluminum foil; the exposed grease could ignite.

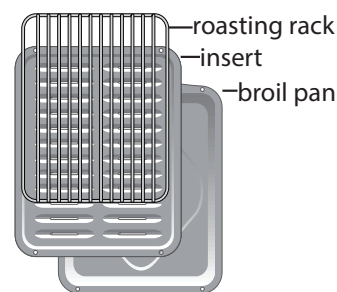

Fig. 22 Broil pan and insert with roasting rack

To change set temperature once convection roast is on:

1. Enter temperature change using numeric keypad.
2. Press **START**.

To stop convection roast at anytime press **CANCEL**.

Table 2: Convection roasting temperature and time recommendations

Meat		Weight	Oven Temp	Internal Temp	Minutes per lb.
Beef	Standing rib roast	4 to 6 lbs.	350°F (176°C)	160°F (71°C*)	25-30
	Ribeye roast	4 to 6 lbs.	350°F (176°C)	160°F (71°C*)	25-30
	Tenderloin roast	2 to 3 lbs.	400°F (204°C)	160°F (71°C*)	15-25
Poultry	Turkey whole**	12 to 16 lbs.	325°F (162°C)	180°F (82°C)	8-10
	Turkey whole**	16 to 20 lbs	325°F (162°C)	180°F (82°C)	10-15
	Turkey whole**	20 to 24 lbs.	325°F (162°C)	180°F (82°C)	12-16
	Chicken	3 to 4 lbs.	350°F-375°F (176°C -190°C)	180°F (82°C)	12-16
Pork	Ham roast, fresh	4 to 6 lbs.	325°F (162°C)	160°F (71°C*)	30-40
	Shoulder blade roast	4 to 6 lbs.	325°F (162°C)	160°F (71°C*)	20-30
	Loin	3 to 4 lbs.	325°F (162°C)	160°F (71°C*)	20-25
	Pre-cooked ham	5 to 7 lbs.	325°F (162°C)	160°F (71°C*)	30-40

* The U.S. Department of Agriculture states, "Rare fresh beef is popular, but you should know that cooking it to only 140°F (60°C) means some food poisoning organisms may survive." (Source: Safe Food Book, Your Kitchen Guide, USDA) The lowest temperature recommended by the USDA is 145°F (63°C) for medium rare fresh beef. For well done cook to 170°F (77°C).

** Stuffed turkey requires additional roasting time. Shield legs and breast with foil to prevent over browning and drying of the skin.

Food Probe

Checking the internal temperature of your food is the most effective way of insuring that your food has been properly cooked. When cooking meat such as roasts, hams or poultry you can use the food probe to check the internal temperature without any guesswork.

Your oven will automatically change to the **keep warm** function once the probe reaches the set internal temperature.

Setting the probe:

- Always insert the probe so that the tip rests in the center of the thickest part of the meat. Do not allow the probe to touch bone, fat, gristle or the pan.
- For bone-in ham or lamb, insert the probe into the center of the lowest large muscle or joint.
- For dishes such as meat loaf or casseroles, insert the probe into the center of the food. To find the center of the food visually measure with the probe.
- When cooking fish, insert the probe just above the gill.
- For whole poultry or turkey, insert the probe into the thickest part of the breast (Figure 23).

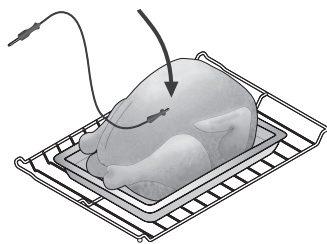
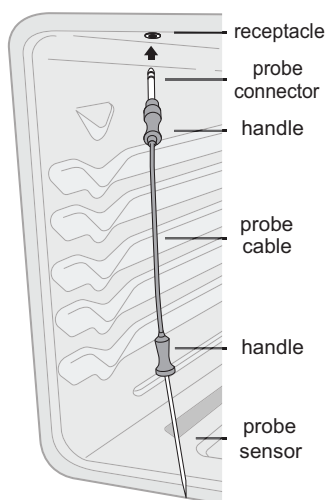

Figure 23: Proper placement for poultry

IMPORTANT!

- Use only the probe supplied with your appliance; any other may result in damage to the probe or the appliance.
- Be sure the probe is fully inserted into the probe receptacle. The probe receptacle is located at the top of the oven cavity. The probe will not work properly until correctly connected.
- Defrost your food completely before inserting the probe to avoid damaging probe.
- Never leave or store the probe inside the oven when not in use.



CAUTION

Handle the meat probe carefully when inserting and removing from food or probe receptacle. Do not use kitchen utensils, such as tongs, to pull on meat probe cable when inserting or removing from food or receptacle. Use the provided handle. To avoid possibility of burns after cooking, carefully unplug meat probe using a pot holder to protect hands.

Continue/Cancel Cooking

There may be times when you will want to continue or cancel cooking after the probe has reached the target temperature. Be aware that this setting cannot be changed during the cooking process or if a delay start has been set.

To set the oven to continue cooking after reaching the probe target temperature:

1. Press **food probe** and hold for 3 seconds. The **contin** or **cancel** message will appear in the display.
2. Press **self clean** and toggle until the **contin** message appears then press **START** to accept.

Figure 24: Food Probe set to continue cooking

1. To set the oven to cancel cooking and automatically start keep warm after reaching the probe target temperature:
2. Press **food probe** and hold for 3 seconds.
3. Press **self clean** and toggle until **cancel** message appears then press **START** to accept.

Figure 25: Food Probe set to cancel cooking.

Setting the Food Probe

See the example below to set the probe target temperature to 180°F (82°C) when using the convection roast feature with oven set temperature for 325°F (162°C). When the meat probe is connected to the receptacle and a cooking function is started, the display will show the current temperature reported by the meat probe.

⚠ CAUTION

Always use pot holders or oven mitts when using the oven. When cooking, the oven interior and exterior, as well as the oven racks, will become very hot which can cause burns.



The default internal temperature when setting the probe is 170°F (77°C).

1. Insert the probe into the food and place the food into the oven.
2. Plug the probe completely into the **probe receptacle** inside the oven and close the oven door.
3. The probe icon will appear in the display.
4. Press **conv roast**. The default temperature of 350°F (177°C) will appear. Enter 325°F (162°C) using the numeric keys. Press **START**.
5. Press **food probe** once and use the numeric keys to change the set internal food temperature to 180°F(82°C).
6. Press **START**.
7. When the internal temperature is reached, the oven will switch to the **keep warm** and hold the oven at 170°F (77°C) for up to three hours or until canceled.

IMPORTANT! To ensure that the oven will switch to keep warm, make sure that the food probe is set to cancel cooking as shown in C



Any time during the cooking process you may press **food probe** to see or modify the target temperature.

1. Press **food probe** once and use the numeric keys to change the set internal food temperature.
2. Press **START** to accept the change.

To change the conv roast temperature:

1. Press **conv roast** and use the numeric keys to set another temperature.
2. Press **START** to accept the change.

Minimal Internal Temperatures for Probe

Food type	Internal Temp
Beef, veal, lamb-roasts, steaks and chops	
Medium	160°F (71°C)
Well done	170°F (76°C)
Fresh pork-roasts, steaks, and chops	
Medium	160°F (71°C)
Well done	170°F (77°C)
Ham	160°F (71°C)
Poultry	
Whole chicken, turkey	165°F (74°C)
Poultry breasts, roasts	165°F (74°C)
Stuffing (cooked alone or in bird)	165°F (74°C)
Leftovers	165°F (74°C)

Information courtesy the U.S. Department of Agriculture Food Safety and Inspection Service.

The U.S. Department of Agriculture states, "Rare fresh beef is popular, but you should know that cooking it to only 140°F (60°C) means some food poisoning organisms may survive." (Source: Safe Food Book, Your Kitchen Guide, USDA) The lowest temperature recommended by the USDA is 145°F (63°C) for medium rare fresh beef.

⚠ WARNING

FOOD POISONING HAZARD. Do not let food sit for more than one hour before or after cooking. Doing so may cause bacteria to grow which can result in food poisoning or other illness.

Perfect Turkey

The perfect turkey feature uses the temperature probe to control precisely the cooking of a perfect turkey. The convection feature gently browns the turkey's exterior and seals in the juices. The temperature probe is required with this cooking mode. The oven can be programmed for Perfect Turkey at any temperature between 170°F to 550°F with default temperature of 325°F. The internal temperature setting for perfect turkey is automatically set for 170°F (77°C), but may be set between 140°F and 210°F (60°C to 99°C).

Perfect Turkey Tips:

- Thaw the turkey in the refrigerator at least 24 hours per 5 lbs before cooking the bird.
- Use the broiler pan and insert, and the roasting rack. The broiler pan will catch grease spills and the grid will help prevent spatters. The roasting rack will hold the turkey.
- Place an oven rack on rack position 1 or 2 (next-bottom) and center food in oven.
- Make sure the roasting rack is securely seated on the grid in the broiler pan. The roasting rack fits on the grid allowing the heated air to circulate under the food for even cooking and helps to increase browning on the underside.

To set Perfect Turkey:

1. Arrange interior oven racks in oven and place food in oven.
2. Insert the meat probe into the bird and connect it in the oven probe receptacle.
3. Press **perfect turkey**. The default oven temperature of 325°F (163°C) will appear in the display.



Figure 26: Oven set for perfect Turkey

4. Press **START**. The oven will cook until the internal temperature of the turkey (170° F (77°C) is reached.

To change the oven temperature while cooking:

1. Press **perfect turkey**. Press **numeric keys** to add new temperature
2. Press **START**.

IMPORTANT! If the oven has been set to **cancel** cooking, the oven will switch to **keep warm** 170° F (77°C) and remain at that temperature for up to three hours or until canceled.

To change the desired internal temperature of the turkey:

1. Press the **food probe**. Press numeric keys to change 170°F default temperature (range from 140°F to 210°F).
2. Press **START**.

Keep Warm

Use the keep warm feature to keep hot foods warm for up to three hours. Keep warm may be set with the following options:

- Cook Time
- Cook Time with Delay Start.
- Food Probe

IMPORTANT! When setting keep warm by itself, the preferred time can be set for any length of time between one minute and 11 Hours and 59 minutes. Unless a specific time is entered, the oven will remain on keep warm for 11 Hours and 59 minutes or until canceled.

WARNING

Food poisoning hazard. Do not food let sit for more than one hour before or after cooking. Doing so may cause bacteria to grow which can result in food poisoning or other illness.

To set keep warm:

1. Press **keep warm**.
2. Press **cook time**.
3. Enter the desired time.
4. Press **START**.
5. To end keep warm at any time press **CANCEL**.



When keep warm is added to a timed cooking function such as bake, conv bake, no preheat, or conv roast, the oven will automatically turn on after cook time is finished and keep warm and stay on for up to three hours or until canceled.

To add keep warm to a timed cooking function:

1. Select **bake, conv bake, conv roast, or no preheat**.
2. Enter desired cooking temperature using numeric keys.
3. Press **cook time**.
4. Enter desired cook time using numeric keys.
5. Press **keep warm**.
6. Press **START**.
7. When timed cooking ends the oven will start the keep warm function automatically and remain on for up to three hours.

Setting the Sabbath Mode

(For use on Jewish Sabbath and Holidays)



For further assistance, guidelines for proper usage and a complete list of models with the Sabbath feature, please visit the web at www.star-k.org.

This appliance provides special settings for use when observing the Jewish Sabbath/Holidays. Sabbath mode disables all audible tones or visual display changes on the oven control. Bake heating is the only cooking feature available while in the Sabbath mode. Oven controls are automatically locked during Sabbath mode.

You must first set the Bake feature and temperature(s) needed for the oven, and the cook time and delay start options (if needed). Any settings made prior to setting the Sabbath mode will be visible in the displays. The cook time option, if set prior to the Sabbath mode, will give one audible alert at the end of cook time.

The Sabbath mode will override the factory preset 12 Hour Energy Saving mode and the appliance will stay on until the cooking features are cancelled. If any of the cooking features are cancelled when the appliance is in the Sabbath mode, no audible or visual indicators will be available to verify the cancellation.

If the oven interior lights are needed, be sure to activate them prior to setting the Sabbath mode. Once the oven light is turned on and the Sabbath mode is active, the oven light will remain on until the Sabbath mode is turned off and the oven lights are turned off. The oven door will not activate the interior oven lights when the oven door is opened or closed.

It is recommended that any oven temperature modification made within an active Sabbath mode be followed with two (2) presses of the **START** key. This will insure the oven remains on even if an attempt is made to set the oven temperature outside of its temperature range. If the oven temperature is set outside of the temperature range, the oven will default to the nearest available temperature. Try to set the desired oven temperature again.

⚠ WARNING

Food Poisoning Hazard. Do not let food sit for more than one hour before or after cooking. Doing so can result in food poisoning or sickness. Foods that can easily spoil such as milk, eggs, fish, meat or poultry should be chilled in the refrigerator first. Even when chilled, they should not stand in the oven for more than 1 hour before cooking begins, and should be removed promptly when finished cooking.

To program oven to Bake with default oven temperature of 350°F and activate the Sabbath feature:

1. Be sure the clock is set with the correct time of day.
2. Arrange oven racks, place bakeware in oven and close oven door.
3. Press Bake. If cook time or delay start are not needed, skip this step. If a cook time or delay start is desired, enter the times at this point. Refer to [“Cook Time” on page 20](#) and [“Setting Cook Time with Delay Start” on page 20](#) for detailed instructions.
4. Press **START**.
5. Press and hold cook time and delay start simultaneously for about 3 seconds to set the Sabbath feature.
6. Once the feature is set, **SAb** will appear in the display indicating the oven is properly set for the Sabbath feature (Figure 26).



Figure 27: Oven in Sabbath mode

Do not attempt to activate any other oven function except Bake, START, and CANCEL while the Sabbath feature is active. The following keys will function correctly when the Sabbath feature is active: 0-9 number keys, Bake, and all other keys should not be used once the Sabbath feature is active.

You may change the oven temperature once baking has started. Use the numeric keys to enter the oven temperature change (170°F to 550°F) and press **START** (for Jewish Holidays only). Remember that the oven control will no longer provide audible tones or display any further changes when the Sabbath feature is active.

IMPORTANT! The oven will shut-off automatically after completing a cook time, delay start or keep warm and therefore may only be used once during the Sabbath/Jewish Holidays.

If a delay start time longer than 11 hours and 59 minutes is desired, set the oven control for the 24 hour day display mode setting. For detailed instructions see [“Setting 12 Hour or 24 Hour Display Mode” on page 10](#).

To cancel the Sabbath mode:

1. Press **CANCEL**.
2. Press and hold **cook time** and **delay start** for 3 seconds.
3. **SAB** will disappear from the display.
4. The oven may now be used for regular cooking.

What to do after a power failure or power interruption when Sabbath mode is active:

Should a power failure or interruption occur during the Sabbath holidays, the appliance will shut off. **SF** will appear in all the control display, indicating a Sabbath mode failure (Figure 28) Sabbath Failure mode will remain and the oven will not work until Sabbath mode is cancelled.



Figure 28: Display showing Sabbath failure

After Sabbath mode is cancelled, Sabbath mode settings may be entered again.

Adjusting Oven Temperatures

Your appliance has been factory calibrated and tested to ensure accurate baking temperatures. For the first few uses, follow your recipe times and temperature recommendations carefully. If you think the oven is cooking too hot or too cool for your recipe times, you may adjust the control so the oven cooks hotter or cooler than the oven temperature displayed.

IMPORTANT! Do not use oven thermometers such as those found in grocery stores to check the temperature settings inside your oven. These oven thermometers may vary as much as 20°F to 40°F degrees from actual temperatures. The oven temperature may be increased as much as +35°F (+19°C) or decreased -35°F (-19°C) from the factory calibrated settings.

To increase or decrease the oven temperature by 20°F:

1. Press and hold **bake** until factory offset temperature of **0** (zero) and **UPO** should appear in the display.

**Restoring Control to Factory Default Settings**

Your appliance is set with a number of predetermined oven control settings. Over time you may make changes to the original factory settings. The following functions or features have user programmable options or adjustments that may have been changed from the default settings.

- Clock 12-hour or 24-hour display mode
- 12 Hour Energy Savings or Continuous Bake mode
- Oven temperature display mode (F° or C°)
- Any oven temperature adjustment made (UPO)

IMPORTANT! Before restoring, be aware that any previous changes made to the oven control settings will be erased once the keypad is pressed. This includes any temperature offset made for the oven when baking.

To restore factory default settings:

1. Press and hold numeric key **7**.
2. The display will beep.
3. **rSt PS (reset press start)** will appear in the display.

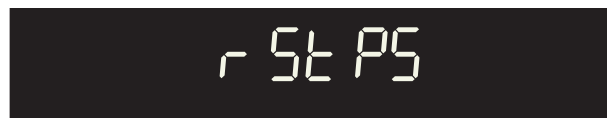

Figure 29: Control is ready to reset to default settings

4. Press **START** to accept the change.
5. The controls have been reset to the original factory settings.

2. Enter **2 0** using numeric keys. To offset the oven by -20°F, press **self clean** to toggle to the minus (-) setting.

Press **START** to accept change.



Oven temperature adjustments will not change the Broil or Self Clean function temperatures.

Self Clean

A self cleaning oven cleans with very high temperatures well above normal cooking temperatures. The high temperature eliminates soils completely or reduces them to a fine powdered ash you can wipe away afterwards with a damp cloth.

The self clean function allows you to set a cleaning time from 2 hours to 4 hours. A 3 hour cleaning time is recommended for normal cleaning, 2 hours for light cleaning, and 4 hours for heavy cleaning.

Read Before Starting Self Clean:

⚠ CAUTION

Do not leave small children unattended near the appliance. During the self cleaning cycle, the outside of the oven can become very hot to touch and can cause burns.

⚠ CAUTION

Do not line the oven walls, racks, bottom or any other part of the oven with aluminum foil. Doing so will destroy heat distribution, produce poor baking results and cause permanent damage to the oven interior. Aluminum foil will melt to the interior of the oven.

⚠ CAUTION

The health of some birds is extremely sensitive to the fumes given off during the self cleaning cycle of any oven. Move birds to another well-ventilated room.

⚠ CAUTION

Do not force the door open. This can damage the automatic door locking system. Use caution when opening the oven door after self cleaning. The oven may still be very hot and can cause burns. To avoid possible burns stand to the side of the oven when opening the oven door to allow hot air or steam to escape.

IMPORTANT! Completely remove all oven racks and any accessories from the oven cavity to avoid damage to oven racks. If the oven racks are not removed they may discolor.

The kitchen area should be well ventilated. Use an open window, ventilation fan or exhaust hood during the first self clean cycle to help eliminate the normal odors associated with the 1st self clean cycle.

Remove all items from the oven including bakeware, utensils and any aluminum foil. Aluminum foil will not withstand high temperatures from a self clean cycle and will melt.

Do not use oven cleaners or oven protective coatings in or around any part of the oven interior.

Clean any soil from the oven frame, the door liner outside the oven door gasket and the small area at the front center of the oven bottom (Figure 30). These areas heat sufficiently to burn soil on. Clean using soap and water prior to starting self clean.

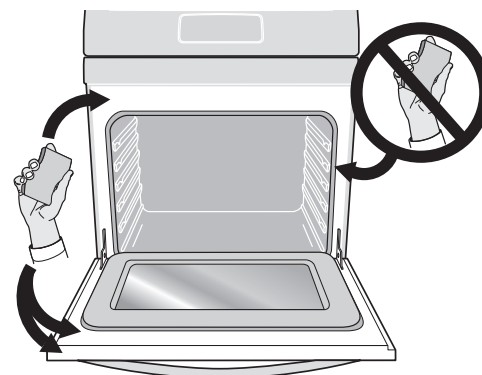

Figure 30: Oven door area to clean and not clean (gasket).

Do not clean the oven door gasket (Figure 30). The woven material of the oven door gasket is essential for a good seal. Care should be taken not to rub, damage or remove the gasket. Do not use any cleaning materials on the oven door gasket. Doing so could cause damage to the door gasket.

Remove any excessive build up caused by spills. Any spill on the oven bottom should be wiped up and removed before starting a self clean cycle. To clean, use hot, soapy water and a cloth. Large spill residue can cause heavy smoke or fire when subjected to high temperatures. Do not allow food spills with a high sugar or acid content (such as milk, tomatoes, sauerkraut, fruit juices or pie filling) to remain on the surface as they may leave a dull spot even after cleaning.

To set self clean for a 3 hour clean:

1. Be sure the oven is empty. Removing oven racks is recommended. Make sure door is closed.
2. Press **self clean** and the default 3 hour clean time will appear in the display.

IMPORTANT! If another time between 2 and 4 hours is desired, use the numeric keypad to select the time.

3. Press **START** to activate self clean.

As soon as self clean becomes active, a motor driven lock mechanism will begin locking the oven door automatically and the lock icon will appear in the display. Do not open the oven door when the lock icon is displayed (allow 15 seconds for the lock mechanism to lock the oven). Once the oven door has locked, **CLn** will appear in the display indicating self clean has started.

When Self Clean is finished:

Use caution when opening the oven door after self cleaning. The oven may still be very hot and can cause burns. To avoid possible burns stand to the side of the oven when opening the oven door to allow hot air or steam to escape.

The oven bake and broil elements may appear to have cooled after they have been turned off. The elements may still be hot and burns may occur if these elements are touched before they have cooled.

The **Cln** message will turn off, and Hot will appear in display window.

When **lock icon (padlock)** disappears from the display, the oven may be opened.

When the oven interior has completely cooled, wipe away any residue or powdered ash with a damp cloth or paper towel.

When the clean time finishes the oven door will remain locked until the oven has cooled sufficiently. In addition to the clean time that was programmed, allow about 1 additional hour for the oven to cool before opening the oven door. The self clean function will not operate when the oven lockout is active.

Setting Delay Start Self Clean

To start a delay self clean with default clean time of 3 hours and a start time of 9:00 o'clock:

Be sure the clock is set with the correct time of day, the oven is empty and all oven racks are removed. Be sure oven door is completely closed.

1. Press **self clean**.
2. Press **delay start**.
3. Using numeric keys enter **9 0 0** for time to start.

Press **START**.

If it becomes necessary to stop self clean when active:

Press **CANCEL**. The lock icon will flash.

If self clean has heated the oven to a high temperature, allow enough time for the oven to cool. When the lock icon disappears from the display, the oven may be opened.

Before restarting self clean, be sure to read important notes below:

- When self clean is active you may check the amount of clean time remaining by pressing the **self clean** key once.
- If your clock is set with the (default) 12 hr display mode, the delay start for a self clean can only be programmed to start up to 11 hours and 59 minutes after the time showing in the display (be sure to set the clock to current time before programming a delay start). To set a delay start self clean to begin 12 or more hours (maximum is 23 hours and 59 minutes) after the time of setting, be sure to first set the control in the 24 Hr display mode.
- If self clean was active and then interrupted by a power failure or cancelled before the oven was thoroughly cleaned, it may be necessary to run another self clean cycle.
- If the oven temperature was high enough when self clean was interrupted the oven control may not allow another self clean cycle to be set for up to 4 hours.

Steam Clean

The steam clean feature offers a chemical free and time saving method to assist in the routine cleaning of small and light soils. For heavier baked on soils use the self clean feature.

⚠ CAUTION

Do not add bleach, ammonia, oven cleaner, or any other abrasive household cleaners to the water used for steam clean. Before cleaning any part of the oven, be sure all controls are turned off and the oven is cool. The oven may be hot and can cause burns.

Be sure the oven is level and cool before starting steam clean. If the oven temperature is above room temperature a triple beep will be heard and the function will not start. Steam clean produces best results when started with a cool oven.

To set a steam clean cycle:

1. Remove all racks and oven accessories.
2. Scrape or wipe loose debris and grease from the oven bottom.
3. Pour 2 cups of tap water onto the oven bottom. (Figure 31) Close oven door.

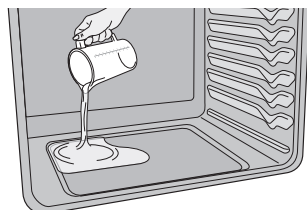

Figure 31: Add 2 cups of tap water

4. Press **steam clean**.
5. Press **START**. **St C** will appear in the display.



To see the time remaining in the steam clean cycle press **cook time** once. When steam clean is operating, the display will show the time of day.



To check on the time remaining in steam clean press **cook time** once and the remaining time will appear momentarily.

Do not open the door during this time. If door is open while in steam clean (d-O) will appear in the display.

When the steam clean cycle is complete an alert will sound and the END message will show in the display.

Press **CANCEL** to return to the clock.

⚠ CAUTION

Take care opening the door when the steam clean is finished. Stand to the side of the oven out of the way of escaping vapor.

Wipe oven cavity and bottom. Do not clean oven door gasket (Figure 36). Avoid leaning or resting on the oven door glass while cleaning cavity.

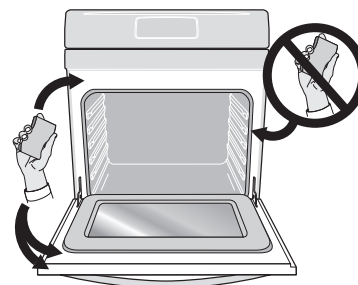

Figure 32: Clean around the oven door gasket

To cancel steam clean at any time press **CANCEL**.

Notes:

- Opening oven door during steam clean cycle prevents the water from reaching the temperature needed to clean.
- For best results, clean oven immediately after the cycle is complete. Steam clean works best for soils on the oven bottom.
- Place a paper towel or cloth in front of the oven to capture any water that may spill while wiping out.
- A non abrasive scouring pad, stainless steel sponge, plastic scraper, or eraser style cleaning pad (without cleaner) can be used for difficult soils. Moisten pads with water before use.
- Do not leave the residual water in the oven for any length of time.
- Some condensation or water vapor may appear close to the oven vent. This is normal. The oven gasket may become damp; do not wipe dry.
- Local water sources often contain minerals (hard water). If hard water deposits occur, wipe cavity with a 50/50 solution of water and vinegar or 50/50 solution of lemon juice and water.
- Steam clean cannot be programmed with a delay start.

If steam clean results are not satisfactory, run a self clean. See "Self Clean" on page 33.

CARE AND CLEANING

Cleaning Various Parts of Your Oven

⚠ CAUTION

Before cleaning any part of the appliance, be sure all controls are turned off and the appliance is cool.

⚠ CAUTION

If ammonia or appliance cleaners are used, they must be removed and the appliance must be thoroughly rinsed before operating. Follow manufacturer's instructions and provide adequate ventilation.

Remove spills and any heavy soiling as soon as possible. Regular cleaning will reduce the difficulty of major cleaning later.

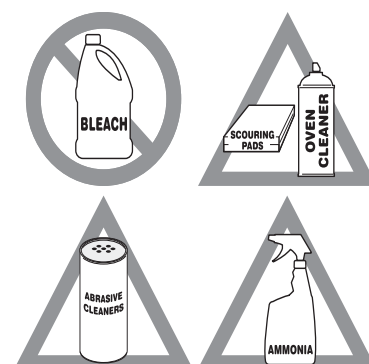

Figure 33: Use cleaners with caution

Before cleaning any part of the oven, be sure all controls are turned off and the oven is cool. Remove spills and any heavy soiling as soon as possible. Regular cleaning will reduce the difficulty and time of major cleaning later.

Surface Type	Recommendation
Aluminum and Vinyl	Using a soft cloth, clean with mild dish detergent and water. Rinse with clean water, dry and polish with a soft, clean cloth.
Painted body parts	Using a soft cloth, clean with mild dish detergent and water or a 50/50 solution of vinegar and water. Rinse with clean water, dry and polish with a soft, clean cloth. Glass cleaners may be used, but do not apply directly to surface; spray onto cloth and wipe.
Decorative trims	Glass cleaners may be used if sprayed on a soft cloth first. Do not spray liquids directly on the oven control and display area. Do not use large amounts of water on the control panel. Excess water on the control area may cause damage to the appliance. Do not use other liquid cleaners, abrasive cleaners, scouring pads, or paper towels. They will damage the finish.
Control Panel	Using a soft cloth, clean with mild dish detergent and water or a 50/50 solution of vinegar and water. Do not spray liquids directly on the oven control and display area. Do not use large amounts of water on the control panel - excess water on the control area may cause damage to the appliance. Do not use other liquid cleaners, abrasive cleaners, scouring pads, or paper towels - they will damage the finish.
Porcelain enamel broiler pan and insert	Gentle scouring with a soapy scouring pad will remove most spots. Rinse with a 1:1 solution of clear water and ammonia. If necessary, cover difficult spots with an ammonia-soaked paper towel for 30 to 40 minutes. Rinse with clean water and a damp cloth, and then scrub with a soap-filled scouring pad. Rinse and wipe dry with a clean cloth. Remove all cleaners or the porcelain may become damaged during future heating.
Door liner and body parts	
Oven racks	Oven racks and ladder racks must be removed from oven cavity before the clean cycle for cleaning. Clean by using a mild, abrasive cleaner following manufacturer's instructions. Rinse with clean water and dry.
Glide racks	For instructions on how to care for your glide racks, see "Caring for Your Glide Racks" on page 38

Oven door	<p>Use soap and water to thoroughly clean the top, sides, and front of the oven door. Rinse well. You may use a glass cleaner on the outside glass of the door. Do not immerse the door in water. Do not spray or allow water or the glass cleaner to enter the door vents. Do not use oven cleaners, cleaning powders, or any harsh abrasive cleaning materials on the outside of the oven door.</p> <p>The oven gasket located on the inner frame of the door and visible when the door is opened is essential for a good seal. Do not clean the oven door gasket. On fresh clean models, the oven door gasket is made of a woven material. Care should be taken not to rub, damage, or remove this gasket.</p>
Oven Interior	<p>Remove oven racks from the oven cavity before cleaning the oven interior. Use a mild, abrasive cleaner following manufacturer's instructions. Rinse with clean water and dry.</p>
Stainless Steel (some models)	<p>Only use cleaners and polishes that are specifically manufactured for cleaning stainless steel. Always rub in direction of metal grain to avoid damaging. Do not use cleaners with high concentrations of chlorides or chlorine. Do not use harsh scrubbing cleaners. Polish with a lint-free cloth. Always be sure to wipe excess cleaner/polish off from the metal surface as bluish stains may occur during future oven heating that cannot be removed. Clean heavier soils with hot, soapy water and a cloth or sponge. Rinse and dry using clean water and a cloth.</p>

Caring for Your Glide Racks

⚠ CAUTION

Handle oven racks only when they are cool. After cooking or after the fresh-clean cycle, racks will be very hot and can cause burns.

Important Notes:

- Remove all oven racks, including ladder racks, before starting a clean cycle.
- Do not use cooking oil, cooking spray, or other oil-based lubrication products on the glide rack extension tracks. Use only the graphite lubrication in this area. To order graphite lubrication, contact your installer, servicer or dealer.
- It is important that the parts of the rack that contact the oven sides always have a light coating of vegetable oil. Apply a thin layer of vegetable oil to the sides of the rack after every fresh-clean cycle and when the rack becomes difficult to reposition in the oven.

To lubricate the glide rack:

1. Remove the rack from the oven and place the rack on a large flat surface covered with newspaper or scrap cloth. Fully extend the rack.
2. Wipe away debris and crumbs from the glide track using a cloth or sponge.

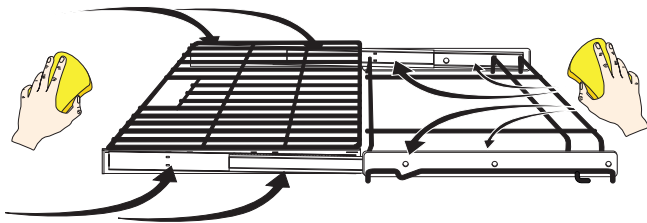

3. Shake graphite lubrication very well before applying. Place four drops of graphite lubrication along the tracks (see area circled on figure below). Repeat on both sides of the glide rack.

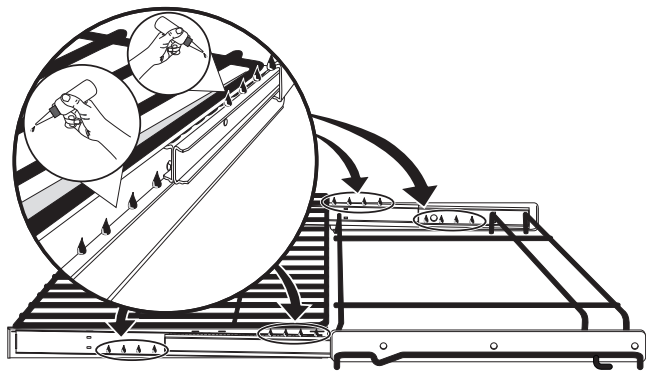

4. Extend and return the glide rack several times along the tracks to distribute the lubrication.

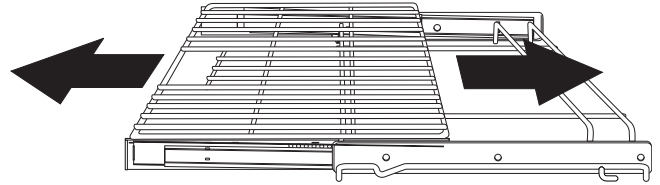

5. Turn glide rack over. Shake graphite lubrication very well before applying. Place four drops of graphite lubrication along the tracks. Repeat on both sides of the glide rack.

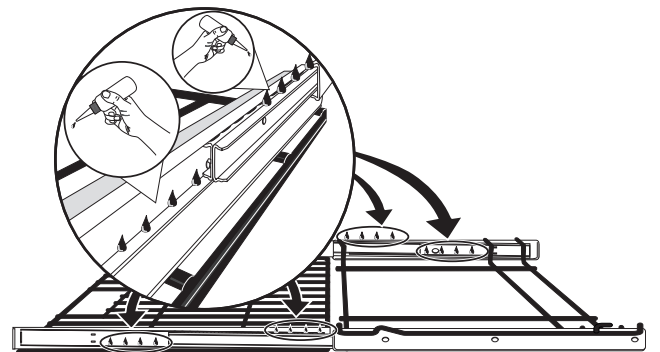

6. Extend and return the glide rack several times along the tracks to distribute the lubrication.

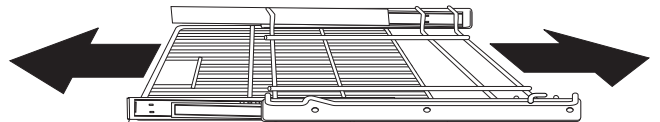

7. Apply a thin layer of cooking oil to the outer frame of the glide rack as shown below. Keeping the frame sides lightly lubricated allows the entire rack to slide easily when changing rack positions.

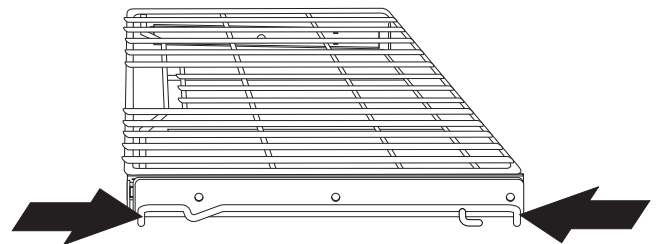

8. Replace rack in oven right-side up.

Removing and Replacing the Oven Door

To remove the oven door:

⚠ CAUTION

The door is heavy. For safe, temporary storage, lay the door flat with the inside of the door facing down.

⚠ WARNING

To prevent possible burns, do not attempt to remove the oven door until the oven has completely cooled.

1. Open oven door completely, horizontal with floor.
2. Pull up the lock located on each hinge support toward front of the oven. You may have to apply a little upward pressure on the lock to pull it up (Figure 35 and Figure 36).
3. Grasp the door by the sides, pull the bottom of the door up and toward you to disengage the hinge supports.
4. Keep pulling the bottom of the door toward you while rotating the top of the door toward the appliance to completely disengage the hinge levers (Figure 37).

To Replace Oven Door:

1. Firmly grasp both sides of oven door along the door sides. Do not use the oven door handle (Figure 37).
2. Holding the oven door at the same angle as the removal position, seat the hook of the hinge arm over the roller pins located on each side of the oven door frame (Figure 37). The hook of the hinge arms must be fully seated onto the roller pins.
3. Fully open the oven door, horizontal with floor (Figure 34).
4. Push the door hinge locks up toward and into the oven frame on both left and right oven door hinges to the locked position (Figure 35).
5. Close the oven door.

IMPORTANT!

Special Door Care Instructions - Most oven doors contain glass that can break. Do not close the oven door until all the oven racks are fully in place. Do not hit the glass with pots, pans, or any other object. Scratching, hitting, jarring, or stressing the glass may weaken its structure causing an increased risk of breakage at a later time.



Figure 34: Door at horizontal position

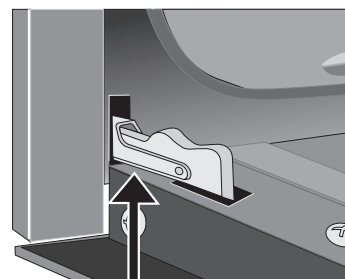

Figure 35: Door hinge locks

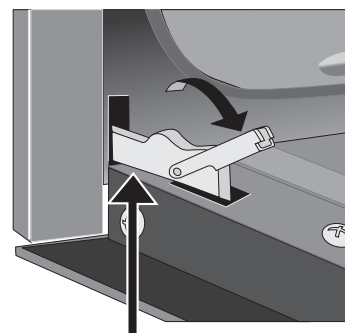

Figure 36: Hinge: unlocked position

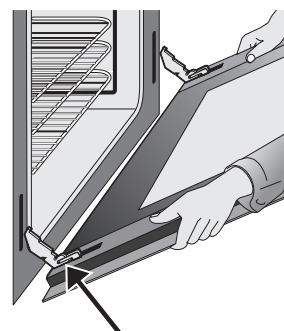

Figure 37: Holding door for removal

Replacing the Dual Left/Right Corner Oven Lights

The interior oven lights are located at the rear of the oven cavity and are covered with a glass shield. The glass shield must be in place whenever the oven is in use (Figure 38).

To replace the oven interior light bulb:

CAUTION

Be sure the oven is unplugged and all parts are cool before replacing oven light. Wear a leather-faced glove for protection against possible broken glass.

1. Turn electrical power off at the main source.
2. Remove interior oven light shield by turning a quarter turn counter-clockwise.
3. Replace bulb with a new T-4 type Halogen 25 watt appliance bulb.



Do not allow your fingers to touch the new bulb when replacing. This will shorten the life of the bulb. Use a paper towel or cotton glove while handling the new bulb when installing.

4. Replace glass oven light shield by rotating clockwise.
5. Turn power back on again at the main source (or plug the appliance back in).
6. Be sure to reset the time of day on the clock.

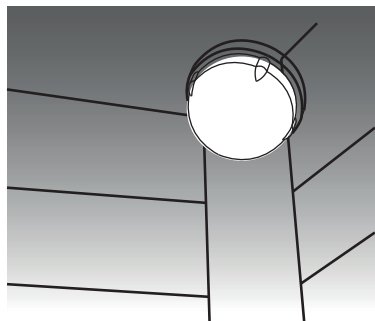

Figure 38: Wall oven Halogen light

Broiler Pan Cleaning Tips

To make cleaning easier, line the bottom of the broiler pan with aluminum foil. Do not cover the broiler grid with foil.

To prevent grease from baking on, remove the broiler pan from the oven as soon as cooking is completed. Use hot pads because the broiler pan is extremely hot. Pour off grease. Soak the pan in hot, soapy water.

Clean the broiler pan as soon as possible after each use. If necessary, use soap-filled steel wool pads. Heavy scouring may scratch the grid.

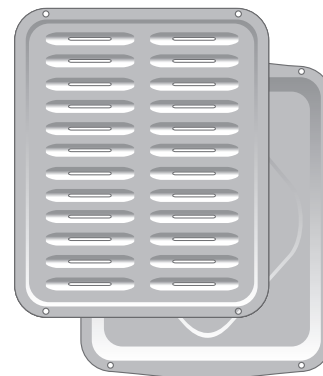

Figure 39: Broiler pan and grid

Aluminum Foil and Oven Liners

Do not use oven bottom liners or use aluminum foil to cover the oven racks.

CAUTION

Protective liners—Do not use aluminum foil to line the oven bottom, except as suggested in the manual. Improper installation of these liners may result in a risk of electrical shock, or fire.

Using a liner in the oven restricts the heat and air flow needed to obtain the best possible cooking results for any oven.

During fresh clean the oven temperature can become hot enough to melt aluminum cooking utensils or aluminum foil if left in the oven. This could result in permanent damage to the oven interior and porcelain finish.

BEFORE YOU CALL

Solutions to Common Problems

Baking Problems and Solutions

For best cooking results, heat the oven before baking cookies, breads, cakes, pies or pastries, etc. There is no need to preheat the oven for roasting meat or baking casseroles.

The cooking times and temperatures needed to bake a product may vary slightly from your previously owned appliance.

Cookies and biscuits burn on the bottom.



- Cookies and biscuits put into oven before the preheating time is completed.
- Oven rack is overcrowded.
- Dark pans absorb heat too fast.
- Allow oven to preheat to desired temperature before placing food in oven.
- Choose pan sizes that will permit 2" to 4" of air space (5.1 cm o 10.2 cm) on all sides when placed in the oven.
- Use a medium weight baking sheet.

Cakes too dark on top or bottom.



- Cakes put in oven before preheating time is completed.
- Rack position too high or too low.
- Oven too hot.
- Allow oven to preheat to the selected temperature before placing food in the oven.
- Use proper rack position for baking needs.
- Set oven temperature 25°F/13°C lower than recommended.

Cakes not done in center.



- Oven too hot.
- Incorrect pan size.
- Pan not centered in oven.
- Set oven temperature 25°F/13°C lower than recommended.
- Use pan size suggested in recipe.
- Use proper rack position and place pan so there is 2" to 4" (5.1 cm to 10.2 cm) of space on all sides of pan.

Cakes not level.



- Oven not level.
- Pan too close to oven wall or rack overcrowded.
- Pan warped.
- Oven light left on while baking.
- Place a marked glass measuring cup filled with water on the center of the oven rack. If the water level is uneven, refer to the installation instructions for leveling the oven.
- Be sure to allow 2" to 4" (5.1 cm to 10.2 cm) of clearance on all sides of each pan in the oven.
- Do not use pans that are dented or warped.
- Turn off oven light while baking.

Foods not done when cooking time is over.

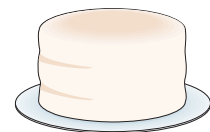

- Oven too cool.
- Oven overcrowded.
- Oven door opened too frequently.
- Set oven temperature 25°F/13°C higher than suggested and bake for the recommended time.
- Be sure to remove all pans from the oven except the ones to be used for baking.
- Open oven door only after shortest recommended baking time.

Before you call for service, review the following list. The list includes common occurrences that are not the result of defective workmanship or materials in this appliance. It may save you time and expense.

Problem	Solution
Appliance is not level	Be sure floor of the cabinet or built-in is level, strong and stable enough to adequately support oven. If floor is sagging or sloping, contact a carpenter to correct the situation. Poor installation. Kitchen cabinet alignment may make oven appear not level. Be sure cabinets are square and have sufficient room for appliance clearance.
Cannot move appliance easily. Appliance must be accessible for service	Cabinets not square or are built in too tightly. Contact builder or installer to make appliance accessible.
Oven Problems	
Poor baking results.	Many factors affect baking results. Use proper oven rack position. Center food in the oven and space pans to allow air to circulate. Preheat the oven to the set temperature before placing food in the oven. Try adjusting the recipe's recommended temperature or baking time. See "Adjusting Oven Temperatures" on page 32 if you feel the oven is too hot or too cool.
Oven light does not work.	Be sure the oven light is secure in the socket. See "Replacing the Dual Left/Right Corner Oven Lights" on page 40 .
Flames inside oven or smoking from oven vent.	Excessive spills in oven. Grease or food spilled onto the oven bottom or oven cavity. Wipe up excessive spills before starting the oven. If flames or excessive smoke are present when using broil, see "Broil" on page 24 .
Oven smokes excessively when broiling.	Incorrect setting. Follow the "Broil" instructions on page 24 . Meat too close to the broil element or burner. Reposition the broil pan to provide proper clearance between the meat and broil element or burner. Remove excess fat from meat. Cut remaining fatty edges to prevent curling, but do not cut into lean. Grease build up on oven surfaces. Regular cleaning is necessary when broiling frequently. Grease or food splatters will cause excessive smoking.
Oven control panel beeps and displays any F or E code error.	Oven control has detected a fault or error condition. To clear the error, press the OFF key on the control panel. Once the error code is cleared, try the bake or broil function. If the F or E code error repeats, turn off the power to appliance, wait 5 minutes, and then repower the appliance. Set the clock with correct time of day. Try the bake or broil function again. If the fault recurs, press the OFF key to clear.
Oven racks discolored or do not slide easily.	Oven racks left in oven cavity during self clean. Remove oven racks from oven cavity before starting a self-clean cycle. Clean by using a mild abrasive cleaner following manufacturer's instructions. Rinse with clean water, dry, and replace in oven.
Glide racks do not slide smoothly	Glide racks need lubrication. For instructions on how to care for your oven racks, See "Caring for Your Glide Racks" on page 38 .

Questions or for service call: 1-877-4 ELECTROLUX (1-877-435-3287)

Self Clean Problems

Problem	Solution
Self Clean does not work or is performing poorly	<p>Review steps for “Read Before Starting Self Clean.” beginning on page 33.</p> <p>Perform the following check: Press Broil; Press START. Place your hand near the handle on the oven door. Between the door and the control panel you should feel a rush of air on your hand. If so, your unit is functioning properly and you have had a Power Failure in your home. If no air stream is present, call a service technician to replace your cooling fan.</p>
Soil not completely removed after self clean.	<p>Self clean was interrupted. Review instructions on “Self Clean” on page 33.</p> <p>Excessive spills on oven bottom. Remove excessive spills before starting self clean.</p> <p>Failure to clean soil from the oven frame, the door liner outside the oven door gasket, and the small area at the front center of the oven bottom. These areas are not in the self-cleaning area, but get hot enough to burn on residue. Clean these areas before starting the self-cleaning cycle. Burned-on residue can be cleaned with a stiff nylon brush and water or a nylon scrubber. Be careful not to damage the oven gasket.</p>

WARRANTY

Your appliance is covered by a one year limited warranty. For one year from your original date of purchase, Electrolux will repair or replace any parts of this appliance that prove to be defective in materials or workmanship when such appliance is installed, used, and maintained in accordance with the provided instructions. In addition, the glass cooktop or radiant surface element of your appliance (excluding built-in and free-standing range appliances) is covered by a two through five year limited warranty. During the 2nd through 5th years from your original date of purchase, Electrolux will provide a replacement glass cooktop or radiant surface element for your appliance which has proven to be defective in materials or workmanship when such appliance is installed, used, and maintained in accordance with the provided instructions.

Exclusions

This warranty does not cover the following:

7. Products with original serial numbers that have been removed, altered or cannot be readily determined.
8. Product that has been transferred from its original owner to another party or removed outside the USA or Canada.
9. Rust on the interior or exterior of the unit.
10. Products purchased "as-is" are not covered by this warranty.
11. Products used in a commercial setting.
12. Service calls which do not involve malfunction or defects in materials or workmanship, or for appliances not in ordinary household use or used other than in accordance with the provided instructions.
13. Service calls to correct the installation of your appliance or to instruct you how to use your appliance.
14. Expenses for making the appliance accessible for servicing, such as removal of trim, cupboards, shelves, etc., which are not a part of the appliance when it is shipped from the factory.
15. Service calls to repair or replace appliance light bulbs, air filters, water filters, other consumables, or knobs, handles, or other cosmetic parts.
16. Labor or in-home service costs during the additional limited warranty periods beyond the first year from your original date of purchase.
17. Pickup and delivery costs; your appliance is designed to be repaired in the home.
18. Surcharges including, but not limited to, any after hour, weekend, or holiday service calls, tolls, ferry trip charges, or mileage expense for service calls to remote areas, including the state of Alaska.
19. Damages to the finish of appliance or home incurred during transportation or installation, including but not limited to floors, cabinets, walls, etc.
20. Damages caused by: services performed by unauthorized service companies; use of parts other than genuine Electrolux parts or parts obtained from persons other than authorized service companies; or external causes such as abuse, misuse, inadequate power supply, accidents, fires, or acts of God.

DISCLAIMER OF IMPLIED WARRANTIES; LIMITATION OF REMEDIES

CUSTOMER'S SOLE AND EXCLUSIVE REMEDY UNDER THIS LIMITED WARRANTY SHALL BE REPAIR OR REPLACEMENT AS PROVIDED HEREIN. **CLAIMS BASED ON IMPLIED WARRANTIES, INCLUDING WARRANTIES OF MERCHANTABILITY OR FITNESS FOR A PARTICULAR PURPOSE, ARE LIMITED TO ONE YEAR OR THE SHORTEST PERIOD ALLOWED BY LAW, BUT NOT LESS THAN ONE YEAR.** ELECTROLUX SHALL NOT BE LIABLE FOR CONSEQUENTIAL OR INCIDENTAL DAMAGES SUCH AS PROPERTY DAMAGE AND INCIDENTAL EXPENSES RESULTING FROM ANY BREACH OF THIS WRITTEN LIMITED WARRANTY OR ANY IMPLIED WARRANTY. SOME STATES AND PROVINCES DO NOT ALLOW THE EXCLUSION OR LIMITATION OF INCIDENTAL OR CONSEQUENTIAL DAMAGES, OR LIMITATIONS ON THE DURATION OF IMPLIED WARRANTIES, SO THESE LIMITATIONS OR EXCLUSIONS MAY NOT APPLY TO YOU. THIS WRITTEN WARRANTY GIVES YOU SPECIFIC LEGAL RIGHTS. YOU MAY ALSO HAVE OTHER RIGHTS THAT VARY FROM STATE TO STATE.

If You Need Service

Keep your receipt, delivery slip, or some other appropriate payment record to establish the warranty period should service be required. If service is performed, it is in your best interest to obtain and keep all receipts. Service under this warranty must be obtained by contacting Electrolux at the addresses or phone numbers below.

This warranty only applies in the USA, Puerto Rico and Canada. In the USA and Puerto Rico, your appliance is warranted by Electrolux Major Appliances North America, a division of Electrolux Home Products, Inc. In Canada, your appliance is warranted by Electrolux Canada Corp. Electrolux authorizes no person to change or add to any obligations under this warranty. Obligations for service and parts under this warranty must be performed by Electrolux or an authorized service company. Product features or specifications as described or illustrated are subject to change without notice.

USA

1-877-435-3287

Electrolux Major Appliances North America
10200 David Taylor Drive
Charlotte, NC 28262

Canada

1-800-265-8352

Electrolux Canada Corp.
5855 Terry Fox Way
Mississauga, Ontario, Canada L5V 3E4

electrolux.com/shop



CE

