



Use & Care Guide

27"/30" Electric/Microwave Combination Wave-Touch™ Wall Oven



 **Electrolux**

Table of contents

Finding information	2
Safety	3-8
Information You Need To Know	9-11
Features	12-15
Getting Started	16-17
• Power up, control display modes & timers	16
• Control lock & oven lights	17
Settings for Best Results	18-19
Setting Microwave Controls	20-29
• Time cooking	20
• Quick sensor.....	21
• Sensor cook.....	23
• Auto cook.....	24
• Auto reheat	26
• Melt, soften	27
• Auto defrost	28
• Multi stage cooking	29
Setting Lower Oven Controls	30-52
• Rapid preheat	30
• Bake	31
• Using cook time	32
• Using cook time with end time	33
• Broil	34-35
• Convection bake.....	36
• Using convection convert	37
• Convection roast.....	38-39
• Probe	40-41
• Convection broil.....	42
• Keep warm	43
• Slow cook	44
• Perfect Turkey™	45
• Defrost.....	46
• Dehydrate	46-47
• Bread proof.....	47
• Saving & recalling my favorite recipes.....	48
• Multi stage cooking.....	49-50
• Setting Sabbath mode.....	51-52
Setting Your Preferences	53-57
• Setting clock	53
• Setting clock display (CLO)	53
• Setting 12 or 24 hour mode (CLO).....	54
• Changing between F° or C° (F-C).....	54
• Setting 12hr energy saving mode (ES).....	55
• Setting audio mode (AUD).....	55
• Adjusting oven temperature (UPO)	56
• Factory default reset (RST)	56
• User preferences chart	57
Lower Oven Self-Clean	58-59
Lower Oven Care & Cleaning	60-64
• Cleaning recommendations.....	60-61
• Oven door removal	62-63
• Changing oven lights	64
Microwave Care & Cleaning	65
Solutions to Common Problems	66-68
Microwave Service Call Check	69
Warranty	71

Please read & save this guide

Thank you for choosing **Electrolux**, the new premium brand in home appliances. This *Use & Care Guide* is part of our commitment to customer satisfaction and product quality throughout the service life of your new appliance.

We view your purchase as the beginning of a relationship. To ensure our ability to continue serving you, please use this page to record important product information.

Keep a record for quick reference

Purchase date

Electrolux model number

Electrolux serial number

Serial plate location



NOTE

Registering your product with Electrolux enhances our ability to serve you. You can register online at www.electroluxappliances.com or by dropping your Product Registration Card in the mail.

Questions?

For toll-free telephone support in the U.S. and Canada:

1-877-4ELECTROLUX (1-877-435-3287)

For online support and Internet production information visit <http://www.electroluxappliances.com>

What you need to know about safety instructions

Warning and Important Instructions appearing in this guide are not meant to cover all possible conditions and situations that may occur. Common sense, caution and care must be exercised when installing, maintaining or operating a microwave.

ALWAYS contact your dealer, distributor, service agent or manufacturer about problems or conditions you do not understand.

Recognize Safety Symbols, Words, Labels



WARNING

WARNING — Hazards or unsafe practices which **COULD** result in severe personal injury or death.



CAUTION

CAUTION — Hazards or unsafe practices which **COULD** result in minor personal injury.

PRECAUTIONS TO AVOID POSSIBLE EXPOSURE TO EXCESSIVE MICROWAVE ENERGY

Adhere to the following precautions:

- **DO NOT** attempt to operate the microwave oven with the door open since open-door operation can result in harmful exposure to microwave energy. It is important not to defeat or tamper with the safety interlocks.
- **DO NOT** place any object between the oven front face and the door or allow soil or cleaner residue to accumulate on sealing surfaces.
- **DO NOT** operate the oven if it is damaged. It is particularly important that the oven door close properly and that there is no damage to the: (1) door (bent), (2) hinges and latches (broken or loosened), (3) door seals and sealing surfaces.
- The oven should not be adjusted or repaired by anyone except properly qualified service personnel.

4 Important Safety Instructions

WARNING

When using electrical appliances, basic safety precautions should be followed to reduce the risk of burns, electric shock, fire, injury to persons or exposure to excessive microwave energy:

- **READ ALL** instructions before using the appliance.
- **READ AND FOLLOW** the specific “PRECAUTIONS TO AVOID POSSIBLE EXPOSURE TO EXCESSIVE MICROWAVE ENERGY”.
- Install or locate this appliance only in accordance with the provided installation instructions.
- Some products such as whole eggs and sealed containers - for example, closed jars - are able to explode and **SHOULD NOT** be **HEATED** in this oven.
- Use this appliance **ONLY** for its intended use as described in this manual. Do not use corrosive chemicals or vapors in this appliance. This type of oven is specifically designed to heat, cook or dry food. It is not designed for industrial or laboratory use.
- As with any appliance, **CLOSE SUPERVISION** is necessary when used by **CHILDREN** or **INFIRM PERSONS**.
- This appliance, including power cord, must be serviced **ONLY** by qualified service personnel. Contact nearest Electrolux Authorized Servicer for examination, repair or adjustment.
- **DO NOT** cover or block any vents or openings on the oven.
- **DO NOT** store or use this appliance outdoors.
- **DO NOT** use this product near water—for example, near a kitchen sink, in a wet basement, near a swimming pool, or similar locations.
- Review the door cleaning instructions on page 61 (oven door) and 65 (microwave door).

CAUTION

To reduce the risk of fire in the oven cavity:

- **DO NOT overcook food. Carefully attend to appliance when paper, plastic or other combustible materials are placed inside the oven to facilitate cooking.**
- Remove wire twist-ties from paper or plastic bags before placing bag in oven.
- **If materials inside the oven ignite, keep oven door closed, turn oven off and disconnect the power cord or shut off power at the fuse or circuit breaker panel.**
- **DO NOT** use the cavity for storage purposes. **DO NOT** leave paper products, cooking utensils or food in the cavity when not in use.

Liquids, such as water, coffee or tea are able to be overheated beyond the boiling point without appearing to be boiling. Visible bubbling or boiling when the container is removed from the Microwave Oven is not always present. **THIS COULD RESULT IN VERY HOT LIQUIDS SUDDENLY BOILING OVER WHEN A SPOON OR OTHER UTENSIL IS INSERTED INTO THE LIQUID.**

To reduce the risk of injury to persons:

- **DO NOT** overheat the liquid.
- Stir the liquid both before and halfway through heating it.
- Do not use straight-sided containers with narrow necks. Use a wide-mouthed container.
- After heating, allow the container to stand in the Microwave Oven at least for 20 seconds before removing the container.
- Use extreme care when inserting a spoon or other utensil into the container.

If the microwave oven light fails, consult a Electrolux Authorized Servicer.

Recognize safety symbols, words and labels

Safety items throughout this manual are labeled with a WARNING or CAUTION based on the risk type as described below:

WARNING

This symbol alerts you to situations that may cause serious body harm, death or property damage.

CAUTION

This symbol alerts you to situations that may cause bodily injury or property damage.

Read all of the following safety instructions before using this appliance:

- **Remove all tape and packaging before using the appliance.** Destroy the carton and plastic bags after unpacking the appliance. Never allow children to play with packaging material.
- **Proper Installation—Be sure your appliance is properly installed and grounded by a qualified technician in accordance with the National Fuel Gas Code ANSI Z223- latest edition, or in Canada CAN/CGA B149.1 and CAN/GGA B149.2, and the National Electrical Code ANSI/NFPA No.70-latest edition, or in Canada CSA Standard C22.1, Canadian Electrical Code, Part 1, and local code requirements.** Install only per installation instructions provided in the literature package for this appliance.

Ask your dealer to recommend a qualified technician and an authorized repair service. Know how to disconnect the power to the appliance at the circuit breaker or fuse box in case of an emergency.
- **User servicing—Do not repair or replace any part of the appliance unless specifically recommended in the manuals.** All other servicing should be done only by a qualified technician. This may reduce the risk of personal injury and damage to the appliance.
- **Never modify or alter the construction of an appliance by removing leveling legs, panels, wire covers, anti-tip brackets/screws, or any other part of the product.**

WARNING

- All appliance can tip.
- Injury to persons could result.
- Install anti-tip device packed with appliance.
- See Installation Instructions.

To reduce the risk of tipping, the unit must be secured by properly installed anti-tip bracket provided with the unit. Refer to the installation instructions for proper anti-tip installation.



WARNING

- **Never Use Your Appliance for Warming or Heating the Room.**
- **Do not use the oven or microwave oven for storage.**
- **Stepping, leaning or sitting on the doors of this appliance can result in serious injuries and also cause damage to the unit.** Do not allow children to climb or play around the unit. The weight of a child on an open door may cause the appliance to tip, resulting in serious burns or other injury.

CAUTION

Do not store items of interest to children in the cabinets above the unit. Children climbing on the appliance to reach items could be seriously injured.

6 Important Safety Instructions

- **Protective liners**—Do not use aluminum foil to line the oven bottom, except as suggested in the manual. Improper installation of these liners may result in a risk of electrical shock, or fire.
- **Storage in or on Appliance—Flammable materials should not be stored in an oven.** This includes paper, plastic and cloth items, such as cookbooks, plasticware and towels, as well as flammable liquids. Do not store explosives, such as aerosol cans, on or near the appliance.
- **Do not leave children alone—Children should not be left alone or unattended in the area where appliance is in use.** They should never be allowed to sit or stand on any part of the appliance.
- **DO NOT TOUCH HEATING ELEMENTS OR INTERIOR SURFACES OF THE OVENS OR ANY AREAS NEAR THESE ZONE.** ALL oven heating elements may be hot even though they are dark in color. Areas near surface zones may become hot enough to cause burns. During and after use, do not touch, or let clothing or other flammable materials touch these areas until they have had sufficient time to cool. Among these areas are the oven vent openings and surfaces near these openings, oven door and window.
- **Wear proper apparel—Loose-fitting or hanging garments should never be worn while using the appliance.** Do not let clothing or other flammable materials contact hot surfaces.
- **Do not use water or flour on grease fires—Smother the fire with a pan lid, or use baking soda, a dry chemical or foam-type extinguisher.**
- **When heating fat or grease, watch it closely.** Fat or grease may catch fire if allowed to become too hot.
- **Use only dry potholders - Moist or damp potholders on hot surfaces may result in burns from steam.** Do not let potholders touch hot heating elements. Do not use a towel or other bulky cloth instead of a potholder.
- **Do not heat unopened food containers - Buildup of pressure may cause container to burst and result in injury.**

IMPORTANT

Do not attempt to operate the unit during a power failure. If the power fails, always turn off the unit. If the unit is not turned off and the power resumes, the unit will begin to operate again. Once the power resumes, reset the clock and oven function.

- **Remove the oven door from any unused appliance if it is to be stored or discarded.**

Important instructions for using your oven

- **Use care when opening an oven door**—Stand to the side of the unit when opening the door of a hot oven. Let hot air or steam escape before you remove or replace food in the oven.
- **Keep oven vent ducts unobstructed.** The oven vents are located under the control panel and in between the ovens. Touching the surfaces in this area when the oven is operating may cause severe burns. Also, do not place plastic or heat-sensitive items on or near the oven vent. These items could melt or ignite.
- **Placement of oven racks.** Always place oven racks in desired location while oven is cool. If rack must be moved while oven is hot use extreme caution. Use potholders and grasp the rack with both hands to reposition. Do not let potholders contact the hot heating elements in the oven. Remove all utensils from the rack before moving.
- **Do not use the broiler pan without its insert.** The broiler pan and its insert allow dripping fat to drain and be kept away from the high heat of the broiler.
- **Do not cover the broiler insert with aluminum foil. Exposed fat and grease could ignite.**

- **Cold temperatures** can damage the electronic control. When using the appliance for the first time, or when the appliance has not been used for an extended period of time, be certain the unit has been in temperatures above 32°F (0°C) for at least 3 hours before turning on the power to the appliance.

Important instructions for cleaning your appliance

- **Clean the appliance regularly to keep all parts free of grease that could catch fire.** Pay particular attention to the area underneath each surface element. Do not allow grease to accumulate.
- **Kitchen cleaners and aerosols—Always follow the manufacturer's recommended directions for use.** Be aware that excess residue from cleaners and aerosols may ignite causing damage and injury.
- **Clean ventilating hoods frequently—Grease should not be allowed to accumulate on the hood or filter.** Follow manufacturer's instructions for cleaning.

Self cleaning ovens

- **Clean in the self-cleaning cycle only the parts listed in this Use & Care Manual.** Before self cleaning the oven, remove the broiler pan and any utensils or foods from the oven.
- **Do not use oven cleaners—**No commercial oven cleaner or oven liner protective coating of any kind should be used in or around any part of the oven.
- **Do not clean door gasket—**The door gasket is essential for a good seal. Care should be taken not to rub, damage or move the gasket.
- The health of some birds is extremely sensitive to the fumes given off during the self-cleaning cycle of any oven. Move birds to another well-ventilated room.

Important safety notice

The California Safe Drinking Water and Toxic Enforcement Act requires the Governor of California to publish a list of substances known to the state to cause cancer, birth defects or other reproductive harm, and requires businesses to warn customers of potential exposure to such substances.

SAVE THESE INSTRUCTIONS FOR
FUTURE REFERENCES

8 Important Safety Instructions

Federal Communications Commission Radio Frequency Interference Statement (U.S.A. Only)

This equipment generates and uses ISM frequency energy and if not installed and used properly, that is in strict accordance with the manufacturer's instructions, may cause interference to radio and television reception. It has been type tested and found to comply with limits for ISM Equipment pursuant to part 18 of FCC Rules, which are designed to provide reasonable protection against such interference in a residential installation.

However, there is no guarantee that interference will not occur in a particular installation. If this equipment does cause interference to radio or television reception, which can be determined by turning the equipment off and on, the user is encouraged to try to correct the interference by one or more of the following:

- Reorient the receiving antenna of the radio or television.
- Relocate the microwave oven with respect to the receiver.
- Move the microwave oven away from the receiver.
- Plug the microwave oven into a different outlet so that the microwave oven and the receiver are on different branch circuits.

The manufacturer is not responsible for any radio or television interference caused by **unauthorized modification** to this microwave oven. It is the responsibility of the user to correct such interference.

About your oven

This Use and Care Guide is valuable: read it carefully and always save it for reference.

A good microwave cookbook is a valuable asset. Check it for microwave cooking principles, techniques, hints and recipes.

NEVER use the Microwave Oven without the turntable and support nor turn the turntable over so that a large dish could be placed in the oven. The turntable will turn both clockwise and counterclockwise.

ALWAYS have food in the Microwave Oven when it is on to absorb the microwave energy.

When using the Microwave Oven at power levels below 100%, you may hear the magnetron cycling

on and off. It is normal for the exterior of the oven to be warm to the touch when cooking or reheating.

Condensation is a normal part of microwave cooking. Room humidity and the moisture in food will influence the amount of moisture that condenses in the oven. Generally, covered foods will not cause as much condensation as uncovered ones. Ventilation openings must not be blocked.

The Microwave Oven is for food preparation only. It should not be used to dry clothes or newspapers.

Your Microwave Oven is rated 900 watts by using the IEC Test Procedure. In using recipes or package directions, check food a minute or two before the minimum time and add time accordingly.

About safety

- Check foods to see that they are cooked to the United States Department of Agriculture's recommended temperatures.

Temp	Food
160°F	For fresh pork, ground meat, boneless white poultry, fish, seafood, egg dishes and frozen prepared food.
165°F	For leftover, ready-to-reheat refrigerated, and deli and carry-out "fresh" food.
170°F	White meat of poultry.
180°F	Dark meat of poultry.

To test for doneness, insert a meat thermometer in a thick or dense area away from fat or bone. NEVER leave the thermometer in the food during cooking, unless it is approved for microwave use.

- ALWAYS use potholders to prevent burns when handling utensils that are in contact with hot food. Enough heat from the food can transfer through utensils to cause skin burns.

- Avoid steam burns by directing steam away from the face and hands. Slowly lift the farthest edge of a dish's covering and carefully open popcorn and oven cooking bags away from the face.
- Stay near the oven while it's in use and check cooking progress frequently so that there is no chance of overcooking food.
- NEVER use the cavity for storing cookbooks or other items.
- Select, store and handle food carefully to preserve its high quality and minimize the spread of foodborne bacteria.
- Keep waveguide cover clean. Food residue can cause arcing and/or fires.
- Use care when removing items from the oven so that the utensil, your clothes or accessories do not touch the safety door latches.
- Keep aluminum foil used for shielding at least 1 inch away from walls, ceiling and door.

About microwave cooking

- Arrange food carefully. Place thickest areas towards outside of dish.
- Watch cooking time. Cook for the shortest amount of time indicated and add more as needed. Food severely overcooked can smoke or ignite.
- Cover foods while cooking. Check recipe or cookbook for suggestions: paper towels, wax paper, microwave plastic wrap or a lid. Covers prevent splattering and help foods to cook evenly.
- Shield with small flat pieces of aluminum foil any thin areas of meat or poultry to prevent overcooking before dense, thick areas are cooked thoroughly.
- Stir foods from outside to center of dish once or twice during cooking, if possible.
- Turn foods over once during microwaving to speed cooking of such foods as chicken and hamburgers. Large items like roasts must be turned over at least once.
- Rearrange foods such as meatballs halfway through cooking both from top to bottom and from the center of the dish to the outside.
- Add standing time. Remove food from oven and stir, if possible. Cover for standing time which allows the food to finish cooking without overcooking.
- Check for doneness. Look for signs indicating that cooking temperatures have been reached.
- Doneness signs include:
 - Food steams throughout, not just at edge.
 - Center bottom of dish is very hot to the touch.
 - Poultry thigh joints move easily.
 - Meat and poultry show no pinkness.
 - Fish is opaque and flakes easily with a fork.

About food

Food	Do	Don't
Eggs, sausages, nuts, seeds, fruits & vegetables	<ul style="list-style-type: none"> • Puncture egg yolks before cooking to prevent "explosion". • Pierce skins of potatoes, apples, squash, hot dogs and sausages so that steam escapes. 	<ul style="list-style-type: none"> • Cook eggs in shells. • Reheat whole eggs. • Dry nuts or seeds in shells.
Popcorn	<ul style="list-style-type: none"> • Use specially bagged popcorn for microwave cooking. • Listen while popping corn for the popping to slow to 1 or 2 seconds or use special popcorn pad. 	<ul style="list-style-type: none"> • Pop popcorn in regular brown bags or glass bowls. • Exceed maximum time on popcorn package.
Baby food	<ul style="list-style-type: none"> • Transfer baby food to small dish and heat carefully, stirring often. Check temperature before serving. • Put nipples on bottles after heating and shake thoroughly. "Wrist" test before feeding. 	<ul style="list-style-type: none"> • Heat disposable bottles. • Heat bottles with nipples on. • Heat baby food in original jars.
General	<ul style="list-style-type: none"> • Cut baked goods with filling after heating to release steam and avoid burns. • Stir liquids briskly before and after heating to avoid "eruption". • Use deep bowl, when cooking liquids or cereals, to prevent boilovers. 	<ul style="list-style-type: none"> • Heat or cook in closed glass jars or air tight containers. • Can in the microwave as harmful bacteria may not be destroyed. • Deep fat fry. • Dry wood, gourds, herbs or wet papers.

About utensils and coverings

It is not necessary to buy all new cookware. Many pieces already in your kitchen can be used successfully in your new Microwave Oven. Make sure the utensil does not touch the interior walls during cooking.

Use these utensils for safe microwave cooking and reheating:

- glass ceramic (Pyroceram®), such as Corningware®.
- heat-resistant glass (Pyrex®)
- microwave-safe plastics
- paper plates
- microwave-safe pottery, stoneware and porcelain
- browning dish (Do not exceed recommended preheating time. Follow manufacturer's directions.)

These items can be used for short time reheating of foods that have little fat or sugar in them:

- wood, straw, wicker

DO NOT USE

- metal pans and bakeware
- dishes with metallic trim
- non-heat-resistant glass
- non-microwave-safe plastics (margarine tubs)
- recycled paper products
- brown paper bags
- food storage bags
- metal twist-ties

Should you wish to check if a dish is safe for microwaving, place the empty dish in the oven and microwave on HIGH for 30 seconds. A dish which becomes very hot should not be used.

The following coverings are ideal:

- Paper towels are good for covering foods for reheating and absorbing fat while cooking bacon.
- Wax paper can be used for cooking and reheating.
- Plastic wrap that is specially marked for microwave use can be used for cooking and reheating. DO NOT allow plastic wrap to touch food. Vent so steam can escape.
- Lids that are microwave-safe are a good choice because heat is kept near the food to hasten cooking.
- Oven cooking bags are good for large meats or foods that need tenderizing. DO NOT use metal twist ties. Remember to slit bag so steam can escape.

How to use aluminum foil in your Microwave Oven:

- Small flat pieces of aluminum foil placed smoothly on the food can be used to shield areas that are either defrosting or cooking too quickly.
- Foil should not come closer than one inch to any surface of the oven.

Should you have questions about utensils or coverings, check a good microwave cookbook or follow recipe suggestions.

Accessories

There are many microwave accessories available for purchase. Evaluate carefully before you purchase so that they meet your needs. A microwave-safe thermometer will assist you in determining correct doneness and assure you that foods have been cooked to safe temperatures. Electrolux is not responsible for any damage to the oven when accessories are used.

12 Features

Wave-Touch™ oven features & options

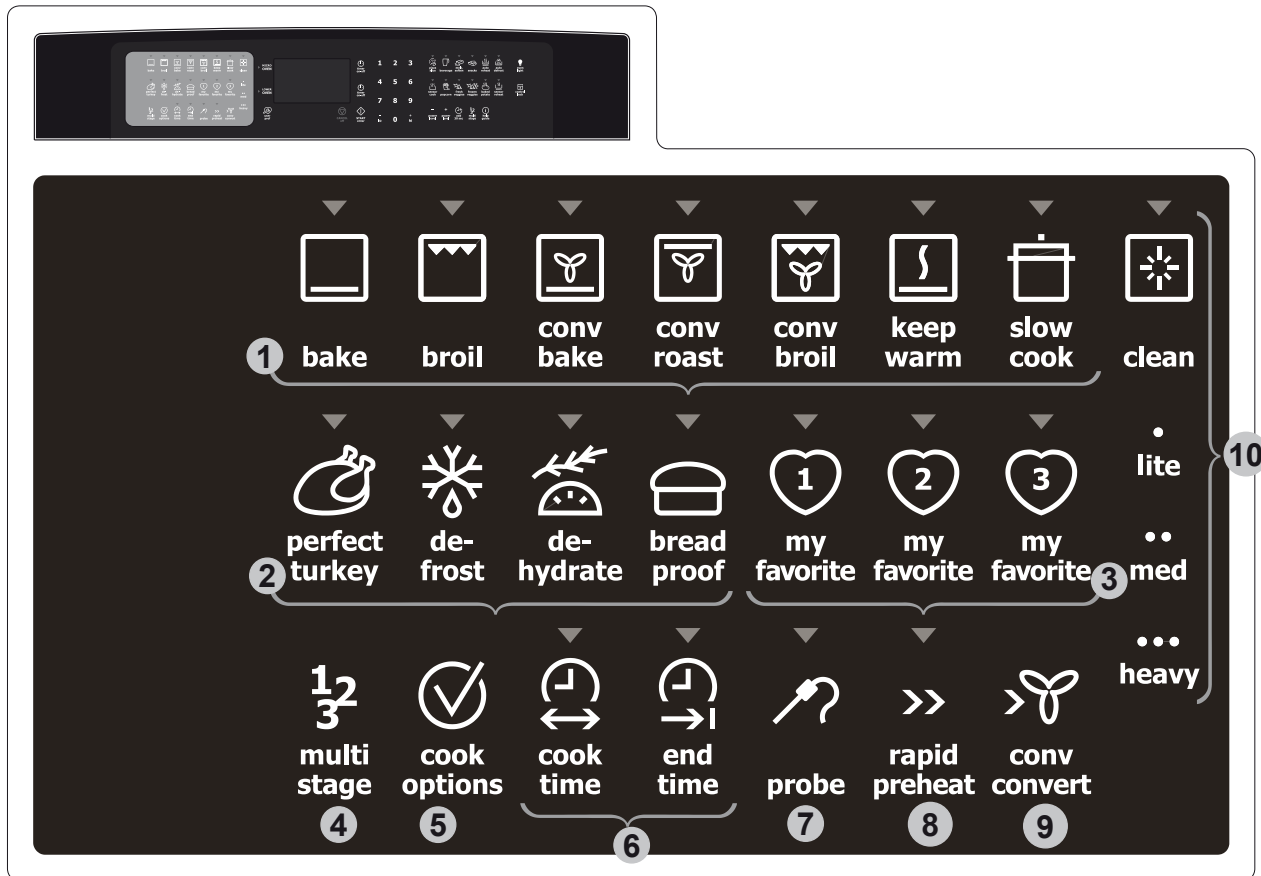

1. Standard cooking
 - Bake
 - Broil
 - Perfect-Convect³™ convection bake
 - Perfect-Convect³™ convection roast
 - Perfect-Convect³™ convection broil
 - Keep warm
 - Slow cook
2. Specialized cooking
 - Perfect Turkey™
 - Defrost
 - Dehydrate
 - Bread proof
3. Favorite settings
4. Perfect Program™ multi stage cooking
5. Cook options
6. Cooking time
 - Cook time
 - End time
7. Probe

8. Rapid preheat
9. Convection convert
10. Cleaning

Minimum & maximum control settings		
Feature	Min. temp	Max. temp
Bake	170°F / 76°C	550°F / 288°C
Bread Proof	85°F / 30°C)	100°F / 38°C
Broil	300°F / 148°C	550°F / 288°C
Conv Bake	170°F / 76°C	550°F / 288°C
Conv Roast	170°F / 76°C	550°F / 288°C
Conv Broil	300°F / 148°C	550°F / 288°C
Keep Warm	150°F/66°C	190°F/88°C
Slow Cook	Lo (225°F / 108°C)	Hi (275°F / 135°C)
Dehydrate	100°F / 38°C	225°F / 108°C
Perfect Turkey	170°F / 76°C	550°F / 288°C

Wave-Touch™ control display & keys

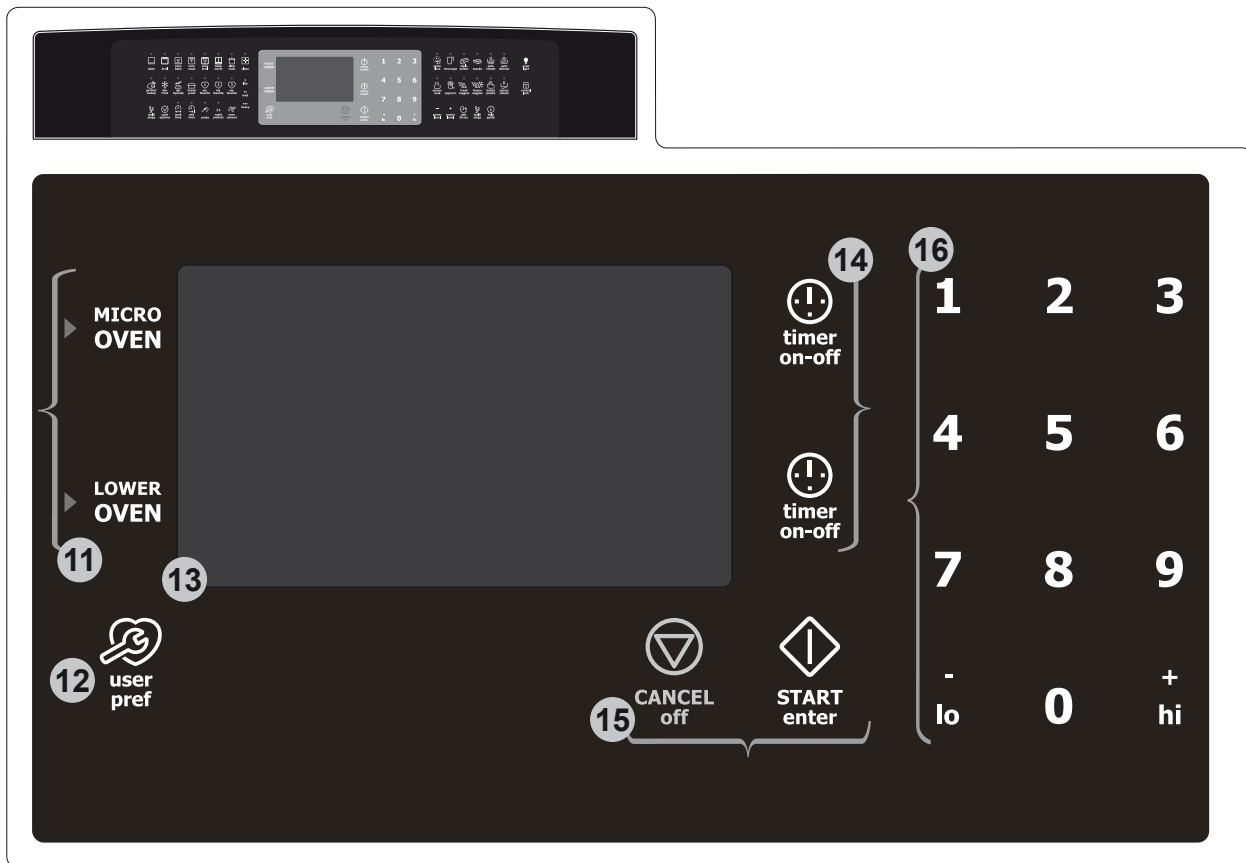

11. Perfect-Pair™ oven key pads

- Microwave upper oven
- Sure-2-fit™ Lower oven

12. User preferences

The following options are available under User Preferences:

- Clock setting
- Clock display setting
- 12 hr/ 24 hr
- Fahrenheit / Celsius
- 12 Hr energy save mode on/off
- Audio mode
- Temperature adjustment (UPO offset)
- Factory default reset

13. Oven display

14. Timers

15. Cancel & Start key pads

16. Numeric key pads

Minimum & maximum time settings		
Feature	Min. time	Max. time
Timer 1	1 min	11 hr 59 min
Timer 2	1 min	11 hr 59 min
Clock 12 hr	1:00 hr	11 hr 59 min
Clock 24 hr	0:00 hr	23 hr 59 min
Cook time 12 hr	1 min	11 hr 59 min
Cook time 24 hr	1 min	11 hr 59 min
End time 12 hr	1:00 hr	12 hr 59 min
End time 24 hr	0:00 hr	23 hr 59 min
Clean duration	Lite (2 hr)	Heavy (4 hr)

Wave-Touch™ microwave oven features & options

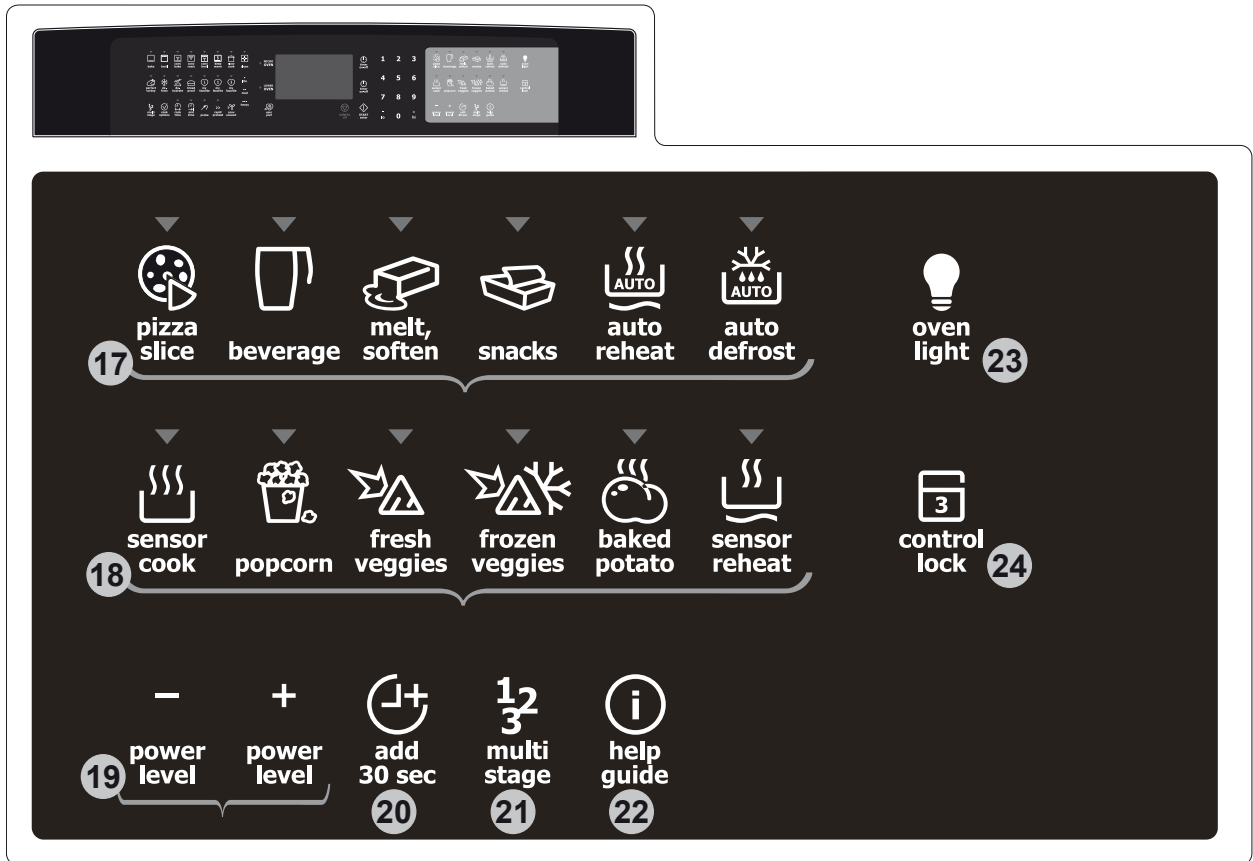

17. Auto cook

- Pizza Slice
- Beverage
- Melt, Soften
- Snacks
- Auto Reheat
- Auto Defrost

18. Sensor Modes

- Sensor Cook
- Popcorn
- Fresh Veggies
- Frozen Veggies
- Baked Potato
- Sensor Reheat

19. Microwave Power

- - Power Level
- + Power Level

20. Add 30 seconds

21. Perfect Program™ multi stage cooking

22. Help Guide

23. Luxury-Lighting™ interior oven lights

24. Control lock

Sensor Cook	Snacks	Auto Reheat
1 Ground Meat	1 Frozen Microwave Pizza	1 Fresh Rolls/Muffins
2 Rice	2 Hand-held Snacks 3-4 oz	2 Frozen Rolls/Muffins
3 Fish / Seafood	3 Hand-held Snacks 5-6 oz	3 Pasta
4 Frozen Entrees	4 Chicken Nuggets	
5 Chicken Breast	5 Frozen Kid's Meal	
	6 Hot Dogs	
Soften, Melt	Defrost	Quick Start
1 Ice Cream	1 Ground Meat	1 1 minutes
2 Cream Cheese	2 Steaks / Chops / Fish	2 2 minutes
3 Butter	3 Chicken Pieces	3 3 minutes
4 Chocolate	4 Roast	4 4 minutes
	5 Casserole	5 5 minutes ...
	6 Soup	9 9 minutes

Wave-Touch™ oven features

Your appliance features include:

1. **Wave-Touch™** activated glass control panel.
One simple touch and the control panel activates, showing the virtually endless cooking options. After you make your choices, all but the option selected will fade away, returning to an elegant display.
2. Stainless steel micro-wave upper oven interior.
Our up to 1.5 cu. ft. large microwaves will hold nearly any dish.
3. Micro-wave oven ventilation.
4. Full-width **Luxury-Hold™** door with tinted window glass.
Our oven door stays put at whatever angle you place it.
5. Large 1-piece metal upper & lower oven door handles.
6. **Sure-2-fit™** cobalt blue self-cleaning lower oven interior with theatre style halogen **Luxury-Design™** lighting system.
Coordinate an entire meal — our oven features 4.2 cu. ft. of cooking space with three adjustable baking racks. Our ramp-up designer halogen lighting is as beautiful as it is functional.
7. **Perfect-Convect^{3®}** convection fan system.
Our convection technology features a third convection element for consistently even results, up to 30% faster cooking times and even more baking options.
8. Extendable **Luxury-Glide®** telescoping interior oven rack(s).
With a ball-bearing system, oven racks are so smooth they extend effortlessly.
9. 1 regular interior oven rack.
10. **Hidden Bake Element.**
The lower bake element is hidden beneath a smooth surface, allowing convenient, easy cleanup.
11. Color coordinated or stainless steel oven exterior panels & trim.
12. Ladder oven rack supports with oven rack sensors.
13. Automatic interior oven door light switch.
14. Self-cleaning lower oven ventilation.
15. Self-clean oven door latch.
16. Microwave popcorn/bacon tray.
17. Removable turntable.
Place the turntable on the turntable support securely. The turntable will rotate clockwise or counterclockwise. Only remove for clearing.
18. Removable turntable support.
Carefully place the turntable support in the center of the oven floor.
19. Convection roasting rack.
20. Broiler pan insert.
21. Broiler pan.

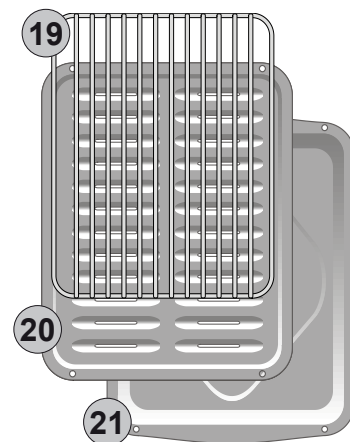
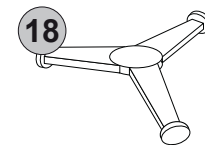
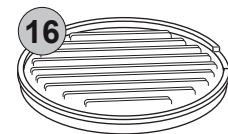
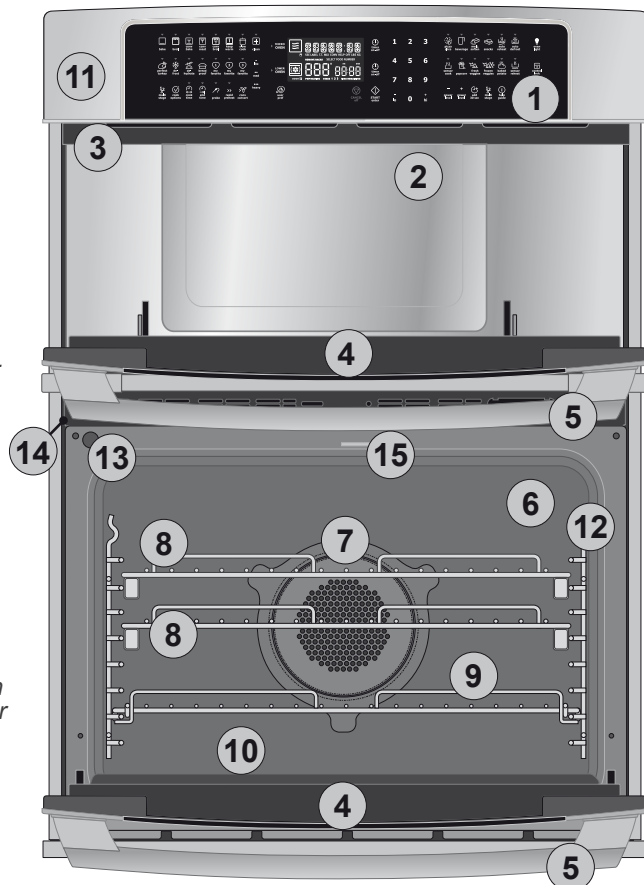

16 Getting Started

Setting clock at power up

You will be prompted to enter the time of day in the event of a **power failure** or when you **first provide electric power** to your appliance.

- When your appliance is first powered up, 12:00 will flash in the display.
- Enter the time of day using the numeric key pads and press **START** to set.

If an invalid time of day is entered, the control will triple beep. Re-enter a valid time of day and press **START**. If **CANCEL** is pressed your clock will start with the time set for **12:00**.

Select the user pref key to modify the time of day during other situations such as day light savings.

Wave-Touch™ display modes

Sleep mode

Your control will remain in a sleep mode when not in use. Only the clock will display during this mode. You will need to wake the control to begin any function.

Awake mode

To awake the control touch within the display panel. If the control panel is not touched again within 2 minutes, the control will return to the sleep mode. To start cooking you must select either the micro oven or the lower oven. User preferences will be available during the awake mode as well as timers, oven light and the control lock.



Timers

The two timers provided with the oven control serve as extra reminders in the kitchen. When a timer reaches less than 1 hour, the display will start to count down in minutes and seconds. When the time runs out the active timer will beep, "0:00" will flash.

The following time settings apply to the timers:

- Min. time: 1 minute
- Max. time: 11 hours 59 minutes

See example below to set the timer for 5 minutes:

Example	
Step	Press
1. Press TIMER	
2. Enter 5 minutes	5
3. Press TIMER	

To cancel after setting the timer, press the **TIMER** key again.

NOTE

The timer(s) will not affect the cooking process.



Fig.1



Fig.2

Changing settings

Software controls the micro and lower ovens so that both may be set to operate at the same time with unique settings. It is very important to understand that before setting or modifying either oven, you must first **select** which oven you desire to set or modify.

The display will provide which oven is currently **selected** for setting/changes by displaying a small red triangle indicator next to the micro or lower oven text.

If the micro oven text symbol displays the red triangle indicator but you wish to set or change the settings for the lower oven, press **LOWER OVEN** once to change the oven selection -Fig. 1-. Then make the setting/changes. You may toggle between either oven and make setting changes at any time except when you are currently setting a cooking mode.

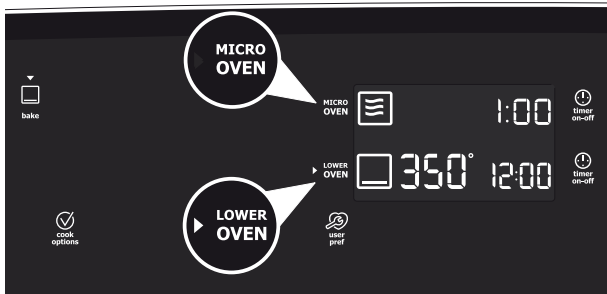

Fig. 1

Preheat Temperature Display

Once a cooking feature has been started in the lower oven, the control will display the actual oven temperature while preheating. Once the oven reaches the oven set temperature only the oven set temperature will display.

The preheat temperature display is available with the following cooking modes:



- Bake
- Conv Bake

Control lock

The control lock will lock both oven controls and the lower oven door.

Control lock is available only in the awake mode.

See example below to lock the ovens.

Example	
Step	Press
To lock, press and hold CONTROL LOCK for 3 seconds.	 3sec
To unlock, press and hold CONTROL LOCK for 3 seconds.	 3sec

DOOR  will flash in the display until the door has finished locking. Once the door has been locked the door lock indicator will turn on. LOCKED will then display.

Do not attempt to open the oven door while the door lock indicator is flashing.

Interior Luxury-Lighting™

Your appliance includes interior oven Luxury-Lighting™ that gradually brightens and dims the lights for the lower oven.

The  key controls the interior lower oven lights.

This model includes 2 halogen lights in the lower oven.

The oven lights will automatically turn ON whenever the lower oven door is opened. The lights will remain on until the door has been shut.

To replace the lower over interior light bulbs see “Changing the oven lights” in the Care and Cleaning section.

18 Setting for Best Results

Lower oven rack supports & oven vents

Installing Oven Rack Supports

CAUTION

Always install oven rack support before turning on the oven (when the oven is cool).

To install oven rack support, insert the supports by pushing them downward into the two brackets on each side of the oven interior, as shown below.

To remove the oven rack support for a self-clean cycle, pull up the support to disengage them from the brackets. If the rack supports are not removed, the self-clean cycle won't start.

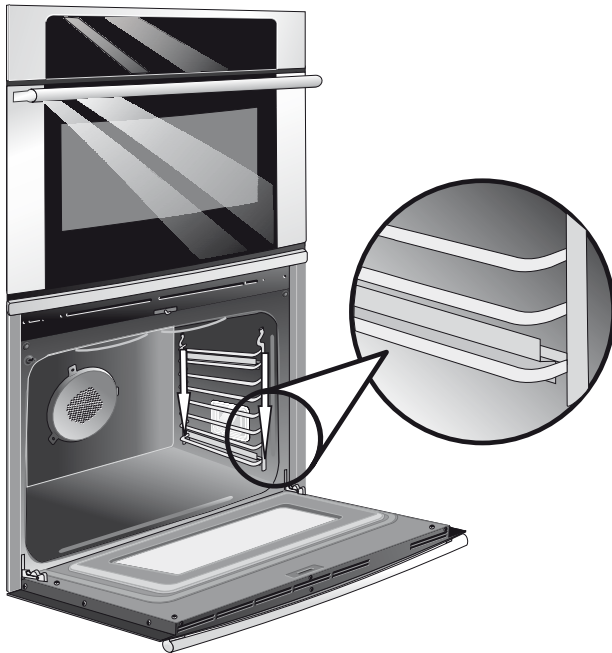

Oven Rack Positions

This oven is equipped with ladder rack supports with 8 positions to accommodate precisely every mode of cooking.

Rack positions

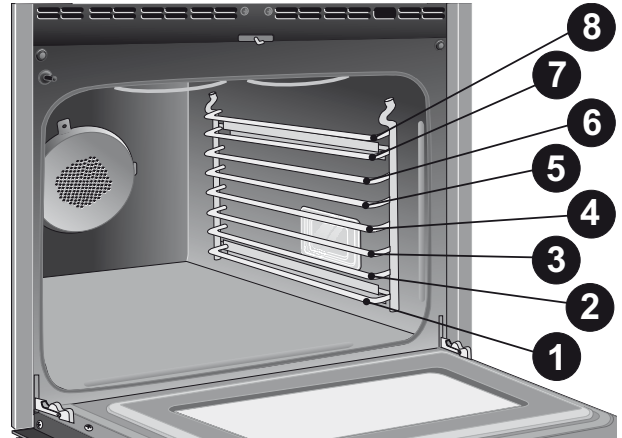

NOTE

Position 1 can only be used with a regular “non-sliding” rack.

Oven Vents Location

The ovens are vented above their door. When the oven is on, warm air is released through the vents. This venting is necessary for proper air circulation in the oven and good baking results.

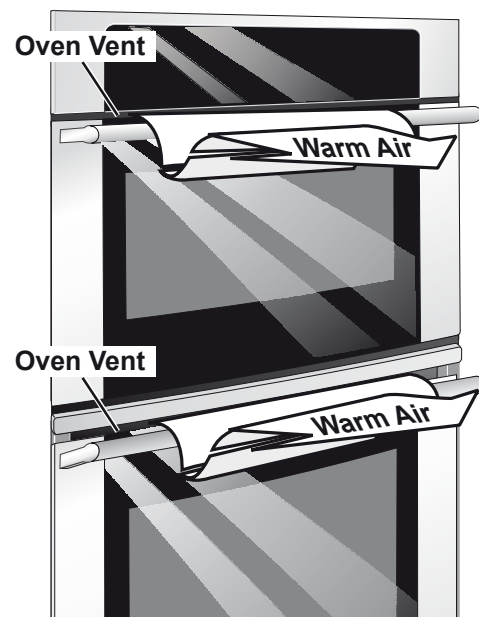

Lower oven racks

Removing Sliding Oven Racks

1. With the rack in its closed position; grasp the rack and the sliders at once.
2. Slightly lift the rack and sliders and pull it to clear the first bracket.
3. Pull the rack and sliders until the second bracket stops the rack.
4. Lift the rack and sliders and carefully remove them from the oven.

Replacing Sliding Oven Racks

To replace the oven racks, follow the instructions above in reverse order.

Refer to the care and cleaning section for directions on how to clean the racks.

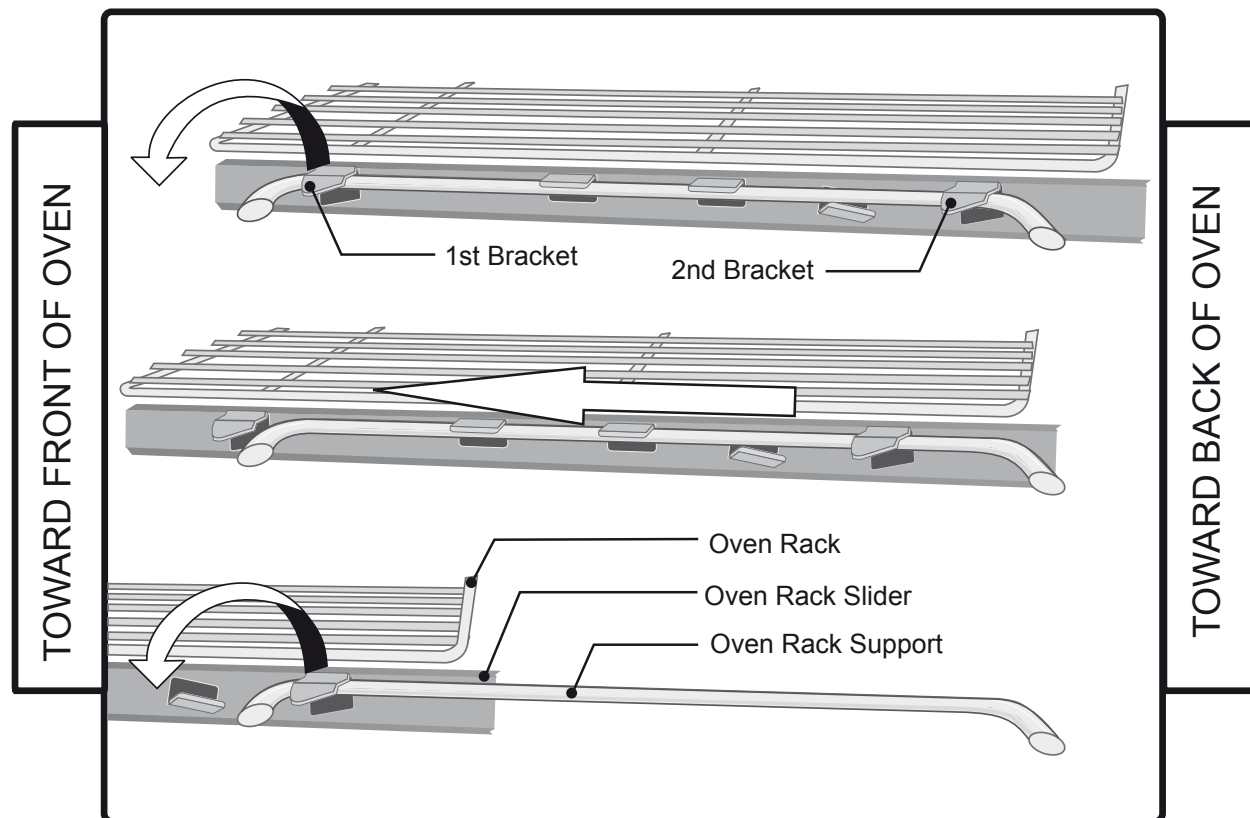

Removing Non-Sliding Oven Racks

Simply pull the rack and slightly tilt it upward when the rack hits its stop position.

Replacing Non-Sliding Oven Racks

Insert the rack into the oven rack supports by inserting the rack openings into the rack supports. Be sure the rack is at the same position on each oven rack support on both sides.

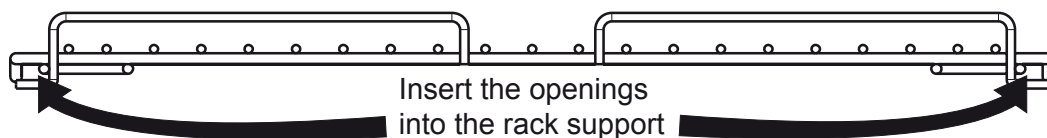

CAUTION

Always arrange the oven racks when the oven is cool (prior to operating the oven).
Always use oven mitts when using the oven.

Time cooking

Your Microwave Oven can be programmed for 99 minutes 59 seconds (99.59). Always enter the seconds after the minutes, even if they are both zeros.

- Suppose you want to cook for 5 minutes at 100%.

Example	
Step	Press
1. Press MICRO OVEN	MICRO OVEN
2. Enter cooking time.	5 0 0
3. Press START	

To set power level

There are ten preset power levels.

Using lower power levels increases the cooking time which is recommended for foods such as cheese, milk and long slow cooking of meats. Consult cookbook or recipes for specific recommendations.

Numeric pad	Power level	Common words for power levels
0	100	High
9	90	
8	80	
7	70	Medium High
6	60	
5	50	Medium
4	40	
3	30	Med Low/ Defrost
2	20	
1	10	Low

Power level can be set by using the **power level +** or **-**. You can also press the corresponding numeric pad after pressing either **power level +** or **-**.

- Suppose you want to defrost for 5 minutes at 30%.

Example	
Step	Press
1. Press MICRO OVEN	MICRO OVEN
2. Enter defrosting time.	5 0 0
3. Press power level - or + .	- or + power level OR power level
4. Press the numeric pad 3 to select power level 30.	3
5. Press START	

Manual defrost

If the food that you wish to defrost is not listed on the Auto Defrost chart or is above or below the limits in the "Amount" column on the Defrost chart, you need to defrost manually.

You can defrost any frozen food, either raw or previously cooked, by using Power level 30. Follow the exact procedure found under Time cooking. Estimate defrosting time and lower your power level to 30%.

For either raw or previously cooked frozen food the rule of thumb is approximately 5 minutes per pound. For example, defrost 5 minutes for 1 pound of frozen spaghetti sauce.

Always stop the oven periodically to remove or separate the portions that are defrosted. If food is not defrosted at the end of the estimated defrosting time, program the oven in 1 minute increments on power level 30 until totally defrosted.

When using plastic containers from the freezer, defrost only long enough to remove from the plastic in order to place in a microwave-safe dish.

Sensor Modes

The sensor is a semi-conductor device that detects the vapor (moisture and humidity) emitted from the food as it heats. The sensor adjusts the cooking times and power level for various foods and quantities.

Using Sensor Modes:

1. After oven is plugged in, wait 2 minutes before using Sensor Modes.
2. Be sure the exterior of the cooking container and the interior of the oven are dry. Wipe off any moisture with a dry cloth or paper towel.
3. The oven works with foods at normal storage temperature. For example, popcorn would be at room temperature.
4. Any Sensor Modes selection can be programmed with More or less time adjustment.
5. More or less food than the quantity listed in the chart should be cooked following the guidelines in any microwave cookbook.
6. During the first part of any sensor cooking or reheating, *SENSING* will appear on the display. Do not open the oven door during this part of the cycle. The measurement of vapor will be interrupted. If this occurs, an error message will appear. To continue cooking, press the **CANCEL/off** pad and cook manually.
When the sensor detects the vapor emitted from the food, remainder of cooking time will appear. Door may be opened when remaining cooking time appears on the display. At this time, you may stir or season food, as desired.
7. Except for popcorn, if the sensor does not detect vapor properly when cooking other foods, *ERROR* will be displayed.
8. Check food for temperature after cooking. If additional time is needed, continue to cook manually.
9. Each food has a cooking hint. Touch **help guide** pad when the *HELP* indicator is lighted in the display.

Covering Foods:

Some foods cook better when covered. Use the cover recommended in the food charts.

1. Casserole lid.
2. Plastic wrap: Use plastic wrap recommended for microwave cooking. Cover dish loosely; allow approximately 1/2 inch to remain uncovered to

allow steam to escape. Plastic wrap should not touch food.



3. Wax paper: Cover dish completely; fold excess wrap under dish to secure. If dish is wider than paper, overlap two pieces at least one inch to cover.

Be careful when removing any covering to allow steam to escape away from you.

Quick Sensor

You can cook or reheat many foods by touching a Quick Sensor pad (**fresh veggies, frozen veggies, popcorn, baked potato and sensor reheat**). You don't need to calculate cooking time or power level.

- Suppose you want to pop a 3.5 oz. bag of popcorn.

Example	
Step	Press
Use the popcorn/bacon tray provided with your unit to cook popcorn quickly and efficiently.	
1. Press MICRO OVEN .	
2. Press popcorn .	
3. Press 2 for regular size.	
4. Press START	

WARNING

Do not place microwave popcorn directly on the metal turntable as metal on metal may produce sparking. Always use the popcorn/bacon tray provided with the unit to cook popcorn.

NOTES

1. Quick Sensor can be programmed with More or less time adjustment.
2. The final result will vary according to the food condition (e.g. initial temperature, shape, quality). Check food for temperature after heating. If additional time is needed, continue to heat manually.





Quick Sensor chart

Food	Amount	Procedure
Fresh Veggies:		Wash and place in casserole. Add no water if vegetables have just been washed. Cover with lid for tender vegetables. Use plastic wrap for tender-crisp vegetables. Touch fresh veggies pad. Select 1 for soft veggies. After cooking, stir, if possible. Let stand, covered, for 2 to 5 minutes.
Soft		
Broccoli	0.25 - 2.0 lb	
Brussels sprouts	0.25 - 2.0 lb	
Cabbage	0.25 - 2.0 lb	
Cauliflower (flowerets)	0.25 - 2.0 lb	
Cauliflower (whole)	1 medium	
Spinach	0.25 - 1.0 lb	
Zucchini	0.25 - 2.0 lb	
Baked apples	2 - 4 medium	
Hard		
Carrots, sliced	0.25 - 2.0 lb	
Corn on cob	2 - 4 pcs.	
Green beans	0.25 - 2.0 lb	
Winter squash		
- diced	0.25 - 2.0 lb	
- halves	1 - 2	
Frozen Veggies	0.25 - 1.25 lb	Add no water. Cover with lid or plastic wrap. After cooking, stir and let stand, covered, for 3 minutes.
Popcorn	Regular 3.0 - 3.5 oz bag	Use only popcorn packaged for the microwave. Try several brands to decide which you like. Do not try to pop unpopped kernels. Use the popcorn/bacon tray provided with your unit to cook popcorn quickly and efficiently. Select 1 for snack size and 2 for regular size. This sensor works well with most brands of microwave popcorn. You may wish to try several and choose your favorite. Pop only one bag at a time. Unfold the bag and place in oven according to directions.
	Snack 1.5- 1.75 oz bag	
Baked Potato	1 - 8 med.	Pierce with fork in several places. Place on paper towel on turntable. After cooking, remove from oven and let stand wrapped in foil for 5 to 10 minutes.
Sensor Reheat	4 - 36 oz	Place in dish or casserole slightly larger than amount to be reheated. Flatten, if possible. Cover with lid, plastic wrap or wax paper. Use covers such as plastic wrap or lids with larger quantities of more dense foods such as stews. After reheating, stir well, if possible. Re-cover and allow to stand 2 to 3 minutes. Foods should be very hot. If not, continue to heat with variable power and time.

Sensor Cook

You can cook many foods by touching the **sensor cook** pad and the food number. You don't need to calculate cooking time or power level.

- Suppose you want to cook ground meat.

Example	
Step	Press
1. Press MICRO OVEN	
2. Press sensor cook	
3. Press 1 for ground meat	
4. Press START	

NOTES

1. Sensor Cook can be programmed with More or less time adjustment.
2. The final result will vary according to the food condition (e.g. initial temperature, shape, quality). Check food for temperature after heating. If additional time is needed, continue to heat manually.
3. Stay near the oven while it's in use and check cooking progress frequently so that there is no chance of overcooking food.



Sensor Cook chart

Food	Amount	Procedure															
1. Ground Meat	0.25 - 2.0 lb	Use this setting to cook ground beef or turkey as patties or in a casserole to be added to other ingredients. Place patties on a microwave-safe rack and cover with wax paper. Place ground meat in a casserole and cover with wax paper or plastic wrap. After cooking, let stand, covered, for 2 to 3 minutes.															
2. Rice	0.5 - 2.0 cups	Place rice into a deep casserole dish and add double quantity of water. Cover with lid or plastic wrap. After cooking, stir, cover and let stand 3 to 5 minutes or until all liquid has been absorbed. <table border="1" data-bbox="600 1312 1318 1480"> <thead> <tr> <th>Rice</th> <th>Water</th> <th>Size of casserole dish</th> </tr> </thead> <tbody> <tr> <td>.5 cup</td> <td>1 cup</td> <td>1.5 quart</td> </tr> <tr> <td>1 cup</td> <td>2 cups</td> <td>2 quart</td> </tr> <tr> <td>1.5 cups</td> <td>3 cups</td> <td>2.5 or 3 quart</td> </tr> <tr> <td>2 cups</td> <td>4 cups</td> <td>3 quart or larger</td> </tr> </tbody> </table>	Rice	Water	Size of casserole dish	.5 cup	1 cup	1.5 quart	1 cup	2 cups	2 quart	1.5 cups	3 cups	2.5 or 3 quart	2 cups	4 cups	3 quart or larger
Rice	Water	Size of casserole dish															
.5 cup	1 cup	1.5 quart															
1 cup	2 cups	2 quart															
1.5 cups	3 cups	2.5 or 3 quart															
2 cups	4 cups	3 quart or larger															
3. Fish/Seafood	0.25 - 2.0 lb	Arrange in ring around shallow glass dish (roll fillet with edges underneath). Cover with plastic wrap. After cooking, let stand, covered, 3 minutes.															
4. Frozen Entrees	6 - 17 oz	Use this pad for frozen, convenience foods. It will give satisfactory results for most brands. You may wish to try several and choose your favorite. Remove package from outer wrapping and follow package directions for covering. After cooking, let stand, covered for 1 to 3 minutes.															
5. Chicken Breast	0.5 - 2.0 lb	Cover with vented plastic wrap. After cooking, let stand, covered 3 to 5 minutes. Chicken should be 160°F.															

Auto Cook

Your oven has convenient pads to assist with meal preparation. The Auto Cook settings will automatically compute the correct cooking time and microwave power level for foods shown in the following charts.

- Suppose you want to heat 1 cup of water

Example	
Step	Press
1. Press MICRO OVEN	
2. Press beverage	
3. Enter cups by touching the number pads 1 and 0.	10
4. Press START	

NOTES

1. All Auto Cook settings can be programmed with More or Less time adjustment. Touch the **power level** pad once or twice before touching **START** pad. See More or less adjustment.
2. Most food has a cooking hint. Touch **help guide** pad when it is lighted in the display.
3. Should you attempt to enter more or less than the allowed amount, an error beep will sound.

More or less than the quantity listed in the chart should be cooked following the guidelines in any microwave cookbook.

4. The final cooking result will vary according to the food condition (e.g. initial temperature, shape, quality). Check food for temperature after cooking. If additional time is needed, continue to cook manually.

Auto Cook chart

Food	Amount	Default	Procedure
1. Pizza	1 - 6 slices (6 - 8 oz)	1 slice	Use this setting to reheat refrigerated leftover pizza, 1 slice is approximately 1/8th of a 12-inch pizza or 1/12th of a 16-inch pizza. If possible, place on paper towel on a microwave-safe rack. Touch pizza pad, enter number of slices, and touch START .
2. Beverage	0.5 - 2.0 cups	1 cup	This setting is good for restoring a cool beverage to a better drinking temperature. Stir liquid briskly before and after heating to avoid "eruption". The beverage setting must be entered in 0.1 cup measurements.





Auto Cook chart (cont.)

Food	Amount	Default	Procedure
Snacks			
1. Microwave Pizza	1 (6 - 8 oz)	N/A	Use for frozen microwave pizza. Remove from package and unwrap. Follow package directions for use of package and/or silver crisping disc. Touch snacks pad and the number 1. Touch START .
2. Hand-held Snacks	3 - 4 oz	N/A	Use for frozen French fries, cheese sticks, appetizers etc. Remove from outer package. Follow package directions for how to wrap or cover. Be careful when removing from the oven as snack may be very hot. Touch snacks pad and the number 2. Touch START .
3. Hand-held Snacks	5 - 6 oz	N/A	Use for frozen French fries, cheese sticks, appetizers etc. Remove from outer package. Follow package directions for how to wrap or cover. Be careful when removing from the oven as snack may be very hot. Touch snacks pad and the number 3. Touch START .
4. Chicken Nuggets	0.3 - 1.0 lb	0.4 lb	Place frozen chicken nuggets on a flat plate allowing space between each, cover food with paper towel. Touch snacks pad and the number 4. Enter weight and touch START . After cooking, open door, rearrange, close door and touch START . Let stand, covered, for 1 to 3 minutes.
5. Frozen Kid's Meal	6 - 8 oz	N/A	Use this pad for frozen, convenience foods. It will give satisfactory results for most brands. You may wish to try several and choose your favorite. Remove package from outer wrapping and follow package directions for covering. Touch snacks pad and the number 5. Touch START . After cooking, let stand, covered for 1 to 3 minutes.
6. Hot Dogs	1 - 6	1	Place hot dog in bun. Wrap each with paper towel or napkin. Touch snacks pad and the number 6. Enter the quantity of hot dogs and touch START .

Auto Reheat

The reheat settings automatically computes the correct warming and heating time and microwave power level for foods shown in the chart below.

- Suppose you want to heat 2 fresh rolls or muffins.

Example	
Step	Press
1. Press MICRO OVEN	
2. Press auto reheat .	
3. Press number 1 for fresh rolls or muffins.	1
4. Press START	
5. Select desired number to select quantity.	2
6. Press START	

NOTES

1. To reheat different foods or foods above or below the quantity allowed, use manual operation.
2. Reheat settings can be programmed with More or less time adjustment.





Auto Reheat chart

Food	Amount	Default	Procedure
1. Fresh Rolls/ Muffins	1 - 10	1	Use this pad to warm rolls, muffins, biscuits, bagels etc. Large items should be considered as 2 or 3 regular size. Arrange on plate; cover with paper towel. For refrigerated rolls or muffins, it may be necessary to double the entered amount to ensure the proper serving temperature. For example, enter quantity of 2 for 1 refrigerated muffin. Touch desired number to select quantity and touch START .
2. Frozen Rolls/ Muffins	1 - 10	1	Use this pad to warm frozen rolls, muffins, biscuits, bagels, etc. Large items should be considered as 2 or 3 regular size. Arrange on plate, cover with paper towel. Touch desired number to select quantity and touch START .
3. Pasta	1 - 6 cups	1 cup	Use this pad to reheat refrigerated canned or homemade pasta with sauce. For room temperature pastas, use Less option. Pasta without sauce double the quantity per setting. For example, measure 2 cups of cooked noodles and program for 1 cup. Cover with lid or plastic wrap. Touch auto reheat pad and touch number 3. Enter the desired number of cups and touch START . After cooking, let stand, covered, 2 to 3 minutes.

Melt, Soften

Melt, soften automatically compute the correct heating time and microwave power level for softening and melting foods shown in the chart.

- Suppose you want to melt 1 square of chocolate.

Example	
Step	Press
1. Press MICRO OVEN	
2. Press melt, soften pad.	
3. Select desired food by pressing number pad. Ex: Press number 4 for chocolate.	4
4. Press START	
5. Press number 2 pad to select 1 square.	2
6. Press START	

NOTES

1. To soften or melt other food or foods except the quantity listed in the Quick settings Chart, use manual operation.
2. Quick Settings can be programmed with More or less time adjustment.





Melt, Soften chart

Food	Amount	Default	Procedure
Melt, Soften			DO NOT COVER.
1. Ice Cream	1 pint	1 pint	Press Melt, Soften , press 1 for ice cream, press START , press 1 for one pint.
	1/2 gallon		Press Melt, Soften , press 1 for ice cream, press START , press 2 for half a gallon.
2. Cream Cheese	3 oz	3 oz	Press Melt, Soften , press 2 for cream cheese, press START , press 1 for 3 oz.
	8 oz		Press Melt, Soften , press 2 for cream cheese, press START , press 2 for 8 oz.
3. Butter	2 tbsp	2 tbsp	Use a Pyrex measuring cup. Cover with plastic wrap. Press Melt, Soften , press 3 for butter, press START , press 1 for 2 tbsp.
	1/2 cup		Press Melt, Soften , press 3 for butter, press START , press 2 for 1/2 cup.
4. Chocolate	1 cup chips	1 cup chips	Press Melt, Soften , press 4 for chocolate, press START , press 1 for 1 cup of chips.
	1 square		Press Melt, Soften , press 4 for chocolate, press START , press 2 for 1 square.

Auto Defrost

Auto Defrost automatically defrosts all the foods found in the Auto Defrost chart below.

- Suppose you want to defrost a 2.0 pound steak.

Example	
Step	Press
1. Press MICRO OVEN	
2. Press auto defrost pad.	
3. Press number 2 for steak.	2
4. Press START .	
5. Enter weight by touching the number pads 2 and 0. Ex: 2.0 lb steak.	20
6. Press START .	
7. The oven will stop so the food can be checked. Open the door. Turn steak over and shield any warm portions. Close the door. Press START pad.	

After defrost cycle ends, let stand, covered.

NOTES

1. To defrost other food or foods above or below the weights allowed on the Defrost chart, use time and 30% power. See Manual defrost.
2. Auto Defrost can be programmed with More or less time adjustment. Touch the **power level +** or **-** pad once or twice before touching **START** pad.
3. Touch **help guide** pad when it is lighted in the display for a helpful hint.
4. Should you attempt to enter more or less than the amount as indicated in the chart below, an error beep will sound.
5. Check foods when oven signals. After final stage, small sections may still be icy. Let stand to continue thawing. Do not defrost until all ice crystals are thawed.
6. Shielding prevents cooking from occurring before the center of the food is defrosted. Use small smooth strips of aluminum foil to cover edges and thinner sections of the food.

Auto Defrost chart



Food	Amount	Default	Procedure
1. Ground Meat	0.5 - 3.0 lb	0.5 lb	Remove any thawed pieces after each stage. Let stand, covered, for 5 to 10 minutes.
2. Steaks/Chops/ Fish	0.5 - 4.0 lb	0.5 lb	After each stage, rearrange and if there are warm or thawed portions, shield with small flat pieces of aluminum foil. Remove any meat or fish that is almost defrosted. Let stand, covered, for 10 to 20 minutes.
3. Chicken Pieces	0.5 - 3.0 lb	0.5 lb	After each stage, rearrange pieces or remove portions should they become warm or thawed. Let stand, covered, for 10 to 20 minutes.
4. Roast	2.0 - 4.0 lb	2.0 lb	Start defrosting with fat side down. After each stage, turn roast over and shield the warm portions with aluminum foil. Let stand, covered, for 30 to 60 minutes.
5. Casserole	2 - 6 cups	2 cups	After audible signal, stir if possible. At end, stir well and let stand, covered, for 5 to 10 minutes.
6. Soup	1 - 6 cups	1 cup	After audible signal, stir if possible. At end, stir well and let stand, covered, for 5 to 10 minutes.

Multi Stage cooking

Your oven can be programmed for up to 3 automatic cooking sequences, switching from one power level setting to another automatically.

Sometimes cooking directions tell you to start on one power level and then change to a different power level. Your oven can do this automatically.

- Suppose you want to cook roast beef for 5 minutes at 100% and then continue to cook for 30 minutes at 50%.

Example	
Step	Press
1. Press MICRO OVEN .	MICRO OVEN
2. Press multi stage .	1 2 3
3. Enter cooking time for first stage.	5 0 0
4. Press power level + to get to 100.	+ power level
5. Press START to confirm first stage.	
6. Enter cooking time for second stage.	3 0 0 0
7. Press power level + or - until you get to 50.	- + power level power level
8. Press START to confirm second stage.	
9. Press START a third time to confirm that you do not want a third stage*.	

* You can program a third stage at this step.

More or less time adjustment

Should you discover that you like any of the Sensor Modes, Auto Cook, Quick Settings, Auto Reheat or Auto Defrost slightly more done, touch the **power level +** pad after touching your choice of pads or before touching **START** pad. The display will show **MORE**.

Should you discover that you like any of the Sensor Modes, Auto Cooks, Quick Settings, Auto Reheat or Auto Defrost slightly less done, touch the **power level -** pad after touching your choice of pads or before touching **START** pad. The display will show **LESS**.

Quick Start

quick start is a short-cut method to set time for 1-9 minutes at power level 100.

- Suppose you want to heat a cup of soup for two minutes.

Example	
Step	Press
Press number 2 pad and wait for 4 seconds.	2

The oven will start after 5 seconds and will signal then turn off automatically when finished.

Add 30 Seconds

add 30 seconds provides a convenient way to extend cooking time by 30 seconds while the oven timer is counting down. It will add 30 seconds to the time shown each time the pad is touched.

This pad may also be used as a quick start for 30 seconds of cooking. No need to touch **START**, the oven will start immediately.

Help Guide

Most setting has a cooking hint. If you wish to check, touch **help guide** whenever the pad is lighted in the Interactive Display for these and other manual operation hints.

About rapid preheat

Use the rapid preheat option on **single rack baking** to quickly bring the lower oven to baking temperature.

The rapid preheat option may be set with the following cooking features:





- Bake
- Conv bake

The following temperature settings apply to the rapid preheat feature:

- Auto-suggest (default) setting: **350°F/176°C**
- Min. rapid preheat setting: **170°F / 76°C**
- Max. rapid preheat setting: **550°F / 288°C**

Setting rapid preheat

See example below to set a rapid preheat with bake to start immediately using default temperature.

Example	
Step	Press
1. Press LOWER OVEN	LOWER OVEN
2. Press BAKE	
3. Press COOK OPTIONS	
4. Press RAPID PREHEAT	
5. Press START	

When **START** is pressed the oven will preheat quickly. The control will display **PRE-HEATING** during this time. While **PREHEATING** the Convection fan may operate.

After a few minutes a beep will sound and **PRE-HEATING** will no longer display. Place prepared food on a single oven rack. The oven will continue to bake at the set temperature until bake is canceled.

NOTE

You may press **CANCEL** at any time when setting the control or during the cooking process.

To add or change any cook settings after this feature has started:

- Select the **LOWER** oven. Make temperature changes using the **+** or **-** keys. Each press of **+** or **-** will adjust the temperature by 5° F (or 2°C).
- If changing cooking times, select the **cook time** or **end time** keys needed to make the changes.



For best results

- **Single oven rack cooking ONLY.**
- Use in oven rack positions 2 or 3.

About baking in lower oven

Use the bake feature to cook most food items that require normal cooking temperatures.

Bake may be set with the following options:



- Rapid preheat
- Cook time
- Cook time with end time
- Probe

The following temperature settings apply to the bake feature:

- Auto-suggest (default) setting: **350°F/176°C**
- Min. bake setting: **170°F / 77°C**
- Max. bake setting: **550°F / 288°C**

Setting bake for lower oven

See example below to set a bake to start immediately using the default temperature.

Example	
Step	Press
1. Press LOWER OVEN	LOWER OVEN
2. Press BAKE	
3. Press START	

Once **START** is pressed the oven will begin heating. The oven display shows **PRE-HEATING**. While **PREHEATING** the Convection fan may operate.

After the oven reaches set temperature, **PRE-HEATING** will turn off and a beep will indicate the oven is ready. The oven will continue to maintain this temperature until the cooking feature is canceled.

NOTE

You may press **CANCEL** any time when setting the control or during the cooking process.

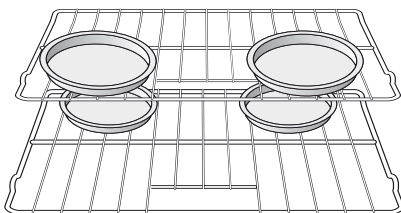

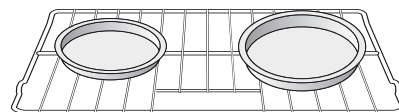

Pan position for two rack baking.



Pan position for one rack baking.

If your recipe requires a different baking temperature than the auto-suggested (default) temperature (example below shows lower oven temperature set for 425°F/ 218°C) :

Example	
Step	Press
1. Press LOWER OVEN	LOWER OVEN
2. Press BAKE	
3. Enter 425°F	425
4. Press START	

To add or change any cook settings after this feature has started:

- Select the **LOWER OVEN**. Make temperature changes using the **+** or **-** keys. Each press of **+** or **-** will adjust the temperature by 5° F (or 2°C). It is also possible to press **LOWER OVEN, BAKE**, use the numeric pads and confirm with **START**.
- If changing cooking times, select the **cook time** or **end time** keys needed to make the changes.



For best results

- Use only one rack at position 5 and center the pans as much as possible.
- If using two racks, place the oven racks in position 3 and 7.
- When placing multiple food items in the oven allow 2-4" (5-10cm) of space between the food items for proper air circulation (see figures for more details).
- Dark or dull pans absorb more heat than shiny bakeware resulting in dark or overbrowning of foods. It may be necessary to reduce the oven temperature or cook time to prevent overbrowning of some foods. Dark pans are recommended for pies. Shiny pans are recommended for cakes, cookies and muffins.

32 Setting Lower Oven Controls

Using cook time in lower oven

Adding a cook time when baking is beneficial when a recipe requires a specific temperature and period of time to cook. Following the recipe cook time helps insure the best possible results.





Cook time may be set with the following features:

- Bake
- Conv bake
- Conv roast
- Slow cook
- Defrost
- Dehydrate
- Bread proof
- Keep warm

NOTE

- You may press CANCEL any time when setting the control or during the cooking process.

See example below to set the lower oven for bake, starting immediately with preheating to the auto-suggest (default) setting of 350°F (176°C) and then to automatically turn off after 30 minutes:

Example	
Step	Press
Preheat the oven if necessary	
1. Press LOWER OVEN	LOWER OVEN
2. Press BAKE	
3. Press START	
4. Press COOK OPTIONS	
5. Press COOK TIME	
6. Enter 30 minutes	30
7. Press START	

Once START is pressed the oven will cook and after 30 minutes automatically shut-off.

Using cook time with end time in lower oven

Adding a cook time along with a specific end time gives the same benefits as the cook time option in addition to controlling exactly when the cooking process will begin and end.







Cook time and end time may be set with the following features:

- Bake
- Convection bake
- Convection roast
- Slow cook
- Clean (delayed Clean uses end time only)
- Defrost
- Dehydrate
- Bread proof
- Keep warm

NOTE

- When setting the END TIME option be sure the correct time of day is set.
- You may press CANCEL any time when setting the control or during the cooking process.
- You may also choose to use **COOK TIME** with no **END TIME**.

See example below to set the lower oven with pre-heating for bake at 375°F (176°C) for 50 minutes and to automatically shut-off at 5:30:

Example	
Step	Press
1. Press LOWER OVEN	LOWER OVEN
2. Press BAKE	
3. Enter 375°F	375
4. Press COOK OPTIONS	
5. Press COOK TIME	
6. Enter 50 minutes	50
7. Press START	
8. Press END TIME	
9. Enter 5:30	530
10. Press START	

Once **START** is pressed, the oven will calculate the start time at which the oven will begin heating.

The oven will continue to maintain this temperature for the selected time or until the cooking feature is canceled.

34 Setting Lower Oven Controls

Broiling in lower oven

Use the **broil** feature to cook meats that require direct exposure to radiant heat for optimum browning results.

Use the **conv broil** feature to cook thicker cuts of meats that require direct exposure to radiant heat and the convection fan for optimum browning results.

The following temperature settings apply to the broil feature:

- Auto-suggest (default) setting: **550°F / 288°C**
- Min. broil setting: **300°F / 148°C**
- Max. broil setting: **550°F / 288°C**

WARNING

Should an oven fire occur, close the oven door. If the fire continues, throw baking soda on the fire or use a fire extinguisher. **Do not** put water or flour on the fire. Flour may be explosive and water can cause a grease fire to spread and cause personal injury.

CAUTION



- **Do not** use the broiler pan without the insert.
- **Do not** cover the broil pan/insert with aluminum foil; the exposed grease could ignite.
- To prevent food from contacting the broil element and to prevent grease splattering, **do not** use the roasting rack when broiling.

For best results

- Use the recommended pans and oven rack positions for the type of meat being prepared -*Figs. 2 & 3-*.
- For optimum browning results, allow the oven to preheat **5-6 minutes** before placing the food in the oven.

Setting broil

See example below to set broil for the lower oven starting immediately with the auto-suggest (default) setting:

Example	
Step	Press
1. Place the broiler insert on the broiler pan, then place the meat on the insert. Remember to follow all warnings and cautions.	
2. Arrange the interior oven rack to rack position recommendations - <i>Figs. 2 & 3-</i> . Be sure to place the prepared food and pan directly under broil element. Leave the oven door closed.	
3. Press LOWER OVEN	
4. Press BROIL	
5. Press START	

NOTE

You may press CANCEL any time while setting the control or during the broiling process.

To add or change any cook settings after this feature has started:

- Wake control panel from the sleep mode if necessary.
- Select the **LOWER**. Make temperature changes using the **+** or **-** keys. Each press of **+** or **-** will adjust the temperature by 5° F (or 2°C).

NOTE

Leaving open the lower oven door for a minute while broiling will cause the electronic controls to prompt “dr” to remind you to close the door. If the oven door is not closed after 30 seconds, the controller will cancel the broiling and return to an “awake” mode.

Setting broil

The broil pan insert (if equipped) contains slots that allows grease from the meat to drain into the broil pan. Place prepared meat on broil pan insert and then place onto broiler pan as shown -Fig. 1-.

Recommended broiling times

Use the broiling table -Fig. 3- for approximate recommended broiling times for the types of meats listed. Increase or decrease broiling times, or move the broiling pan to a different rack position to suit for doneness.

If the food you are broiling is not listed in the table, follow the instructions provided in your recipe and watch the item closely.

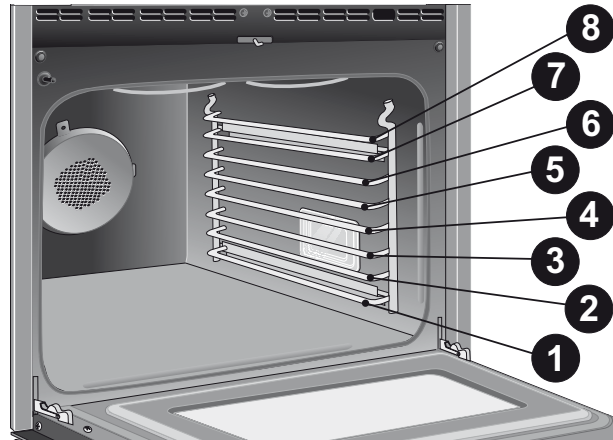

Fig. 2

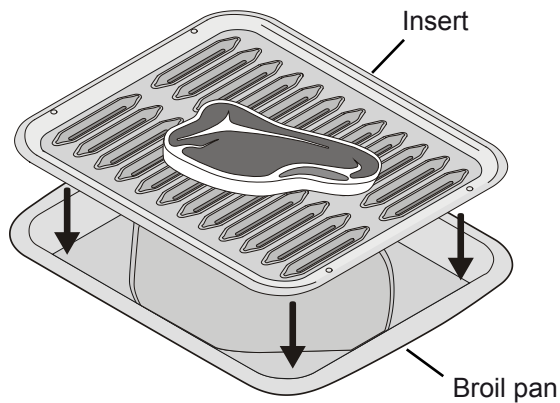

Fig. 1

Broiling Table					
Food	Rack position	Temp	Cook time in minutes		Doneness
			1st side	2nd side	
Steak 1" thick	7th	550°F	6	4	Rare
	7th	550°F	7	5	Medium
	7th	550°F	8	7	Well
Pork chops 3/4" thick	7th	550°F	8	6	Well
Chicken-bone in	5th	450°F	20	10	Well
Chicken-boneless	7th	450°F	8	6	Well
Fish	7th	500°F	13	0	Well
Shrimp	5th	550°F	5	0	Well
Hamburger 1" thick	7th	550°F	9	7	Medium
	5th	550°F	10	8	Well

Fig. 3

About convection bake

Convection bake is part of the Perfect-Convect³™ system. Convection bake uses a fan to circulate the oven heat evenly and continuously. The improved heat distribution allows for even cooking with excellent results. Multiple rack cooking may slightly increase cook times for some foods, but the overall result is time saved.

The conv bake feature should **ONLY** be used when your recipe instructions have been written for use with convection baking.

If your recipe instructions are for normal baking and you wish to use convection bake, follow the **Convection Convert** option instructions. The convection convert option will automatically adjust the oven temperature so that convection baking may provide the best possible results.

Conv bake may be set with the following options:

- Conv convert
- Cook time or cook time with end time
- Probe
- Rapid preheat

Benefits of convection bake:

- Superior multiple oven rack performance.
- Some foods cook up 25 to 30% faster, saving time and energy.
- No special pans or bakeware required.

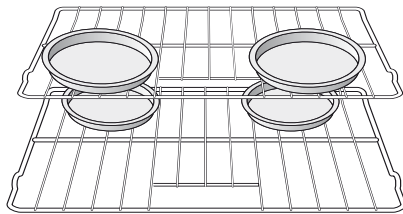
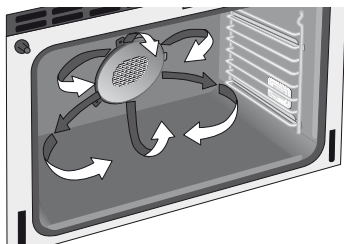

Pan position for two rack baking.

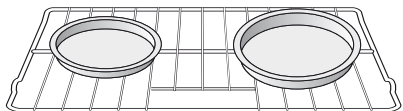

Pan position for one rack baking.

Setting convection bake

The following temperature settings apply to the conv bake feature:

- Auto-suggest (default) setting: **350°F / 176°C**
- Min. bake setting : **170°F / 76°C**
- Max. bake setting: **550°F / 288°C**

See the example below to set conv bake, starting immediately with the auto-suggest (default) setting of 350°F (176°C):

Example	
Step	Press
1. Press LOWER OVEN	LOWER OVEN
2. Press CONV BAKE	
3. Press START	

Once **START** is pressed the oven will begin heating. The oven display shows **PRE-HEATING** during this time.

After the oven reaches set temperature, **PRE-HEATING** will turn off and a beep will indicate the oven is ready. The oven will continue to maintain this temperature until the cooking feature is canceled.



For best results

- When baking with a single rack use rack positions 5. When using 2 racks use rack positions 3 & 7. When using 3 racks use rack positions 2, 5 & 8.
- Cookies and biscuits should be baked on pans with no sides or very low side to allow heated air to circulate around the food.
- Food baked on pans with a dark finish will cook faster.
- When placing multiple food items in the oven allow 2-4" (5-10cm) of space between the food items for proper air circulation.

NOTE

- You may press **CANCEL** any time when setting the control or when cooking.

Using convection convert

The conv convert option allows you to convert any normal baking recipe using the convection bake feature. The control uses the normal recipe settings and adjusts to a lower temperature for convection baking. Conv convert must be used with CONV BAKE feature.

Benefits of conv bake using conv convert option:

- Superior multiple oven rack performance.
- Some foods cook up 25 to 30% faster, saving time and energy.
- No special pans or bakeware required.



For best results

- When baking with a single rack use rack positions 5. When using 2 racks use rack positions 3 & 7. When using 3 racks use rack positions 2, 5 & 8.
- Cookies and biscuits should be baked on pans with no sides or very low side to allow heated air to circulate around the food.
- Food baked on pans with a dark finish will cook faster.
- When placing multiple food items in the oven allow 2-4" (5-10cm) of space between the food items for proper air circulation.



NOTE

- You may press CANCEL any time when setting the control or during the cooking process.

Setting convection convert

See the example below to set conv bake, starting immediately with the auto-suggest (default) setting of 350°F (176°C) and adding the conv convert option.

Example	
Step	Press
1. Press LOWER OVEN	LOWER OVEN
2. Press CONV BAKE	
3. Press COOK OPTIONS	
4. Press CONV CONVERT	
5. Press START	

Once **START** is pressed the oven display shows **PRE-HEATING**. After the oven reaches the converted set temperature, **PRE-HEATING** will turn off and a beep will indicate the oven is ready.

The added conv convert option will automatically **lower** the set temperature you set from the bake recipe to an adjusted conv bake temperature.

When conv convert is used with cook time, "**CF**" (Check Food) will display when the cook time is 75% complete. The control will also beep at regular intervals until baking has finished.

To add or change any cook settings after this feature has started:

- Select the **LOWER** oven. Make temperature changes using the + or - keys. Each press of + or - will adjust the temperature by 5° F (or 2°C).
- If changing cooking times, select the **cook time** or **end time** keys needed to make the changes.

About convection roast

How convection roast works

Convection roast is part of the Perfect-Convect³™ system. Convection roast combines a cook cycle with the convection fan and element to rapidly roast meats and poultry. Heated air circulates around the meat from all sides, sealing in juices and flavors. Meats cooked with this feature are crispy brown on the outside while staying moist on the inside. In addition, there is no need to reduce the oven temperature when using convection roast.

Convection roast may be set with the following options:

- Probe
- Cook time or cook time with end time

The following temperature settings apply to convection roast:

- Factory auto-start default: **350°F/176°C**
- Minimum: **170°F / 76°C**
- Maximum: **550°F / 288°C**

Benefits of convection roast:

- Superior multiple oven rack performance.
- Some foods cook up 25 to 30% faster, saving time and energy.
- No special pans or bakeware required.



For best results

- Preheating is not necessary for most meats and poultry.
- Place food items using the recommended rack positions for the type of food being prepared.
- When placing multiple food items in the oven allow 2-4" (5-10cm) of space between the food items for proper air circulation.
- Be sure to carefully follow your recipe's temperature and time recommendations or refer to the convection roast chart for additional information -p. 39, Fig. 2-

Setting convection roast

See example below to set convection roast to start immediately with the auto-suggest (default) setting:

Example	
Step	Press
1. Press LOWER OVEN	LOWER OVEN
2. Press CONV ROAST	
3. Press START	

Once START is pressed the oven will begin heating.

NOTE

- You may press CANCEL any time when setting the control or during the cooking process.

To add or change any cook settings after this feature has started:

- Select the **LOWER** oven. Make temperature changes using the + or - keys. Each press of + or - will adjust the temperature by 5° F (or 2°C).
- If changing cooking times, select the **cook time** or **end time** keys needed to make the changes.

Roasting recommendations

Roasting rack instructions

When preparing meats for convection roasting, you may use the broiler pan, insert and the roasting rack supplied with your appliance. The broiler pan will catch grease spills and the insert will help prevent grease splatters. The roasting rack fits on top of the insert allowing the heated air to circulate under the food for even cooking and helps to increase browning on the underside.

1. Place oven rack on bottom or next to the bottom oven rack position.
2. Place the insert on the broiler pan.
3. Make sure the roasting rack is securely seated on top of the insert. **Do not** use the broiler pan without the insert. **Do not** cover the insert with aluminum foil.
4. Position food (fat side up) on the roasting rack.
-Fig. 1-
5. Place prepared food on oven rack in the oven.

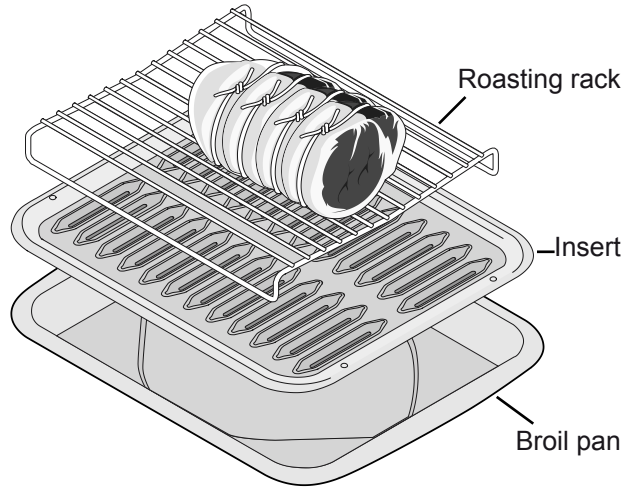

Fig. 1

Convection Roasting Chart					
Meat		Weight	Oven temp	Internal temp	Minute per lb.
Beef	Standing rib roast	4 to 6 lbs.	350°F	*	25-30
	Rib eye roast	4 to 6 lbs.	350°F	*	25-30
	Tenderloin roast	2 to 3 lbs.	400°F	*	15-25
Poultry	Turkey, whole**	12 to 16 lbs.	325°F	180°F	8-10
	Turkey, whole**	16 to 20 lbs.	325°F	180°F	10-15
	Turkey, whole**	20 to 24 lbs.	325°F	180°F	12-16
	Chicken	3 to 4 lbs.	350°F - 375°F	180°F	12-16
Pork	Ham roast, fresh	4 to 6 lbs.	325°F	160°F	30-40
	Shoulder blade roast	4 to 6 lbs.	325°F	160°F	20-30
	Loin	3 to 4 lbs.	325°F	160°F	20-25
	Pre-cooked ham	5 to 7 lbs.	325°F	160°F	30-40

* For beef: med rare 145°F, med 160°F, well done 170°F

Fig. 2

** Stuffed turkey requires additional roasting time. Shield legs and breast with foil to prevent overbrowning and drying of the skin.

About the probe function

Checking the internal temperature of your food is the most effective way of insuring that your food has been properly cooked. When cooking meat such as roasts, hams or poultry you can use the probe to check the internal temperature without any guesswork.

Your oven will automatically change from cooking to keep warm once the probe has reached the set temperature.

The following temperature settings apply to the probe function:

- Default: **170°F/76°C**
- Minimum: **130°F / 54°C**
- Maximum: **210°F / 98°C**

Setting the probe

Proper probe placement

- Always insert the probe so that the tip rests in the center of the thickest part of the meat. Do not allow the probe to touch bone, fat, gristle or the pan.
- For bone-in ham or lamb, insert the probe into the center of the lowest large muscle or joint. For dishes such as meat loaf or casseroles, insert the probe into the center of the food. To find the center of the food visually measure with the probe -Fig. 3-. When cooking fish, insert the probe just above the gill.
- For whole poultry or turkey, insert the probe into the thickest part of the inner thigh, below the leg -Fig. 1-.

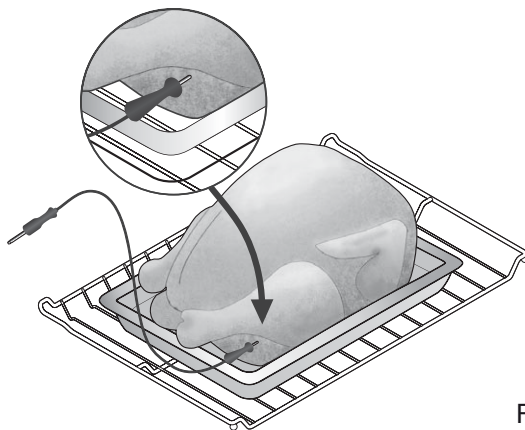

Fig. 1



Fig. 2

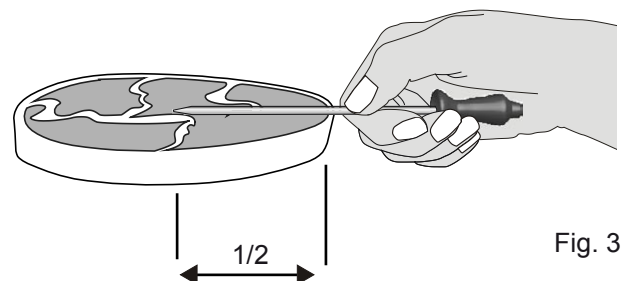

Fig. 3



→ IMPORTANT

- Use only the probe supplied with your appliance; any other may result in damage to the probe or the appliance.
- Be sure the probe is **fully** inserted into the probe receptacle. The probe will not work properly until correctly connected.
- Handle the probe carefully when inserting and removing it from the food and the receptacle.
- Do not use tongs to pull the cable when inserting or removing it from the food or the receptacle.
- Defrost your food completely before inserting the probe to avoid damaging probe.
- **Never leave or store the probe inside the oven when not in use.**
- To prevent the possibility of burns, carefully unplug the probe using a pot holder.

Setting the probe

See the example below to set the probe target temperature to 180°F/82°C when using the convection roast feature with oven set temperature for 325°F/162°C.

By the default, your oven will adjust to the **keep warm** setting once the probe has reached the set temperature.

Example	
Step	Press
1. Insert the probe into the food and place the food into the oven - <i>Fig. 1</i> -.	
2. Plug the probe COMPLETELY into the probe receptacle inside the oven - <i>Fig. 2</i> - and close the oven door.	
3. Press LOWER OVEN	LOWER OVEN
4. Press CONV ROAST	
5. Enter 325	325
6. Press START	
7. Press PROBE	
8. Enter 180	180
9. Press START	

* You may skip steps 7-9 if you choose to use the default internal target temperature of 170°F for the probe.

NOTE

- When the meat probe is connected to the receptacle and a cooking function is started, the display will show the current temperature reported by the meat probe.
- Any time during the cooking process you may press  to see or modify the target temperature.

About convection broiling

Convection broiling is part of the Perfect-Convect³™ system. Use the conv broil feature to cook thicker cuts of meats that require direct exposure to radiant heat and the convection fan for optimum browning results. This cooking feature is only available for the lower oven.

The following temperature settings apply to the conv broil feature:

- Auto-suggest (default) setting: **550°F / 288°C**
- Min. convection broil setting: **300°F / 148°C**
- Max. convection broil setting: **550°F / 288°C**

WARNING

Should an oven fire occur, leave the oven door closed and turn the oven OFF. If the fire continues, throw baking soda on the fire or use a fire extinguisher. **Do not** put water or flour on the fire. Flour may be explosive and water can cause a grease fire to spread and cause personal injury.

CAUTION

- **Do not** use the broiler pan without the insert. **Do not** cover the the broil pan or insert with aluminum foil; the exposed grease could ignite.
- To prevent food from contacting the broil element and to prevent grease splattering, **do not** use the roasting rack when broiling.





For best results

- Use the recommended pans and rack positions. *-refer to setting broil section-*
- For optimum results preheat oven for 5-6 minutes.

Setting convection broil

See example below to set conv broil for the lower oven to start immediately with the auto-suggest (default) setting.

Example	
Step	Press
1. Place the broiler insert on the broiler pan, then place the meat on the insert. Remember to follow all warnings and cautions.	
2. Arrange the interior oven rack <i>-refer to setting broil section-</i> for position recommendations. Be sure to place the prepared food and pan directly under broil element. Close the oven door.	
3. Press LOWER OVEN	LOWER OVEN
4. Press CONV BROIL	
5. Press START	

NOTE

You may press CANCEL any time when setting the control or during the cooking process.

To add or change any cook settings after this feature has started:

- Select the **LOWER** oven. Make temperature changes using the + or - keys. Each press of + or - will adjust the temperature by 5° F (or 2°C).

About keep warm

Use the keep warm feature to keep hot foods warm. Keep warm may be set with the following options:

- Cook time
- Cook time with end time

The following temperature settings apply to the keep warm feature:

- Auto-suggest (default) setting: **170°F / 76°C**
- Min. keep warm setting: **150°F / 66°C**
- Max. keep warm setting: **190°F / 88°C**



WARNING

- **FOOD POISONING HAZARD. Do not let food sit for more than one hour before or after cooking. Doing so may cause bacteria to grow which can result in food poisoning or sickness.**
- To prevent food from contacting the broil element and to prevent grease splattering, **do not** use the roasting rack when broiling.



NOTE

You may press CANCEL any time when setting the control or during the cooking process.

Setting keep warm

See example below to set keep warm for the lower oven to start immediately with the auto-suggest (default) setting.

Example	
Step	Press
1. Press LOWER OVEN	LOWER OVEN
2. Press KEEP WARM	
3. Press START	

To add or change any cook settings after this feature has started:

- Select the **LOWER** oven. Make temperature changes using the + or - keys. Each press of + or - will adjust the temperature by 5° F (or 2°C).

About slow cook

The slow cook feature may be used to cook foods more slowly at lower oven temperatures. The cooking results will be like that of a Slow Cooker or Crock-Pot. This feature is ideal for roasting beef, pork & poultry. Slow cooking meats may result in the exterior of meats becoming dark but not burnt; this is normal. Slow cook may only be set in the lower oven.

Slow cook may be set with the following options:

- Cook time
- Cook time with end time

The following temperature settings apply to the slow cook feature:

- Hi: 275°F / 134°C (default) for cooking 4 to 5 hours
- Lo: 225°F / 108°C for cooking 8 to 9 hours





For best results

- Completely thaw all frozen foods before cooking.
- Position multiple racks to accommodate size of cooking utensils when cooking multiple food item.
- Add any cream or cheese sauces during the last hour of cooking.
- Do not open the oven door often or leave the door open when checking foods. The more heat that is lost, the longer the food will need to cook.
- Cover the foods to keep them moist or use a loose or vented type cover to allow foods to turn crisp or brown.
- Roasts may be left uncovered so browning can occur. Cook times will vary depending on the weight, fat content, bone & the shape of the roast.
- Preheating the oven will not be necessary.

Setting slow cook

See the example below to set a slow cook on Lo.

Example	
Step	Press
1. Press LOWER OVEN	LOWER OVEN
2. Press SLOW COOK	
3. Press -lo to choose the Lo option <i>-Fig. 2-.*</i>	- lo
4. Press START	

Press **+hi to choose the Hi option -Fig. 1-.*



Fig. 1



Fig. 2

NOTE

You may press CANCEL any time when setting the control or during the cooking process.

To add or change any cook settings after this feature has started:

- Select the **LOWER** oven. Toggle between the high and low settings by using the **+** or **-** keys.
- If changing cooking times, select the **cook time** or **end time** keys needed to make the changes.

About Perfect Turkey™

Heated air circulates around the turkey from all sides, sealing in juices and flavors. Poultry cooked with this feature are crispy brown on the outside while staying moist on the inside.

Perfect turkey combines a cook cycle with the convection fan. The probe is used to monitor the exact internal temperature of the turkey while cooking. Once the turkey has reached the set temperature, the oven will stop cooking and change to keep warm.



Before setting the perfect turkey feature, or if you would like to change the probe target temperature, be sure to carefully read and follow **setting the probe** instructions.

NOTE

- You may press CANCEL any time when setting the control or during the cooking process.
- When the meat probe is connected to the receptacle and perfect turkey is started, the display will show the current temperature reported by the meat probe.
- Any time during the cooking process you may press  to see or modify the target temperature.
- It is not recommended to modify the perfect turkey settings once cooking has started. Doing so may not provide the best results.

Setting Perfect Turkey™

See the example below to use perfect turkey at the default setting of 325°F and the probe at the default setting of 180°F (82°C).

Example	
Step	Press
1. Insert the probe into the thickest part of the meat and place the turkey in the oven -see <i>setting the probe section-</i>	
2. Plug the probe into the probe receptacle inside the lower oven.	
3. Press LOWER OVEN	LOWER OVEN
4. Press PERFECT TURKEY Probe indicator will flash and Perfect Turkey will not start until the probe has been plugged in.	
5. Press START	

Perfect Turkey Chart

Meat	Weight	Oven temp	Internal temp	Minute per lb.	
Poultry	Turkey, whole**	12 to 16 lbs.	325°F	180°F	8-10
	Turkey, whole**	16 to 20 lbs.	325°F	180°F	10-15
	Turkey, whole**	20 to 24 lbs.	325°F	180°F	12-16
	Chicken	3 to 4 lbs.	350°F - 375°F	180°F	12-16

* Stuffed turkey requires additional roasting time. Shield legs and breast with foil to prevent overbrowning and drying of the skin.

46 Setting Lower Oven Controls

About defrost



Use the defrost feature to thaw small portions of delicate items such as cream cakes, frozen cream pies and cheesecake at room temperature. While in the defrost mode, the convection fan will operate to circulate room temperature air around the food slowly, accelerating the natural defrosting of the food without using heat.

Defrost may be set with the following options:

- Cook time
- Cook time with end time

Setting defrost

See the example below to set defrost.

Example	
Step	Press
1. Place food in oven and press LOWER OVEN	LOWER OVEN
2. Press DEFROST	
3. Press START	

NOTE

- You may press CANCEL any time when setting the control or during the cooking process.
- This feature is not meant for thawing frozen meats, poultry, seafood or other foods that need to be cooked before serving. Follow USDA recommendations for thawing foods. Only frozen foods that can be defrosted and served without cooking should be used with this feature.

About dehydrate

The dehydrate feature dries with heat from the elements. The heat is circulated throughout the oven by the convection fan. Use dehydrate to dry and/or preserve foods such as fruits, vegetables, herbs and very thin slices of meat. The Convection fan may operate while dehydrating.

The following temperature settings apply to the dehydrate feature:



- Auto-suggest (default) setting: **120°F / 48°C**
- Min. dehydrate setting: **100°F / 38°C**
- Max. dehydrate setting: **225°F / 108°C**

Dehydrate may be set with the following options:

- Cook time
- Cook time with end time

Setting dehydrate

See the example below to set dehydrate at the default temperature of 120°F.

Example	
Step	Press
1. Press LOWER OVEN	LOWER OVEN
2. Press DEHYDRATE	
3. Press START	

To add or change any cook settings after this feature has started:

- Select the **LOWER** oven. Make temperature changes using the **+** or **-** keys. Each press of **+** or **-** will adjust the temperature by 5° F (or 2°C).
- If changing cooking times, select the **cook time** or **end time** keys needed to make the changes.

Setting dehydrate



For best results

- Dry most fruits and vegetables at 140°F. Dry herbs at 100°F.
- Drying times vary depending on the moisture and sugar content of the food, the size of the pieces, the amount being dried and the humidity in the air.
- Treat fruits with antioxidants to avoid discoloration.
- Tightly woven cooling racks can be used to allow the air to circulate around the food; or use drying racks to allow the air to circulate around the food (this type of oven rack is not supplied with this appliance).
- Consult a food preservation book or library for information.

About bread proof

The bread proof feature maintains a warm environment useful for rising yeast-leavened products.

The following temperature settings apply to the bread proof feature:

- Auto-suggest (default) setting: **100°F/38°C**
- Min. bread proof setting: **85°F/30°C**
- Max. bread proof setting: **100°F / 38°C**

Bread proof may be set with the following options:

- Cook time
- Cook time with end time

Setting bread proof

See example below to set bread proof for 85°F / 30°C.

Example	
Step	Press
1. Press LOWER OVEN	LOWER OVEN
2. Press BREAD PROOF	
3. Enter 85 .	85
4. Press START	



NOTE

You may press CANCEL any time when setting the control or during the cooking process.

To add or change any cook settings after this feature has started:

- Select the **LOWER** oven. Make temperature changes using the + or - keys. Each press of + or - will adjust the temperature by 5° F (or 2°C).
- If changing cooking times, select the **cook time** or **end time** keys needed to make the changes.



For best results

- Lightly cover the dough
- Place a bowl of hot water on the rack below.
- Use the oven light to check progress. Do not open the oven door.



About my favorite

You may store up to 3 of your most frequently used heat settings and cooking times, for the lower oven. These keys will light in the display when they are available for setting or recalling.

Each key will allow you to store a cooking feature, oven set temperature and a cook time, for the lower oven.

Saving my favorite instructions

The example below shows how to save a favorite cooking instruction.



Example	
Step	Press
1. Press LOWER OVEN	LOWER OVEN
2. Input the cooking instructions using the control keypads and any additional options you wish to save and later recall.	
3. Press START	
4. Press and hold the available MY FAVORITE for 3 seconds.	
5. Press CANCEL/off*	

You will hear a beep and a red light will display above the selected favorite to indicate that your favorite recipe has been stored.

*If you wish to store the cooking instructions but not start the oven.

Recalling a favorite

The example below shows how to recall a favorite cooking instruction.

Example	
Step	Press
1. Press LOWER OVEN	LOWER OVEN
2. Choose MY FAVORITE	
3. Press START	

Deleting a favorite

You need to delete a favorite before saving another. Choose one of the favorite keys you no longer wish to keep and store the new cooking instructions using the deleting instructions.

The example below shows how to delete a favorite cooking instruction.

Example	
Step	Press
1. Press LOWER OVEN	LOWER OVEN
2. Press and hold the available MY FAVORITE for 3 seconds. The favorite key will disappear from the control panel.	

Perfect Program™ multi stage



Multi stage will allow you to program up to 3 stages of cooking. Each stage may be programmed with a cooking feature, set temperature and a cook time. Multi stage is ideal when you want to add a keep warm after a cooking function.





The following functions may be set with multi stage:

- Bake/conv bake
- Broil/conv broil (10 minutes max.)
- Conv roast
- Keep warm

Setting multi stage







See the example to program a multi stage feature for a casserole. For stage 1, bake at 400°F for 1 hr. For stage 2, to brown, broil for at 500°F for 4 minutes.



Example for 2 stages	
Step	Press
1. Press LOWER OVEN	LOWER OVEN
2. Press MULTI STAGE	1/2/3
— Stage 1 —	
3. Press BAKE	
4. Enter 400°F	400
5. Press START	
6. Enter 60 minutes	60
7. Press START	

Example for 2 stages	
Step	Press
— Stage 2 —	
8. Press BROIL	
9. Enter 500°F	500
10. Press START	
11. Enter 4 minutes	4
12. Press START/enter a total of 2 times to program only 2 stages and begin cooking.	 

Setting multi stage

See the example to program a multi stage feature for a casserole. For stage 1, bake at 350°F for 1 hr. For stage 2, to brown, broil for at 500°F for 4 minutes. For stage 3, keep warm for 15 minutes.

Example for 3 stages	
Step	Press
1. Press LOWER OVEN	LOWER OVEN
2. Press MULTI STAGE	1/3
— Stage 1 —	
3. Press BAKE	
4. Enter 350°F	350
5. Press START	
6. Enter 60 minutes	60
7. Press START	
— Stage 2 —	
8. Press BROIL	
9. Enter 500°F	500
10. Press START	
11. Enter 4 minutes	4
12. Press START	

Example for 3 stages	
Step	Press
— Stage 3 —	
13. Press KEEP WARM	
14. Enter 170°F	170
15. Press START	
16. Enter 15 minutes	15
17. Press START	

Sabbath mode

The lower oven of this appliance provides special settings for use when observing the Jewish Sabbath/Holidays. This mode will turn off all audible tones or visual display changes normally provided by the oven control. **BAKE** is the only cooking features available while in the Sabbath mode.

You must first set the **BAKE** feature and temperature(s) needed for the lower oven, the **COOK TIME** option if needed before setting the Sabbath mode. Any settings made prior to setting the Sabbath mode will be visible in the displays.

The Sabbath mode will override the factory preset 12 Hour Energy Saving mode and the appliance will stay on until the cooking features are cancelled. If any of the cooking features are cancelled when the appliance is in the Sabbath mode, no audible or visual indicators will be available to verify the cancellation.

If the oven interior lights are needed, be sure to activate them prior to setting the Sabbath mode. Once the oven light is turned ON and the Sabbath mode is active, the oven light will remain on until the Sabbath mode is turned off and the oven lights are turned off. The oven door will not activate the oven interior lights when the oven door is opened or closed.

It is recommended that any oven temperature modification made within an active Sabbath mode be followed with 2 presses of the **START** key. This will insure the oven remains ON even if an attempt is made to set the oven temperature outside of its temperature range. If the oven temperature is set outside of the temperature range, the oven will default to the nearest available temperature. Try to set the desired oven temperature again.

Should a power failure or interruption occur during the Sabbath/Holidays, the appliance will shut OFF. When power is restored the appliance will not turn back on automatically to the original BAKE feature settings. **SF** will appear in all the control display panels indicating a Sabbath mode failure. - Figs. 1- After a power failure, the food may be safely removed from the oven while still in the Sabbath mode.



Fig. 1





For further assistance, guidelines for proper usage and a complete list of models with the Sabbath feature, please visit the web at <http://www.star-k.org>.

NOTE

No Sabbath mode is available for microwave oven. When Sabbath mode is enabled, the microwave controls will lock and it will not be possible to turn it ON. If the microwave is active when Sabbath is set, it will turn off and lock.

Setting Sabbath mode

The example below shows setting the oven to observe the Sabbath (and Jewish holidays).

Example	
Step	Press
1. Press LOWER OVEN	LOWER OVEN
2. Press BAKE .	
Be sure to make any additional oven setting changes before going to step 3	
3. Press START	
4. To enter Sabbath mode, press and hold simultaneously both the LO and HI keys together for 3 seconds (a beep will sound) and release.	- lo & hi +

Once properly set in Sabbath mode, SAb -Fig. 1- will show in the oven display until the Sabbath mode is cancelled.



The image shows an oven's digital display. On the left, the letters 'SAb' are displayed in a large font, with a small 'O' above the 'A'. On the right, the time '8:00' is displayed in a smaller font, with 'HR' above the first '0' and 'MIN' above the second '0'.



Fig. 1

Canceling Sabbath mode

The example below shows how to cancel the Sabbath mode.

Example	
Step	Press
1. Press and hold both the LO and HI keys together for 3 seconds (a beep will sound) and release.	- lo & hi +
2. All cooking features previously set will automatically cancel once Sabbath mode has ended.	

NOTES





The only keys available once the appliance is set for the Sabbath mode are **hi**, **lo**, ,  & .

You may change the oven temperature and any cooktop settings once baking has started (Jewish holidays only). Choose oven and press **BAKE**, use the **+** or **-** keys to set the oven temperature and press **START twice**. Each press of **+** or **-** will adjust the temperature by 5° F (or 2°C). Remember that **the oven control will no longer beep or display any further changes** once the oven is set in the Sabbath mode.

Wave-Touch™ user preferences

The  key controls options for preferences. The display will show a digital abbreviation and a value for every preference each time a key is pressed one at a time.

Please read the following instructions before changing the user preferences functions:

- Press and continue to press **USER PREF**  to navigate through the preferences.
- Press **+hi** or **-lo** to toggle between options for each preference.
- Press **+hi** or **-lo** to increase or decrease numeric values. You may also use the numeric keys to input precise values.
- Press **START**  to accept a new option entry or press **USER PREF**  to advance to the next preference.
- Press **CANCEL**  to exit the preferences mode .

Setting clock display

The clock display mode allows you to turn the clock display on or off.

See the example below to change the clock display to OFF.



Example	
Step	Press
1. Press and continue to press USER PREF until you reach the preset clock display mode -Fig. 2-	
2. Use the +hi & -lo to toggle to the CLO off option -Fig. 3-	+ - hi or lo
3. Press START to accept or press CANCEL to reject.	



Fig. 2

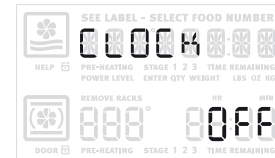

Fig. 3

Setting clock

See the example below to set the clock to 1:30.



Example	
Step	Press
1. Press USER PREF .	
2. Enter 1:30 or use +hi/-lo to advance to 1:30.	130
3. Press START to accept or press CANCEL to reject.	



Fig. 1

NOTE

User preference options are not available while cooking or when using the kitchen timer.

54 Setting Your Preferences

Setting 12 or 24 hour mode

The clock display mode allows you to choose between 12 and 24 hour mode. The factory preset clock display mode is 12 hour.

See the example below to change the default mode to 24 hour.



Example	
Step	Press
1. Press and continue to press USER PREF until you reach the preset clock display mode -Fig. 1-	
2. Use the +hi & -lo to toggle to the 24hr option. -Fig. 2-	+ - hi or lo
3. Press START to accept or press CANCEL to reject.	



Fig. 1

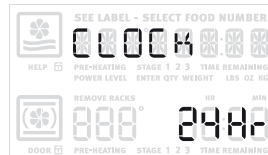



Fig. 2

Changing between F° or C°

Your control has the ability to display and set Fahrenheit or Celsius temperatures. The factory preset temperature display is Fahrenheit.

See the example below to change the default temperature display to Celsius.

Example	
Step	Press
1. Press and continue to press USER PREF until you reach the Fahrenheit/Celsius mode. -Fig. 1-	
2. Use the +hi or -lo to toggle to the C option. -Fig. 2-	+ - hi or lo
3. Press START to accept or press CANCEL to reject.	

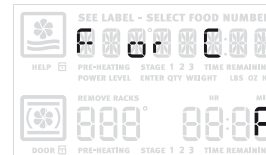

Fig. 1



Fig. 2

Setting 12hr energy saving mode

The oven control has a factory preset built-in 12 hour energy saving feature that will shut off the appliance if the oven has been heating for more than 11 hours and 59 minutes. The oven can be programmed to override this feature for continuous baking.

See the example below to turn off 12 hour energy saving mode.



Example	
Step	Press
1. Press and continue to press USER PREF until you reach the preset 12hr energy saving mode -Fig. 1-.	
2. Use the +hi & -lo to toggle to the off option -Fig. 2-.	+ - hi or lo
3. Press START to accept or press CANCEL to reject.	



Fig. 1



Fig. 2

Setting audio mode

The audio mode allows you to control the audio for the oven control. You may turn the audio off and later return to operating with all the normal audible sounds and alerts.

See the example below when changing the audible settings.



Example	
Step	Press
1. Press and continue to press USER PREF until you reach the pre-set audio mode .	
2. Use the +hi or -lo to choose the off option -Fig. 1- or the on option -Fig. 2-.	+ - hi or lo
3. Press START to accept or press CANCEL to reject.	



Fig. 1





Fig. 2

Adjusting oven temperature User preference offset

Your appliance has been factory calibrated and tested to ensure an accurate baking temperature. For the first few uses, follow your recipe times and temperature recommendations carefully.

If you feel your oven is too hot or too cool from your baking experience, the oven temperature may be adjusted to your liking. The temperature may be increased up to +35°F (+19°C) or decreased down to -35°F (-19°C) from normal.

See the example below to increase the temperature in the **lower oven**.

Example	
Step	Press
1. Press and continue to press USER PREF until you reach the user preference offset mode -Figs. 1-	
2. Press +hi to adjust the temperature higher. -Fig. 2-	+ hi
3. Use +hi to advance to 10 -Fig. 2-	+ hi or 10
4. Press START to accept or press CANCEL to reject.	

To set the temperature lower use the lo- key.



Fig. 1



Fig. 2

Factory default reset

You may choose to restore your factory settings. **This will erase all settings or favorites that you have saved.**

See the example below reset your control.



Example	
Step	Press
1. Press and continue to press USER PREF until you reach the factory default reset mode. -Fig. 1-	
2. Use the +hi or -lo to toggle to the on option to reset -Fig. 1-	+ - hi or lo
3. Press START to accept or press CANCEL to reject.	



Fig. 1



Fig. 2

User preferences chart

The following chart will help you navigate through the user preferences.

User Preferences Options		
Preference	1st option	2nd option*
Setting clock		
Clock display		
12 or 24 hour mode		
F° or C°		
12hr energy save mode		
Audio mode		
User Programmable Offset		
Reset to factory pre-sets		

Before starting self-clean

A self-cleaning oven automatically cleans with high temperatures that are well above those used for normal cooking. The self-clean feature eliminates soils completely or reduces them to a fine powdered ash that you can later easily wipe away with a damp cloth.

Adhere to the following precautions when running the self-clean cycle:

- **Do not** use oven cleaners or protective coatings in or around the oven interior.
- **Do not** clean the oven door gasket. The woven material of the oven door gasket is essential for a good seal. Care should be taken not to rub, damage or remove the gasket. *-Fig. 1-*
- **Do not** use any cleaning materials on the door gasket. Leaving chemical residue can damage the door gasket.
- **DO NOT** force the oven door open. The automatic door locking system can be damaged.
- **Remove** the broiler pan, insert, all utensils and any **aluminum foil**. These items cannot withstand high cleaning temperatures.
- All oven racks and supports **MUST** be removed. If they are left in while attempting to set a self-clean cycle, the display will show **REMOVE RACKS** *-Fig. 2.* The oven control will not start a self-clean cycle without first removing all the oven racks and supports.
- **Remove any excessive spillovers** in the oven cavity **before** starting a self-clean cycle. To clean, use hot, soapy water and a cloth. Large spillovers can cause heavy smoke or fire when subjected to high temperatures.
- Clean any soil from the oven frame, the door liner outside the oven door gasket and the small area at the front center of the oven bottom with soap and water. These areas heat sufficiently to burn soil on.
- **Do not** allow food spills with a high sugar or acid content (such as milk, tomatoes, sauerkraut, fruit juices or pie filling) to remain on the porcelain surface, they may leave a dull spot even after cleaning.

WARNING

During the self-clean cycle, the outside of the appliance can become very hot to the touch. **DO NOT** leave small children unattended near the appliance.

CAUTION

- **DO NOT** line the oven walls, oven racks, bottom or any other part of the range with aluminum foil. Doing so will stop heat distribution, produce poor baking results and cause permanent damage to the oven interior (aluminum foil will melt to the interior surface of the oven).
- Use caution when opening the door after the self-clean cycle is finished. The oven may still be **VERY HOT**.
- The health of some birds is extremely sensitive to the fumes given off during the self-cleaning cycle of any range. Move birds to another well-ventilated room.

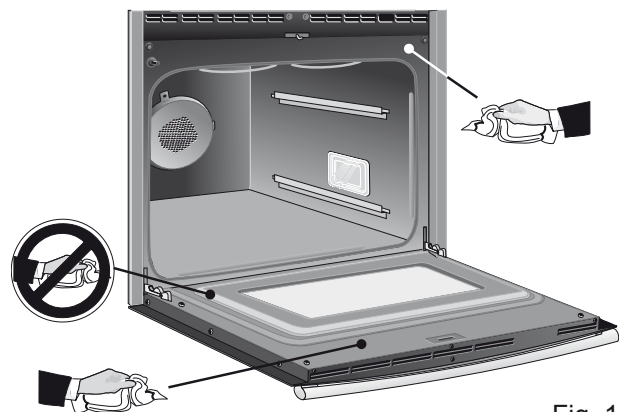



Fig. 1

REMOVE RACKS

Fig. 2

Setting self-clean

The clean feature provides 3 different choices for self-cleaning the lower oven. Set the clean for **lite** (2 hrs), **med** (3 hrs) or **heavy** soils (4 hrs). The example below shows setting the lower oven for self-clean to begin immediately using a medium (3 hour) setting:

Example	
Step	Press
1. Remove racks and supports and press LOWER OVEN	LOWER OVEN
2. Press CLEAN	
3. Select MED or select lite or heavy	med
4. Press START	

After pressing start, the motorized oven door latch will automatically lock the door. The DOOR lock icon will flash (Fig. 1). Once the door has locked the DOOR lock icon will remain on through the entire self-clean cycle.

After self-clean, the oven may take about 30-40 minutes to cool and unlock. A **Hot** message (Fig. 2) will display during this period. During cooling the DOOR lock icon will flash and disappear indicating that the door has unlocked.



Fig. 1



Fig. 2

→ IMPORTANT





- A self-clean cycle will not start if the appliance has the CONTROL LOCK turned on.
- If a self-clean cycle was started but did not finish due to a power failure, your oven may not be completely cleaned. After power has been restored and the oven door has unlocked, set for another self-clean if needed.

Setting delayed self-clean

You may wish to set your appliance to perform a self-clean cycle sometime later (up to 12 hours later). The **END TIME** key will determine when the cleaning will stop.

You will need to set the **END TIME** out far enough to allow for the type of clean cycle you choose (2-3-4 hours). Remember to add 30-40 additional minutes for the oven to cool enough and the oven door to unlock.

The example below shows setting the lower oven for a lite (2 hour) self-clean cycle to end at 8:00 o'clock:

Example	
Step	Press
1. Remove racks and press LOWER OVEN	LOWER OVEN
2. Press CLEAN	
3. Select LITE	lite
4. Press COOK OPTIONS	
5. Press END TIME	
6. Enter 800	800
7. Press START	

🗨️ NOTES

- You may press CANCEL any time during the cleaning process. After cancelling the self-clean cycle, do not attempt to open the oven door until the DOOR lock icon turns off.

Cleaning Recommendations

Surface Type	Cleaning Recommendation
<ul style="list-style-type: none"> • Aluminum (trim pieces) & vinyl 	Use hot, soapy water and a cloth. Dry with a clean cloth.
<ul style="list-style-type: none"> • Painted and plastic control knobs • Body parts, • Painted decorative trim 	<p><i>For general cleaning</i>, use hot, soapy water and a cloth. <i>For more difficult soils and built-up grease</i>, apply a liquid detergent directly onto the soil. Leave on soil for 30 to 60 minutes. Rinse with a damp cloth and dry. Do not use abrasive cleaners on any of these materials; they can scratch. To remove control knobs, turn to the OFF position; grasp firmly and pull straight off the shaft. To replace knobs after cleaning, line up the flat sides of both the knob and the shaft; then push the knob into place.</p>
<ul style="list-style-type: none"> • Chrome control panel (some models) • Decorative trim (some models) • Stainless steel (some models) 	<p><i>Before cleaning the control panel</i>, turn all controls to OFF and remove the control knobs. To remove, pull each knob straight off the shaft. Clean using hot, soapy water and a dishcloth. Rinse with a clean water using a dishcloth. Be sure to squeeze excess water from the cloth before wiping the panel; especially when wiping around the controls. Excess water in or around the controls may cause damage to the appliance. To replace knobs after cleaning, line up the flat sides of both the knob and the shaft; then push the knob into place.</p> <p>Stainless Steel (some models). Clean the stainless with warm soapy water using a clean sponge or cloth. Rinse with clean water and dry with a soft clean cloth. Do not use harsh scrubbing cleaners. Only use kitchen cleaners that are especially made for cleaning Stainless Steel. Always be sure to rinse the cleaners from the surface as bluish stains may occur during heating that cannot be removed.</p>
<ul style="list-style-type: none"> • Porcelain enamel broiler pan and insert (if equipped) • Door liner & body parts 	Gentle scouring with a soapy scouring pad will remove most spots. Rinse with a 1:1 solution of clear water and ammonia. <i>If necessary</i> , cover difficult spots with an ammonia-soaked paper towel for 30 to 40 minutes. Rinse with clean water and a damp cloth, and then scrub with a soap-filled scouring pad. Rinse and wipe dry with a clean cloth. Remove all cleaners or the porcelain may become damaged during future heating. Do not use spray oven cleaners on the cooktop.

Cleaning Recommendations

Surface Type	Cleaning Recommendation
<ul style="list-style-type: none">• Oven racks	<p>Oven racks must be removed. Clean by using a mild, abrasive cleaner following manufacturer's instructions. Rinse with clean water and dry.</p>
<ul style="list-style-type: none">• Oven door	<p>Use soap & water to thoroughly clean the top, sides and front of the oven door. Rinse well. You may use a glass cleaner on the outside glass of the oven door. Do not immerse the door in water. Do not spray or allow water or the glass cleaner to enter the door vents. Do not use oven cleaners, cleaning powders or any harsh abrasive cleaning materials on the outside of the oven door.</p> <p>Do not clean the oven door gasket. The oven door gasket is made of a woven material, on Self-Cleaning models, which is essential for a good seal. Care should be taken not to rub, damage or remove this gasket.</p>

The oven door with Luxury-Hold™ hinges

CAUTION

- To prevent possible burns, do not attempt to remove the oven door until the oven has completely cooled.
- To avoid possible injury to hands when removing or replacing the oven door, follow the instructions below carefully and always hold the oven door with hands positioned away from the door hinge area (See Fig. 3).

IMPORTANT

The oven door is heavy. Be careful when removing and lifting the door. Do not lift the oven door by the handle.

1. Fully open the oven door -Fig. 1-.
2. Unlock both oven door hinge locks by pulling them up and away from the oven frame until they stop (unlocked position) -Figs. 2-. If needed use a small flat-bladed screwdriver to assist with loosening the door hinge locks.
3. Firmly grasp both sides of oven door -Fig. 3-.
4. Before completing this step, be prepared to hold the whole weight of the door while grasping the sides of the oven door with both hands. Hold midway down the oven door sides. Close the oven door to about 4 inches and continue closing beyond the door stop position. The oven door should release from the frame on its own. -Fig. 3-.
5. Carefully lift door away evenly, slightly up and out until both hinge arms are clear of the hinge slots in the oven frame -Fig. 3-. After door has been removed, be sure to lay the door flat with the inside of the door downward (never rest the oven door with any weight on the door handle).

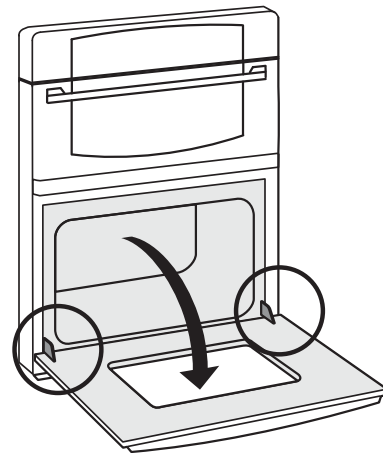

Fig. 1

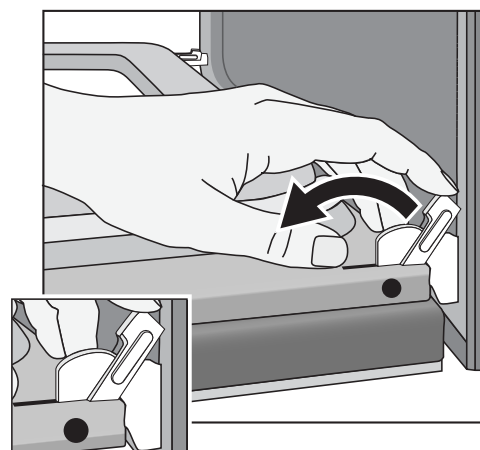

Fig. 2



Fig. 3

The oven door with Luxury-Hold™ hinges

To replace the Lift-Off oven door

1. Firmly grasp the oven door along both sides just below the door handle. When positioning the door hinge arms with the door hinge slots in the oven frame, you may wish to use your knee to stabilize the door before attempting to insert the door hinge arms in the hinge slots -*Fig. 1*-.
2. Position the angle of the door to the door removal angle and carefully insert the door hinge arms fully and evenly into the door hinge slots. Carefully let the weight of the door transfer from your hands so that the oven now supports the oven door.
3. Open the oven door down to the fully open position -*Fig. 2*-.
4. With the door in the fully open position, push both oven door hinge locks toward the oven frame until they both are locked -*Fig. 3*-.
5. Close the oven door.



Fig. 1



Fig. 2

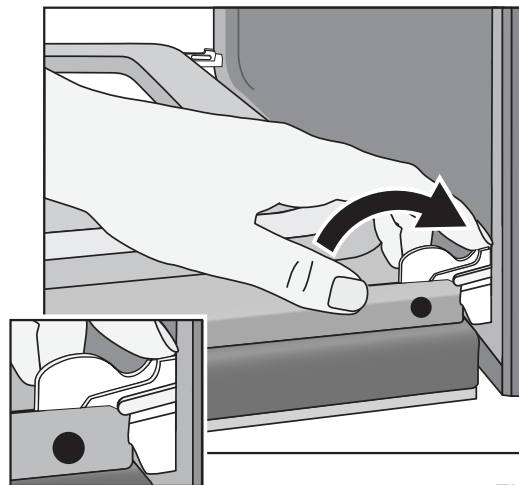

Fig. 3

Special door care instructions

→ IMPORTANT

Most oven doors contain glass that can break. Read the following recommendations:

- **Do not** close the oven door until all the interior oven racks are fully inserted and retracted to the back of the oven.
- Do not hit the glass with pots, pans, or any other object. The oven door glass may break or even break at a later time unexpectedly.
- Scratching, hitting, jarring or stressing the oven door glass may weaken its structure causing an increased risk of breakage at a later time.
- You may use a glass cleaner on the outside of the oven door glass. **Do not spray** or allow water or the cleaner to enter or drip down into the oven door vents. Spray cleaner on cloth first and then wipe the oven door clean.
- **Do not** use strong oven cleaners, powders or any harsh abrasive cleaning materials on the outside of the oven door or glass.
- **Never clean** the oven door gasket. The oven door gasket should always clean during the Self-clean cycle.

Changing lower oven lights

⚠ CAUTION

- Be sure the range is unplugged and all parts are **COOL** before replacing oven light. Wear a leather-faced glove for protection against possible broken glass or burns.

The lower oven light bulbs are located on both side of the oven cavity and both are covered with a glass shield. The glass shield must be in place whenever the oven is in use.

Replacing the lower oven interior light bulbs:

1. Turn electrical power off at the main source or unplug the appliance.
2. Remove lower oven interior light shield as illustrated below.
3. Replace bulb with a new **T-4 type 40 Watt Halogen** appliance bulb. Please note: do not allow your fingers to touch the new bulb when replacing. This will shorten the life of the new bulb. Use a paper towel to cover the new bulb when installing.
4. Replace glass shield over bulb.
5. Turn power back on again at the main source (or plug the appliance back in).
6. The clock will then need to be reset.

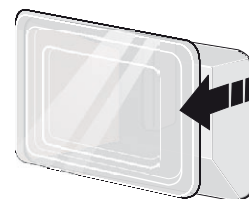

Lift backside
of glass shield
and remove it.

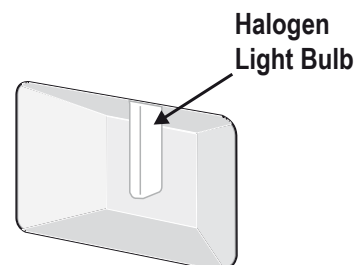

Disconnect the power cord before cleaning or leave the door open to inactivate the oven during cleaning.

Exterior

Clean the outside with mild soap and water; rinse and dry with a soft cloth. Do not use any type of household or abrasive cleaner.

Door

Wipe the window on both sides with a damp cloth to remove any spills or splatters. Metal parts will be easier to maintain if wiped frequently with a damp cloth. Avoid the use of spray and other harsh cleaners as they may stain, streak or dull the door surface.

Touch Control Panel

Care should be taken in cleaning the touch control panel. If the control panel becomes soiled, open the Microwave Oven door before cleaning. Wipe the panel with a cloth dampened slightly with water only. Dry with a soft cloth. Do not scrub or use any sort of chemical cleaners. Close door and touch **STOP/CLEAR**.

Interior

Cleaning is easy because little heat is generated to the interior surfaces; therefore, there is no baking and setting of spills or spattering. To clean the interior surfaces, wipe with a soft cloth and warm water. **DO NOT USE ABRASIVE OR HARSH CLEANERS OR SCOURING PADS.** For heavier soil, use baking soda or a mild soap; rinse thoroughly with hot water. The rack can be cleaned with hot soapy water, rinsed and dried. **NEVER SPRAY OVEN CLEANERS DIRECTLY ONTO ANY PART OF THE MICROWAVE OVEN.**

Waveguide Cover

The waveguide cover is made from mica so requires special care. Keep the waveguide cover clean to assure good oven performance. Carefully wipe with a damp cloth any food splatters from the surface of the cover immediately after they occur. Built-up splashes may overheat and cause smoke or possibly catch fire. Do not remove the waveguide cover.

Odor Removal

Occasionally, a cooking odor may remain in the oven. To remove, combine 1 cup water, grated peel and juice of 1 lemon and several whole cloves in a 2-cup glass measuring cup. Boil for several minutes using 100% power. Allow to set in oven until cool. Wipe interior with a soft cloth.

Turntable/Turntable Support/Racks

The turntable, turntable support and racks can be removed for easy cleaning. Wash them in mild, sudsy water; for stubborn stains use a mild cleanser and a non-abrasive scouring sponge. They are also dishwasher-proof. Use top rack of dishwasher for turntable support.

Foods with high acidity, such as tomatoes or lemons, will cause the porcelain enamel turntable to discolor. Do not cook highly acidic foods directly on the turntable; if spills occur, wipe up immediately.

The turntable motor shaft is not sealed, so excess water or spills should not be allowed to stand in this area.

Before you call for service, review the following list. It may save you time & expense. The list includes common occurrences that are not the result of defective workmanship or materials in this appliance.

Before you call	
Problem	Solution
Faulty Installation	<ul style="list-style-type: none"> Place oven rack in center of oven. Place a level on the oven rack. Contact installing agent if rack and cabinet cutout flooring are not level. Kitchen cabinet misalignment may make oven appear to be not level. Be sure cabinets are square and level. Contact cabinet maker to correct problem.
Entire appliance does not operate	<ul style="list-style-type: none"> The time of day is not set. The time of day must first be set in order to operate the oven. See “Setting clock at power up” in the Getting Started section. Be sure electrical cord is securely connected into the electrical junction box. Cord/plug is not installed and/or connected. Cord is not supplied with oven. Contact your dealer, installing agent or authorized servicer. Service wiring is not complete. Contact your dealer, installing agent or authorized service agent. Electrical power outage. Check house lights to be sure. Call your local electric company for service. Short in cord/plug. Replace cord/plug. Controls are not set properly. See instructions to set the controls. House fuse has blown or circuit breaker has tripped immediately following installation. House fuse may not be fully engaged. Check fuse and screw or engage circuit breaker securely.
Oven does not operate	<ul style="list-style-type: none"> Be sure the oven controls are set properly for the desired cooking feature. See Setting Lower Oven Controls in this Use & Care Guide or read the instructions “Entire appliance does not operate” in this checklist.
Oven light does not work	<ul style="list-style-type: none"> Replace or tighten bulb. See “Changing lower oven lights” sections in this Use & Care Guide.
Self-cleaning cycle does not work	<ul style="list-style-type: none"> Make sure the oven door is closed. Make sure you have removed the oven racks and the oven rack supports from the oven. Controls not set properly. Follow instructions under “Using the Self-Clean Feature”.
Flames inside oven or smoking from oven vent	<ul style="list-style-type: none"> Excessive spillovers in oven. For example this will happen for pie spillovers or large amounts of grease left on the oven bottom. Wipe up excessive spillovers before starting oven. If flames or excessive smoke are present see “About broiling” in the Setting Lower Oven Controls section.





Before you call

Problem	Solution
Soil not completely removed after self-cleaning cycle is completed	<ul style="list-style-type: none"> • Failure to clean bottom, from top of oven, frame of oven or door area outside oven seal. These areas are not in the self-cleaning area, but get hot enough to burn on residue. Clean these areas before the self-cleaning cycle is started. Burned on residue can be cleaned with a stiff nylon brush and water or a nylon scrubber. Be careful not to damage the oven gasket. • Excessive spillovers in oven. Set the self-clean cycle for longer cleaning time.
Oven smokes excessively during broiling	<ul style="list-style-type: none"> • Control not set properly. Follow broiling instructions under Setting Oven Controls. • Meat too close to the broil element. Reposition the broil rack to provide proper clearance between the meat & the element. Preheat the broil element for searing. • Meat not properly prepared. Remove excess fat from meat. Cut remaining fatty edges to prevent curling, but do not cut into lean. • Insert on broiler pan wrong side up & grease not draining. Always place grid on the broiler pan with ribs up & slots down to allow grease to drip into pan (some models). • Grease has built up on oven surfaces. Regular cleaning is necessary when broiling frequently. Old grease or food spatters cause excessive smoking.
Oven control panel beeps & displays any F code error (for example F10)	<ul style="list-style-type: none"> • Oven control has detected a fault or error condition. Press CANCEL to clear the display & stop beeping. Try the bake or broil feature again. If the F code error repeats, remove power supply to appliance, wait 5 minutes and then repower the appliance and set clock for the time of day. Try the bake or broil feature again. If the fault recurs, record fault and call for service.
Poor baking results	<ul style="list-style-type: none"> • Many factors affect baking results. Make sure the proper oven rack position is used. Center food in the oven and space pans to allow air to circulate. Allow the oven to preheat to the set temperature before placing food in the oven. Try adjusting the recipe's recommended temperature or baking time. If you feel the oven is too hot or cool, see "Adjusting Oven Temperature" in the Setting Your Preferences section of this Use & Care Guide.

Baking problems

For best cooking results pre-heat the oven when baking cookies, breads, cakes, pies or pastries, etc... There is no need to preheat the oven for roasting meats or baking casseroles. The cooking times and temperatures needed to bake a product may vary slightly from your previous appliance.

Baking Problems and Solutions Chart

BAKING PROBLEMS	CAUSES	CORRECTIONS
<p>Cookies and biscuits burn on the bottom.</p> 	<ul style="list-style-type: none"> • Cookies and biscuits put into the oven before the preheating time is completed. • Oven rack overcrowded. • Dark pan absorbs heat too fast. 	<ul style="list-style-type: none"> • Allow oven to preheat to the selected temperature before placing food in oven. • Choose pan sizes that will permit 5.1cm to 10.2cm (2" to 4") of air space on all sides when placed in the oven. • Use a medium-weight aluminum baking sheet.
<p>Cakes too dark on top or bottom.</p> 	<ul style="list-style-type: none"> • Cakes put into the oven before preheating time is completed. • Rack position too high or low. • Oven too hot. 	<ul style="list-style-type: none"> • Allow oven to preheat to the selected temperature before placing food in the oven. • Use proper rack position for baking needs. • Set oven temperature 25°F/12°C lower than recommended.
<p>Cakes not done in the center.</p> 	<ul style="list-style-type: none"> • Oven too hot. • Incorrect pan size. • Pan not centered in oven. 	<ul style="list-style-type: none"> • Set oven temperature 25°F/12°C lower than recommended. • Use pan size suggested in recipe. • Use proper rack position and place pan so there is 5.1cm to 10.2cm (2" to 4") of space on all sides of pan.
<p>Cakes not level.</p> 	<ul style="list-style-type: none"> • Range not level. • Pan too close to oven wall or rack overcrowded. • Pan warped. 	<ul style="list-style-type: none"> • Place a marked glass measuring cup filled with water on the center of the oven rack. If the water level is uneven, refer to the installation instructions for leveling the range. • Be sure to allow 5.1cm to 10.2cm (2" to 4") of clearance on all sides of each pan in the oven. • Do not use pans that are dented or warped.
<p>Foods not done when cooking time is up.</p> 	<ul style="list-style-type: none"> • Oven too cool. • Oven overcrowded. • Oven door opened too frequently. 	<ul style="list-style-type: none"> • Set oven temperature 25°F/12°C higher than suggested and bake for the recommended time. • Be sure to remove all pans from the oven except the ones to be used for baking. • Open oven door only after shortest recommended baking time.

Please check the following before calling for service:

Place one cup of water in a glass measuring cup in the oven and close the door securely.

Operate the oven for one minute at HIGH 100%.

- A Does the oven light come on? YES _____ NO _____
- B Does the cooling fan work? YES _____ NO _____
(Put your hand over the front ventilating openings.)
- C Is the water in the oven warm? YES _____ NO _____

If “NO” is the answer to any of the above questions, please check electrical outlet, fuse and/or circuit breaker. If they are functioning properly, CONTACT YOUR NEAREST ELECTROLUX AUTHORIZED SERVICER.

A microwave oven should never be serviced by a “do-it-yourself” repair person.

Your appliance is covered by a one year limited warranty. For one year from your original date of purchase, Electrolux will repair or replace any parts of this appliance that prove to be defective in materials or workmanship when such appliance is installed, used, and maintained in accordance with the provided instructions. In addition, the glass cooktop or radiant surface element of your appliance (excluding built-in and free-standing range appliances) is covered by a two through five year limited warranty. During the 2nd through 5th years from your original date of purchase, Electrolux will provide a replacement glass cooktop or radiant surface element for your appliance which has proven to be defective in materials or workmanship when such appliance is installed, used, and maintained in accordance with the provided instructions.

Exclusions

This warranty does not cover the following:

1. Products with original serial numbers that have been removed, altered or cannot be readily determined.
2. Product that has been transferred from its original owner to another party or removed outside the USA or Canada.
3. Rust on the interior or exterior of the unit.
4. Products purchased "as-is" are not covered by this warranty.
5. Products used in a commercial setting.
6. Service calls which do not involve malfunction or defects in materials or workmanship, or for appliances not in ordinary household use or used other than in accordance with the provided instructions.
7. Service calls to correct the installation of your appliance or to instruct you how to use your appliance.
8. Expenses for making the appliance accessible for servicing, such as removal of trim, cupboards, shelves, etc., which are not a part of the appliance when it is shipped from the factory.
9. Service calls to repair or replace appliance light bulbs, air filters, water filters, other consumables, or knobs, handles, or other cosmetic parts.
10. Labor or in-home service costs during the additional limited warranty periods beyond the first year from your original date of purchase.
11. Pickup and delivery costs; your appliance is designed to be repaired in the home.
12. Surcharges including, but not limited to, any after hour, weekend, or holiday service calls, tolls, ferry trip charges, or mileage expense for service calls to remote areas, including the state of Alaska.
13. Damages to the finish of appliance or home incurred during transportation or installation, including but not limited to floors, cabinets, walls, etc.
14. Damages caused by: services performed by unauthorized service companies; use of parts other than genuine Electrolux parts or parts obtained from persons other than authorized service companies; or external causes such as abuse, misuse, inadequate power supply, accidents, fires, or acts of God.

DISCLAIMER OF IMPLIED WARRANTIES; LIMITATION OF REMEDIES

CUSTOMER'S SOLE AND EXCLUSIVE REMEDY UNDER THIS LIMITED WARRANTY SHALL BE REPAIR OR REPLACEMENT AS PROVIDED HEREIN. **CLAIMS BASED ON IMPLIED WARRANTIES, INCLUDING WARRANTIES OF MERCHANTABILITY OR FITNESS FOR A PARTICULAR PURPOSE, ARE LIMITED TO ONE YEAR OR THE SHORTEST PERIOD ALLOWED BY LAW, BUT NOT LESS THAN ONE YEAR.** ELECTROLUX SHALL NOT BE LIABLE FOR CONSEQUENTIAL OR INCIDENTAL DAMAGES SUCH AS PROPERTY DAMAGE AND INCIDENTAL EXPENSES RESULTING FROM ANY BREACH OF THIS WRITTEN LIMITED WARRANTY OR ANY IMPLIED WARRANTY. SOME STATES AND PROVINCES DO NOT ALLOW THE EXCLUSION OR LIMITATION OF INCIDENTAL OR CONSEQUENTIAL DAMAGES, OR LIMITATIONS ON THE DURATION OF IMPLIED WARRANTIES, SO THESE LIMITATIONS OR EXCLUSIONS MAY NOT APPLY TO YOU. THIS WRITTEN WARRANTY GIVES YOU SPECIFIC LEGAL RIGHTS. YOU MAY ALSO HAVE OTHER RIGHTS THAT VARY FROM STATE TO STATE.

If You Need Service

Keep your receipt, delivery slip, or some other appropriate payment record to establish the warranty period should service be required. If service is performed, it is in your best interest to obtain and keep all receipts. Service under this warranty must be obtained by contacting Electrolux at the addresses or phone numbers below.

This warranty only applies in the USA, Puerto Rico and Canada. In the USA and Puerto Rico, your appliance is warranted by Electrolux Major Appliances North America, a division of Electrolux Home Products, Inc. In Canada, your appliance is warranted by Electrolux Canada Corp. Electrolux authorizes no person to change or add to any obligations under this warranty. Obligations for service and parts under this warranty must be performed by Electrolux or an authorized service company. Product features or specifications as described or illustrated are subject to change without notice.

USA

1-877-435-3287

Electrolux Major Appliances North America
P.O. Box 212378
Augusta, GA 30907

Canada

1-800-265-8352

Electrolux Canada Corp.
5855 Terry Fox Way
Mississauga, Ontario, Canada L5V 3E4

 **Electrolux**
