

Use & Care Guide

Over the Range Microwave Oven

Guía de Uso y Cuidado

Horno microondas sobre la estufa

Mode d'emploi et d'entretien

Four à micro-ondes au dessus de la cuisinière



 **Electrolux**

Please read and save this guide

Thank you for choosing **Electrolux**, the new premium brand in home appliances. This Use & Care Guide is part of our commitment to customer satisfaction and product quality throughout the service life of your new appliance.

We view your purchase as the beginning of a relationship. To ensure our ability to continue serving you, please use this page to record important product information.

Keep a record for quick reference

Purchase date

Electrolux model number

Electrolux serial number (see picture for location)

NOTE

Registering your product with Electrolux enhances our ability to serve you. You can register online at www.electroluxappliances.com or by dropping your Product Registration Card in the mail.

Questions?

For toll-free telephone support in the U.S. and Canada:
1-877-4ELECTROLUX (1-877-435-3287)

For online support and Internet production information visit <http://www.electroluxappliances.com>

PRECAUTIONS TO AVOID POSSIBLE EXPOSURE TO EXCESSIVE MICROWAVE ENERGY

- (a) Do not attempt to operate this oven with the door open since open-door operation can result in harmful exposure to microwave energy. It is important not to defeat or tamper with the safety interlocks.
- (b) Do not place any object between the oven front face and the door or allow soil or cleaner residue to accumulate on sealing surfaces.
- (c) Do not operate the oven if it is damaged. It is particularly important that the oven door close properly and that there is no damage to the: (1) door (bent), (2) hinges and latches (broken or loosened), (3) door seals and sealing surfaces.
- (d) The oven should not be adjusted or repaired by anyone except properly qualified service personnel.

FINDING INFORMATION.....	2	AUTO COOKING.....	17
PRECAUTIONS TO AVOID POSSIBLE EXPOSURE TO EXCESSIVE MICROWAVE ENERGY	2	Auto cook	17
TABLE OF CONTENTS	3	Popcorn	17
IMPORTANT SAFETY INSTRUCTIONS	4	FAST RECIPE	18-20
UNPACKING AND EXAMING YOUR OVEN	5	Veggies / Meast / Poultry	18
GROUNDING INSTRUCTIONS	6	Fish / Desserts / Snacks / Breads,Grains....	19
INFORMATION YOU NEED TO KNOW	7-10	Casseroles / Melt,Soften / Frozen Meals Popcorn.....	20
About Your Oven	7	CONVENIENT FEATURES	21
About Microwave Cooking.....	7	CLEANING AND CARE.....	22-24
About Safety	8	SERVICE CALL CHECK	25
About Children and the Microwave.....	8	SPECIFICATIONS.....	26
About Food	9	WARRANTY INFORMATIONS	27
About Utensils and Coverings	10		
PART NAMES	11		
CONTROL PANEL.....	12		
BEFORE OPERATING	13		
To Set the Clock.....	13		
Stop/Clear	13		
Timer	13		
MANUAL COOKING.....	14-16		
Setting Your Microwave To Cook.....	14		
Quick Start	14		
Setting Microwave Cooking By Setting Power And Cooking Time	14		
To Set Power Level	14		
Convection	15		
Grille	15		
Setting Defrost.....	15		
Sensor Reheat.....	16		
Multiple Sequence Cooking.....	16		

IMPORTANT SAFETY INSTRUCTIONS

When using electrical appliances basic safety precautions should be followed, including the following:



WARNING

To reduce the risk of burns, electric shock, fire, injury to persons or exposure to excessive microwave energy:

1. **Read all instructions before using the appliance.**
2. Read and follow the specific “**PRECAUTIONS TO AVOID POSSIBLE EXPOSURE TO EXCESSIVE MICROWAVE ENERGY**” on page 2.
3. This appliance must be grounded. Connect only to properly grounded outlet. See “Grounding Instructions” on page 6.
4. Install or locate this appliance only in accordance with the provided installation instructions.
5. Some products such as whole eggs and sealed containers—for example, closed glass jars—are able to explode and should not be heated in this oven.
6. Use this appliance only for its intended use as described in this manual. Do not use corrosive chemicals or vapors in this appliance. This type of oven is specifically designed to heat, cook or dry food. It is not designed for industrial or laboratory use.
7. As with any appliance, close supervision is necessary when used by children.
8. Do not operate this appliance if it has a damaged cord or plug, if it is not working properly or if it has been damaged or dropped.
9. This appliance should be serviced only by qualified service personnel. Contact nearest Electrolux Authorized Servicer for examination, repair or adjustment.
10. Do not cover or block any openings on the appliance.
11. Do not store or use this appliance outdoors. Do not use this product near water—for example, near a kitchen sink, in a wet basement, near a swimming pool, or similar locations.
12. Do not immerse cord or plug in water.
13. Keep cord away from heated surfaces.
14. Do not let cord hang over edge of table or counter.
15. See door surface cleaning instructions on page 22.
16. Do not mount over a sink.
17. Do not store anything directly on top of the appliance surface when the appliance is in operation.
18. To reduce the risk of fire in the oven cavity:
 - a. **Do not overcook food. Carefully attend to appliance when paper, plastic or other combustible materials are placed inside the oven to facilitate cooking.**
 - b. Remove wire twist-ties from paper or plastic bags before placing bag in oven.
 - c. **If materials inside the oven ignite, keep oven door closed, turn oven off and disconnect the power cord or shut off power at the fuse or circuit breaker panel.**
 - d. Do not use the cavity for storage purposes. Do not leave paper products, cooking utensils or food in the cavity when not in use.
19. Liquids, such as water, coffee or tea are able to be overheated beyond the boiling point without appearing to be boiling. Visible bubbling or boiling when the container is removed from the Microwave Oven is not always present. **THIS COULD RESULT IN VERY HOT LIQUIDS SUDDENLY BOILING OVER WHEN A SPOON OR OTHER UTENSIL IS INSERTED INTO THE LIQUID.**

To reduce the risk of injury to persons:

 - a. Do not overheat the liquid.
 - b. Stir the liquid both before and halfway through heating it.
 - c. Do not use straight-sided containers with narrow necks. Use a wide-mouthed container.
 - d. After heating, allow the container to stand in the Microwave Oven at least for 20 seconds before removing the container.
 - e. Use extreme care when inserting a spoon or other utensil into the container.
20. Clean ventilation openings and grease filters frequently—grease should not be allowed to accumulate on ventilation openings, louver or grease filters.
21. Use care when cleaning the louver and the grease filters. Corrosive cleaning agents, such as lye-based oven cleaners, may damage the louver and the grease filters.
22. When flaming food under the hood, turn the fan on.
23. This appliance is suitable for use above both gas and electric cooking equipment 36” wide or less.

SAVE THESE INSTRUCTIONS

24. When using the convection or combination cooking functions, both the outside and inside of the oven will become hot. Always use hot pads to remove containers of food and cooking accessories such as the oven shelf, round wire rack and glass tray.

25. Do not clean with metal scouring pads. Pieces can burn off the pad and touch electrical parts involving risk of electric shock.

Open the bottom of the carton, bend the carton flaps back and tilt the oven over to rest on plastic foam pad. Lift carton off oven and remove all packing materials, WALL and TOP CABINET TEMPLATES. SAVE THE CARTON AS IT MAY MAKE INSTALLATION EASIER.

1. Remove the feature sticker from the outside of the door, if there is one.
2. Check to see that there is a WALL TEMPLATE and TOP CABINET TEMPLATE. Read enclosures and SAVE the Use and Care Guide.

Check the oven for any damage, such as misaligned or bent door, damaged door seals and sealing surfaces, broken or loose door hinges and latches and dents inside the cavity or on the door. If there is any damage, do not operate the oven and contact your dealer or ELECTROLUX AUTHORIZED SERVICER. See Installation Instructions for more details.

26. *Thermometer*—Do not use regular cooking or oven thermometers when cooking by microwave or combination. The metal and mercury in these thermometers could cause arcing and possible damage to the oven. Do not use a thermometer in food you are microwaving unless the thermometer is designed or recommended for use in the microwave oven.

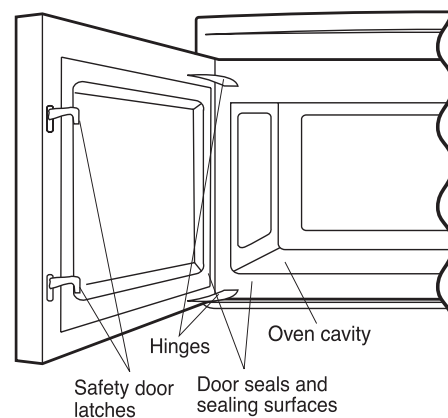

⚠ WARNING

If you see arcing, press the **Stop/Clear** button and correct the problem.

ARCING

Arcing is the microwave term for sparks in the oven. Arcing is caused by:

- The metal shelf not installed correctly so it touches the microwave wall.
- Metal or foil touching the side of the oven.
- Foil not molded to food (upturned edges act like antennas).
- Metal, such as twist-ties, poultry pins, or gold-rimmed dishes, in the microwave.
- Recycled paper towels containing small metal pieces being used in the microwave.

Federal Communications Commission Radio Frequency Interference Statement (U.S.A. Only)

This equipment generates and uses ISM frequency energy and if not installed and used properly, that is in strict accordance with the manufacturer's instructions, may cause interference to radio and television reception. It has been type tested and found to comply with limits for ISM Equipment pursuant to part 18 of FCC Rules, which are designed to provide reasonable protection against such interference in a residential installation.

However, there is no guarantee that interference will not occur in a particular installation. If this equipment does cause interference to radio or television reception, which can be determined by turning the equipment off and on, the user is encouraged to try to correct the interference by one or more of the following:

- Reorient the receiving antenna of the radio or television.
- Relocate the microwave oven with respect to the receiver.
- Move the microwave oven away from the receiver.
- Plug the microwave oven into a different outlet so that the microwave oven and the receiver are on different branch circuits.

The manufacturer is not responsible for any radio or television interference caused by unauthorized modification to this microwave oven. It is the responsibility of the user to correct such interference.

6 GROUNDING INSTRUCTIONS

This appliance must be grounded. This oven is equipped with a cord having a grounding wire with a grounding plug. It must be plugged into a wall receptacle that is properly installed and grounded in accordance with the National Electrical Code and local codes and ordinances. In the event of an electrical short circuit, grounding reduces risk of electric shock by providing an escape wire for the electric current.



WARNING

Improper use of the grounding plug can result in a risk of electric shock.

Electrical Requirements

The oven is equipped with a 3-prong grounding plug. **DO NOT UNDER ANY CIRCUMSTANCES CUT OR REMOVE THE GROUNDING PIN FROM THE PLUG.**

DO NOT USE AN EXTENSION CORD.

If the power supply cord is too short, have a qualified electrician or serviceman install an outlet near the appliance.

The Power Supply Cord and plug must be connected to a separate 120 Volt AC, 60 Hz, 15 Amp, or more branch circuit, single grounded receptacle. The receptacle should be located inside the cabinet directly above the Microwave Oven mounting location as shown in Figure 1.

NOTES:

1. If you have any questions about the grounding or electrical instructions, consult a qualified electrician or service person.
2. Neither Electrolux nor the dealer can accept any liability for damage to the oven or personal injury resulting from failure to observe the correct electrical connection procedures.

Radio or TV Interference

Should there be any interference caused by the microwave oven to your radio or TV, check that the microwave oven is on a different electrical circuit, relocate the radio or TV as far away from the oven as feasible or check position and signal of receiving antenna.

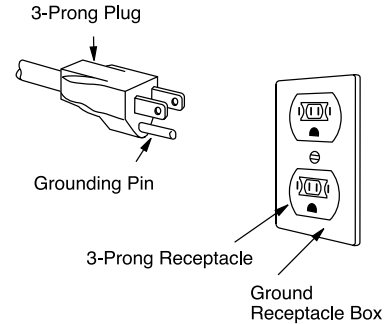
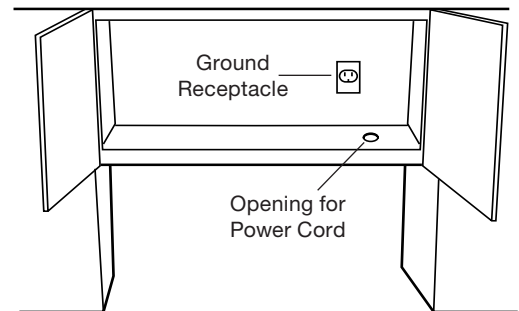

Figure 1



About Your Oven

This Use and Care Guide is valuable: read it carefully and always save it for reference.

NEVER use the oven without the turntable and support nor turn the turntable over so that a large dish could be placed in the oven. The turntable will turn both clockwise and counterclockwise.

ALWAYS have food in the Microwave Oven when it is on to absorb the microwave energy.

When using the oven at power levels below 100%, you may hear the magnetron cycling on and off. It is normal for the exterior of the oven to be warm to the touch when cooking or reheating.

Condensation is a normal part of microwave cooking. Room humidity and the moisture in food will influence the amount of moisture that condenses in the oven. Generally, covered foods will not cause as much condensation as uncovered ones. Ventilation openings must not be blocked.

The Microwave Oven is for food preparation only. It should not be used to dry clothes or newspapers.

Your Microwave Oven is rated 1050 watts by using the IEC Test Procedure. In using recipes or package directions, check food a minute or two before the minimum time and add time accordingly.

About Microwave Cooking

- Arrange food carefully. Place thickest areas towards outside of dish.
- Watch cooking time. Cook for the shortest amount of time indicated and add more as needed. Food severely overcooked can smoke or ignite.
- Cover foods while cooking. Check recipe or cookbook for suggestions: paper towels, wax paper, microwave plastic wrap or a lid. Covers prevent spattering and help foods to cook evenly.
- Shield with small flat pieces of aluminum foil any thin areas of meat or poultry to prevent overcooking before dense, thick areas are cooked thoroughly.
- Stir foods from outside to center of dish once or twice during cooking, if possible.
- Turn foods over once during microwaving to speed cooking of such foods as chicken and hamburgers. Large items like roasts must be turned over at least once.
- Rearrange foods such as meatballs halfway through cooking both from top to bottom and from the center of the dish to the outside.
- Add standing time. Remove food from oven and stir, if possible. Cover for standing time which allows the food to finish cooking without overcooking.
- Check for doneness. Look for signs indicating that cooking temperatures have been reached.
Doneness signs include:
 - Food steams throughout, not just at edge.
 - Center bottom of dish is very hot to the touch.
 - Poultry thigh joints move easily.
 - Meat and poultry show no pinkness.
 - Fish is opaque and flakes easily with a fork.

About Safety

- Check foods to see that they are cooked to the United States Department of Agriculture's recommended temperatures.

Temp	Food
145°F (63°C)	For beef, lamb or veal cut into steaks chops or roasts MEDIUM RARE
160°F (71°C)	For fresh pork, ground meat, fish, seafood, egg dishes, frozen prepared food and beef, lamb or veal cut into steaks, chops or roasts cooked to MEDIUM
165°F (74°C)	For leftover, ready-to-reheat refrigerated, deli and carry out "fresh" food, whole chicken or turkey, chicken or turkey breasts and ground poultry used in chicken or turkey burgers, boneless white poultry. NOTE: Do not cook whole, stuffed poultry. Cook stuffing separately to 165°F.

To test for doneness, insert a meat thermometer in a thick or dense area away from fat or bone. NEVER leave the thermometer in the food during cooking, unless it is approved for microwave use.

- ALWAYS use potholders to prevent burns when handling utensils that are in contact with hot food. Enough heat from the food can transfer through utensils to cause skin burns.
- Avoid steam burns by directing steam away from the face and hands. Slowly lift the farthest edge of a dish's covering and carefully open popcorn and oven cooking bags away from the face.
- Stay near the oven while it's in use and check cooking progress frequently so that there is no chance of overcooking food.
- NEVER use the cavity for storing cookbooks or other items.
- Select, store and handle food carefully to preserve its high quality and minimize the spread of foodborne bacteria.
- Keep waveguide cover clean. Food residue can cause arcing and/or fires.
- Use care when removing items from the oven so that the utensil, your clothes or accessories do not touch the safety door latches.
- Keep aluminum foil used for shielding at least 1 inch away from walls, ceiling and door.

About Children and the Microwave

Children below the age of 7 should use the microwave oven with a supervising person very near to them. Between the ages of 7 and 12, the supervising person should be in the same room.

The child must be able to reach the oven comfortably; if not, he/she should stand on a sturdy stool.

At no time should anyone be allowed to lean or swing on the oven door.

Children should be taught all safety precautions: use potholders, remove coverings carefully, pay special attention to packages that crisp food because they may be extra hot.

Don't assume that because a child has mastered one cooking skill he/she can cook everything.

Children need to learn that the microwave oven is not a toy. See page 21 for Child Lock feature.

About Food

Food	Do	Don't
Eggs, sausages, nuts, seeds, fruits & vegetables	<ul style="list-style-type: none"> • Puncture egg yolks before cooking to prevent “explosion”. • Pierce skins of potatoes, apples, squash, hot dogs and sausages so that steam escapes. 	<ul style="list-style-type: none"> • Cook eggs in shells. • Reheat whole eggs. • Dry nuts or seeds in shells.
Popcorn	<ul style="list-style-type: none"> • Use specially bagged popcorn for microwave cooking. • Listen while popping corn for the popping to slow to 1 or 2 seconds or use special popcorn pad. 	<ul style="list-style-type: none"> • Pop popcorn in regular brown bags or glass bowls. • Exceed maximum time on popcorn package.
Baby food	<ul style="list-style-type: none"> • Transfer baby food to small dish and heat carefully, stirring often. Check temperature before serving. • Put nipples on bottles after heating and shake thoroughly. “Wrist” test before feeding. 	<ul style="list-style-type: none"> • Heat disposable bottles. • Heat bottles with nipples on. • Heat baby food in original jars.
General	<ul style="list-style-type: none"> • Cut baked goods with filling after heating to release steam and avoid burns. • Stir liquids briskly before and after heating to avoid “eruption”. • Use deep bowl, when cooking liquids or cereals, to prevent boilovers. 	<ul style="list-style-type: none"> • Heat or cook in closed glass jars or air tight containers. • Can in the microwave as harmful bacteria may not be destroyed. • Deep fat fry. • Dry wood, gourds, herbs or wet papers.

About Utensils and Coverings

It is not necessary to buy all new cookware. Many pieces already in your kitchen can be used successfully in your new Over the Range Microwave Oven. Make sure the utensil does not touch the interior walls during cooking.

Use these utensils for safe microwave cooking and reheating:

- glass ceramic (Pyroceram®), such as Corningware®.
- heat-resistant glass (Pyrex®)
- microwave-safe plastics
- paper plates
- microwave-safe pottery, stoneware and porcelain
- browning dish (Do not exceed recommended preheating time. Follow manufacturer's directions.)

These items can be used for short time reheating of foods that have little fat or sugar in them:

- wood, straw, wicker

DO NOT USE

- metal pans and bakeware
- dishes with metallic trim
- non-heat-resistant glass
- non-microwave-safe plastics (margarine tubs)
- recycled paper products
- brown paper bags
- food storage bags
- metal twist-ties

Should you wish to check if a dish is safe for microwaving, place the empty dish in the oven and microwave on HIGH for 30 seconds. A dish which becomes very hot should not be used.

The following coverings are ideal:

- Paper towels are good for covering foods for reheating and absorbing fat while cooking bacon.
- Wax paper can be used for cooking and reheating.
- Plastic wrap that is specially marked for microwave use can be used for cooking and reheating. DO NOT allow plastic wrap to touch food. Vent so steam can escape.
- Lids that are microwave-safe are a good choice because heat is kept near the food to hasten cooking.
- Oven cooking bags are good for large meats or foods that need tenderizing. DO NOT use metal twist ties. Remember to slit bag so steam can escape.

How to use aluminum foil in your Over the Range Microwave Oven:

- Small flat pieces of aluminum foil placed smoothly on the food can be used to shield areas that are either defrosting or cooking too quickly.
- Foil should not come closer than one inch to any surface of the oven.



Should you have questions about utensils or coverings, check a good microwave cookbook or follow recipe suggestions.

Accessories

There are many microwave accessories available for purchase. Evaluate carefully before you purchase so that they meet your needs. A microwave-safe thermometer will assist you in determining correct doneness and assure you that foods have been cooked to safe temperatures. Electrolux is not responsible for any damage to the oven when accessories are used.

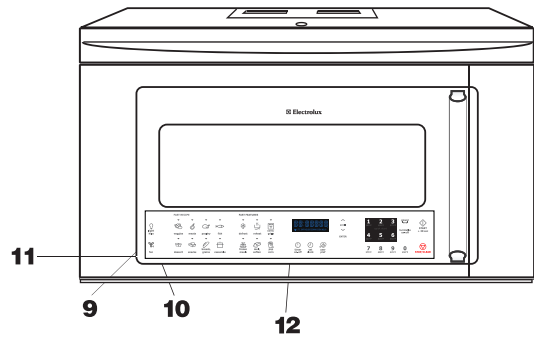
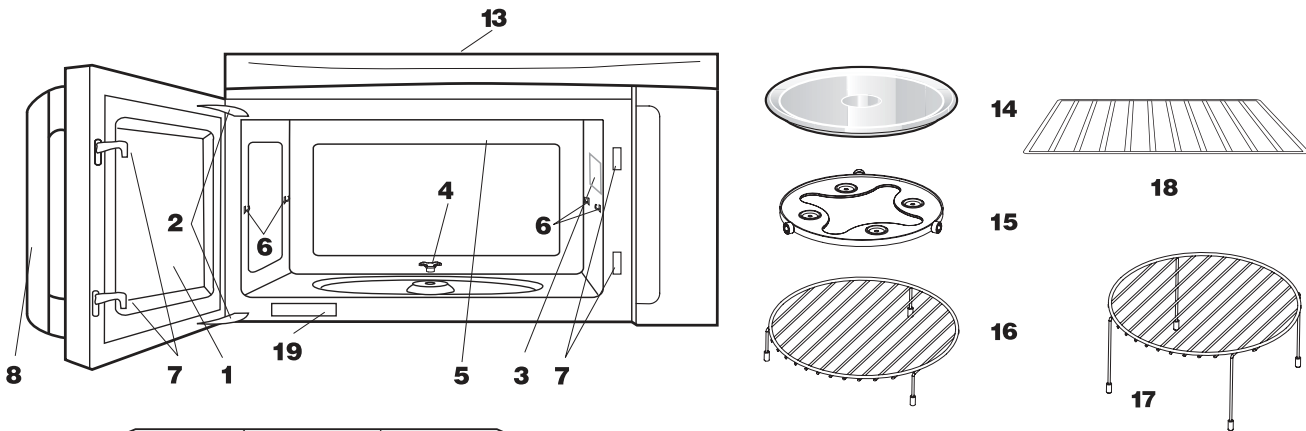
FRONT VIEW



- 1 Microwave oven door with see-through window
- 2 Door hinges
- 3 Waveguide cover:
DO NOT REMOVE.
- 4 Turntable motor shaft
- 5 Microwave oven light
It will light when microwave oven is operating or door is open.
- 6 Metal rack holders
- 7 Safety door latches
The microwave oven will not operate unless the door is securely closed.
- 8 Handle
- 9 Light hi lo pad 
Press **light** once for high, twice for light low, three times for light off.
- 10 Vent turbo/hi/med/lo/off pad 
Press **fan** once for fan speed turbo, twice for fan speed high, three times for fan speed medium, four times for fan speed low, five times for fan speed off.
- 11 Auto-Touch control panel
- 12 Time display: Digital display, 99 minutes, 99 seconds
- 13 Ventilation openings
- 14 Removable turntable glass
Position glass tray on turntable motor shaft coupling.

- 15 Removable turntable support
Install the turntable support on the microwave oven bottom, centering the turntable support around the turntable coupling. Then place the turntable glass tray unto the turntable motor coupling.
- 16 Low wire rack
use for convection and combination cooking. Place on glass turntable tray for proper operation.
- 17 High wire rack
use for convection and combination cooking. Place on glass turntable tray for proper operation.
- 18 Wire metal tray for cooking multiple levels of food.
- 19 Rating label (model and serial number)

Accessories

The accessories 16 and 17 are designed especially for use in the microwave oven for convection, mix or broil cooking. **DO NOT USE FOR MICROWAVE ONLY COOKING.** Do not substitute similar types of racks for these specially designed ones.

High wire rack (Baking rack)—for convection and fast bake.

- This rack is placed on the turntable for two-level cooking, such as layer cakes, muffins, etc.

Low wire rack (Broiling rack)—for convection, broiling or fast roast.

- Place on the turntable and use for roasting or broiling to allow juices to drain away from food.

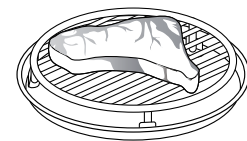
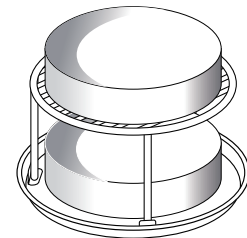

Number next to the control panel illustration indicates pages on which there are feature descriptions and usage information.

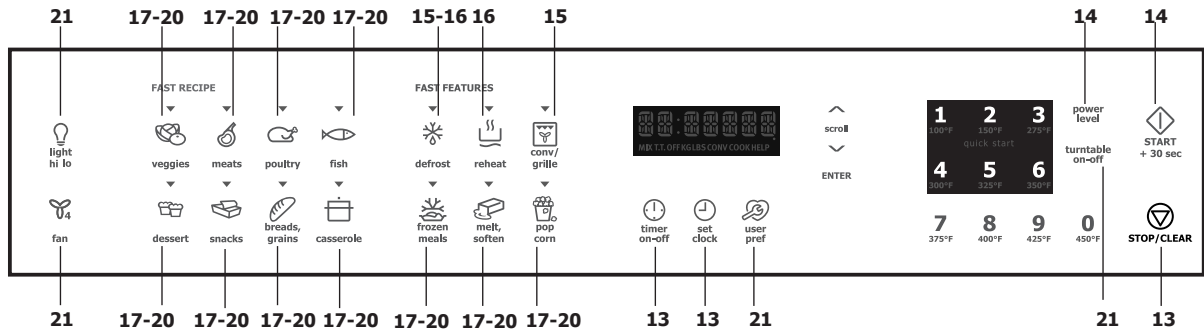

Words in the lower portion of the display will light to indicate what function is in progress.

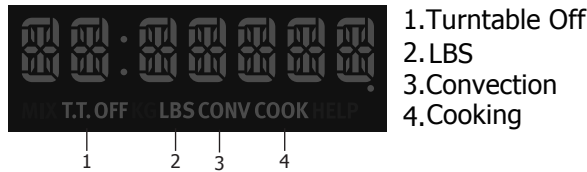

Refer to the menu label for quick references.

<i>Veggies</i>	<i>Meats</i>	<i>Poultry</i>
<ol style="list-style-type: none"> baked potato baked sweet potato broccoli-cheese gratin candied sweet potatoes canned veggies chinese hot & sour soup creamy vegetable soup fresh veggies frozen veggies garlic roasted peppers herbed potato fans potato, tomato & onion casserole rosemary garlic potatoes wilted spinach with bacon 	<ol style="list-style-type: none"> american meatloaf barbecued babyback ribs beef rib roast chili rubbed ham steak creole pork chops flank steak ground meat hamburgers herbed spare ribs hot dogs korean style sirloin steak maple glazed pork tenderloin southwestern burgers spinach stuffed pork chops 	<ol style="list-style-type: none"> barbecued chicken buffalo chicken wings caribbean chicken kabobs chicken breasts chicken nuggets northern Italian cornish hens rosemary roasted chicken scrambled eggs
		<i>Defrost</i>
		<ol style="list-style-type: none"> casserole chicken pieces ground beef roast soup steaks/chops/fish
<i>Fish</i>	<i>Desserts</i>	<i>Snacks</i>
<ol style="list-style-type: none"> fish/seafood flounder with sherry oven fried fish spicy salmon steaks scrod with garlic bread crumbs shrimp 	<ol style="list-style-type: none"> chocolate chip cookies chocolate decadence cookies cranberry-orange relish cupcakes fudge brownies lemon cookies lemon custard bars New England baked apples oatmeal raisin cookies pecan crisps 	<ol style="list-style-type: none"> appetizers finger foods frozen/fresh sandwich hand held foods pizza bites pizza fresh pizza frozen soup
<i>Breads, grains</i>	<i>Casserole</i>	<i>Melt, Soften</i>
<ol style="list-style-type: none"> croissants fresh rolls/muffins frozen french toast frozen rolls/muffins hot cereal pasta rice tomato-spinach risotto 	<ol style="list-style-type: none"> beef stroganoff casserole chicken and rice chicken pot pie lemon and shrimp risotto oven roasted meatballs with pasta pasta with tomato meat sauce pasta with tomatoes & broccoli rabe seafood pasta tuna noodle casserole vegetarian medley white chicken chili 	<ol style="list-style-type: none"> butter chocolate cream Cheese ice Cream
		<i>Frozen meals</i>
		<ol style="list-style-type: none"> dinner plate frozen breakfast frozen entrees frozen kids meal

Before operating your new Convection Microwave Oven make sure you read and understand this Use and Care Guide completely.

Before the Convection Microwave Oven can be used, follow these procedures:

1. After unit is installed above range, make sure the unit is plugged into the electrical outlet.
2. Close the door. The oven display will show PLEASE SET TIME OF DAY.. This will repeat for 3 times in the display. Then unit will beep and [:] will appear in display.
3. You can set the clock anytime during this time. See instructions on setting the clock below.

1.To Set the Clock

- Suppose you want to enter the correct time of day 2:30 .

Procedure	
Step	Touch

1. Press the **set clock** pad.



2. Enter the correct time of day by pressing the numbers in sequence.

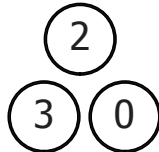

The display will show 2:30

3. Press the **START / +30sec** pad to confirm.



NOTE

1. This is a 12 hour clock.
2. After the setting clock, the oven will display the current time.
3. During the setting clock, if you don't confirm the clock by pressing **START / +30sec** in 5 minutes or press **STOP/CLEAR**, the clock is invalid and oven will display ":".
4. If clock has not been set and no operation occurs in 5 minutes, the oven will go into the power saving mode and the display will not be lit. To light, touch any pad on the control panel to go out of the power saving mode.

2.Stop/Clear

Touch the **STOP/CLEAR** to:

1. Erase if you make a mistake during programming.
2. Stop the oven temporarily during cooking.
3. Return the time of day to the display.
4. Cancel a program during cooking, touch twice.
5. To turn back to the waiting state, when "END" or "COOK END" is displayed.

3.Timer Function

1. Press **timer on-off** .
2. Press number keys to input the cooking time you need. The maximum cooking time is 99 minutes and 99 seconds.
3. Press **timer on-off** to start time count down. When countdown time has expired, the buzzer will sound and "END" is displayed to indicate completion.
4. Either open up the door or touch **Stop / Clear** pad to turn back to the waiting state.

NOTE

1. When timer is counting down and you want to cancel timer touch the **Timer on-off** pad to cancel.
2. When timer function is in use, hood fan and surface light can be activated.
3. Timer can be set in the cooking and pause state. And the display will show the remaining cooking time. You can press **timer on-off** to check timer.

- Suppose you want to time a 3-minute long distance phone call.

Procedure	
Step	Touch

1. Press the **timer on-off** pad.



2. Enter time.

The display will show 3:00



3. Press the **timer on-off** pad. The timer will count down.



4. Setting Microwave for Manual Cooking

4.1 Setting your microwave to cook

The Over the Range Microwave Oven can be programmed for 99 minutes 99seconds (99:99). Press number keys (not only 1 to 6) to set the cooking time, then press **START / +30sec** to start the oven of cooking time set at 100% power.

- Suppose you want to cook 10 minutes at 100% power.

Procedure	
Step	Touch

1. Press number key 1,0,0,0.

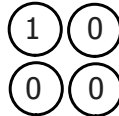

Note: After pressing the first number key, the next number must be pressed quickly (within 2 seconds). This is for using numbers 1-6 as the first digit pressed, as these are also used as a quick start cooking feature. Refer to section 4.2 below.

2. Press **START / +30sec** to start the oven of 10 minutes at 100% power.



4.2 Quick Start

1. Quick start is very useful function to start to cook from 1 minute to 6 minutes by pressing number from 1 to 6.
- Suppose you want to cook 2 minutes at 100% power.

Procedure	
Step	Touch

Press number 2 and oven will automatically start cooking for 2 minutes.



2. Press **START / +30sec** pad to start to cook for 30 seconds at 100% power. You can press the **START / +30sec** pad multiple times to keep adding on more cook time.

- Suppose you want to heat a cup of soup for 30 seconds.

Procedure	
Step	Touch

Press the **START / +30sec** pad .



During cooking, 30 seconds of the cook time can be added by pressing the **START / +30sec** pad. The pad can be pressed multiple times to keep adding more cook time to program.

4.3 Setting microwave cooking by setting power and cooking time

To Set Power Level

There are ten preset power levels. Using lower power levels increases the cooking time which is recommended for foods such as cheese, milk and long slow cooking of meats. Consult cookbook or recipes for specific recommendations

During the microwave cooking, the power can be changed. Press **power level**, the current power will light, now you can press number key to change the power.

Example: press 8 to change power to P-80, and the display remind "**THE CURRENT POWER LEVEL IS P-80**". The power of the remaining time will be 80%.

PRESS POWER LEVEL and PAD NUMBER FOR DESIRED POWER	APPROXIMATE PERCENTAGE OF POWER	COMMON WORDS FOR POWER LEVELS
PAD NUMBER 1,0	100%(P-100)	High
PAD NUMBER 9	90%(P- 90)	
PAD NUMBER 8	80%(P- 80)	
PAD NUMBER 7	70% (P- 70)	Medium High
PAD NUMBER 6	60%(P- 60)	
PAD NUMBER 5	50%(P- 50)	Medium
PAD NUMBER 4	40%(P- 40)	
PAD NUMBER 3	30%(P- 30)	Med Low/Defrost
PAD NUMBER 2	20%(P- 20)	
PAD NUMBER 1	10%(P- 10)	Low

- Suppose you want to cook for 5 minutes at 80% power level.

Procedure	
Step	Touch

1. Press number keys to select the cooking time .
2. Press **power level** key once. The default power is P-100
3. Press number 8 to set the power. For example: 10 for 100% power, 1 for 10%power

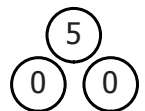

4. Press the **START / +30sec** pad to start the oven. And the cooking time counts down.



NOTE

After the cooking is finished, the unit will beep 4 times and the display will show "Cook End". To cancel this, either open up the door or touch **Stop / Clear** pad.





5. Convection / Grille Cooking

5.1 Convection

There are ten temperatures of convection: 100°F, 150°F, 275°F, 300°F, 325°F, 350°F, 375°F, 400°F, 425°F, 450°F.

Using conv/grille with preheating

Suppose you want to preheat the oven and then cook food for 5 minutes at 275°F using convection.

Procedure	
Step	Touch
1. Press conv/grille pad once.	
2. Press number/temperature keys to select temperature.	3 275°F
3. Press START / +30sec pad to confirm.	
4. Press START / +30sec key to start preheating the oven. The display will show the preheat temperature. When the temperature set is reached, the beeper will sound 4 times and display will show "PREHEAT END" to remind you to place food in the oven.	
5. Open the door, place food into the oven. Then press the number keys 5,0,0.	5 0 0
6. Press the START / +30sec pad to start the oven.	

Using conv/grille without preheating

- Suppose you want to cook food for 5 minutes at 275°F using convection without preheating

Procedure	
Step	Touch
1. Put food into the oven. Press conv/grille pad once.	

- Press number/temperature keys to select temperature.

3
275°F

- Press **START / +30sec** pad to confirm.



- Press number keys to select cooking time. The maximum time is 99 minutes and 99 seconds.

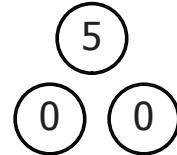



- Press the **START / +30sec** pad to start the oven



5.2 Grille

- Suppose you want to cook food for 5 minutes using grille.

Procedure	
Step	Touch
1. Press conv/grille pad twice.	
2. Press number keys to select cooking time. The maximum time is 99 minutes and 99 seconds.	5 0 0
3. Press the START / +30sec pad the oven.	

NOTES

- During convection cooking, the vent fan will automatically turn on at the low speed setting to protect the microwave oven. The vent fan will automatically turn off once the convection cooking is completed (after approximately 60 seconds)
- If baking with temperatures above 300F the vent fan will automatically turn on at medium speed after a period of time

6. Setting Defrost

Procedure	
Step	Touch
1. Press defrost pad once.	

16 MANUAL COOKING

- Press scroll " \wedge , \vee " or numeric keys to select the menu.
- Press **Enter** key to confirm
- Use the numeric keys to select the weight.
- Press **START / +30sec** to start defrosting







Number key	Defrost menu	Range of weight/portion
1	casserole	2~6 cups
2	chicken pieces	0.5~3.0 lbs
3	ground beef	0.5~3.0 lbs
4	roast	2.0~4.0 lbs
5	soup	1~6 cups
6	steaks/chops/fish	0.5~4.0 lbs

- Suppose you want to defrost 3.0 lbs chicken pieces.

Procedure

Step	Touch
------	-------



- Press **defrost** pad. 
- Press scroll " \wedge , \vee " or number 2 to select the menu. 
- Press **Enter** key to confirm 
- Use the numeric keys to select the weight. 
- Press **START / +30sec** key to start cooking. 

7.Sensor Reheat

- Suppose you want to reheat.

Procedure

Step	Touch
------	-------

- Press the **reheat** pad. The weight range of reheat menu is 8-16 oz. 
- Press the **START / +30sec.** The oven will start cooking. 

NOTES

- After oven buzzer twice, the display will count down the cooking time. When cooking has finished, the display will show "COOK END".
- Before oven buzzer twice, if you press **STOP/CLEAR** open the oven door, the sensor function stop and oven will turn back to the waiting state.

8.Multiple Sequence Cooking





Your oven can be programmed for up to 2 automatic cooking sequences, switching from one power level setting to another automatically.

Sometimes cooking directions tell you to start on one power level and then change to a different power level. Your oven can do this automatically.

- Suppose you want to cook beef rib roast for 5 minutes at 100% and then continue to cook for 30 minutes at 50%.

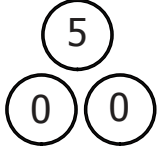
Procedure

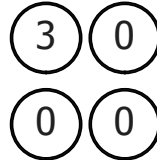
Step	Touch
------	-------

- Enter cooking time for 1st stage. 
- Press the **power level** pad then press number 10 for 100% power for 1st stage. 
- Press **Enter** key to confirm 
- Enter second cooking time for 2nd stage. 
- Press the **power level** pad then number 5 for 50% power for 2nd stage. 
- Press the **START / +30sec** pad start the first stage cooking. When the first stage finishes, the buzzer will sound twice and the second stage will begin cooking. 

NOTES



1. Only microwave, grille /convection cooking can be programmed for multi-stage cooking. Defrost and Auto programs cannot be set for multi-stage cooking.
2. If the 1st state is grille /convection cooking and the 2nd is microwave cooking, between the two stage programme setting, **ENTER** should be pressed, then set the 2nd cooking time.

9.Auto Cook



The oven has a number of auto cook recipes that will help you to select the right programs. Including frozen meals,melt soften,popcorn, veggies,meats,poultry,fish,dessert,snacks, bread(grains),casserole.You can do the following: There are many selections to choose from which are listed on pages 18 - 20.

- Suppose you want to cook veggies.





Procedure	
Step	Touch

1. Press **veggies** pad once. 
2. Press scroll "**^**," **∨**" or numeric keys to select the menu.
Ex:Press number key 1 for baked potato or press scroll key "**^**"one time for baked potato, and the display remind "TOUCH START".
3. Press **START / +30sec** key to start cooking 

For some menus (Refer to the Fast Recipe Chart in Pages 18-20 with the * before the menu), after selecting the menu in 2nd step, the display will remind you to "Touch Enter".Then



3. Press **ENTER** key to confirm the menu selected. 
4. use the numeric keys to select the weight.
5. Press **START / +30sec** key to start cooking 

- Suppose you want to cook 4.0lbs beef rib roast.

Procedure	
Step	Touch
1. Press meats pad once.	
2. Press scroll " ^ ," ∨ " or numeric keys to select the menu. Ex:Press number key 3 for beef rib roast or press scroll key " ^ "one time for beef rib roast	
3. Press Enter pad to confirm.	
4. use the numeric keys to select the weight. Ex: touch 1 to select 3.0lbs,touch 2 to select 4.0lbs,	
5. Press START / +30sec key to start cooking	

Popcorn

- Suppose you want to cook popcorn of 3.5, 3.0 or 1.75 oz.

Procedure	
Step	Touch
1. Press popcorn pad once.	
2. Press number keys 1-3 to select the weight.	
3. Press START / +30sec pad.	

Function (Key)	Menu	Range of Weight/Servings
Veggies	** 1.baked potato	1~4 potatos
	2.baked sweet potato	4 Servings
	3.broccoli-cheese gratin	4 Servings
	4.candied sweet potatoes	4 Servings
	** 5.canned veggies	1~2 cans
	6.chinese hot & sour soup	8 Servings
	7.creamy vegetable soup	6 Servings
	** 8.fresh veggies	4~16 OZ
	** 9.frozen veggies	6~16 OZ
	10.garlic roasted peppers	8 Servings
	11.herbed potato fans	8 Servings
	12.potato, tomato & onion casserole	6 Servings
	13.rosemary garlic potatoes	4 Servings
	14.wilted spinach with bacon	4 Servings
Meats	1.american meatloaf	8 Servings
	2.barbecued babyback ribs	4 Servings
	* 3.beef rib roast	3.0,4.0 lbs
	4.chili rubbed ham steak	4 Servings
	5.creole pork chops	4 Servings
	6.flank steak	4 Servings
	** 7.ground meat	8~24 OZ
	* 8.hamburgers	1,2,3,4 each
	9.herbed spare ribs	4 Servings
	* 10.hot dogs	1,2,3,4 each
	11.korean style sirloin steak	4 Servings
	12.maple glazed pork tenderloin	6 Servings
	13.southwestern burgers	4 Servings
	14.spinach stuffed pork chops	4 Servings
Poultry	1.barbecued chicken	4 Servings
	2.buffalo chicken wings	15 appetizers
	3.carribbean chicken kabobs	4 Servings
	** 4.chicken breasts	4~16OZ
	* 5.chicken nuggets	8,12,16,20,24 OZ
	6.Northern Italian cornish hens	4 Servings
	7.rosmary roasted chicken	4 Servings
	8.scrambled eggs	1 egg

Function (Key)	Menu	Range of Weight/Servings
Fish	** 1.fish/seafood	4~16OZ
	2.flounder with sherry	4 Servings
	3.oven fried fish	4 Servings
	4.spicy salmon steaks	4 Servings
	5.scrod with garlic bread crumbs	4 Servings
	6.shrimp	4 Servings
Desserts	1.chocolate chip cookies	18*2 cookies
	2.chocolate decadence cookies	12*2 cookies
	3.cranberry-orange relish	3 cups
	4.cupcakes	12 cupcakes
	5.fudge brownies	16 brownies
	6.lemon cookies	30*2 cookies
	7.lemon custard bars	24 bars
	8.New England baked apples	4 Servings
	9.oatmeal raisin cookies	14*2 cookies
	10.pecan crisps	14*2 cookies
Snacks	* 1.appetizers	1,2,3,4 serving
	* 2.finger foods	1,2 Servings
	* 3.frozen/fresh sandwich	1,2,3 each
	* 4.hand held foods	1,2 servings
	* 5.pizza bites	1,2 servings
	* 6.pizza fresh	4,8,16 OZ
	** 7.pizza frozen	6~12 OZ
	* 8.soup	1,2,3,4 cups
Breads,grains	* 1.croissants	1,2,3,4,5,6 each
	* 2.fresh rolls/muffins	1,2,3,4,5,6 each
	* 3.frozen french toast	2,4 servings
	* 4.frozen rolls/muffins	1,2,3,4,5,6 each
	* 5.hot cereal	1,2,3,4,5,6 servings
	** 6.pasta	8~24OZ
	** 7.rice	1~2Cups
	8.tomato-spinach risotto	4 servings

Function (Key)	Menu	Range of Weight/Servings
Casseroles	1.beef stroganoff	4 Servings
	* 2.casserole	1,2,3,4 cups
	3.chicken and rice	3 Servings
	4.chicken pot pie	8 Servings
	5.lemon and shrimp risotto	4 Servings
	6.oven roasted meatballs with pasta	6 Servings
	7.pasta with tomato meat sauce	6 Servings
	8.pasta with tomatoes & broccoli rabe	4 Servings
	9.seafood pasta	3 Servings
	10.tuna noodle casserole	4 Servings
	11.vegetarian medley	3 Servings
	12.white chicken chili	4 Servings
Melt,Soften	* 1.butter	2 tbsps,0.25 cup,0.5 cup
	* 2.chocolate	1,2 cups
	* 3.cream cheese	3,6,8 OZ
	* 4.ice cream	4,8,16,32 OZ
Frozen meals	** 1.dinner plate	8~16OZ
	* 2.frozen breakfast	4,6,8 OZ
	** 3.frozen entrees	8~24OZ
	* 4.frozen kids meal	1,2 Servings
Popcom		3.5,3.0,1.75 OZ

 **NOTES**

- 1.The auto menu with * should press ENTER and numeric keys to select the weight.
- 2.The auto menu with ** are sensor menu items. The food in the listed weight range will be cooked automatically.

10. Vent Fan

1. When the exhaust fan is off, press **fan** once for fan speed turbo.
2. Press **fan** twice for fan speed high
3. Press **fan** three times for fan speed medium.
4. Press **fan** four times for fan speed low.
5. Press **fan** five times for fan speed off.

11. Light

1. Press **light** once for light high.
2. Press **light** twice for light low.
3. Press **light** three times for light off.

12. Enquire

1. During microwave cooking state, press **power level** to check the power level and the remaining cooking time will display after 10 seconds.
2. During cooking, pause or timer state, press **set clock** to check the clock.

13. User Pref

User Pref provides 5 features that make using your oven easy because specific instructions are provided in the interactive display.

User Pref Label

user pref

- | | |
|---|--------------------------|
| 1 | child lock on/off |
| 2 | demo on/off |
| 3 | sound on/off |
| 4 | scroll speed |
| 5 | website |

1. child lock on/off

The Child Lock prevents unwanted oven operation such as by small children. The oven can be set so that the control panel is deactivated or locked. First, Press the **user pref** pad, the number 1 pad . To set, press the number 1 pad. To cancel, press the number 2 pad.

2. demo on/off

Press the **user pref** pad, the number 2 pad, then you can set the demo by pressing number 1. To cancel, press the number 2 pad.

3. sound on/off

Press the **user pref** pad, the number 3 pad, then you can set the sound by pressing number 1. To cancel, press the number 2 pad.

4. scroll speed

Press the **user pref** pad, the number 4 pad, then you can set the scroll speed by pressing number 1 to 3. Press number 1 for slow, number 2 for normal, number 3 for fast.

5. website

Press the **user pref** pad, the number 5 pad, then you can see the website "WWW.ELECTROLUX.COM"

14. Turntable on-off

1. Press **turntable on-off** key once for turntable off.
2. Press **turntable on-off** key twice for turntable on.

NOTES

This function only can be used on microwave function.

Disconnect the power cord before cleaning or leave the door open to deactivate the oven during cleaning.

EXTERIOR

The outside surface is precoated steel and plastic. Clean the outside with mild soap and water; rinse and dry with a soft cloth. Do not use any type of household or abrasive cleaner.

DOOR

Disconnect the power cord or deactivate the oven with setting Child Lock before cleaning to prevent unexpected manipulation. See Child Lock on page 21. Wipe the window on both sides with a soft cloth to remove any spills or splatters. Metal parts will be easier to maintain if wiped frequently with a soft cloth. Avoid the use of spray and other harsh cleaners as they may stain, streak or dull the door surface.

EASY CARE™ STAINLESS STEEL (SOME MODELS)

Your microwave oven finish may be made with Easy Care™ Stainless Steel (some models). Clean the stainless with warm soapy water using a clean sponge or cloth. Rinse with clean water and dry with a soft clean cloth. **DO NOT** use ANY store bought cleaners like Stainless Steel cleaners or any other types of cleaners containing any abrasive, chlorides, chlorines or ammonia. It is recommended to use mild dish soap and water or a 50/50 solution of water and vinegar.

INTERIOR

Cleaning is easy because little heat is generated to the interior surfaces; therefore, there is no baking and setting of spills or spattering. To clean the interior surfaces, wipe with a soft cloth and warm water. **DO NOT USE ABRASIVE OR HARSH CLEANERS OR SCOURING PADS.** For heavier soil, use baking soda or a mild soap; rinse thoroughly with hot water. The rack can be cleaned with hot soapy water, rinsed and dried.

WAVEGUIDE COVER

The waveguide cover is located on the ceiling in the microwave oven cavity. It is made from mica so requires special care. Keep the waveguide cover clean to assure good microwave oven performance. Carefully wipe with a damp cloth any food splatters from the surface of the cover immediately after they occur. Built-up splashes may overheat and cause smoke or possibly catch fire. **DO NOT REMOVE THE WAVEGUIDE COVER.**

ODOR REMOVAL

Occasionally, a cooking odor may remain in the microwave oven. To remove, combine 1 cup water, grated peel and juice of 1 lemon and several whole cloves in a 2-cup glass measuring cup. Boil for several minutes using 100% power. Allow to set in microwave oven until cool. Wipe interior with a soft cloth.

TURNTABLE/TURNTABLE SUPPORT

The turntable and turntable support can be removed for easy cleaning. Wash them in mild, sudsy water; for stubborn stains use a mild cleanser and non-abrasive scouring sponge. They are also dishwasher-proof. Use upper rack of dishwasher. The turntable motor shaft is not sealed, so excess water or spills should be wiped up immediately.

GREASE FILTERS

Filters should be cleaned at least once a month. Never operate the fan or microwave oven without the filters in place.

1. Pull down slightly on the tab toward the front of the microwave oven and remove the filter. Repeat for the other filter.
2. Soak the filters in a sink or dish pan filled with hot water and detergent. **DO NOT** use ammonia or other alkali; they will react with the filter material and darken it.
3. Agitate and scrub with a brush to remove embedded dirt.
4. Rinse thoroughly and shake dry.
5. Replace by fitting the filter back into the opening.

BOTTOM VIEW

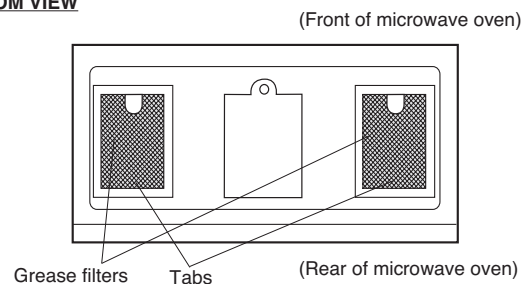

Disconnect the power cord before cleaning or leave the door open to deactivate the oven during cleaning.

Cleaning the exhaust filters

The oven ventilation exhaust filters should be removed and cleaned often; generally at least once every month.

CAUTION

To avoid risk of personal injury or property damage, do not operate oven hood without filters properly in place.

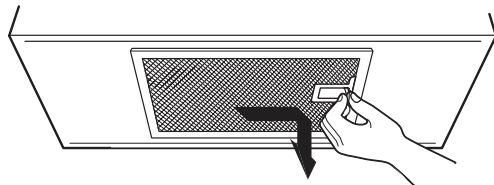
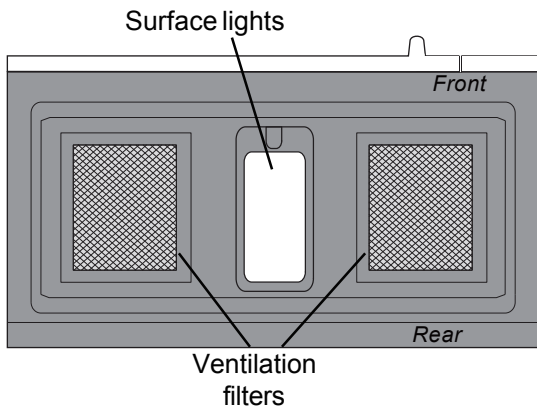

1. To remove the exhaust ventilation filters, pull the lever, then pull filter downward. The filter will drop out. Repeat for the 2nd filter.

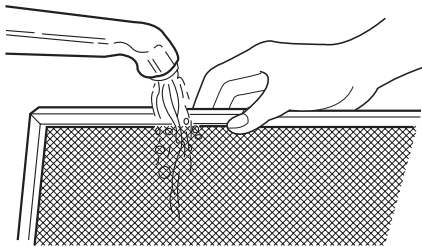

2. Soak the ventilation filters in hot water using a mild detergent. Rinse well and shake to dry. or wash ventilation filters in dishwasher. It is best to place in upper rack of dishwasher for cleaning.

NOTES

Do not use ammonia cleaner. The ammonia cleaner may corrode and darken the aluminum on the filter.

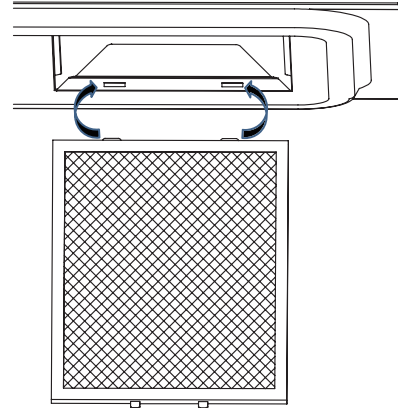

3. To reinstall the exhaust ventilation filter, infix the hooks into the holes of base plate, then pull the lever and toward oven to lock. Reinstall the 2nd filter using the same procedure.

Surface light replacement

CAUTION

To avoid risk of personal injury or property damage, wear gloves when replacing the light bulbs.

1. Unplug the microwave oven or turn off power at the main circuit breaker.
2. Remove the bulb cover mounting screws at light positions under the microwave.

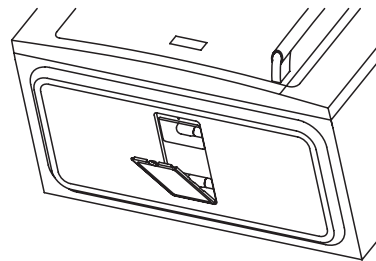

3. Replace bulb with 40 watt appliance bulb.
4. Re-install bulb cover and mounting screw.
5. Plug the microwave back into the power supply or turn the power back on at the main circuit breaker.

Disconnect the power cord before cleaning or leave the door open to deactivate the oven during cleaning.

Charcoal filter replacement

Charcoal Filter installed in your microwave oven, is used for non vented, recirculated installation. The filter should be changed every 6 to 12 months depending on use.

1. Disconnect power to the microwave oven at the circuit breaker panel or by unplugging.
2. Remove the vent grill mounting screws.
3. Pull the vent grill away from the unit.

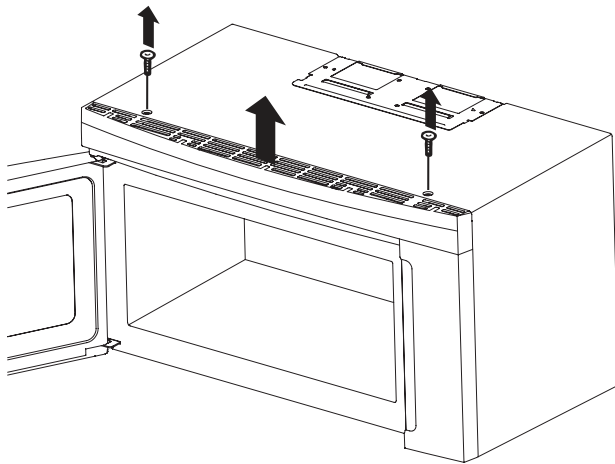

4. Remove the charcoal filter by pushing it inwards, then turn and pull it away from the unit.

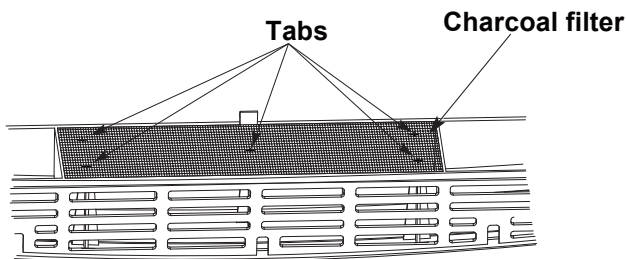

Oven light replacement

Remove the vent grill per instructions 1-4 above and charcoal filter, if used.

1. Open light cover by carefully loosening the screw on the front edge.

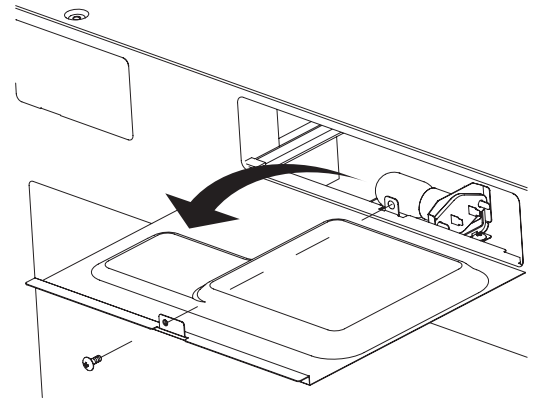

2. Remove burnt out light bulb and replace only with an equivalent 40 watt bulb available from parts distributor. Bulbs are also available at most hardware stores or lighting centers.

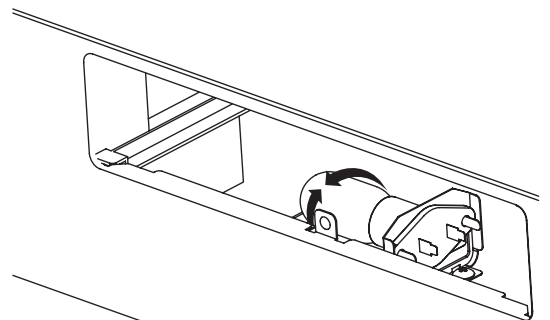

Note: DO NOT USE BULB LARGER THAN 40WATTS.

3. Replace the microwave oven light cover by carefully pushing into place. Replace the charcoal filter. Push the vent grill back into place (engaging both the bottom and top tabs) and replace the vent grill mounting screws.

Please check the following before calling for service:

Place one cup of water in a glass measuring cup in the oven and close the door securely.

Operate the oven for one minute at HIGH 100%.

- A Does the microwave oven light come on? YES _____ NO _____
- B Does the cooling fan work? (Put your hand at top above Display.) YES _____ NO _____
- C Does the turntable rotate? (It is normal for the turntable to turn in either direction.) YES _____ NO _____
- D Is the water in the microwave oven warm? YES _____ NO _____

If “NO” is the answer to any of the above questions, please check electrical outlet, fuse and/or circuit breaker. If they are functioning properly, CONTACT YOUR NEAREST ELECTROLUX AUTHORIZED SERVICER.

A microwave oven should never be serviced by a “do-it-yourself” repair person.

NOTES

1. If time appearing in the display is counting down very rapidly, check Demonstration Mode on page 21 and cancel.
2. If the oven is set for 40 minutes and over at 80, 90 or 100 percent power level, after the first 40 minutes the power level will automatically adjust itself to 70 percent power to avoid overcooking.

PLEASE READ CAREFULLY BEFORE USE TO UNDERSTAND VENT FAN AUTOMATIC OPERATION

PLEASE BE AWARE THAT THESE CONDITIONS CAN NOT BE CHANGED AND ARE TO BE EXPECTED AS NORMAL OPERATION

No.	Condition	Guideline	Press Stop/Clear or Cooking Ends	Comments
1	Convection	The vent fan will turn on at low speed when the convection cycle starts	Vent fan continues on low speed for 60 seconds, then it will stop	
2	Convection	If the setting temperature is 300-450F, when the temperature reaches the set temperature, the vent fan will automatically come on at the medium speed to cool the unit	Vent fan continues on medium speed for 60 seconds, then it will stop	If the setting temperature is \geq 300F, the vent fan will automatically come on during the cooking cycle. If during the cycle the STOP/CLEAR key is pressed or cycle is ended the vent fan will remain on for an additional 60 seconds
3	Grill	If the grill program time is \geq 10 minutes, the vent fan will automatically turn on to medium speed to cool the unit	Vent fan continues on medium speed for 60 seconds, then it will stop	
4	Microwave 100% + vent fan (turbo speed) + cooktop light on high	In using the microwave with the cooktop light on high, the maximum vent speed will be high. If Turbo speed is selected, it will automatically change to high speed		
5	All Condition	The vent fan will automatically start when heat rises from range surface units or burners. This protects the Over The Range Microwave Oven from excessive heat from the cooktop. The vent fan will stay on until the temperature decreases. The vent fan cannot be turned off manually during this time		

SPECIFICATIONS

AC Line Voltage:	Single phase 120V, 60Hz, AC only
AC Power Required:	1500 W 15 amps. (for EI30BM6CPS)
Output Power*:	900 watts
Output Power:*(convection):	1500 watts
Frequency:	2450 MHz (Group 2/Class B)**
Outside Dimensions (including handle):	29.88 "(W) x 17.56 "(H) x 17.06 "(D)
Cavity Dimensions:	21.25 "(W) x 9.94 "(H) x 14.72 "(D)
Microwave Oven Capacity***:	1.8 Cu. Ft.
Weight:	Approx. (net) 69.5 lb, (gross) 84.5 lb
Work/Night Light:	2 bulbs 40w each (incandescent light bulbs)
Oven Light:	1 bulb 40w (incandescent light bulbs)

* The International Electrotechnical Commission's standardized method for measuring output wattage. This test method is widely recognized.

** This is the classification of ISM (Industrial, Scientific and Medical) equipment described in the International Standard CISPR11. (for EI30BM5CH)

*** Internal capacity is calculated by measuring maximum width, depth and height. Actual capacity for holding food is less.

In compliance with standards set by:

FCC - Federal Communications Commission Authorized.

DHHS - Complies with Department of Health and Human Services (DHHS) rule, CFR, Title 21, Chapter I, Subchapter J.



- This symbol on the nameplate means the product is listed by Underwriters Laboratories, Inc.

Major Appliance Warranty Information

Your appliance is covered by a one year limited warranty. For one year from your original date of purchase, Electrolux will repair or replace any parts of this appliance that prove to be defective in materials or workmanship when such appliance is installed, used, and maintained in accordance with the provided instructions. In addition, the magnetron tube of your appliance is covered by a two through five year limited warranty. During the 2nd through 5th years from your original date of purchase, Electrolux will provide a replacement magnetron tube for your appliance which has proven to be defective in materials or workmanship when your appliance is installed, used, and maintained in accordance with the provided instructions.

Exclusions

This warranty does not cover the following:

1. Products with original serial numbers that have been removed, altered or cannot be readily determined.
2. Product that has been transferred from its original owner to another party or removed outside the USA or Canada.
3. Rust on the interior or exterior of the unit.
4. Products purchased "as-is" are not covered by this warranty.
5. Food loss due to any refrigerator or freezer failures.
6. Products used in a commercial setting.
7. Service calls which do not involve malfunction or defects in materials or workmanship, or for appliances not in ordinary household use or used other than in accordance with the provided instructions.
8. Service calls to correct the installation of your appliance or to instruct you how to use your appliance.
9. Expenses for making the appliance accessible for servicing, such as removal of trim, cupboards, shelves, etc., which are not a part of the appliance when it is shipped from the factory.
10. Service calls to repair or replace appliance light bulbs, air filters, water filters, other consumables, or knobs, handles, or other cosmetic parts.
11. Labor or in-home service costs during the additional limited warranty periods beyond the first year from your original date of purchase.
12. Pickup and delivery costs; your appliance is designed to be repaired in the home.
13. Surcharges including, but not limited to, any after hour, weekend, or holiday service calls, tolls, ferry trip charges, or mileage expense for service calls to remote areas, including the state of Alaska.
14. Damages to the finish of appliance or home incurred during transportation or installation, including but not limited to floors, cabinets, walls, etc.
15. Damages caused by: services performed by unauthorized service companies; use of parts other than genuine Electrolux parts or parts obtained from persons other than authorized service companies; or external causes such as abuse, misuse, inadequate power supply, accidents, fires, or acts of God.

DISCLAIMER OF IMPLIED WARRANTIES; LIMITATION OF REMEDIES

CUSTOMER'S SOLE AND EXCLUSIVE REMEDY UNDER THIS LIMITED WARRANTY SHALL BE REPAIR OR REPLACEMENT AS PROVIDED HEREIN. **CLAIMS BASED ON IMPLIED WARRANTIES, INCLUDING WARRANTIES OF MERCHANTABILITY OR FITNESS FOR A PARTICULAR PURPOSE, ARE LIMITED TO ONE YEAR OR THE SHORTEST PERIOD ALLOWED BY LAW, BUT NOT LESS THAN ONE YEAR.** ELECTROLUX SHALL NOT BE LIABLE FOR CONSEQUENTIAL OR INCIDENTAL DAMAGES SUCH AS PROPERTY DAMAGE AND INCIDENTAL EXPENSES RESULTING FROM ANY BREACH OF THIS WRITTEN LIMITED WARRANTY OR ANY IMPLIED WARRANTY. SOME STATES AND PROVINCES DO NOT ALLOW THE EXCLUSION OR LIMITATION OF INCIDENTAL OR CONSEQUENTIAL DAMAGES, OR LIMITATIONS ON THE DURATION OF IMPLIED WARRANTIES, SO THESE LIMITATIONS OR EXCLUSIONS MAY NOT APPLY TO YOU. THIS WRITTEN WARRANTY GIVES YOU SPECIFIC LEGAL RIGHTS. YOU MAY ALSO HAVE OTHER RIGHTS THAT VARY FROM STATE TO STATE.

If You Need Service

Keep your receipt, delivery slip, or some other appropriate payment record to establish the warranty period should service be required. If service is performed, it is in your best interest to obtain and keep all receipts. Service under this warranty must be obtained by contacting Electrolux at the addresses or phone numbers below.

This warranty only applies in the USA, Puerto Rico and Canada. In the USA and Puerto Rico, your appliance is warranted by Electrolux Major Appliances North America, a division of Electrolux Home Products, Inc. In Canada, your appliance is warranted by Electrolux Canada Corp. Electrolux authorizes no person to change or add to any obligations under this warranty. Obligations for service and parts under this warranty must be performed by Electrolux or an authorized service company. Product features or specifications as described or illustrated are subject to change without notice.

USA

1-877-435-3287

Electrolux Home Products, Inc.,
10200 David Taylor Drive
Charlotte, NC 28262

Canada

1-800-265-8352

Electrolux Canada Corp.
5855 Terry Fox Way
Mississauga, Ontario, Canada L5V 3E4

