



CONTENTS

1. SAFETY INFORMATION.....	2
2. SAFETY INSTRUCTIONS.....	4
3. PRODUCT DESCRIPTION.....	6
4. BEFORE FIRST USE.....	7
5. DAILY USE.....	7
6. USING THE ACCESSORIES.....	8
7. ADDITIONAL FUNCTIONS.....	9
8. HINTS AND TIPS.....	9
9. CARE AND CLEANING.....	21
10. TROUBLESHOOTING.....	23
11. ENERGY EFFICIENCY.....	24
12. WARRANTY.....	25

WE'RE THINKING OF YOU

Thank you for purchasing an Electrolux appliance. You've chosen a product that brings with it decades of professional experience and innovation. Ingenious and stylish, it has been designed with you in mind. So whenever you use it, you can be safe in the knowledge that you'll get great results every time.

Welcome to Electrolux.

Visit our website for:



Get usage advice, brochures, trouble shooter, service information:

www.electrolux.com/webselfservice



Register your product for better service:

www.registerelectrolux.com



Buy Accessories, Consumables and Original spare parts for your appliance:

www.electrolux.com/shop

CUSTOMER CARE AND SERVICE

Always use original spare parts.

When contacting our Authorised Service Centre, ensure that you have the following data available: Model, PNC, Serial Number.

The information can be found on the rating plate.

 Warning / Caution-Safety information

 General information and tips

 Environmental information

Subject to change without notice.

1. SAFETY INFORMATION

Before the installation and use of the appliance, carefully read the supplied instructions. The manufacturer is not

responsible for any injuries or damages that are the result of incorrect installation or usage. Always keep the instructions in a safe and accessible location for future reference.

1.1 Children and vulnerable people safety

- This appliance can be used by children aged from 8 years and above and persons with reduced physical, sensory or mental capabilities or lack of experience and knowledge if they have been given supervision or instruction concerning the use of the appliance in a safe way and understand the hazards involved.
- Do not let children play with the appliance.
- Keep all packaging away from children and dispose of it appropriately.
- Keep children and pets away from the appliance when it operates or when it cools down. Accessible parts are hot.
- If the appliance has a child safety device, this should be activated.
- Children shall not carry out cleaning and user maintenance of the appliance without supervision.
- Children aged 3 years and under must be kept away from this appliance when it is in operation at all times.

1.2 General Safety

- Only a qualified person must install this appliance and replace the cable.
- **WARNING:** The appliance and its accessible parts become hot during use. Care should be taken to avoid touching heating elements. Children less than 8 years of age shall be kept away unless continuously supervised.
- Always use oven gloves to remove or put in accessories or ovenware.
- Before maintenance cut the power supply.

- Ensure that the appliance is switched off before replacing the lamp to avoid the possibility of electric shock.
- Do not use a steam cleaner to clean the appliance.
- Do not use harsh abrasive cleaners or sharp metal scrapers to clean the glass door since they can scratch the surface, which may result in shattering of the glass.
- If the mains power supply cable is damaged, it must be replaced by the manufacturer, its Authorised Service Centre or similarly qualified persons to avoid an electrical hazard.
- To remove the shelf supports first pull the front of the shelf support and then the rear end away from the side walls. Install the shelf supports in the opposite sequence.

2. SAFETY INSTRUCTIONS

2.1 Installation



WARNING!

Only a qualified person must install this appliance.

- Remove all the packaging.
- Do not install or use a damaged appliance.
- Follow the installation instruction supplied with the appliance.
- Always take care when moving the appliance as it is heavy. Always use safety gloves and enclosed footwear.
- Do not pull the appliance by the handle.
- Keep the minimum distance from the other appliances and units.
- Make sure that the appliance is installed below and adjacent safe structures.
- The sides of the appliance must stay adjacent to appliances or to units with the same height.

2.2 Electrical connection



WARNING!

Risk of fire and electrical shock.

- All electrical connections should be made by a qualified electrician.
- The appliance must be earthed.
- Make sure that the electrical information on the rating plate agrees with the power supply. If not, contact an electrician.
- Always use a correctly installed shockproof socket.
- Do not use multi-plug adapters and extension cables.
- Make sure not to cause damage to the mains plug and to the mains cable. Should the mains cable need to be replaced, this must be carried out by our Authorised Service Centre.
- Do not let mains cables touch or come near the appliance door, especially when the door is hot.
- The shock protection of live and insulated parts must be fastened in such a way that it cannot be removed without tools.

- Connect the mains plug to the mains socket only at the end of the installation. Make sure that there is access to the mains plug after the installation.
- If the mains socket is loose, do not connect the mains plug.
- Do not pull the mains cable to disconnect the appliance. Always pull the mains plug.
- Use only correct isolation devices: line protecting cut-outs, fuses (screw type fuses removed from the holder), earth leakage trips and contactors.
- The electrical installation must have an isolation device which lets you disconnect the appliance from the mains at all poles. The isolation device must have a contact opening width of minimum 3 mm.
- This appliance complies with the E.E.C. Directives.
- Do not put flammable products or items that are wet with flammable products in, near or on the appliance.

**WARNING!**

Risk of damage to the appliance.

- To prevent damage or discoloration to the enamel:
 - do not put ovenware or other objects in the appliance directly on the bottom.
 - do not put aluminium foil directly on the bottom of the appliance.
 - do not put water directly into the hot appliance.
 - do not keep moist dishes and food in the appliance after you finish the cooking.
 - be careful when you remove or install the accessories.
- Discoloration of the enamel has no effect on the performance of the appliance.
- Use a deep pan for moist cakes. Fruit juices cause stains that can be permanent.
- This appliance is for cooking purposes only. It must not be used for other purposes, for example room heating.
- Always cook with the oven door closed.
- If the appliance is installed behind a furniture panel (e.g. a door) make sure the door is never closed when the appliance is in operation. Heat and moisture can build up behind a closed furniture panel and cause subsequent damage to the appliance, the housing unit or the floor. Do not close the furniture panel until the appliance has cooled down completely after use.

2.3 Use

**WARNING!**

Risk of injury, burns and electrical shock or explosion.

- This appliance is for household use only.
- Do not change the specification of this appliance.
- Make sure that the ventilation openings are not blocked.
- Do not let the appliance stay unattended during operation.
- Deactivate the appliance after each use.
- Be careful when you open the appliance door while the appliance is in operation. Hot air can release.
- Do not operate the appliance with wet hands or when it has contact with water.
- Do not apply pressure on the open door.
- Do not use the appliance as a work surface or as a storage surface.
- Open the appliance door carefully. The use of ingredients with alcohol can cause a mixture of alcohol and air.
- Do not let sparks or open flames to come in contact with the appliance when you open the door.

2.4 Care and cleaning

**WARNING!**

Risk of injury, fire, or damage to the appliance.

- Before maintenance, deactivate the appliance and disconnect the mains plug from the mains socket.

- Make sure the appliance is cold. There is the risk that the glass panels can break.
- Replace immediately the door glass panels when they are damaged. Contact the Authorised Service Centre.
- Be careful when you remove the door from the appliance. The door is heavy!
- Clean regularly the appliance to prevent the deterioration of the surface material.
- Clean the appliance with a moist soft cloth. Only use neutral detergents. Do not use any abrasive products, abrasive cleaning pads, solvents or metal objects.
- If you use an oven spray, obey the safety instructions on the packaging.
- Do not clean the catalytic enamel (if applicable) with any kind of detergent.

2.5 Internal light

- The type of light bulb or halogen lamp used for this appliance is only for household appliances. Do not use it for house lighting.



WARNING!
Risk of electrical shock.

- Before replacing the lamp, disconnect the appliance from the power supply.
- Only use lamps with the same specifications.

2.6 Disposal



WARNING!
Risk of injury or suffocation.

- Disconnect the appliance from the mains supply.
- Cut off the mains electrical cable close to the appliance and dispose of it.
- Remove the door catch to prevent children or pets from becoming trapped in the appliance.

2.7 Service

- To repair the appliance contact an Authorised Service Centre.
- Use original spare parts only.

3. PRODUCT DESCRIPTION

3.1 General overview

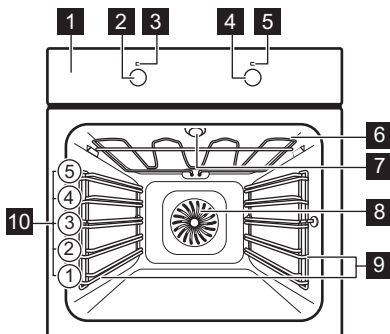

- 1 Control panel
- 2 Knob for the oven functions
- 3 Power lamp / symbol
- 4 Knob for the temperature
- 5 Temperature indicator / symbol
- 6 Heating element
- 7 Lamp
- 8 Fan
- 9 Shelf support, removable
- 10 Shelf positions

3.2 Accessories

Wire shelf

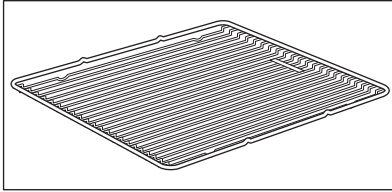

For cookware, cake tins, roasts.

Baking tray

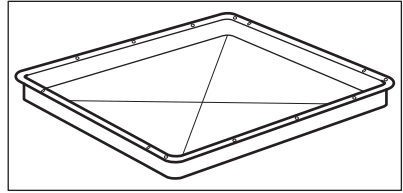

For cakes and biscuits.

4. BEFORE FIRST USE



WARNING!
Refer to Safety chapters.

4.1 Initial Cleaning

Remove all accessories and removable shelf supports from the appliance.



Refer to "Care and cleaning" chapter.

Clean the appliance and the accessories before first use.

Put the accessories and the removable shelf supports back to their initial position.

5. DAILY USE



WARNING!
Refer to Safety chapters.

5.1 Retractable knobs

To use the appliance, press the control knob. The control knob comes out.

5.2 Activating and deactivating the appliance











It depends on the model if your appliance has lamps, knob symbols or indicators:

- The lamp comes on when the appliance operates.
- The symbol shows whether the knob controls the oven functions or the temperature.
- The indicator comes on when the oven heats up.

1. Turn the knob for the oven functions to select an oven function.
2. Turn the knob for the temperature to select a temperature.
3. To deactivate the appliance turn the knobs for the oven functions and temperature to the off position.

5.3 Oven functions

Oven function	Application	
0	Off position	The appliance is off.
	Light	To activate the lamp without a cooking function.
	True Fan Cooking	To bake on up to three shelf positions at the same time and to dry food. Set the temperature 70 - 100 °F lower than for Top / Bottom Heat.
	Pizza Setting	To bake food on one shelf position for a more intensive browning and a crispy bottom. Set the temperature 70 - 100 °F lower than for Top / Bottom Heat.
	Top / Bottom Heat	To bake and roast food on one shelf position.
	Bottom Heat	To bake cakes with crispy bottom and to preserve food.
	Defrost	This function can be used for defrosting frozen foods, such as vegetables and fruits. The defrosting time depends on the amount and size of the frozen food.
	Grilling	To grill flat food and to toast bread.
	Fast Grilling	To grill flat food in large quantities and to toast bread.
	Turbo Grilling	To roast larger meat joints or poultry with bones on one shelf position. Also to make gratins and to brown.

6. USING THE ACCESSORIES



WARNING!
Refer to Safety chapters.

6.1 Inserting the accessories

Wire shelf:

Push the shelf between the guide bars of the shelf support and make sure that the feet point down.

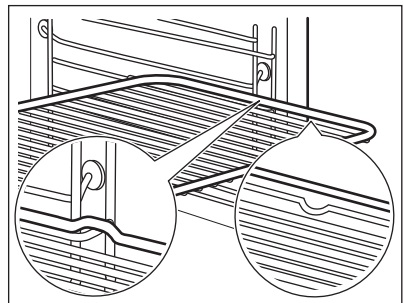

Baking tray:

Push the baking tray between the guide bars of the shelf support.

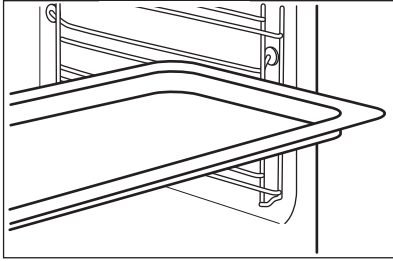

Wire shelf and baking tray together:

Push the baking tray between the guide bars of the shelf support and the wire shelf on the guide bars above.

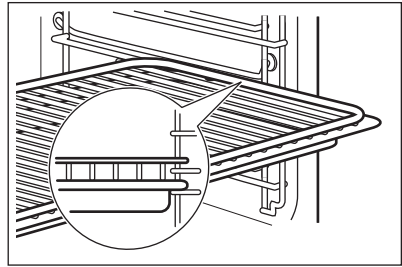

Small indentation at the top increase safety. The indentations are also anti-tip devices. The high rim around the shelf prevents cookware from slipping.

7. ADDITIONAL FUNCTIONS

7.1 Cooling fan

When the appliance operates, the cooling fan activates automatically to keep the surfaces of the appliance cool.

If you deactivate the appliance, the cooling fan can continue to operate until the appliance cools down.

8. HINTS AND TIPS



WARNING!
Refer to Safety chapters.



The temperature and baking times in the tables are guidelines only. They depend on the recipes and the quality and quantity of the ingredients used.

8.1 Baking

- Your oven may bake or roast differently to the appliance you had before. Adapt your usual settings (temperature, cooking times) and shelf positions to the values in the tables.
- The manufacturer recommends that you use the lower temperature the first time.

- If you cannot find the settings for a special recipe, look for the one that is almost the same.
- You can extend baking times by 10 – 15 minutes if you bake cakes on more than one shelf position.
- Cakes and pastries at different heights do not always brown equally at first. If this occurs, do not change the temperature setting. The differences equalize during the baking procedure.
- With longer baking times, you can deactivate the oven approximately 10 minutes before the end of the baking time and then use the residual heat.

When you cook frozen food, the trays in the oven can twist during baking. When the trays become cold again, the distortions are gone.

8.2 Tips on baking

Baking results	Possible cause	Remedy
The bottom of the cake is not browned sufficiently.	The shelf position is incorrect.	Put the cake on a lower shelf.
The cake sinks and becomes soggy, lumpy or streaky.	The oven temperature is too high.	The next time you bake, set a slightly lower oven temperature.
The cake sinks and becomes soggy, lumpy or streaky.	The baking time is too short.	Set a longer baking time. You cannot decrease baking times by setting higher temperatures.
The cake sinks and becomes soggy, lumpy or streaky.	There is too much liquid in the mixture.	Use less liquid. Be careful with mixing times, especially if you use a mixing machine.
The cake is too dry.	The oven temperature is too low.	The next time you bake, set a higher oven temperature.
The cake is too dry.	The baking time is too long.	The next time you bake, set a shorter baking time.
The cake browns unevenly.	The oven temperature is too high and the baking time is too short.	Set a lower oven temperature and a longer baking time.
The cake browns unevenly.	The mixture is unevenly distributed.	Spread the mixture evenly on the baking tray.
The cake is not ready in the baking time given.	The oven temperature is too low.	The next time you bake, set a slightly higher oven temperature.

8.3 Baking on one level:

Baking in tins

Food	Function	Temperature (°F)	Time (min)	Shelf position
Ring cake or brioche	True Fan Cooking	300 - 320	50 - 70	1
Madeira cake / fruit cakes	True Fan Cooking	280 - 320	70 - 90	1
Fatless sponge cake / Fatless sponge cake	True Fan Cooking	280 - 300	35 - 50	2

Food	Function	Temperature (°F)	Time (min)	Shelf position
Fatless sponge cake / Fatless sponge cake	Top / Bottom Heat	320	35 - 50	2
Flan base - short pastry	True Fan Cooking	340 - 360 ¹⁾	10 - 25	2
Flan base - sponge mixture	True Fan Cooking	300 - 340	20 - 25	2
Apple pie / Apple pie (2tins Ø20cm, diagonally off set)	True Fan Cooking	320	60 - 90	2
Apple pie / Apple pie (2tins Ø20cm, diagonally off set)	Top / Bottom Heat	360	70 - 90	1
Cheesecake	Top / Bottom Heat	340 - 380	60 - 90	1

¹⁾ Preheat the oven.

Cakes / pastries / breads on baking trays

Food	Function	Temperature (°F)	Time (min)	Shelf position
Plaited bread / bread crown	Top / Bottom Heat	340 - 380	30 - 40	3
Christmas stollen	Top / Bottom Heat	320 - 360 ¹⁾	50 - 70	2
Bread (rye bread): 1. First part of baking process. 2. Second part of baking process.	Top / Bottom Heat	1. 450 ¹⁾ 2. 320 - 360	1. 20 2. 30 - 60	1
Cream puffs / eclairs	Top / Bottom Heat	380 - 410 ¹⁾	20 - 35	3
Swiss roll	Top / Bottom Heat	360 - 400 ¹⁾	10 - 20	3
Cake with crumble topping (dry)	True Fan Cooking	300 - 320	20 - 40	3

Food	Function	Temperature (°F)	Time (min)	Shelf position
Buttered almond cake / sugar cakes	Top / Bottom Heat	380 - 410 ¹⁾	20 - 30	3
Fruit flans (made with yeast dough / sponge mixture) ²⁾	True Fan Cooking	300	35 - 55	3
Fruit flans (made with yeast dough / sponge mixture) ²⁾	Top / Bottom Heat	340	35 - 55	3
Fruit flans made with short pastry	True Fan Cooking	320 - 340	40 - 80	3
Yeast cakes with delicate toppings (e.g. quark, cream, custard)	Top / Bottom Heat	320 - 360 ¹⁾	40 - 80	3

1) Preheat the oven.

2) Use a deep pan.

Biscuits

Food	Function	Temperature (°F)	Time (min)	Shelf position
Short pastry biscuits	True Fan Cooking	300 - 320	10 - 20	3
Short bread / Short bread / Pastry Stripes	True Fan Cooking	280	20 - 35	3
Short bread / Short bread / Pastry Stripes	Top / Bottom Heat	320 ¹⁾	20 - 30	3
Biscuits made with sponge mixture	True Fan Cooking	300 - 320	15 - 20	3
Pastries made with egg white, meringues	True Fan Cooking	180 - 210	120 - 150	3

Food	Function	Temperature (°F)	Time (min)	Shelf position
Macaroons	True Fan Cooking	210 - 250	30 - 50	3
Biscuits made with yeast dough	True Fan Cooking	300 - 320	20 - 40	3
Puff pastries	True Fan Cooking	340 - 360 ¹⁾	20 - 30	3
Rolls	True Fan Cooking	320 ¹⁾	10 - 25	3
Rolls	Top / Bottom Heat	380 - 410 ¹⁾	10 - 25	3
Small cakes / Small cakes (20 per tray)	True Fan Cooking	300 ¹⁾	20 - 35	3
Small cakes / Small cakes (20 per tray)	Top / Bottom Heat	340 ¹⁾	20 - 30	3

¹⁾ Preheat the oven.

8.4 Bakes and gratins

Food	Function	Temperature (°F)	Time (min)	Shelf position
Pasta bake	Top / Bottom Heat	360 - 400	45 - 60	1
Lasagne	Top / Bottom Heat	360 - 400	25 - 40	1
Vegetables au gratin ¹⁾	Turbo Grilling	320 - 340	15 - 30	1
Baguettes topped with melted cheese	True Fan Cooking	320 - 340	15 - 30	1
Sweet bakes	Top / Bottom Heat	360 - 400	40 - 60	1
Fish bakes	Top / Bottom Heat	360 - 400	30 - 60	1
Stuffed vegetables	True Fan Cooking	320 - 340	30 - 60	1

¹⁾ Preheat the oven.

8.5 Multilevel Baking

Use the function True Fan Cooking.

Cakes / pastries / breads on baking trays

Food	Temperature (°F)	Time (min)	Shelf position	
			2 positions	3 positions
Cream puffs / Eclairs	320 - 360 ¹⁾	25 - 45	1 / 4	-
Dry streusel cake	300 - 320	30 - 45	1 / 4	-

1) Preheat the oven.

Biscuits / small cakes / small cakes / pastries / rolls

Food	Temperature (°F)	Time (min)	Shelf position	
			2 positions	3 positions
Short pastry biscuits	300 - 320	20 - 40	1 / 4	1 / 3 / 5
Short bread / Short bread / Pastry Stripes	280	25 - 45	1 / 4	1 / 3 / 5
Biscuits made with sponge mixture	320 - 340	25 - 40	1 / 4	-
Biscuits made with egg white, meringues	180 - 210	130 - 170	1 / 4	-
Macaroons	210 - 250	40 - 80	1 / 4	-
Biscuits made with yeast dough	320 - 340	30 - 60	1 / 4	-
Puff pastries	340 - 360 ¹⁾	30 - 50	1 / 4	-
Rolls	360	20 - 30	1 / 4	-
Small cakes / Small cakes (20 per tray)	300 ¹⁾	23 - 40	1 / 4	-

1) Preheat the oven.

8.6 Pizza Setting

Food	Temperature (°F)	Time (min)	Shelf position
Pizza (thin crust)	400 - 450 ¹⁾²⁾	15 - 20	2

Food	Temperature (°F)	Time (min)	Shelf position
Pizza (with a lot of topping)	360 - 400	20 - 30	2
Tarts	360 - 400	40 - 55	1
Spinach flan	320 - 360	45 - 60	1
Quiche Lorraine	340 - 380	45 - 55	1
Swiss flan	340 - 380	45 - 55	1
Apple cake, covered	300 - 340	50 - 60	1
Vegetable pie	320 - 360	50 - 60	1
Unleavened bread	450 - 480 ¹⁾	10 - 20	2
Puff pastry flan	320 - 360 ¹⁾	45 - 55	2
Flammekuchen (Pizza-like dish from Alsace)	450 - 480 ¹⁾	12 - 20	2
Piroggen (Russian version of calzone)	360 - 400 ¹⁾	15 - 25	2

1) Preheat the oven.

2) Use a deep pan.

8.7 Roasting

- Use heat-resistant ovenware to roast (refer to the instructions of the manufacturer).
- You can roast large roasting joints directly in the deep pan (if present) or on the wire shelf above the deep pan.
- Roast lean meats in the roasting tin with the lid. This keeps the meat more succulent.
- All types of meat that can be browned or have crackling can be roasted in the roasting tin without the lid.
- We recommend that you cook meat and fish weighing 1 kg and above in the appliance.
- To prevent the meat juices or fat from burning onto the pan, put some liquid into the deep pan.
- If necessary, turn the roast (after 1/2 - 2/3 of the cooking time).
- Baste large roasts and poultry with their juices several times during roasting. This gives better roasting results.
- You can deactivate the appliance approximately 10 minutes before the end of the roasting time, and use the residual heat.

8.8 Roasting tables

Beef

Food	Quantity	Function	Temperature (°F)	Time (min)	Shelf position
Pot roast	1 - 1.5 kg	Top / Bottom Heat	450	120 - 150	1
Roast beef or fillet: rare	per cm of thickness	Turbo Grilling	380 - 400 ¹⁾	5 - 6	1
Roast beef or fillet: medium	per cm of thickness	Turbo Grilling	360 - 380 ¹⁾	6 - 8	1
Roast beef or fillet: well done	per cm of thickness	Turbo Grilling	340 - 360 ¹⁾	8 - 10	1

1) Preheat the oven.

Pork

Food	Quantity (kg)	Function	Temperature (°F)	Time (min)	Shelf position
Shoulder / Neck / Ham joint	1 - 1.5	Turbo Grilling	320 - 360	90 - 120	1
Chop / Spare rib	1 - 1.5	Turbo Grilling	340 - 360	60 - 90	1
Meatloaf	0.75 - 1	Turbo Grilling	320 - 340	50 - 60	1
Pork knuckle (precooked)	0.75 - 1	Turbo Grilling	300 - 340	90 - 120	1

Veal

Food	Quantity (kg)	Function	Temperature (°F)	Time (min)	Shelf position
Roast veal	1	Turbo Grilling	320 - 360	90 - 120	1
Knuckle of veal	1.5 - 2	Turbo Grilling	320 - 360	120 - 150	1

Lamb

Food	Quantity (kg)	Function	Temperature (°F)	Time (min)	Shelf position
Leg of lamb / Roast lamb	1 - 1.5	Turbo Grilling	300 - 340	100 - 120	1

Food	Quantity (kg)	Function	Temperature (°F)	Time (min)	Shelf position
Saddle of lamb	1 - 1.5	Turbo Grilling	320 - 360	40 - 60	1

Game

Food	Quantity (kg)	Function	Temperature (°F)	Time (min)	Shelf position
Saddle / Leg of hare	up to 1	Top / Bottom Heat	450 ¹⁾	30 - 40	1
Saddle of venison	1.5 - 2	Top / Bottom Heat	410 - 430	35 - 40	1
Haunch of venison	1.5 - 2	Top / Bottom Heat	360 - 400	60 - 90	1

1) Preheat the oven.

Poultry

Food	Quantity (kg)	Function	Temperature (°F)	Time (min)	Shelf position
Poultry portions	0.2 - 0.25 each	Turbo Grilling	400 - 430	30 - 50	1
Half chicken	0.4 - 0.5 each	Turbo Grilling	380 - 410	35 - 50	1
Chicken, poulard	1 - 1.5	Turbo Grilling	380 - 410	50 - 70	1
Duck	1.5 - 2	Turbo Grilling	360 - 400	80 - 100	1
Goose	3.5 - 5	Turbo Grilling	320 - 360	120 - 180	1
Turkey	2.5 - 3.5	Turbo Grilling	320 - 360	120 - 150	1
Turkey	4 - 6	Turbo Grilling	280 - 320	150 - 240	1

Fish (steamed)

Food	Quantity (kg)	Function	Temperature (°F)	Time (min)	Shelf position
Whole fish	1 - 1.5	Top / Bottom Heat	410 - 430	40 - 60	1

8.9 Grilling

- Always grill with the maximum temperature setting.
- Set the shelf into the shelf position as recommended in the grilling table.
- Always set the pan to collect the fat into the first shelf position.

- Grill only flat pieces of meat or fish.
- Always preheat the empty oven with the grill functions for 5 minutes.



CAUTION!
Always grill with the oven door closed.

Grilling

Food	Temperature (°F)	Time (min)		Shelf position
		1st side	2nd side	
Roast beef	410 - 450	30 - 40	30 - 40	2
Filet of beef	450	20 - 30	20 - 30	3
Back of pork	410 - 450	30 - 40	30 - 40	2
Back of veal	410 - 450	30 - 40	30 - 40	2
Back of lamb	410 - 450	25 - 35	20 - 25	3
Whole Fish, 500 - 1000 g	410 - 450	15 - 30	15 - 30	3 / 4

Fast Grilling

Food	Time (min)		Shelf position
	1st side	1st side	
Burgers / Burgers	8 - 10	6 - 8	4
Pork fillet	10 - 12	6 - 10	4
Sausages	10 - 12	6 - 8	4
Fillet / Veal steaks	7 - 10	6 - 8	4
Toast / Toast	1 - 3	1 - 3	5
Toast with topping	6 - 8	-	4

8.10 Frozen foods

Use the function True Fan Cooking.

Food	Temperature (°F)	Time (min)	Shelf position
Pizza, frozen	400 - 430	15 - 25	2
Pizza American, frozen	380 - 410	20 - 25	2
Pizza, chilled	410 - 450	13 - 25	2
Pizza Snacks, fro- zen	360 - 400	15 - 30	2
French Fries, thin	400 - 430	20 - 30	3
French Fries, thick	400 - 430	25 - 35	3

Food	Temperature (°F)	Time (min)	Shelf position
Wedges / Croquettes	430 - 450	20 - 35	3
Hash Browns	410 - 450	20 - 30	3
Lasagne / Canneloni, fresh	340 - 380	35 - 45	2
Lasagne / Canneloni, frozen	320 - 360	40 - 60	2
Oven baked cheese	340 - 380	20 - 30	3
Chicken Wings	380 - 410	20 - 30	2

Frozen ready meals

Food	Function	Temperature (°F)	Time (min)	Shelf position
Frozen pizza	Top / Bottom Heat	as per manufacturer's instructions	as per manufacturer's instructions	3
French fries ¹⁾ (300 - 600 g)	Top / Bottom Heat or Turbo Grilling	400 - 430	as per manufacturer's instructions	3
Baguettes	Top / Bottom Heat	as per manufacturer's instructions	as per manufacturer's instructions	3
Fruit flans	Top / Bottom Heat	as per manufacturer's instructions	as per manufacturer's instructions	3

¹⁾ Turn the French fries 2 or 3 times during cooking.

8.11 Defrost

- Remove the food packaging and put the food on a plate.
- Use the first shelf position from the bottom.

- Do not cover the food with a bowl or a plate, as this can extend the defrost time.

Food	Quantity (kg)	Defrosting time (min)	Further defrosting time (min)	Comments
Chicken	1	100 - 140	20 - 30	Put the chicken on an upturned saucer in a big plate. Turn half-way through.
Meat	1	100 - 140	20 - 30	Turn half-way through.

Food	Quantity (kg)	Defrosting time (min)	Further defrosting time (min)	Comments
Meat	0.5	90 - 120	20 - 30	Turn halfway through.
Trout	0.15	25 - 35	10 - 15	-
Strawberries	0.3	30 - 40	10 - 20	-
Butter	0.25	30 - 40	10 - 15	-
Cream	2 x 0.2	80 - 100	10 - 15	Whip the cream when still slightly frozen in places.
Gateau	1.4	60	60	-

8.12 Preserving - Bottom Heat

- Use only preserve jars of the same dimensions available on the market.
- Do not use jars with twist-off and bayonet type lids or metal tins.
- Use the first shelf from the bottom for this function.
- Put no more than six one-litre preserve jars on the baking tray.
- Fill the jars equally and close with a clamp.
- The jars cannot touch each other.
- Put approximately 1/2 litre of water into the baking tray to give sufficient moisture in the oven.
- When the liquid in the jars starts to simmer (after approximately 35 - 60 minutes with one-litre jars), stop the oven or decrease the temperature to 220 °F (see the table).

Soft fruit

Food	Temperature (°F)	Cooking time until simmering (min)	Continue to cook at 220 °F (min)
Strawberries / Blueberries / Raspberries / Ripe gooseberries	320 - 340	35 - 45	-

Stone fruit

Food	Temperature (°F)	Cooking time until simmering (min)	Continue to cook at 220 °F (min)
Pears / Quinces / Plums	320 - 340	35 - 45	10 - 15

Vegetables

Food	Temperature (°F)	Cooking time until simmering (min)	Continue to cook at 220 °F (min)
Carrots ¹⁾	320 - 340	50 - 60	5 - 10
Cucumbers	320 - 340	50 - 60	-

Food	Temperature (°F)	Cooking time until simmering (min)	Continue to cook at 220 °F (min)
Mixed pickles	320 - 340	50 - 60	5 - 10
Kohlrabi / Peas / Asparagus	320 - 340	50 - 60	15 - 20

1) Leave standing in the oven after it is deactivated.

8.13 Drying - True Fan Cooking

the door and let it cool down for one night to complete the drying.

- Cover trays with grease proof paper or baking parchment.
- For a better result, stop the oven halfway through the drying time, open

Vegetables

Food	Temperature (°F)	Time (h)	Shelf position	
			1 position	2 positions
Beans	140 - 160	6 - 8	3	1 / 4
Peppers	140 - 160	5 - 6	3	1 / 4
Vegetables for soup	140 - 160	5 - 6	3	1 / 4
Mushrooms	120 - 140	6 - 8	3	1 / 4
Herbs	100 - 120	2 - 3	3	1 / 4

Fruit

Food	Temperature (°F)	Time (h)	Shelf position	
			1 position	2 positions
Plums	140 - 160	8 - 10	3	1 / 4
Apricots	140 - 160	8 - 10	3	1 / 4
Apple slices	140 - 160	6 - 8	3	1 / 4
Pears	140 - 160	6 - 9	3	1 / 4

9. CARE AND CLEANING



WARNING!
Refer to Safety chapters.

9.1 Notes on cleaning

- Clean the front of the appliance with a soft cloth with warm water and a cleaning agent.

- To clean metal surfaces, use a dedicated cleaning agent.
- Clean the appliance interior after each use. Fat accumulation or other food remains may result in a fire.
- Clean stubborn dirt with a special oven cleaner.

- Clean all accessories after each use and let them dry. Use a soft cloth with warm water and a cleaning agent.
- If you have nonstick accessories, do not clean them using aggressive agents, sharp-edged objects or a dishwasher. It can cause damage to the nonstick coating.

9.2 Removing the shelf supports

To clean the oven, remove the shelf supports.

1. Pull the front of the shelf support away from the side wall.

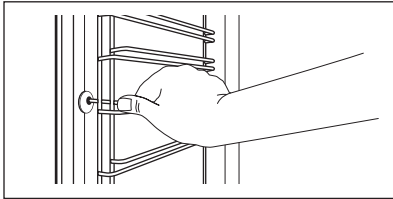

2. Pull the rear end of the shelf support away from the side wall and remove it.

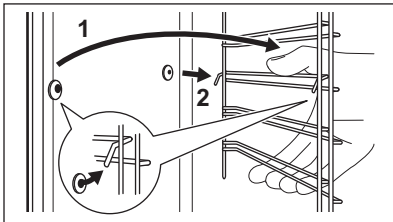

Install the shelf supports in the opposite sequence.

9.3 Catalytic cleaning



CAUTION!

Do not clean the catalytic surface with oven sprays, abrasive cleaning agents, soap or other cleaning agents. This will damage the catalytic surface.



Spots or discolouration of the catalytic surface have no effect on catalytic properties.



WARNING!

Keep children away when you clean the oven at a high temperature. The oven surface becomes very hot and there is a risk of burns.



Before activating the catalytic cleaning remove all the accessories from the oven.

The walls with a catalytic coating are self-cleaning. They absorb fat which collects on the walls while the appliance operates.

To support the self-cleaning procedure, heat the empty oven on a regular basis.

1. Clean the oven floor with warm water and washing up liquid, then dry it.
2. Set the function
3. Set the oven temperature to 480 °F and let the oven operate for 1 hour.
4. When the appliance is cool, clean it with a soft and moist sponge.

9.4 Removing and installing the door

You can remove the door and the internal glass panels to clean it. The number of glass panels is different for different models.



WARNING!

Be careful when you remove the door from the appliance. The door is heavy.

1. Open the door fully.
2. Fully press the clamping levers (A) on the two door hinges.

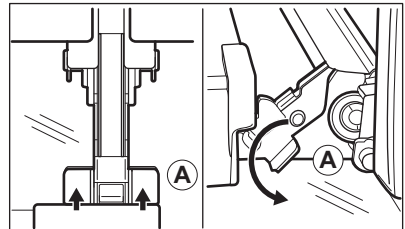

3. Close the oven door to the first opening position (approximately 70° angle).

4. Hold the door with one hand on each side and pull it away from the appliance at an upwards angle.
5. Put the door with the outer side down on a soft cloth on a stable surface. This is to prevent scratches.
6. Hold the door trim (B) on the top edge of the door at the two sides and push inwards to release the clip seal.

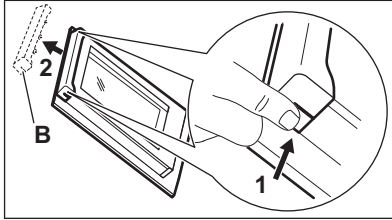

7. Pull the door trim to the front to remove it.
8. Hold the door glass panels on their top edge one by one and pull them up out of the guide.

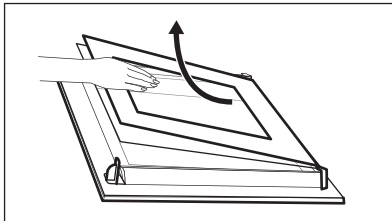

9. Clean the glass panel with water and soap. Dry the glass panel carefully. When the cleaning is completed, install the glass panels and the door. Do the

above steps in the opposite sequence. Install the smaller panel first, then the larger.

9.5 Replacing the lamp

Put a cloth on the bottom of the interior of the appliance. It prevents damage to the lamp glass cover and the cavity.



WARNING!

Danger of electrocution!

Disconnect the fuse before you replace the lamp.

The lamp and the lamp glass cover can be hot.

1. Deactivate the appliance.
2. Remove the fuses from the fuse box or deactivate the circuit breaker.

The top lamp

1. Turn the lamp glass cover counterclockwise to remove it.

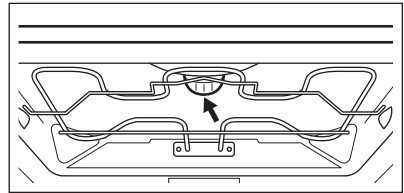

2. Clean the glass cover.
3. Replace the lamp with a suitable 570 °F heat-resistant lamp.
4. Install the glass cover.

10. TROUBLESHOOTING



WARNING!

Refer to Safety chapters.

10.1 What to do if...

Problem	Possible cause	Remedy
The oven does not heat up.	The oven is deactivated.	Activate the oven.

Problem	Possible cause	Remedy
The oven does not heat up.	The fuse is blown.	Make sure that the fuse is the cause of the malfunction. If the fuse is blown again and again, contact a qualified electrician.
The lamp does not operate.	The lamp is defective.	Replace the lamp.
Steam and condensation settle on the food and in the cavity of the oven.	You left the dish in the oven for too long.	Do not leave the dishes in the oven for longer than 15 - 20 minutes after the cooking process ends.

10.2 Service data

If you cannot find a solution to the problem yourself, contact your dealer or an Authorised Service Centre.

The necessary data for the service centre is on the rating plate. The rating

plate is on the front frame of the appliance cavity. Do not remove the rating plate from the appliance cavity.

We recommend that you write the data here:	
Model (MOD.)
Product number (PNC)
Serial number (S.N.)

11. ENERGY EFFICIENCY

11.1 Product Fiche and information according to EU 65-66/2014

Supplier's name	Electrolux
Model identification	EI24EW35LS
Energy Efficiency Index	103.5
Energy efficiency class	A
Energy consumption with a standard load, conventional mode	0.99 kWh/cycle
Energy consumption with a standard load, fan-forced mode	0.88 kWh/cycle
Number of cavities	1
Heat source	Electricity
Volume	71 l

Type of oven	Built-In Oven
Mass	33.5 kg

EN 60350-1 - Household electric cooking appliances - Part 1: Ranges, ovens, steam ovens and grills - Methods for measuring performance.

11.2 Energy saving



The appliance contains features which help you save energy during everyday cooking.

General hints

Make sure that the oven door is closed properly when the appliance operates and keep it closed as much as possible during the cooking.

Use metal dishes to improve energy saving.

When possible, do not preheat the oven before you put the food inside.

When the cooking duration is longer than 30 minutes, reduce the oven temperature to minimum 3 - 10 minutes before the end of the cooking time, depending on the duration of the cooking. The residual heat inside the oven will continue to cook.

Use the residual heat to warm up other dishes.

Cooking with fan

When possible, use the cooking functions with fan to save energy.

Keep food warm

Choose the lowest possible temperature setting to use residual heat and keep a meal warm.

12. WARRANTY

Your appliance is covered by a one year limited warranty. For one year from your original date of purchase, Electrolux will repair or replace any parts of this appliance that prove to be defective in materials or workmanship when such appliance is installed, used, and maintained in accordance with the provided instructions. In addition, the glass cooktop or radiant surface element of your appliance (excluding built-in and freestanding range appliances) is covered by a two through five year limited warranty. During the 2nd through 5th years from your original date of purchase, Electrolux will provide a replacement glass cooktop or radiant surface element for your appliance which has proven to be defective in materials or workmanship when such appliance is installed, used, and maintained in accordance with the provided instructions.

Exclusions

This warranty does not cover the following:

1. Products with original serial numbers that have been removed, altered or cannot be readily determined.
2. Product that has been transferred from its original owner to another party or removed outside the USA or Canada.
3. Rust on the interior or exterior of the unit.
4. Products purchased "as-is" are not covered by this warranty.
5. Products used in a commercial setting.
6. Service calls which do not involve malfunction or defects in materials or workmanship, or for appliances not in ordinary household use or used other than in accordance with the provided instructions.
7. Service calls to correct the installation of your appliance or to instruct you how to use your appliance.
8. Expenses for making the appliance accessible for servicing, such as removal of trim, cupboards, shelves, etc., which are not a part of the

- appliance when it is shipped from the factory.
9. Service calls to repair or replace appliance light bulbs, air filters, water filters, other consumables, or knobs, handles, or other cosmetic parts.
 10. Labor or in-home service costs during the additional limited warranty periods beyond the first year from your original date of purchase.
 11. Pickup and delivery costs; your appliance is designed to be repaired in the home.
 12. Surcharges including, but not limited to, any after hour, weekend, or holiday service calls, tolls, ferry trip charges, or mileage expense for service calls to remote areas, including the state of Alaska.
 13. Damages to the finish of appliance or home incurred during transportation or installation, including but not limited to floors, cabinets, walls, etc.
 14. Damages caused by: services performed by unauthorized service companies; use of parts other than genuine Electrolux parts or parts obtained from persons other than authorized service companies; or external causes such as abuse, misuse, inadequate power supply, accidents, fires, or acts of God.

Disclaimer of implied warranties; Limitation of remedies

Customer's sole and exclusive remedy under this limited warranty shall be repair or replacement as provided herein.

Claims based on implied warranties, including warranties of merchantability or fitness for a particular purpose, are limited to one year or the shortest period allowed by

law, but not less than one year.

Electrolux shall not be liable for consequential or incidental damages such as property damage and incidental expenses resulting from any breach of this written limited warranty or any implied warranty. Some states and provinces do not allow the exclusion or limitation of incidental or consequential damages, or limitations on the duration of implied warranties, so these limitations or exclusions may not apply to you. This written warranty gives you specific legal rights. You may also have other rights that vary from state to state.

If You Need Service

Keep your receipt, delivery slip, or some other appropriate payment record to establish the warranty period should service be required. If service is performed, it is in your best interest to obtain and keep all receipts. Service under this warranty must be obtained by contacting Electrolux at the addresses or phone numbers below. This warranty only applies in the USA, Puerto Rico and Canada. In the USA and Puerto Rico, your appliance is warranted by Electrolux Major Appliances North America, a division of Electrolux Home Products, Inc. In Canada, your appliance is warranted by Electrolux Canada Corp. Electrolux authorizes no person to change or add to any obligations under this warranty. Obligations for service and parts under this warranty must be performed by Electrolux or an authorized service company. Product features or specifications as described or illustrated are subject to change without notice.

USA
1-877-435-3287
 Electrolux Major Appliances
 North America
 10200 David Taylor Drive
 Charlotte, NC 28262

Canada
1-800-265-8352
 Electrolux Canada Corp.
 5855 Terry Fox Way
 Mississauga, Ontario, Canada L5V 3E4

13. ENVIRONMENTAL CONCERNS

Recycle materials with the symbol . Put the packaging in relevant containers to recycle it. Help protect the environment and human health by recycling waste of electrical and electronic appliances. Do not dispose of

appliances marked with the symbol  with the household waste. Return the product to your local recycling facility or contact your municipal office.

www.electrolux.com/shop



867316713-D-312018

