

# ELICA PRO SERIES LEONE ISLAND



ELICA'S EXCLUSIVE  
PLUS FEATURES



Designed to be suspended above a kitchen island, Leone's crisp lines, beveled rim and gleaming stainless steel deliver professional cooking with a sense of style. Give your kitchen a splash of Italian design with a chimney style island hood that has the extra depth and power required to support professional ranges and cooktops.

Available in 36" and 42" widths, Leone Island comes equipped with an extra powerful 1200 CFM internal blower and backlit hidden metallic in/out knobs, which operate the 4 speed blower and LED lighting.

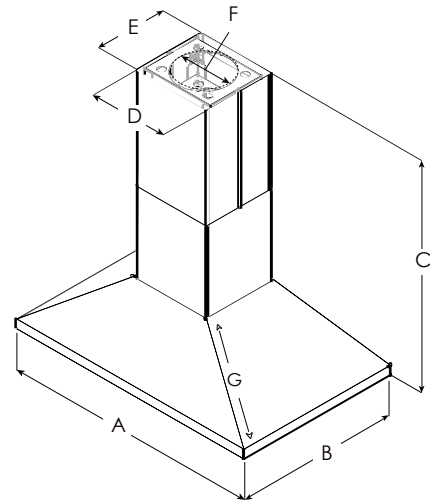

	ELI136S1 ELI136S2	ELI142S1 ELI142S2
A	36" (91.4 cm)	42" (106.7 cm)
B	27" (68.6 cm)	
C	Max: 46 1/8" (118.3 cm) Min: 37 1/2" (95.3 cm)	
D	13 1/4" (33.2 cm)	
E	12" (30.5 cm)	
F	8" (20.3 cm)	
G	12 3/16" (32.3 cm)	

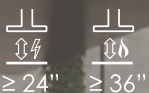
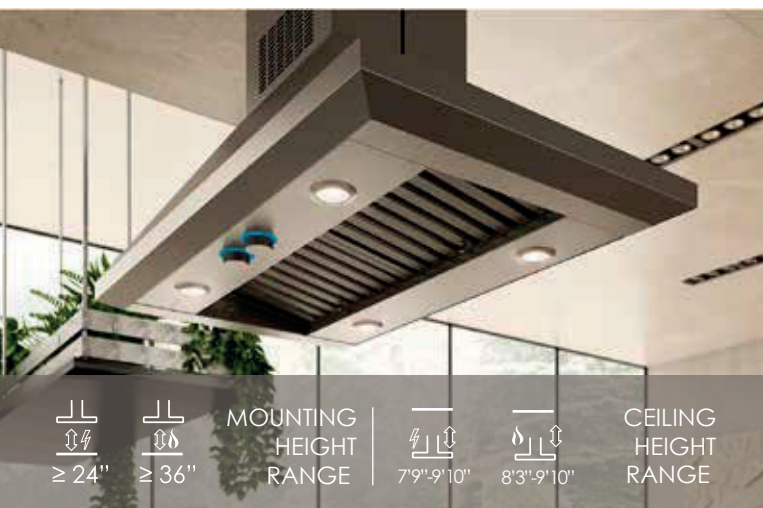

MOUNTING  
HEIGHT  
RANGE



CEILING  
HEIGHT  
RANGE







# ELICA PRO SERIES LEONE ISLAND



## SPECIFICATIONS

	36" Unit	42" Unit
<b>Model:</b> <b>Dimensions:</b> <b>Blower Type (internal):</b> <b>Blower Performance:</b> Speed 1 Speed 2 Speed 3 Speed 4 <b>Noise (sones):</b> Working Speed <b>Finish:</b> <b>Controls:</b> <b>Illumination:</b> (replaceable lamps 1 intensity) <b>Filter Type:</b> <b>Angled Baffle Filters:</b> <b>Duct Transition:</b> <b>Installation Type:</b> <b>Electrical:</b>	ELI136S1 ELI136S2 36"W x 27"D x 12 3/4"H 1200 CFM (4-speed)  375 CFM 640 CFM 940 CFM 1200 CFM  Min:3.21, Max:7.7  Stainless Steel Fully retractable rotating knobs with blue backlighting  4 LED, 7.5 Watts LED light  Dishwasher-Safe, Professional Stainless Steel 2 8" Round with BackDraft Damper (top only) Ducted Installation Only 120V - 60 Hz	ELI142S1 ELI142S2 42"W x 27"D x 12 3/4 "H 1200 CFM (4-speed)  375 CFM 640 CFM 940 CFM 1200 CFM  Min:3.21, Max:7.7  Stainless Steel Fully retractable rotating knobs with blue backlighting  4 LED, 7.5 Watts LED light  Dishwasher-Safe, Professional Stainless Steel 2 8" Round with BackDraft Damper (top only) Ducted Installation Only 120V - 60 Hz
<b>KITS:</b> Long Chimney Extension Kit:	KIT0100317	KIT0100317
<b>CONSUMABLE PARTS:</b> Replacement Grease Filter (1): Replacement Light Bulb (1):	GF09EA  LMP0131098	GF09EA  LMP0131098
*Consumable parts are sold in units of one (1). Order accordingly		
<b>INSTALL HEIGHTS:</b> Ranger Hood:  Ranger Hood with extension duct covers:	Min: 8'3", Max: 9'10"  Min:10'1", Max:13'6"	

## PLUS FEATURES

- 
**HUSH SYSTEM** - An exclusive sound deadening technology that effectively reduces sound levels by over 35%
- 
**LED CONSUMER REPLACEABLE BULB** - High quality LED lighting usually requires a skilled technician to replace lamps. Avoid this expense with Elica's new LED lamps that enable homeowners to replace in seconds
- 
**SEAMLESS CRAFTSMANSHIP** - Heavy gauge stainless steel "Seamless" construction that delivers refined elegance.
- 
**STAINLESS STEEL BAFFLE FILTERS WITH GREASE COLLECTORS** - Designed for high airflow cooking, the "S" shape design traps high volumes of grease
- 
**PROFESSIONAL PERFORMANCE** - Special features and high performances for models with aspiration capacity between 600 and 1200 CFM's
- 
**HEAT GUARD** - Senses extreme temperatures (>158 degrees) and automatically adjusts the blower speed to HIGH