

ELICA PRO SERIES VAVANO



HUSH SYSTEM



LED REPLACEABLE



SEAMLESS LOOK



GREASE COLLECTORS



PROFESSIONAL PERFORMANCE



HEAT GUARD

ELICA'S EXCLUSIVE PLUS FEATURES

Give a splash of Italian design to your professional kitchen with Vavano's crisp lines, seamless welded corner craftsmanship, beveled rim and gleaming stainless steel. No ear plugs required with Vavano's HUSH sound suppression system, which enables you to comfortably talk and entertain, even when cooking up a storm. Available in 36" and 48" widths, Vavano features backlit hidden knob controls, which operate the 4-speed blower and LED lighting. Easy maintenance and cleaner kitchen are assured with professional stainless steel angled baffle filters.

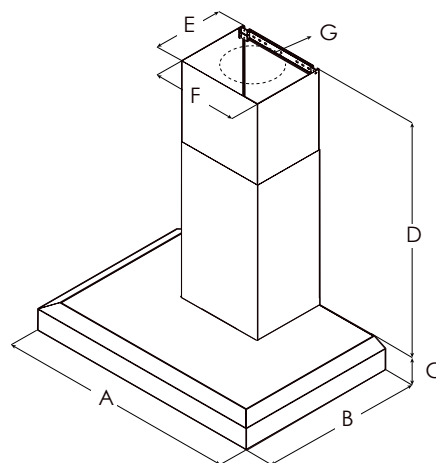

	EVV636SS EVV636S1	EVV648SS EVV636S1
A	36" (91.4 cm)	48" (122 cm)
B	24" (61 cm)	
C	5" (12.8 cm)	
D	Max: 54" (137 cm) Min: 30" (76.3 cm)	
E	10 ⁵ / ₈ " (26.9 cm)	
F	13 ⁵ / ₄ " (33.2 cm)	
G	8" (20.3 cm)	

ELICA PRO SERIES VAVANO





SPECIFICATIONS

	36" Unit	48" Unit
Model:	EVV636SS EVV636S1	EVV648SS EVV648S1
Dimensions:	36"W x 24"D x 5"H	48"W x 24"D x 5" H
Blower Type(internal):	600 CFM (4 -speed)	
Blower Performance:		
Speed 1	202 CFM	
Speed 2	350 CFM	
Speed 3	510 CFM	
Speed 4	600 CFM	
Noise (sones):	Min: 3.21, Max: 7.7	
Working Speed		
Finish:	Stainless Steel	
Controls:	Fully retractable rotating knobs with blue backlighting	
Illumination:	2 LED, 7.5 W (replaceable lamps 1 intensity)	
Filter Type:	2 Dishwasher-Safe, Professional Stainless Steel	
Angled Baffle Filters:	2	3
Duct Transition:	8" Round with Back Draft Damper (top only)	
Installation Type:	Ducted Installation Only	
Electrical:	120V - 60 Hz	
KITS:		
Long Chimney Extension Kit 12":	KIT0146881	
Inline Blower Kit (1200 CFM):	KIT0154387	
External Blower Kit:	KIT0153054	
CONSUMABLE PARTS:		
Grease Filter (1):	GF09GA	GF09EA
Light Bulb (1):	LMP0131098	
*Consumable parts are sold in units of one (1). Order accordingly		
INSTALL HEIGHTS:		
Ranger Hood:	Ducted - Min: 8'0", Max: 10'6"	
Ranger Hood with extension duct covers:	Ducted - Min: 9'6", Max: 13'6"	

PLUS FEATURES

- 

HUSH SYSTEM - An exclusive sound deadening technology that effectively reduces sound levels by over 35%
- 

STAINLESS STEEL BAFFLE FILTERS WITH GREASE COLLECTORS - Designed for high airflow cooking, the "S" shape design traps high volumes of grease
- 

LED CONSUMER REPLACEABLE BULB - High quality LED lighting usually requires a skilled technician to replace lamps. Avoid this expense with Elica's new LED lamps that enable homeowners to replace in seconds
- 

PROFESSIONAL PERFORMANCE - Special features and high performances for models with aspiration capacity between 600 and 1200 CFM's
- 

SEAMLESS CRAFTSMANSHIP - Heavy gauge stainless steel "Seamless" construction that delivers refined elegance.
- 

HEAT GUARD - Senses extreme temperatures (>158 degrees) and automatically adjusts the blower speed to HIGH