



AIR IS PRECIOUS.
THIS EVERYDAY AWARENESS, HAS ALWAYS DRIVEN
ELICA'S DESIGN SENSE, SUPPORTED BY THE MOST
ADVANCED TECHNOLOGY IN THE FIELD.
ALL ELICA SERIES ARE ABLE TO MEET THE NEEDS
RELATED TO THE DIFFERENT WAYS OF LIVING
AND COOKING ALL AROUND THE WORLD.

AIR COOKING / 20

A REVOLUTIONARY COOKING SYSTEM WITH SMART INDUCTION COOKTOP AND “TWO IN ONE” INDUCTION COOKTOP WITH BUILT-IN VENTILATION.

TECHNE PLUS / 36

RANGE HOODS EQUIPPED WITH SMART WIRELESS SENSOR TECHNOLOGY AND AUTOMATIC FUNCTIONS.

TECHNE / 46

THE TECHNE SERIES BRING EVERYDAY ITALIAN LIVING INTO YOUR KITCHEN.

ELICA PRO / 78

FOR THOSE INSPIRED BY THE CULINARY ARTS AND GOURMET COOKING.

ICONIC / 100

A FOCUS ON DESIGN THAT MAKES A STATEMENT IN ANY HOME.

COMFORT / 112

COMFORT SERIES FEATURED HIGHLY POPULAR ITALIAN HOODS DESIGN WITH A CORE SET OF FEATURES THAT DELIVER VALUE TO THE CONSUMER.



INDEX

INDUCTION COOKTOPS



NIKOLA TESLA
AIR COOKING
22



GOLDEN 30
AIR COOKING
29



GOLDEN 24
AIR COOKING
28



GOLDEN 36
AIR COOKING
30

ISLAND



METEORITE
ISLAND
TECHNE PLUS
40



MAGGIORE
TECHNE
74



STAR
ICONIC
104



STONEY
ISLAND
TECHNE PLUS
44



SALICE
TECHNE
76



WAVE
ICONIC
106



CINGOLI
TECHNE
50



LEONE ISLAND
ELICA PRO
82



TWIN
ICONIC
107



VAVANO
ISLAND
ELICA PRO
86



SIENA
ICONIC
108



EASY
ICONIC
102



CHROME
ICONIC
110

WALL-MOUNT



METEORITE
TECHNE PLUS
38



PILATO
TECHNE
66



STONEY
TECHNE PLUS
42



LUGANO
TECHNE
72



COMO
TECHNE
48



LEONE
ELICA PRO
80



VOLTERRA
COMFORT
117



MEZZANO
TECHNE
52



VAVANO
ELICA PRO
84



TOBLINO
COMFORT
118



VARNA BLACK
TECHNE
54



CALABRIA
ELICA PRO
88



POTENZA
COMFORT
119



VARNA
TECHNE
56



CAPRI
ELICA PRO
96



FOGLIA
TECHNE
58

INDEX

UNDER-CABINET



ARIA
TECHNE
60



CERVINIA
ELICA PRO
88



ALLASIO
COMFORT
115



MODENA
TECHNE
62



GLIDE
ICONIC
111



NEMI
COMFORT
116



BELLAGIO
TECHNE
64



TT
COMFORT
114



SORA
COMFORT
121

DOWNDRAFT

RISE
TECHNE
70



INSERT



PALERMO
TECHNE
68



TRENTO
ELICA PRO
94



AREZZO
ELICA PRO
92



ASTI
COMFORT
120

CEILING-MOUNT



SIENA
ICONIC
108

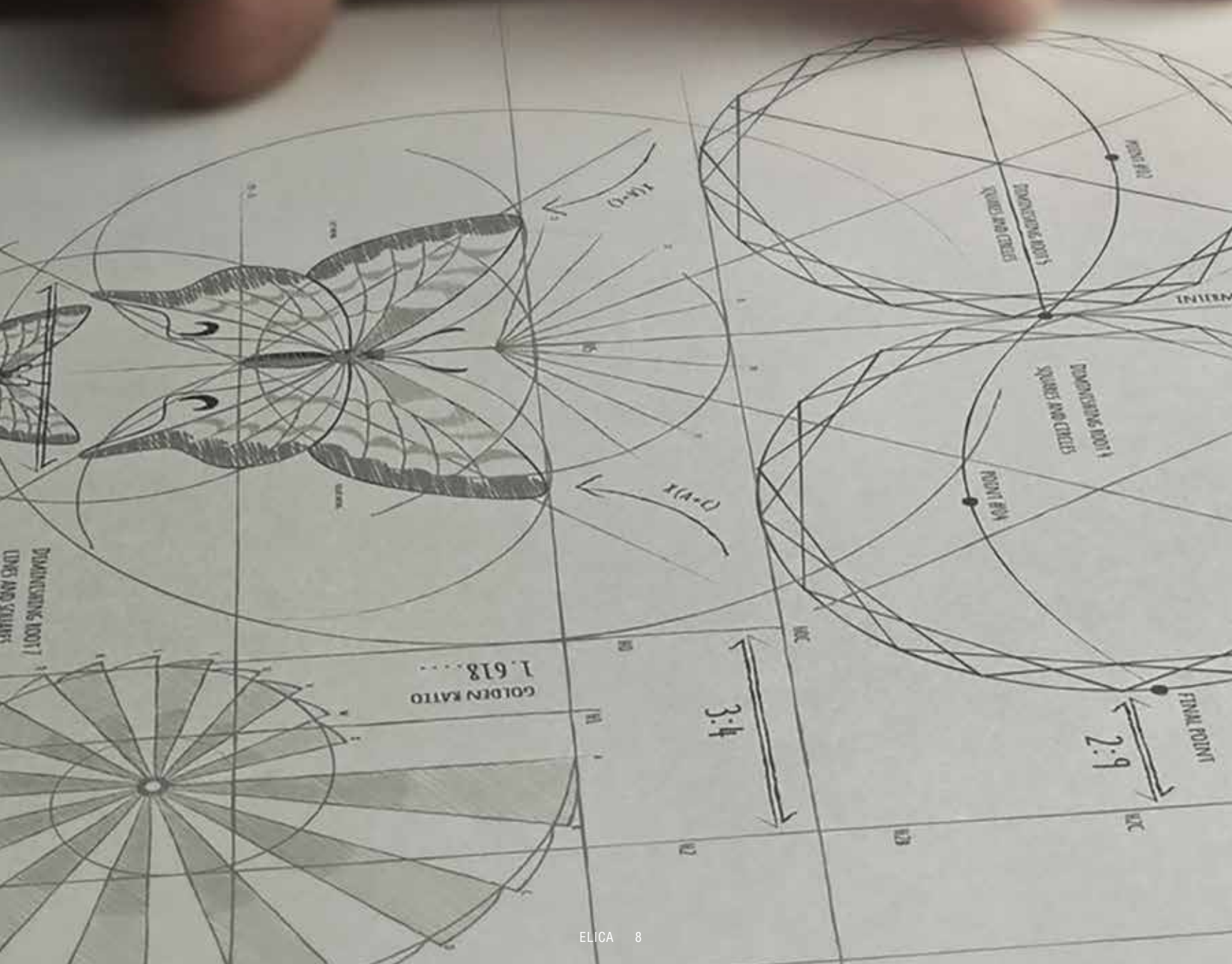

Design is the object's soul, not just their "appearance".

Elica's focus on innovation and design is well represented by these appliances, which are aesthetically appealing, high performing, user-friendly and easy to install. The products have been developed around the individual, their needs and living spaces. Elica has always believed that the combination of superior quality and cutting edge design is the secret to products that stand the test of time.

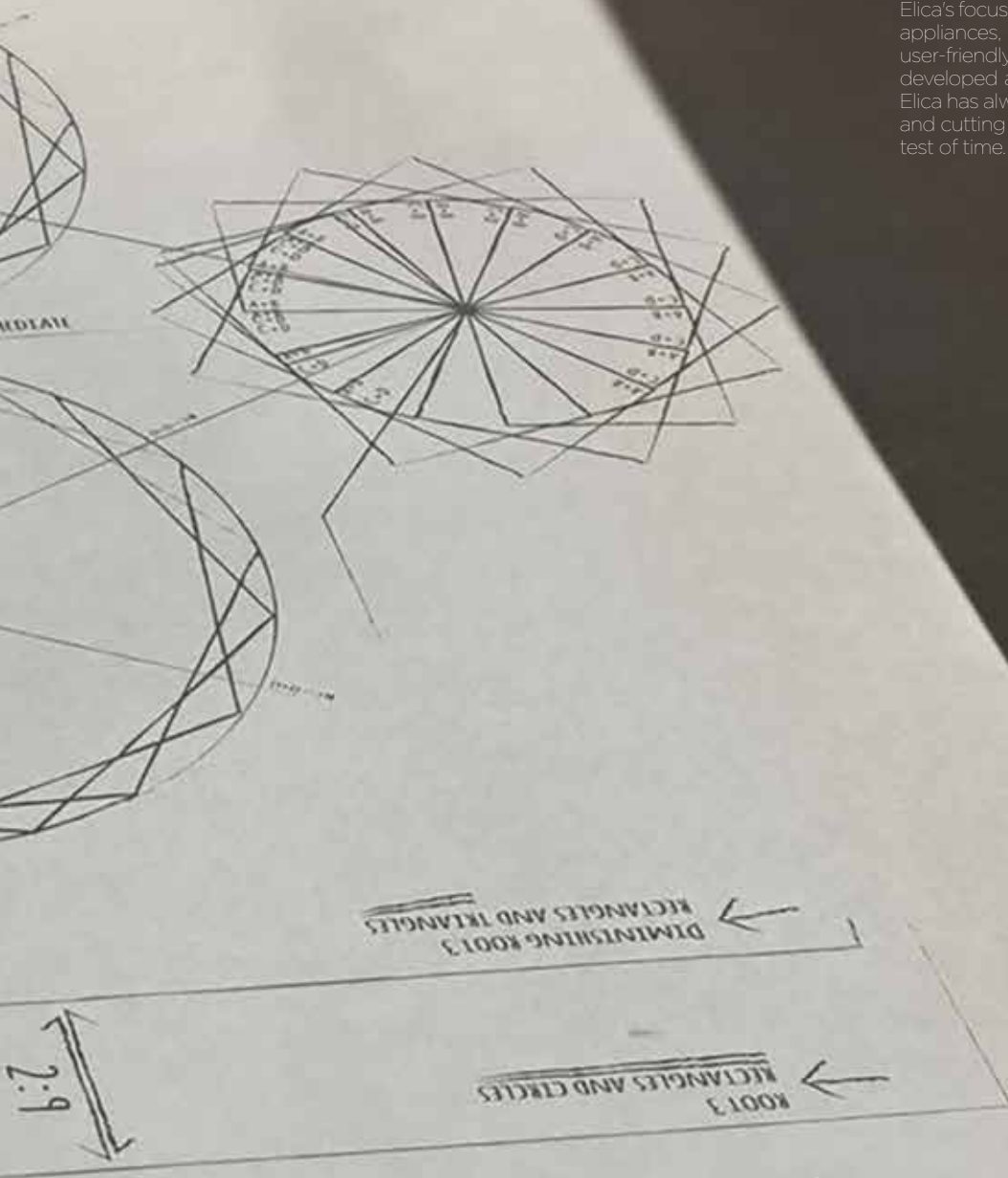

Global Leader

Elica, an Italian company that was founded in 1970, has grown beyond its national borders and is now manufacturing and marketing around the world. The company is recognized as the global leader in kitchen ventilation and a symbol of Made in Italy. Elica is synonymous with high-tech products that deliver real convenience and value to the consumer. We are also appreciated for our ethical values that drive corporate responsibility to the environment, consumers and its employees.

**SHARED VALUES: LOVE OUR CLIENTS,
INNOVATIVE THINKING, INVOLVE
EVERYONE WHO WORKS IN ELICA,
HAVE AND CONVEY ENERGY, ALWAYS
SET GOALS, BE CURIOUS, NEVER STOP
LEARNING, STRIVE TO WIN.**





THE EXPERIENCE
AND DEDICATION
OF OUR LABORATORY
TECHNICIANS WITH CONSTANT
FEEDBACK FROM THE FIELD,
FOCUSED ON COMMON GOALS
AND DRIVEN BY CONSUMER
SATISFACTION AND PERFECTION:
A COMBINATION OF KEY FACTORS
THAT DELIVERS UNEQUALED
QUALITY, RELIABILITY AND
PERFORMANCE AROUND
THE GLOBE.

FOCUS

EPL
Elica Propulsion Laboratory

ELICA PROPULSION LABORATORY
At the heart of innovation



EVERYDAY EXCELLENCE.

ELICA HAS DEVELOPED AN INNOVATION METHOD THAT BLENDS DIFFERENT APPROACHES: LISTEN TO THE CLIENT, MEET THEIR REQUIREMENTS AND FORESEE THEIR NEEDS, THUS CREATING NEW MARKET TRENDS. THE IMPLEMENTATION OF THESE DIFFERENT APPROACHES IS ONLY POSSIBLE THANKS TO TECHNOLOGY, THAT HAS LED TO EXTRAORDINARY INNOVATION AND EVERYDAY INSPIRATION.

ELICA CONNECTIVITY SYSTEM

breathe. feel. control.



FULLY AUTOMATIC HOOD

ELICA CONNECTIVITY SYSTEM

A NEW GENERATION OF SMART SYSTEMS,
CONNECTING HOODS AND COOKTOPS,
WAS BORN.

1/

/ THE
COOKTOP
INFORMS

2/

/ THE HOOD
RECEIVES

3/

/ THE HOOD
PROCESSES

4/

/ THE HOOD
ADJUSTS ITS AIR
CAPACITY



THIS NEW LINE OF RANGE HOODS CAN DETECT NOT ONLY THE QUANTITY BUT ALSO THE QUALITY OF VAPOURS EMITTED DURING COOKING.

ELICA CONNECTIVITY SYSTEM

THE COOKTOP INFORMS THE HOOD ABOUT THE NUMBER AND POWER OF ZONES ON AND THE PRESENCE OF POTS.



THANKS TO ITS INNOVATIVE SENSORS, THE HOOD RECOGNIZES THE QUANTITY OF COOKING VAPORS AND REACTS IN REAL TIME BY INTEGRATING THE INFORMATION FROM THE COOKTOP, THUS ACTIVATING THE MOST SUITABLE PERFORMANCE LEVEL.



THANKS TO **ELICA CONNECTIVITY SYSTEM**, PERFORMANCE IS OPTIMISED AND EXCELLENT AIR QUALITY IS ASSURED.

THE HOOD ALSO ANALYSES THE COMPOSITION OF VAPOURS EMITTED, THUS ENABLING TO ADJUST ITS OPERATION LEVEL AND ASSURE EXCELLENT AIR QUALITY.



THE HOOD WILL CONTINUE RUNNING UNTIL THE AIR QUALITY MEANS IT IS NO LONGER NEEDED AND THEN TURNS ITSELF OFF PREVENTING THE WASTE OF ENERGY.



AIR COOKING

A NEW RANGE OF INDUCTION PRODUCTS FOR THE COOKING SYSTEM IN ELICA. ASPIRATION COOKTOPS AND INDUCTION COOKTOPS. NIKOLATESLA IS THE FIRST ELICA'S ASPIRATION COOKTOP PRODUCT, WHICH COMBINES THE FUNCTIONALITY OF TWO HOME APPLIANCES IN ONE: COOKTOP AND HOOD. THIS PRODUCT LINE FEATURES ALSO INDUCTION COOKTOPS EQUIPPED WITH CONNECTIVITY TECHNOLOGY, WHICH IS A WIRELESS SENSOR SYSTEM THAT CONNECTS THE COOKTOP WITH ELICA CONNECTED HOODS (TECHNE PLUS SERIES).





153221880048E12230MED4

All pictures shown are for illustration purpose only. Actual product may vary due to product enhancement.



AN UNCONVENTIONAL UNION FOR
ANYONE WHO LOVES THINKING
OUTSIDE THE BOX.



NIKOLATESLA

DESIGN FABRIZIO CRISÀ

The first aspirating cooktop by Elica. The aspiration system, equipped with a central fan, can reach very high performance levels in terms of fume capture, low noise level and energy efficiency. Thanks to a direct communication with the cooktop, NikolaTesla receives the information coming from the cooking burn zones and automatically sets ideal aspiration speed value. Available in recirculating mode. The cooktop has been designed to fit in any type of living space.

COOKTOP & RANGE HOOD



FOCUS ON NIKOLATESLA

By opening the cover, the user can easily remove the four (4) high performance ceramic carbon filters for effortless cleaning in the oven.



Ceramic filters can be extracted directly from above. They have a term of five years and can be regenerated in the oven.



By removing the grid, you can easily remove the 6 layer anodized aluminum mesh grease filter for easy cleaning in the dishwasher. Any spilled liquids during cooking will be captures in the cavity below the grease filter and can be easily removed by opening the drain valve and wiping out any residual with a cloth. The blower is completely sealed off and protected from any liquid spills.



The drain valve guarantees cleanliness also in the case of abundant overflow of liquids.

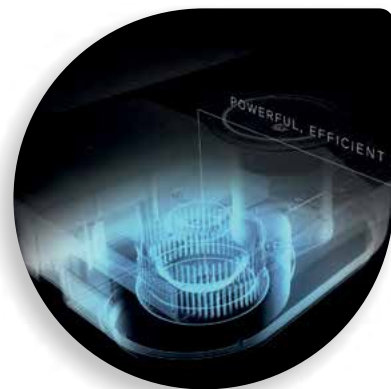

Cooking vapors and odors rise to the top at a speed of about 1 m/s and are then captured by NikolaTesla, which has a fume capture speed of 5,1 m/s. In this way, the depression that is created is able to effectively catch all the vapors and odors that are generated.

Elica Patent 102016000034820





NikolaTesla installation with Trim Kit, reaches 36".

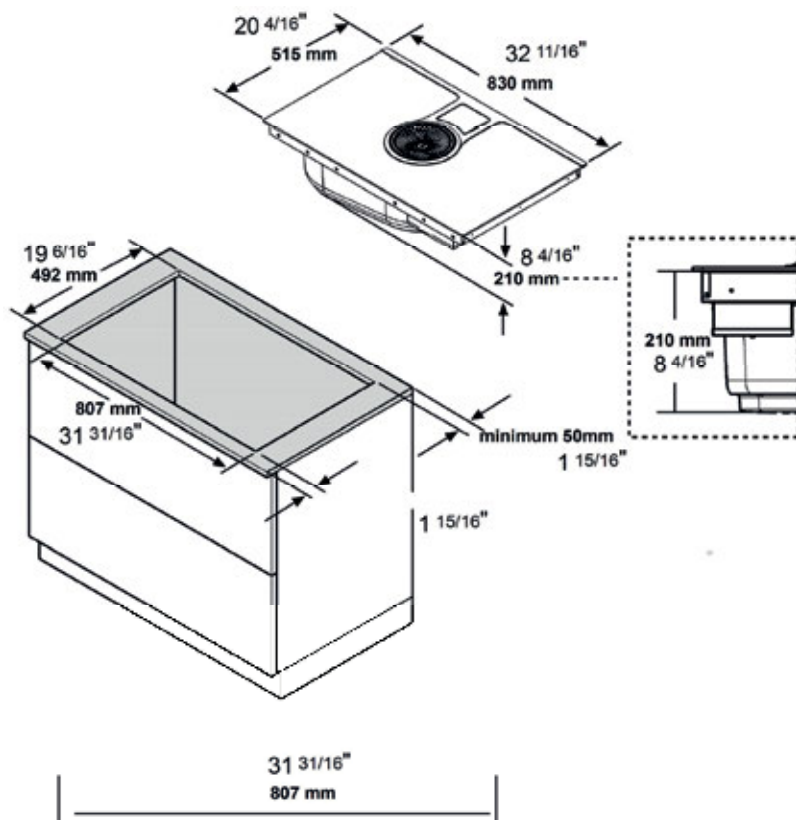

DIMENSIONS AND CLEARANCES

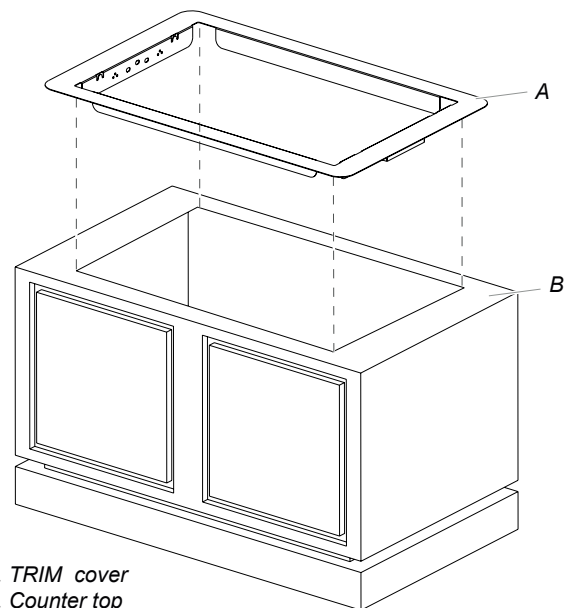

A. TRIM cover
B. Counter top

NikolaTesla has been designed to fit into many different types of kitchens. For the North America version, all ducting and vent cover materials to be supplied by the installer.



Reference image only.



NIKOLATESLA

DESIGN FABRIZIO CRISA



reddot design award
winner 2017



TOUCH
CONTROL



EASY
INSTALLATION



REVOLUTION
FILTER



BRIDGE ZONES



POT
DETECTOR



STOP&GO



TEMPERATURE
MANAGER

Size	32 1/16"W x 20 1/16"D x 8 1/4"H
Type Finish	Black Glass
Installation Type	Ducted or Recirculating Self Rimming or Flush Mounted

COOKTOP

Absorption	440 W
Frequency	60 Hz
Voltage	208 - 240 V
Cooking Zones	4 (2,1 - 3,7 kW) - 7,1 x 7,9 inches
Bridge Zones	2
Heating Level	9 Levels + Booster

FUNCTIONS

TOUCH CONTROL	✓
9 POWER LEVEL	✓
POWER BOOSTER	✓
RESIDUAL HEAT INDICATOR	✓
AUTOMATIC HEAT UP	✓
TIMER	✓
EGG TIMER	✓
SAFE ACTIVATION & CHILD LOCK	✓
SAFETY SHUT DOWN	✓
COLD SURFACE	✓

ASPIRATION SYSTEM

Controls	Slider Touch Control 3S + Booster Ventilation
Blower Type	400 CFM (4-speed)
Noise (sones)	Min: 2,2, Max: 5,0
Blower Performance	Speed 1, 160 CFM Speed 2, 250 CFM Speed 3, 350 CFM Speed 4, 400 CFM
Duct transition	3 1/4" x 10" Round

6 Layer Anodized Aluminum Mesh Grease Filter

ACCESSORIES

Stainless Steel Trim Kit 36" CODE: KIT0155746

MODELS

NIKOLATESLA 33" ENT432BL



Reference image only.

GOLDEN 24

ELICA DESIGN CENTER



TOUCH CONTROL



WIRELESS CONNECTIVITY



TEMPERATURE MANAGER



STOP&GO



POT DETECTOR



BRIDGE ZONES

Size	24"
Dimensions	23 3/4"W x 20 3/4"D x 2 1/4"H
Type Finish	Black Glass
Controls	Electronic Glass Touch with Finger Glide Function
Installation Type	Self Rimming or Flush Mounted
Total absorption	7,7 kW
Frequency	60 Hz
Voltage	208 - 240 V
Cooking Zones	3 Cooking Zones + 1 Bridge Zone (24") 1 (2,3 - 3,7kW) - Ø 10,2"
Heating Level	9 Levels + Booster
Electrical	208 - 240 V - 60 Hz 7.7 kW at 32.1 Amps 6.7 kW at 32.2 Amps

FUNCTIONS

TOUCH CONTROL
POWER BOOSTER
RESIDUAL HEAT INDICATOR
SAFE ACTIVATION & CHILD LOCK
TIMER
COLD SURFACE
9 POWER LEVEL
AUTOMATIC HEAT UP
SAFETY SHUTDOWN

MODELS

GOLDEN 24"

EGL324BL

Possible ways of installation on page 31



Reference image only.

GOLDEN 30

ELICA DESIGN CENTER



Size	30"
Dimensions	29 3/4"W x 20 3/4"D x 2 1/4"H
Type Finish	Black Glass
Controls	Electronic Glass Touch with Finger Glide Function
Installation Type	Self Rimming or Flush Mounted
Total absorption	7,7 kW
Frequency	60 Hz
Voltage	208 - 240 V
Cooking Zones	4 Cooking Zones + 1 Bridge Zone (30")
	2 (2,1 - 3,7kW) - 7,2 x 8,6"
	1 (2,3 - 3,7kW) - Ø 10,2"
	1 (1,4 - 2,2kW) - Ø 5,7"
Heating Level	9 Levels + Booster
Electrical	208 - 240 V - 60 Hz
	7.7 kW at 32.1 Amps
	6.7 kW at 32.2 Amps

- FUNCTIONS
- TOUCH CONTROL
- POWER BOOSTER
- RESIDUAL HEAT INDICATOR
- SAFE ACTIVATION & CHILD LOCK
- TIMER
- COLD SURFACE
- 9 POWER LEVEL
- AUTOMATIC HEAT UP
- SAFETY SHUTDOWN

MODELS	
GOLDEN 30"	EGL430BL

Possible ways of installation on page 31



Reference image only.

GOLDEN 36

ELICA DESIGN CENTER



Size	36" 35 3/4"W x 20 3/4"D x 2 1/4"H
Type Finish	Black Glass
Controls	Electronic Glass Touch with Finger Glide Function
Installation Type	Self Rimming or Flush Mounted
Total absorption	11.5 kW
Frequency	60 Hz
Voltage	208 - 240 V
Cooking zones	5 Cooking Zones + 2 Bridge Zones (36") 1 (2,3 - 3,7kW) - Ø 10,2"
Heating Level	9 Levels + Booster
Electrical	208 - 240 V - 60 Hz 11.5 kW at 47.9 Amps 10 kW at 48.1 Amps

- FUNCTIONS**
- TOUCH CONTROL
 - POWER BOOSTER
 - RESIDUAL HEAT INDICATOR
 - SAFE ACTIVATION & CHILD LOCK
 - TIMER
 - COLD SURFACE
 - 9 POWER LEVEL
 - AUTOMATIC HEAT UP
 - SAFETY SHUTDOWN

MODELS	GOLDEN 36" EGL536BL
---------------	--

Possible ways of installation on page 31



SELF RIMMING INSTALL

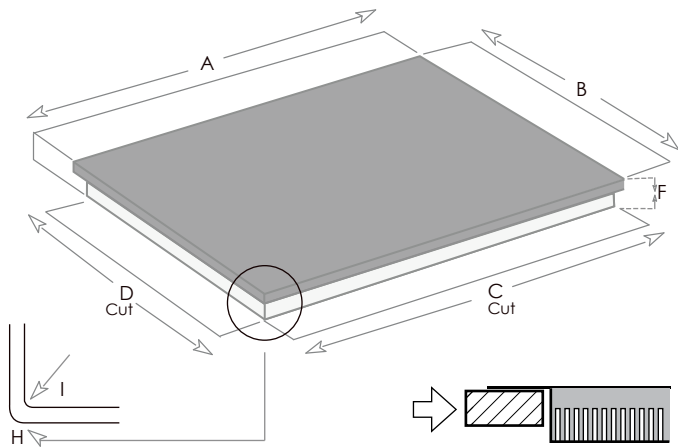

FLUSH MOUNTED INSTALL

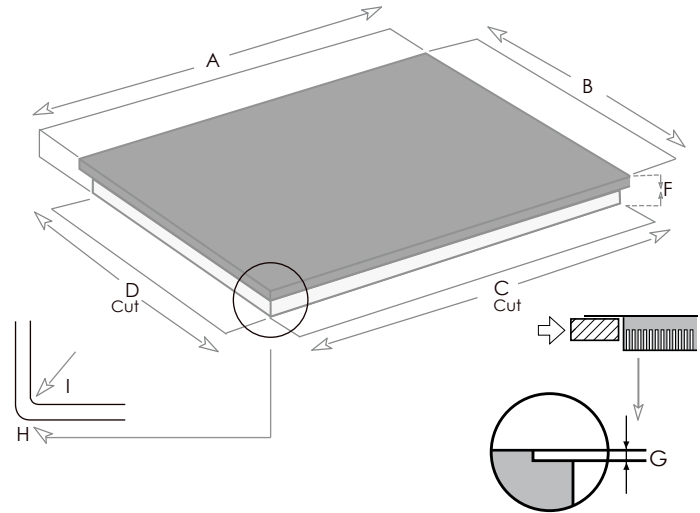

	EGL324BL	EGL430BL	EGL536BL
A	23 3/4"	29 3/4"	35 3/4"
B	20 3/4"	20 3/4"	20 3/4"
C	Min: 21 15/16" Max: 22 1/8"	Min: 28 9/32" Max: 28 1/2"	Min: 33 11/16" Max: 33 15/16"
D	Min: 19 7/32" Max: 19 19/32"	Min: 19 7/32" Max: 19 19/32"	Min: 19 7/32" Max: 19 19/32"
F	2 15/16"	2 15/16"	2 15/16"
G	1/4"	1/4"	1/4"
H	1 1/8"	1 1/8"	1 1/8"

	EGL324BL	EGL430BL	EGL536BL
A	23 3/4"	29 3/4"	35 3/4"
B	20 3/4"	20 3/4"	20 3/4"
C	Min: 21 15/16" Max: 22 1/8"	Min: 28 9/32" Max: 28 1/2"	Min: 33 11/16" Max: 33 15/16"
D	Min: 19 7/32" Max: 19 19/32"	Min: 19 7/32" Max: 19 19/32"	Min: 19 7/32" Max: 19 19/32"
F	2 15/16"	2 15/16"	2 15/16"
G	1/4"	1/4"	1/4"
H	1 1/8"	1 1/8"	1 1/8"
I	1/4"	1/4"	1/4"

Self Rimming Without frame, with glass laid on the working plan/top

Flush Mount Inserted in a 1/32 inch slot, without neither any perimetral border nor discontinuity with the working plan/top



COOKTOP PLUSES



WIRELESS
CONNECTIVITY

WIRELESS CONNECTIVITY

The GOLDEN cooktops are equipped with wireless technology which allows the transmission in real time of information on the use of the cooktop: active zones, cooking power and the presence of pots.



TEMPERATURE
MANAGER

TEMPERATURE MANAGER

The cooktop can be used with two programmes (107 or 161 F) to always ensure a perfect cooking. Temperature settings are optimized both for very delicate types of cooking (mousse, sauces, keeping food warm) or for cooking that requires high power (boiling).



BRIDGE ZONES

BRIDGE ZONES

The special Bridge Zones (2 zones for 36", 1 zone for 30" and 24") can work both individually or combined for a more homogeneous cooking using both baking pans and large pots. Thanks to this technology it is the cooktop surface that adapts itself to the type of pots being used.



POT
DETECTOR

POT DETECTOR

Elica induction cooktops automatically detect the presence of pots on the cooking zones, in order to facilitate cooking, avoiding tedious steps and energy waste: just place the pot and directly select the desired power level.



STOP&GO

STOP&GO

Stop&Go allows you to switch the cooktop off, and then to quickly restart working at the same temperature.





- 1** TOUCH CONTROL
THE TOUCH CONTROLS ALLOW YOU TO EASILY AND INDEPENDENTLY CONTROL THE COOKING ZONES, AND THANKS TO THE INDICATORS THAT SHOW THE SET POWER LEVEL, EACH ZONE IS VERY SIMPLE TO MONITOR.
- 2** POWER BOOSTER
THE POWER BOOSTER FUNCTION ENABLES MORE POWER TO BE RELEASED AND ACCELERATES THE HEATING TIME OF EACH COOKING ZONE, SUCH AS BRINGING TO BOIL MORE QUICKLY BIGGER WATER QUANTITIES.
- 3** RESIDUAL HEAT INDICATOR
SPECIAL LIGHTS WARN IF THE COOKING ZONE IS STILL WARM, EVEN AFTER THE COOKTOP HAS BEEN SWITCHED OFF.
- 4** TIMER
THANKS TO THE PROGRAMMABLE TIMER, IT IS POSSIBLE TO MANAGE EACH PREPARATION/ COOKING TIME. WHEN DONE, THE COOKTOP WILL GIVE OFF AN ACOUSTIC WARNING AND AUTOMATICALLY SWITCH OFF THE COOKING ZONE CONCERNED.
- 5** SAFE ACTIVATION & CHILD LOCK
WITH GOLDEN, THE KITCHEN IS SAFER: THE COOKTOPS ONLY SWITCH ON WHEN POTS ARE PRESENT ON THE COOKING ZONES, AND THE CHILD LOCK PREVENTS CHILDREN FROM ACCIDENTLY SWITCHING ON THE COOKTOP, BY BLOCKING EVERY FUNCTION.
- 6** COLD SURFACE
WITH INDUCTION TECHNOLOGY, ONLY THE BOTTOM OF THE POT IS HEATED, WHILE THE REST OF THE COOKTOP SURFACE REMAINS COOL.
- 7** 9 POWER LEVEL
YOU CAN CHOOSE FROM NINE DIFFERENT POWER LEVELS IN A VERY QUICK AND INTUITIVE WAY, THUS MEETING ANY TYPE OF COOKING NEED.
- 8** AUTOMATIC HEAT UP
THE COOKTOP AUTOMATICALLY HEATS UP AT MAXIMUM POWER AND RESTORES THE LEVEL SELECTED AFTER A CERTAIN PERIOD OF TIME.
- 9** SAFETY SHUTDOWN
THE PAUSE FEATURE ALLOWS YOU TO SWITCH THE COOKTOP OFF AND THEN TO QUICKLY RESTART WORKING AT THE SAME TEMPERATURE. WHEN THE PAUSE FEATURE IS ENABLED, THE COOKING ZONE KEEPS A CONSTANT LOW TEMPERATURE.



INDUCTION COOKTOP AND YOU

WHY THE INDUCTION COOKTOP?

Induction cooktops are becoming increasingly common in the kitchen: they represent the perfect combination of performance, functionality and look, while at the same time guaranteeing maximum safety in all types of cooking.

GOLDEN INDUCTION COOKTOPS IN YOUR KITCHEN: PERFORMANCE, FUNCTIONALITY, SAFETY AND DESIGN.

Elica's Golden induction cooktops improve and simplify all kinds of cooking, guaranteeing precision and uniformity of the end result in far less time than traditional cooktops. They also ensure:

- 1 REDUCTION OF COOKING TIME
The induction technique means that heat is generated directly on the pot, greatly reducing cooking time while keeping the temperature constant and uniform over the whole surface.

MAXIMUM SAFETY

HOW TO CHOOSE IT

Choose the Elica induction cooktop that integrates perfectly with your kitchen, providing aesthetic enhancement while allowing you to cook in optimal conditions, saving time and ensuring excellent cooking quality.

Choose the cooktop in relation to the size of your work surface, ranging from a minimum of 24 inches to a maximum of 35 inches.
FOR THOSE WHO LOVE COOKING,

- 2 The cooking area is activated only upon contact with the pot, leaving the remainder of the cooktop surface cold, thus guaranteeing maximum safety and avoiding energy waste.

- 3 FLEXIBILITY
Induction cooktops allow a larger cooking area to be used, ensuring maximum flexibility.

- 4 EASY USAGE
For every kitchen requirement, use is easy and direct: just a simple touch to adjust power and temperature in each zone.

- 5 ELICA DESIGN
Decorative, efficient, and easy to clean, Elica's Golden induction cooktops satisfy all your kitchen cooking demands.



1

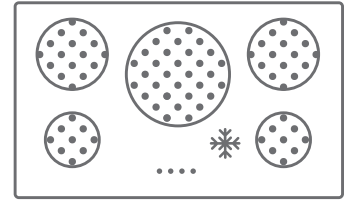

2

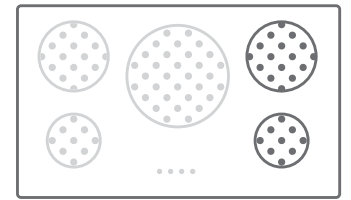

3

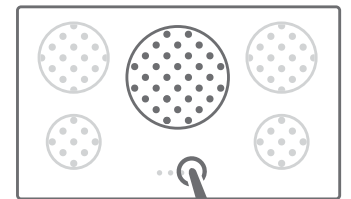

4

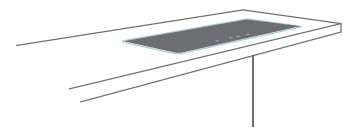

5

ELICA'S GOLDEN Cooktops REPRESENT THE IDEAL SOLUTION TO ENHANCE CREATIVITY AND INCREASE POSSIBILITY.

Thanks to the bridge zone, pans of any size can be freely positioned within the induction cooktop's two large rectangular cooking zones.



HOW TO INSTALL IT

BEFORE INSTALLING YOUR COOKTOP, PLEASE REMEMBER THE FOLLOWING SUGGESTIONS:

- Follow all the steps indicated in the instruction manual;
- Verify that all size requirements are respected in order to obtain optimal performance without harming other kitchen cupboards;
- Check that the position of the electrical socket is close to the cooktop;
- Should any difficulties arise, request the intervention of a reliable specialist technician.

Golden induction cooktops allow different installation modes:

- 6 STANDARD INSTALLATION**
 Standard installation of the frameless induction cooktop involves direct placement of the glass on the work surface.
- 7 FLUSH MOUNT INSTALLATION**
 With flush mount installation, the induction cooktop is inserted in a compartment of 0.039 inches, with no perimeter edge and completely flush with the work surface.

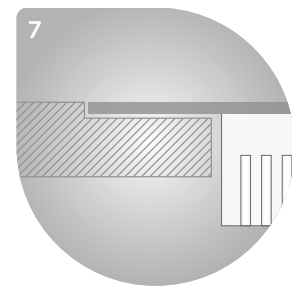
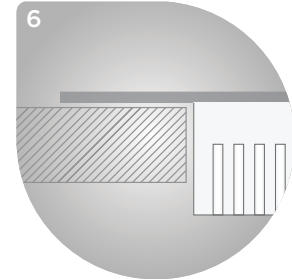

TAKING CARE OF IT

ELICA'S GOLDEN INDUCTION COOKTOPS ARE DESIGNED AND MANUFACTURED TO ENSURE OPTIMUM LONG-LIFE OPERATION.

Thanks to the perfectly smooth surface and the special glass-ceramic material, cleaning is extremely quick and easy: just use a soft cloth and a mild detergent.

TECHNE PLUS

THE TECHNE PLUS PRODUCT SERIES INCLUDE RANGE HOODS EQUIPPED WITH SENSORS THAT MEASURE TEMPERATURE AND MOISTURE PLUS WIRELESS TECHNOLOGY THAT COMMUNICATES WITH AN ELICA INDUCTION COOKTOPS. THE RESULT IS AN AUTOMATIC HOOD THAT DELIVERS OPTIMUM PERFORMANCE AND UNPARALLELED CONVENIENCE.





All pictures shown are for illustration purpose only. Actual product may vary due to product enhancement.



METEORITE

ELICA DESIGN CENTER



A NEW GENERATION OF SMART SYSTEM, CONNECTING HOODS AND COOKTOPS

Black glass and polished stainless steel. Like all of the hoods in the Elica TECHNE PLUS line, also Meteorite is meant for anyone who loves high-technological solutions, where Elica hoods and cooktops, automatically communicate with one another, recognizing quality and quantity of cooking vapors, thus accordingly adjusting performance levels. With Perimeter Aspiration technology helps achieve Top Performance by delivering more powerful and efficient fume extraction plus it reduces noise. Meteorite includes a powerful 550 CFM blower, Strip LED lighting and tunable white with glass capacitive touch controls.



Reference image only.

METEORITE

ELICA DESIGN CENTER

Size	36"
Dimensions	36"W x 17 1/8"D x 2 3/8"H
Mounting type	Wall-Mount
Type Finish	Stainless Steel + Black Glass
Installation Type	Ducted Installation Only



WIRELESS CONNECTIVITY



TOP PERFORMANCE



PERIMETER ASPIRATION



LONG LIFE FILTER



AMBIENT LIGHT



LED LIGHT



TOUCH CONTROL



Controls	Touch Controls 3 Speed + Booster (Sensor)
Illumination	Strip LED 7 Watts 2700 - 6000K - Tunable White
Blower Type	550 CFM (4-speed)
Noise (sones)	Min: 1.7, Max: 7.0
Blower Performance	Speed 1, 192 CFM Speed 2, 310 CFM Speed 3, 450 CFM Speed 4, 550 CFM
Electrical	120 V - 60 Hz 460 Watt at 3.8 Amp
Duct transition	6" Round with Back Draft Damper (Top Round 6")

Dishwasher-Safe, Aluminum Grease Filter, Perimeter Aspiration

ACCESSORIES

Optional Recirculating Kit	CODE: KIT0120949
Optional Remote Control	CODE: KIT0121468

CONSUMABLE PARTS

Charcoal Filter Replacement	CODE: KIT0121493
Grease Filter Replacement	CODE: GRI0120150A

MODELS

METEORITE 36" SS	EMT636SS
------------------	----------





ELICA
METEORITE
ISLAND

ELICA DESIGN CENTER

STYLE AND
MAXIMUM
EFFICIENCY

Black glass and polished stainless steel in its island version, like all of the hoods in the ELICA TECHNE PLUS line, Meteorite ISLAND is meant for anyone who loves high-technological solutions, where Elica hoods and cooktops, automatically communicate with one another, recognizing quality and quantity of cooking vapors, thus accordingly adjusting performance levels. With Perimeter Aspiration technology helps achieve Top Performance by delivering more powerful and efficient fume extraction plus it reduces noise. Meteorite ISLAND includes a powerful 550 CFM blower, Strip LED lighting and tunable white with glass capacitive touch controls.



Reference image only.

METEORITE ISLAND

ELICA DESIGN CENTER

Size	48"
Dimensions	48"W x 24"D x 28"H
Mounting type	Island
Type Finish	Stainless Steel + Black Glass
Installation Type	Ducted or Recirculating

Controls	Touch Controls 3 Speed + Booster (Sensor)
Illumination	Strip LED 7 watts 2700 - 6000K, Tunable White
Blower Type	550 CFM (4-speed)
Noise (sones)	Min: 1.7, Max: 7.0
Blower Performance	Speed 1, 192 CFM Speed 2, 310 CFM Speed 3, 450 CFM Speed 4, 550 CFM
Electrical	120 V - 60 Hz 460 Watt at 3.8 Amp
Duct transition	6" Round with Back Draft Damper (Top Only)

Dishwasher-Safe, Aluminum Grease Filter, Perimeter Aspiration

ACCESSORIES

Optional Recirculating Kit	CODE: KIT0120949
----------------------------	------------------

CONSUMABLE PARTS

Charcoal Filter Replacement	CODE: KIT0121493
Grease Filter Replacement	CODE: GRI0120150A

MODELS

METEORITE ISLAND 48" SS	EMI648SS
-------------------------	----------



≥24"



≥30"



WIRELESS CONNECTIVITY



TOP PERFORMANCE



AMBIENT LIGHT



PERIMETER ASPIRATION



LED LIGHT



LONG LIFE FILTER



TOUCH CONTROL





STONEY

ELICA DESIGN CENTER

THE PERFECT
MARRIAGE
OF ELEGANCE,
EFFICIENCY AND
TECHNOLOGY



The pairing of glass, with hidden touch controls and brilliant stainless steel, make it ideal for any kitchen and will blend perfectly with other appliances. Perimeter Aspiration technology helps achieve Top Performance by delivering more powerful and efficient fume extraction plus it reduces noise. With dimmable LED lighting, users can adjust the brightness of the light to match other lighting in the room, which helps create the perfect atmosphere. Most innovative of all, STONEY will operate automatically through a wireless technology that senses when the burner is turned on, plus constantly measures temperature and moisture. Data is analyzed and the hood self-adjusts to the optimum speed.



Reference image only.

STONEY

ELICA DESIGN CENTER



Size	30" - 36"
Dimensions	30"W x 19 7/8"D x 5"H 36"W x 19 7/8"D x 5"H
Mounting type	Wall-Mount
Type Finish	Black Stainless Steel + Black Glass
Installation Type	Ducted or Recirculating



Controls	Touch Controls 3 Speed + Booster (Sensor)
Illumination	2 Premium LED Dimmable Lights, 2.5 watts
Blower Type	600 CFM (4-speed)
Noise (sones)	Min: 1.53, Max: 6.0
Blower Performance	Speed 1, 160 CFM Speed 2, 280 CFM Speed 3, 470 CFM Speed 4, 600 CFM
Electrical	120 V - 60 Hz 530 Wattage
Duct transition	6" Round with Back Draft Damper (Top Only)

Dishwasher-Safe, Aluminum Grease Filter-Perimeter Aspiration

ACCESSORIES	
Optional Long Chimney Extension Kit (8'8"-12.4" ducted / 9'0"-12'8" recirculating)	CODE: KIT02785
Optional Recirculating Kit	CODE: KIT0141925

MODELS	
STONEY 30" SS	EST630SS
STONEY 36" SS	EST636SS



STONEY ISLAND

ELICA DESIGN CENTER

THE DESIGN IS PURE ELEGANCE

STONEY ISLAND is part of the Elica TECHNE PLUS product line, where hoods can operate automatically thanks to a wireless sensor technology that detects activity on the cooktop and constantly monitors temperature and moisture.

The hood self adjusts the blower speed to the optimum setting without user involvement. The hood design projects pure elegance through the marriage of bright stainless steel, glass, face plate and hidden electronic controls. The hood is equipped with Perimeter Aspiration technology which achieves top ventilating performance and lower sound levels. With the dimmable LED lights, it is possible to adjust the brightness of the lighting to create the perfect atmosphere.



Reference image only.

STONEY ISLAND

ELICA DESIGN CENTER



Size	36" - 42"
Dimensions	36"W x 27"D x 5"H 42"W x 27"D x 5"H
Mounting type	Island
Type Finish	Stainless Steel + Black Glass
Installation Type	Ducted or Recirculating



Controls	Touch Control 3S + Booster (Sensor)
Illumination	4 LED Premium Dimmable Lights, 2.5 watts
Blower Type	600 CFM (4-speed)
Noise (sones)	Min: 1.46, Max: 6.0
Blower Performance	Speed 1, 180 CFM Speed 2, 300 CFM Speed 3, 470 CFM Speed 4, 600 CFM
Electrical	120 V - 60 Hz 530 Wattage
Duct transition	6" Round with Back Draft Damper (Top Only)

Dishwasher Safe, Aluminum Grease Filter, Perimeter Aspiration

ACCESSORIES

Optional Long Chimney Extension Kit (9'0"-12'10" ducted / 9'4"-13" recirculating)	CODE: KIT0100317
Optional Recirculating Kit	CODE: KIT0141924

MODELS

STONEY ISLAND 36" SS	ES1636SS
STONEY ISLAND 42" SS	ES1642SS



TECHNE

TECHNE SERIES BRING EVERYDAY ITALIAN LIVING INTO YOUR KITCHEN, FEATURING INSPIRATIONAL CLASSIC ITALIAN DESIGN, THAT ARE LOADED WITH FUNCTIONAL TECHNOLOGIES THAT DELIVER CONVENIENCE AND HIGH PERFORMANCE. THE HOODS COME EQUIPPED WITH POWERFUL BLOWERS, HUSH SOUND SUPPRESSION SYSTEM, ELEGANT GLASS TOUCH CONTROLS, DURABLE STAINLESS STEEL MICROHOLE FILTERS AND SET THE RIGHT ILLUMINATION MOOD WITH LONG LIFE LED LIGHTING WHERE COLOR AND BRIGHT CAN BE ADJUSTED AND DIMMED.





All pictures shown are for illustration purpose only. Actual product may vary due to product enhancement.

COMO

ELICA DESIGN CENTER

COMO combines arched glass wings and stainless steel to create a light and airy environment: the perfect centerpiece for any contemporary kitchen. Como has a glass touch panel with hidden controls when the power is off, plus LED dimmable lighting and dishwasher-safe stainless steel microhole filters that deliver elegance and efficiency. HUSH Sound Suppression reduces sound up to 35% and HeatGuard technology detects excessive heat and automatically adjusts blower speed. COMO can also be installed as a recirculating system using the available Recirculating Kit.



THE PERFECT CENTERPIECE FOR
CONTEMPORARY KITCHENS.



Reference image only.

COMO

ELICA DESIGN CENTER

Size	30" - 36"
Dimensions	30"W x 19 11/16"D x 1 15/16"H 36"W x 19 11/16"D x 1 15/16"H
Mounting type	Wall-Mount
Type Finish	Stainless Steel + Black Glass
Installation Type	Ducted or Recirculating



≥24"



≥30"



CFM REDUCTION



DIM LIGHT



HUSH SYSTEM



AMBIENT LIGHT



TOP PERFORMANCE



TOUCH CONTROL



LED LIGHT



Controls	Touch Controls 3 Speed + Booster
Illumination	2 Premium LED Dimmable Lights, 2.5 watts
Blower Type	600 CFM (4-speed)
Noise (sones)	Min: 2.36, Max: 6.0
Blower Performance	Speed 1, 160 CFM Speed 2, 280 CFM Speed 3, 470 CFM Speed 4, 600 CFM
Electrical	120 V - 60 Hz 530 Wattage
Duct transition	6" Round with Back Draft Damper (Top Only)

Dishwasher-Safe, Stainless Steel Microhole Filter

ACCESSORIES

Optional Long Chimney Extension Kit (8'5"-12'1"ducted / 9'2"-12'5"recirculating)	CODE: KIT0100315
Optional Recirculating Kit	CODE: KIT02721

MODELS

COMO 30" SS	ECM630S3
COMO 36" SS	ECM636S3



See page 125



CINGOLI

ELICA DESIGN CENTER

elica

Cingoli takes flight with graceful arched glass wings, complemented by reflective stainless steel. Cingoli has premium LED dimmable lighting, dishwasher-safe stainless steel microhole filters plus glass touch controls that are hidden when the hood is off. It's also equipped with HUSH Sound Suppression System that reduces sound up to 35%, allowing you to comfortably cook and entertain at the same time. Cingoli can also be installed as a recirculating system using the available Recirculating Kit.

Reference image only.

elica





CINGOLI

ELICA DESIGN CENTER



≥24"



≥30"



CFM REDUCTION



DIM LIGHT



HUSH SYSTEM



AMBIENT LIGHT



TOP PERFORMANCE



TOUCH CONTROL



LED LIGHT

Size	36" - 42"
Dimensions	36"W x 25 3/16"D x 1 15/16"H 42"W x 25 3/16"D x 1 15/16"H
Mounting type	Island
Type Finish	Stainless Steel + Black Glass
Installation Type	Ducted or Recirculating



Controls	Touch Controls 3 Speed + Booster
Illumination	2 Premium LED Dimmable Lights, 2.5 watts
Blower Type	600 CFM (4-speed)
Noise (sones)	Min: 2.36, Max: 6.0
Blower Performance	Speed 1, 160 CFM Speed 2, 280 CFM Speed 3, 470 CFM Speed 4, 600 CFM
Electrical	120 V - 60 Hz 530 Wattage
Duct transition	6" Round with Back Draft Damper (Top Only)

1 Dishwasher-Safe, Stainless Steel Micro Hole Grease Filter

ACCESSORIES

Optional Long Chimney Extension Kit (8'9"-12'1" ducted / 9'2"-12'9" recirculating)	CODE: KIT0100317
Optional Recirculating Kit	CODE: KIT02665

MODELS

CINGOLI 36" SS	ECN636S3
CINGOLI 42" SS	ECN642S3



See page 125



MEZZANO

ELICA DESIGN CENTER

With a “minimalist” hood design that’s only 2” high, the stainless steel Mezzano is in step with today’s world of flat-panel TVs and other futuristic products with clean, architectural lines.

MEZZANO has LED dimmable lighting, stainless steel microhole filters and glass touch controls that are hidden when the hood is off. It’s also equipped with HUSH Sound Suppression that reduces sound up to 35%, allowing you to comfortably cook and entertain at the same time.

MEZZANO can also be installed as a recirculating system using the available Recirculating Kit.

Reference image only.



MEZZANO

ELICA DESIGN CENTER



≥27"



≥30"



CFM REDUCTION



DIM LIGHT



HUSH SYSTEM



AMBIENT LIGHT



TOP PERFORMANCE



TOUCH CONTROL



LED LIGHT

Size	30" - 36"
Dimensions	30"W x 19 11/16"D x 1 9/16"H 36"W x 19 11/16"D x 1 9/16"H
Mounting type	Wall-Mount
Type Finish	Stainless Steel + Black Glass
Installation Type	Ducted or Recirculating



Controls	Touch Controls 3 Speed + Booster
Illumination	2 Premium LED Dimmable Lights, 2.5 watts
Blower Type	600 CFM (4-speed)
Noise (sones)	Min: 1.73, Max: 6.0
Blower Performance	Speed 1, 160 CFM Speed 2, 280 CFM Speed 3, 470 CFM Speed 4, 600 CFM
Electrical	120 V - 60 Hz 490 Wattage
Duct transition	6" Round with Back Draft Damper (Top Only)

Dishwasher-Safe, Stainless Steel Microhole Grease Filter

ACCESSORIES

Optional Long Chimney Extension Kit (8'6"-12'2"ducted / 8'10"-12'6"recirculating)	CODE:KIT02785
Optional Recirculating Kit	CODE:KIT0102875

MODELS

MEZZANO 30" SS	EMZ630S3
MEZZANO 36" SS	EMZ636S3

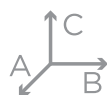

See page 125



The clean lines and beautifully sloping angles of Varna Black are an Italian classic that will compliment any kitchen. Elica's new black stainless provides a uniquely rich appearance and naturally hides finger prints. VARNA BLACK has LED dimmable lighting, stainless steel microhole filters and glass touch controls that are hidden when the hood is off. It's also equipped with HUSH Sound Suppression that reduces sound up to 35%, allowing you to comfortably cook and entertain at the same time. VARNA BLACK can also be installed as a recirculating system using the available Recirculating Kit.

VARNA BLACK

Reference image only.

ELICA DESIGN CENTER

VARNA BLACK

ELICA DESIGN CENTER

Size	30" - 36"
Dimensions	30"W x 19 11/16"D x 10 1/4"H 36"W x 19 11/16"D x 10 1/4"H
Mounting type	Wall-Mount
Type Finish	Black Stainless Steel + Black Glass
Installation Type	Ducted or Recirculating



≥27"



≥30"

CFM
REDUCTION

DIM LIGHT

HUSH
SYSTEM

AMBIENT LIGHT

TOP
PERFORMANCETOUCH
CONTROL

LED LIGHT



Controls	Touch Controls 3 Speed + Booster
Illumination	2 Premium LED Dimmable Lights, 2.5 watts
Blower Type	600 CFM (4-speed)
Noise (sones)	Min: 1.93, Max: 6.0
Blower Performance	Speed 1, 160 CFM Speed 2, 280 CFM Speed 3, 475 CFM Speed 4, 600 CFM
Electrical	120 V - 60 Hz 490 Wattage
Duct transition	6" Round with Back Draft Damper (Top Only)

Dishwasher-Safe, Anodized Aluminum Mesh (2w/30" & 3w/36")

ACCESSORIES

Optional Long Chimney Extension Kit (8'5"-11'3"ducted / 8'6"-11'7"recirculating)	CODE: KIT0140998
Optional Recirculating Kit	CODE: KIT02766

MODELS

VARNA BLACK 30" BSS	EVR630BL
VARNA BLACK 36" BSS	EVR636BL



See page 125





Reference image only.

VARNA

ELICA DESIGN CENTER

See page 125 



>27"



≥30"



TOP PERFORMANCE



HUSH SYSTEM



CFM REDUCTION



DIM LIGHT



LED LIGHT



TOUCH CONTROL

Size	30" - 36"
Dimensions	30"W x 19 11/16"D x 10 1/4"H 36"W x 19 11/16"D x 10 1/4"H
Mounting type	Wall-Mount
Type Finish	Stainless Steel + Black Glass
Installation Type	Ducted or Recirculating
Controls	Touch Controls 3 Speed + Booster
Illumination	2 Premium Dimmable Lights, 2.5 watts
Blower Type	600 CFM (4-speed)
Noise (sones)	Min: 1.93, Max: 6.0
Blower Performance	Speed 1, 160 CFM Speed 2, 280 CFM Speed 3, 475 CFM Speed 4, 600 CFM
Electrical	120 V - 60 Hz 340 Wattage
Duct transition	6" Round with Back Draft Damper (Top Only)

Dishwasher-Safe, Anodized Aluminum Mesh (2w/30" & 3w/36")

ACCESSORIES

Optional Long Chimney Extension Kit (8'5"-11'3" ducted / 8'6"-11'7" recirculating) CODE: KIT02762

Optional Recirculating Kit CODE: KIT02766

MODELS

VARNA 30" SS EVR630S2
VARNA 36" SS EVR636S2

FOGLIA

ELICA DESIGN CENTER



Reference image only.

elica



FOGLIA
ELICA DESIGN CENTER

See page 125 



Size Dimensions	30" - 36" 30"W x 20"D x 10"H 36"W x 20"D x 10"H
Mounting type	Wall-Mount
Type Finish	Stainless Steel + Black Glass
Installation Type	Ducted or Recirculating
Controls	Touch Controls 3 Speed + Booster
Illumination	2 Premium LED Dimmable Lights, 2.5 watts
Blower Type	600 CFM (4-speed)
Noise (sones)	Min: 1.71, Max: 7.5
Blower Performance	Speed 1, 210 CFM Speed 2, 300 CFM Speed 3, 470 CFM Speed 4, 600 CFM
Electrical	120 V - 60 Hz 490 Wattage
Duct transition	6" Round with Back Draft Damper (Top Only)

Dishwasher-Safe, Stainless Steel Micro Hole Grease Filter

ACCESSORIES	
Optional Long Chimney Extension Kit (8'5"-11'3" ducted / 8'7"-11'7" recirculating)	CODE: KIT02784
Optional Recirculating Kit	CODE: KIT02766

MODELS	
FOGLIA 30" SS	EFG630S1
FOGLIA 36" SS	EFG636S1



ARIA is an ideal choice where under-cabinet space is limited. Its upgraded 4-speed, internal blower provides sufficient ventilating power for most kitchens. Bellagio also offers premium LED dimmable lighting, Baffle Slot stainless steel filters, glass touch controls that are hidden when the hood is off. Also comes equipped with HeatGuard technology which automatically increases blower speed when excessive heat is detected. ARIA can also be used as a recirculating system, when using the available kit.



Reference image only.



ARIA

ELICA DESIGN CENTER

Size	30" - 36" 30" W x 20" D x 4 3/4" H 36" W x 20" D x 4 3/4" H
Mounting type	Under-Cabinet
Type Finish	Stainless Steel + Black Glass
Installation Type	Ducted or Recirculating



Controls	Touch Control 3 Speed + Booster
Illumination	2 Premium LED Dimmable Lights, 2.5 watts
Blower Type	430 CFM (4-speed)
Noise (sones)	Min: 1.1, Max: 4.7
Blower Performance	Speed 1, 160 CFM Speed 2, 240 CFM Speed 3, 310 CFM Speed 4, 430 CFM
Electrical	120 V - 60 Hz 445 Wattage
Duct transition	3 1/4" x 10" with Back Draft Damper (Top or Rear)

2 Dishwasher-Safe, Stainless Steel Baffle Slot Filter

ACCESSORIES

Optional Recirculating Kit 30"	CODE: KIT02178
Optional Recirculating Kit 36"	CODE: KIT02179
Optional Backdraft Damper 7" round	CODE: KIT02723

MODELS

ARIA 30" SS	EAI430SS
ARIA 36" SS	EAI436SS

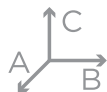

See page 125



MODENA 
ELICA DESIGN CENTER



Reference image only.

MODENA

ELICA DESIGN CENTER

See page 125 



≥24"



≥30"



CFM REDUCTION



DIM LIGHT



AMBIENT LIGHT



LED LIGHT



TOUCH CONTROL



HUSH SYSTEM

Size	30" - 36"
Dimensions	30"W x 20"D x 9"H 36"W x 20"D x 9"H
Mounting type	Under-Cabinet
Type Finish	Stainless Steel + Black Glass
Installation Type	Ducted or Recirculating
Controls	Touch Control 3 Speed + Booster
Illumination	2 Premium LED Dimmable Lights, 2.5 watts
Blower Type	530 CFM(4-speed)
Noise (sones)	Min: 1.73, Max: 6.0
Blower Performance	Speed 1, 170 CFM Speed 2, 280 CFM Speed 3, 430 CFM Speed 4, 520 CFM
Electrical	120 V - 60 Hz 550 Wattage
Duct transition	3 1/4" x 10" with Back Draft Damper (Top or Rear)

Dishwasher-Safe, Stainless Steel Microhole Grease Filter

ACCESSORIES

Optional Recirculating Kit CODE: KIT02667

MODELS

MODENA 30" SS	EMD530S3
MODENA 36" SS	EMD536S3



BELLAGIO

ELICA DESIGN CENTER





Reference image only.

BELLAGIO

ELICA DESIGN CENTER

See page 125 



≥24"



≥30"



3X LAYER MESH FILTER



CFM REDUCTION



HEAT GUARD

Size	30" - 36"
Dimensions	30"W x 20"D x 4 3/4"H 36"W x 20"D x 4 3/4"H 30"W x 20"D x 4 3/4"H
Mounting type	Under-Cabinet
Type Finish	Stainless Steel
Installation Type	Ducted or Recirculating
Controls	Multi-function Electronic with LCD Display
Illumination	2 Halogen, 50 watts
Blower Type	430 CFM (4-speed)
Noise (sones)	Min: 1.4, Max: 7.1
Blower Performance	Speed 1, 160 CFM Speed 2, 240 CFM Speed 3, 310 CFM Speed 4, 430 CFM
Electrical	120 V - 60 Hz 445 Wattage
Duct transition	3 1/4" x 10" with Back Draft Damper (Top or Rear)

2 Dishwasher-Safe, Anodized Aluminum Mesh Grease Filter

ACCESSORIES

Optional Backdraft Damper 7" round - 30"	CODE: KIT02723
Optional Backdraft Damper 7" round - 36"	CODE: KIT02723
Optional Recirculating Kit 30"(Carbon filter)	CODE: KIT02178
Optional Recirculating Kit 36"(Carbon filter)	CODE: KIT02179

MODELS

BELLAGIO 30" SS	EBL430SS
BELLAGIO 36" SS	EBL436SS
BELLAGIO 30" White	EBL430WT

PILATO 
ELICA DESIGN CENTER

 elica



Reference image only.

 elica



PILATO

ELICA DESIGN CENTER

See page 125 



CFM
REDUCTION



HEAT GUARD

Size	30" - 36"
Dimensions	30"W x 21 1/2"D x 10 1/4"H 36"W x 21 1/2"D x 10 1/4"H
Mounting type	Wall-Mount
Type Finish	Stainless Steel
Installation Type	Ducted or Recirculating
Controls	Multi-function Electronic with LCD Display
Illumination	2 Halogen Lamps, 40 watts
Blower Type	600 CFM(4-speed)
Noise (sones)	Min: 1.7, Max: 8.2
Blower Performance	Speed 1, 160 CFM Speed 2, 280 CFM Speed 3, 475 CFM Speed 4, 600 CFM
Electrical	120 V - 60 Hz 530 Wattage
Duct transition	6" Round with Back Draft Damper (Top Only)

Dishwasher-Safe, Anodized Aluminum Mesh (2w/30" & 3w/36")

ACCESSORIES

Optional Recirculating Kit for 30" and 36"	CODE: KIT02766
Optional Long Chimney Extension Kit Reaches 8'11" - 11'4" (ducted) / 9'3" - 11'8" (recirculating)	CODE: KIT02762

MODELS

PILATO 30" STAINLESS	EPL630S1
PILATO 36" STAINLESS	EPL636S1



OUT OF SIGHT POWER

Palermo provides top performance, while its 28 1/4" width and 10 3/4" depth enables it to be discreetly installed within standard 12" deep cabinetry, making it ideal for smaller kitchens or where the range hood needs to be out of sight. Palermo has a powerful 600 CFM blower to support most cooking needs. Stylish stainless steel push button controls operate a 3-speed blower and LED lighting.

Easy maintenance, higher efficiency and a cleaner kitchen are ensured by Elica's patented Baffle Slot Filters, which capture a higher percentage of grease and hold larger volumes of grease than traditional baffle filters. Palermo is designed for standard ducted or recirculating installation.

PALERMO 

ELICA DESIGN CENTER



Reference image only.

PALERMO

ELICA DESIGN CENTER

See page 125



≥24"



≥30"

SEMI BAFFLE
FILTER

LED LIGHT

HUSH
SYSTEM

Size	28"
Dimensions	28 1/4"W x 10 3/4"D x 9 1/4"H
Mounting type	Insert
Type Finish	Stainless Steel
Installation Type	Ducted or Recirculating
Controls	Stainless Steel Push Button
Illumination	2 Premium LED, 2.5 watts
Blower Type	600 CFM (3-speed)
Noise (sones)	Min: 2.1, Max: 6.0
Blower Performance	Speed 1, 190 CFM Speed 2, 350 CFM Speed 3, 600 CFM
Electrical	120 V - 60 Hz 260 Wattage
Duct transition	6" Round with BackDraft Damper (top only)

2 Dishwasher-Safe, Stainless Steel Baffle Slot Grease Filter
Stainless Steel Liner Kit Available in 30" or 36" widths

ACCESSORIES

Optional Hood Liner 30"	CODE:KIT02773
Optional Hood Liner 36"	CODE:KIT02774
Optional Recirculating Kit (Carbon filter)	CODE:KIT02770

MODELS

PALERMO 28" SS	EPR628S1
----------------	----------



RISE 
ELICA DESIGN CENTER



Reference image only.

RISE

ELICA DESIGN CENTER

Size	30" - 36"
Dimensions	30"W x 12 1/2"D x 14"H 36"W x 12 1/2"D x 14"H
Mounting type	Downdraft
Type Finish	Stainless Steel
Installation Type	Ducted Installation Only

Controls	Rotative Touch Control
Blower Type	600 CFM (4-speed)
Noise (sones)	Min: 1.9, Max: 8.0
Blower Performance	Speed 1, 205 CFM Speed 2, 350 CFM Speed 3, 510 CFM Speed 4, 600 CFM
Electrical	120 V - 60 Hz 410 Wattage
Duct transition	6" Round with Back Draft Damper (Side)

Perimeter Aspiration (Aluminum Mesh Filter Behind)

MODELS

RISE 30" STAINLESS STEEL	ERS630S1
RISE 36" STAINLESS STEEL	ERS636S1



See page 125



≡ LUGANO

ELICA DESIGN CENTER

Reference image only.



TECHNE

LUGANO

ELICA DESIGN CENTER



See page 125



Size Dimensions	30" - 36" 30"W x 19 11/16"D x 5"H 36"W x 19 11/16"D x 5"H
Mounting type	Wall-Mount
Type Finish	Stainless Steel + Black Glass
Installation Type	Ducted or Recirculating
Controls	Touch Controls 3 Speed + Booster
Illumination	2 Premium LED Dimmable Lights, 2.5 watts
Blower Type	600 CFM (4-speed)
Noise (sones)	Min: 2.03, Max: 8.0
Blower Performance	Speed 1, 160 CFM Speed 2, 280 CFM Speed 3, 470 CFM Speed 4, 600 CFM
Electrical	120 V - 60 Hz 530 Wattage
Duct transition	6" Round with Back Draft Damper (Top Only)

Aluminum Mesh Filter + Perimeter Aspiration

ACCESSORIES

Optional Long Chimney Extension Kit (8'8"-12'4" ducted / 9"-12'8" recirculating) CODE: KIT02785

Optional Recirculating Kit CODE: KIT014192S

MODELS

LUGANO 30" STAINLESS ELG630S3
LUGANO 36" STAINLESS ELG636S3



MAGGIORE

ELICA DESIGN CENTER

With a minimalist design but a strong stainless steel construction, Maggiore is in tune with avant-garde appliances where clear and architectural lines take precedence.

Maggiore has a powerful 600 CFM blower, LED dimmable lights, stainless steel micro hole filters and high-tech glass touch controls that deliver convenience and safety.

Maggiore was designed for standard ducted installation, but it can also be installed using the Recirculating Kit, available as an accessory.



Reference image only.

MAGGIORE

ELICA DESIGN CENTER

See page 125

CFM
REDUCTION

DIM LIGHT

TOUCH
CONTROLHUSH
SYSTEMTOP
PERFORMANCE

LED LIGHT

Size	36" - 42"
Dimensions	36"W x 19 11/16"D x 1 9/16" H 42"W x 19 11/16"D x 1 9/16" H

Mounting type	Island
---------------	--------

Type Finish	Stainless Steel + Black Glass
-------------	-------------------------------

Installation Type	Ducted or Recirculating
-------------------	-------------------------

Controls	Touch Controls 3 Speed + Booster
----------	----------------------------------

Illumination	4 Premium LED Dimmable Lights, 2.5 watts
--------------	--

Blower Type	600 CFM (4-speed)
-------------	-------------------

Noise (sones)	Min: 1.73, Max: 6.0
---------------	---------------------

Blower Performance	Speed 1, 160 CFM Speed 2, 280 CFM Speed 3, 470 CFM Speed 4, 600 CFM
--------------------	--

Electrical	120 V - 60 Hz 426.2 Wattage
------------	-----------------------------

Duct transition	6" Round with Back Draft Damper (Top only)
-----------------	--

3 Dishwasher-Safe, Stainless Steel Microhole Filter

ACCESSORIES

Recirculating Kit
(Contains 6" deflector & 2 Round Carbon Filters) CODE: KIT02665

Chimney Extension Kit
(Ducted 8'9" - 12'8" / Recirculating 9'2" - 12'9") CODE: KIT0100317

MODELS

MAGGIORE 36" STAINLESS	EMG636S1
MAGGIORE 42" STAINLESS	EMG642S1



SALICE

ELICA DESIGN CENTER



Salice conveys understated elegance with a gently tapered canopy that measures only 5" tall, which opens up the kitchen for entertainment and conversation. Available in 36" and 42" widths, Salice features a powerful 600 CFM blower, LED lights, stainless steel micro hole filters and Touch Controls

Designed for ducted installation, Salice can also be installed as a recirculating system using the Recirculating Kit, available as an accessory.

Reference image only.



TECHNE

SALICE

ELICA DESIGN CENTER

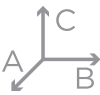

See page 125



Size Dimensions	36" - 42" 36"W x 27"D x 5"H 42"W x 27"D x 5"H
Mounting type	Island
Type Finish	Stainless Steel + Black Glass
Installation Type	Ducted or Recirculating
Controls	Touch Controls 3 Speed + Booster
Illumination	4 Premium LED Dimmable Lights, 2.5 watts
Blower Type	600 CFM (4-speed)
Noise (sones)	Min: 1.73, Max: 6.0
Blower Performance	Speed 1, 160 CFM Speed 2, 280 CFM Speed 3, 470 CFM Speed 4, 600 CFM
Electrical	120 V - 60 Hz 530 Wattage
Duct transition	6" Round with Back Draft Damper (Top Only)

Aluminum Mesh Filter + Perimeter Aspiration

ACCESSORIES

Optional Long Chimney Extension Kit (9'0"-12'10" ducted / 9'4"-13'0" recirculating)	CODE:KIT0100317
Optional Recirculating Kit	CODE:KIT0141924

MODELS

SALICE 36" STAINLESS	ESL636S3
SALICE 42" STAINLESS	ESL642S3

ELICA PRO

FOR THOSE INSPIRED BY THE CULINARY ARTS AND GOURMET COOKING, THE ELICA PRO SERIES OF RANGE HOODS DELIVER PROFESSIONAL STYLE COOKING, WITH BOLD DESIGNS COUPLED WITH UNPARALLELED DURABILITY, QUALITY AND HIGH PERFORMANCE THAT TOP CHEFS DESIRE.

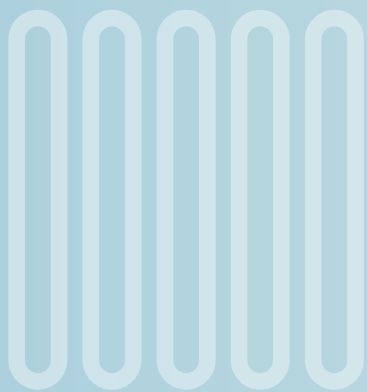

#POWER #FOODIES
#PROFESSIONALPERFORMANCE #PROFESSIONALDESIGN





All pictures shown are for illustration purpose only. Actual product may vary due to product enhancement.

LEONE 
ELICA DESIGN CENTER

FOR COOKING
LOVERS WITH A
PROFESSIONAL STYLE

Reference image only.



Give your professional kitchen a splash of Italian design with crisp lines, seamless welded corner craftsmanship, beveled rim and gleaming stainless steel. Most importantly, LEONE has the extra depth (24") and power (1200 CFM on 36", 42" & 48" widths) needed to support professional ranges and cooktops. No ear plugs required with LEONE's HUSH sound suppression system, which enables you to comfortably talk and entertain, even when cooking up a storm. Available in 30", 36" and 42" widths, LEONE features backlit hidden knob controls, which operate the 4-speed blower and LED lighting. Easy maintenance and a cleaner kitchen are assured with professional stainless steel baffle filters. LEONE is designed for standard ducted ventilation only.

LEONE

ELICA DESIGN CENTER



Size	30" - 36" - 42" - 48"
Dimensions	30"W x 24"D x 12 1/8"H 36"W x 24"D x 12 1/8"H 42"W x 24"D x 12 1/8"H 48"W x 24"D x 12 1/8"H
Mounting type	Wall-Mount
Type Finish	Stainless Steel
Installation Type	Ducted Installation Only
Controls	Fully Retractable Rotating Knobs w/ Blue Backlighting
Illumination	2 Consumer Replaceable LED, 7.5 watts
Blower Type	600 CFM (4-speed) - (30") 1200 CFM (4-speed) - (36", 42", 48")
Noise (sones)	Min: 2.01, Max: 6.0 (30") Min: 3.21, Max: 7.7 (36", 42", 48")
Blower Performance	Speed 1, 205 CFM (30") / 375 CFM (36", 42", 48") Speed 2, 350 CFM (30") / 640 CFM (36", 42", 48") Speed 3, 510 CFM (30") / 940 CFM (36", 42", 48") Speed 4, 600 CFM (30") / 1200 CFM (36", 42", 48")
Electrical	120 V - 60 Hz 800 Wattage
Duct transition	8" Round with Back Draft Damper (Top Only)
Dishwasher-Safe, Professional Stainless Steel Angled Baffle Filters 1w/30", 2w/36" & 42", 3w/48"	
ACCESSORIES	
Optional Long Chimney Extension Kit (9'3" - 13'0" over electric cooking / 9'9"-13'0" over gas cooking)	CODE: KIT02785
In Line Blower Kit 8" or 10" duct size compatible	CODE: KIT0154387
External Blower Kit 1200 CFMs 8" or 10"	CODE: KIT0153054
Make Up Air KIT 8"	CODE: KIT0148914
MODELS	
LEONE 30" STAINLESS	ELN630S2
LEONE 36" STAINLESS	ELN136S2
LEONE 42" STAINLESS	ELN142S2
LEONE 48" STAINLESS	ELN148S2



LEONE ISLAND

ELICA DESIGN CENTER



Designed to be suspended above a kitchen island, Leone's crisp lines, beveled rim and gleaming stainless steel deliver professional cooking with a sense of style. Give your kitchen a splash of Italian design with a chimney style island hood that has the extra depth and power required to support professional ranges and cooktops.

Available in 36" and 42" widths, Leone Island comes equipped with an extra powerful 1200 CFM internal blower and backlit hidden metallic in/out knobs, which operate the 4 speed blower and LED lighting.

Reference image only.



LEONE ISLAND

ELICA DESIGN CENTER

See page 125 



≥30"



≥30"



SEAMLESS LOOK



GREASE COLLECTORS



HEAT GUARD



LED REPLACEABLE



HUSH SYSTEM



PROFESSIONAL PERFORMANCE

Size	36" - 42"
Dimensions	36"W x 27"D x 12 3/4"H 42"W x 27"D x 12 3/4"H
Mounting type	Island
Type Finish	Stainless Steel
Installation Type	Ducted Installation Only
Controls	Fully Retractable Rotating Knobs w/ Blue Backlighting
Illumination	4 Consumable Replaceable LED, 7.5 watts
Blower Type	1200 CFM (4-speed) (1200 CFM Inline and External blowers available)
Noise (sones)	Min: 3.21, Max: 7.7
Blower Performance	Speed 1, 375 CFM Speed 2, 640 CFM Speed 3, 940 CFM Speed 4, 1200 CFM
Electrical	120 V - 60 Hz 800 Wattage
Duct transition	8" Round with Back Draft Damper (Top Only)

2 Dishwasher-Safe, 2 Professional Stainless Steel Angled Baffle Filter

ACCESSORIES

Optional Long Chimney Extension Kit (9'7" - 13'6" over electric cooking / 10'1" - 13'6" over gas cooking)	CODE: KIT0100317
In Line Blower Kit 8" or 10" duct size compatible	CODE: KIT0154387
External Blower Kit 1200 CFMs 8" or 10"	CODE: KIT0153054
Make Up Air KIT 8"	CODE: KIT0148914

MODELS

LEONE ISLAND 36" STAINLESS	ELI136S2
LEONE ISLAND 42" STAINLESS	ELI142S2

ELICA PRO



VAVANO

ELICA DESIGN CENTER



Give a splash of Italian design to your professional kitchen with Vavano's crisp lines, seamless welded corner craftsmanship, beveled rim and gleaming stainless steel. No ear plugs required with Vavano's HUSH sound suppression system, which enables you to comfortably talk and entertain, even when cooking up a storm. Available in 36" and 48" widths, Vavano features backlit hidden knob controls, which operate the 4-speed blower and LED lighting. Easy maintenance and cleaner kitchen are assured with professional stainless steel angled baffle filters.

Reference image only.



VAVANO

ELICA DESIGN CENTER

See page 125 



≥30"



≥30"



SEAMLESS LOOK



GREASE COLLECTORS



HEAT GUARD



LED REPLACEABLE



HUSH SYSTEM



PROFESSIONAL PERFORMANCE

Size	36" - 48"
Dimensions	36"W x 24"D x 5"H 48"W x 24"D x 5"H
Mounting type	Wall-Mount
Type Finish	Stainless Steel
Installation Type	Ducted Installation Only
Controls	Fully Retractable Rotating Knobs w/ Blue Backlighting
Illumination	2 Consumer Replaceable LED, 7.5 watts
Blower Type	600 CFM (4-speed) (1200 CFM Inline and External blowers available)
Noise (sones)	Min: 3.21, Max: 7.7
Blower Performance	Speed 1, 205 CFM Speed 2, 350 CFM Speed 3, 510 CFM Speed 4, 600 CFM
Electrical	120 V - 60 Hz 480 Wattage
Duct transition	8" Round with Back Draft Damper (Top Only)

Dishwasher-Safe, Professional Stainless Steel Angled Baffle Filters 2w/36", 3w/48"

ACCESSORIES

Optional Long Chimney Extension Kit (9'0" - 13'6" over electric cooking / 9'6" - 13'6" over gas cooking)	CODE: KIT0146881
In Line Blower Kit 8" or 10" duct size compatible	CODE: KIT0154387
External Blower Kit 1200 CFMs 8" or 10"	CODE: KIT0153054
Make Up Air KIT 8"	CODE: KIT0148914

MODELS

VAVANO 36" STAINLESS	EVV636S1
VAVANO 48" STAINLESS	EVV648S1



VAVANO ISLAND

ELICA DESIGN CENTER

ROBUST AND
MINIMALIST
AT ONCE

Professional grade island hood with a robust and minimalist at once hood design, that's only 6" tall. The design is complimented by a stylish beveled front rim design and metal rotating knob controls that fully recess Out-of-Sight for a super slim appearance. Plus Elica's branding is hidden for easy coordination with other appliances. VAVANO ISLAND has the extra depth to 27" and 1200 CFM's power to support professional ranges and cooktops. Entertain and enjoy the conversation, knowing Elica's patented HUSH Sound Suppression System is reducing sound up to 35%. Easy maintenance and a cleaner kitchen are assured with long life LED lighting plus professional stainless steel baffle filters.

Reference image only.



VAVANO ISLAND

ELICA DESIGN CENTER

See page 125 



Size Dimensions	42" - 48" 42"W x 24"D x 5"H 48"W x 24"D x 5"H
Mounting type	Island
Type Finish	Stainless Steel
Installation Type	Ducted Installation Only
Controls	Fully Retractable Rotating Knobs w/ Blue Backlighting
Illumination	4 Consumer Replaceable LED, 7.5 watts
Blower Type	600 CFM (4-speed) (1200 CFM Inline and External blowers available)
Noise (sones)	Min: 3.21, Max: 7.7
Blower Performance	Speed 1, 205 CFM Speed 2, 350 CFM Speed 3, 510 CFM Speed 4, 600 CFM
Electrical	120 V - 60 Hz 480 Wattage
Duct transition	8" Round with Back Draft Damper (Top Only)
Dishwasher-Safe, 3 Professional Stainless Steel Angled Baffle Filters	
ACCESSORIES	
Optional Long Chimney Extension Kit (8'11" - 13'0" over electric cooking / 9'5" - 13'0" over gas cooking)	CODE: KIT0145610
In Line Blower Kit 8" or 10" duct size compatible	CODE: KIT0154387
External Blower Kit 1200 CFMs 8" or 10"	CODE: KIT0153054
Make Up Air Kit 8"	CODE: KIT0148914
MODELS	
VAVANO ISLAND 42" STAINLESS	EVI642S1
VAVANO ISLAND 48" STAINLESS	EVI648S1

CALABRIA

ELICA DESIGN CENTER



FOR COOKING
LOVERS WITH A
PROFESSIONAL STYLE.

Reference image only.

For home owners who are passionate about the culinary arts, the stainless steel CALABRIA hood provides the look, performance and power Top-Chefs expect from a professional-grade hood. It has highly durable professional stainless steel baffle filters, LED replaceable lamps with one setting light. HUSH Sound Suppression that reduces sound up to 35%, enabling you to cook up a storm and still comfortably entertain.



CALABRIA

ELICA DESIGN CENTER



Size	30" - 36" - 42" - 48"
Dimensions	30"W x 25"D x 18"H 36"W x 25"D x 18"H 42"W x 25"D x 18"H 48"W x 25"D x 18"H
Mounting type	Wall-Mount
Type Finish	Stainless Steel
Installation Type	Ducted Installation Only



Controls	Fully Retractable Rotating Knobs w/ Blue Backlighting
Illumination	2 Consumer Replaceable LED (30", 36"), 7.5 watts 3 Consumer Replaceable LED (42", 48"), 7.5 watts
Blower Type	600 CFM(4-speed) - 30" 1200 CFM (4-speed) - (36", 42", 48")
Noise (sones)	Min: 2.01, Max: 6.0 (30") Min: 3.1, Max: 7.7 (36", 42", 48")
Blower Performance	Speed 1, 205 CFM (30") / 375 CFM (36", 42", 48") Speed 2, 350 CFM (30") / 640 CFM (36", 42", 48") Speed 3, 510 CFM (30") / 940 CFM (36", 42", 48") Speed 4, 600 CFM (30") / 1200 CFM (36", 42", 48")
Electrical	120 V - 60 Hz 550 Wattage
Duct transition	10" Round with BackDraft Damper (Top and Rear)
Dishwasher-Safe, Professional Stainless Steel Angled Baffle Filter 2 (30", 36", 42") / 3(48")	

ACCESSORIES

Optional Chimney Extension	See on page 98
Optional SS Back Splash & Warming Racks	See on page 98
Optional heat Lamp Kit (bulb included)	See on page 98
Make Up Air KIT 10"	CODE: KIT0148978

MODELS

CALABRIA 30" SS	ECL630S4
CALABRIA 36" SS	ECL136S4
CALABRIA 42" SS	ECL142S4
CALABRIA 48" SS	ECL148S4



See page 125

CERVINIA

ELICA DESIGN CENTER



Reference image only.



CERVINIA

ELICA DESIGN CENTER

See page 125

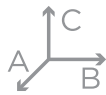

Size	30" - 36"
Dimensions	30"W x 23"D x 11 1/32"H 36"W x 23"D x 11 1/32"H
Mounting type	Under-Cabinet
Type Finish	Stainless Steel
Installation Type	Ducted Installation Only
Controls	Fully Retractable Rotating Knobs w/ Blue Backlighting
Illumination	2 Consumer Replaceable LED, 7.5 watts
Blower Type	600 CFM (4-speed)
Noise (sones)	Min: 2.34, Max: 7.0
Blower Performance	Speed 1, 170 CFM Speed 2, 280 CFM Speed 3, 440 CFM Speed 4, 600 CFM
Electrical	120 V - 60 Hz 550 Wattage
Duct transition	3 1/4" x 10" with Back Draft Damper (Top and Rear)
2 Dishwasher-Safe, 2 Professional Stainless Steel Angled Baffle Filter	
ACCESSORIES	
Optional 6-inch Chimney Extension 30 inch	KIT02159
Optional 6-inch Chimney Extension 36 inch	KIT02158
Optional 10-inch Chimney Extension 30 inch	KIT02160
Optional 10-inch Chimney Extension 36 inch	KIT02161
Optional SS Back Splash & Warming Rack 30 inch	KIT0142864
Optional SS Back Splash & Warming Rack 36 inch	KIT0142867
Make Up Air KIT 3/4" x 10"	CODE: KIT0148981
MODELS	
CERVINIA 30" SS	ECV630S3
CERVINIA 36" SS	ECV636S3



AREZZO

ELICA DESIGN CENTER

COMPACT
AND EFFICIENT

AREZZO provides professional performance, while being discreetly mounted inside the cabinetry. AREZZO is available in 28 1/2" width with a 600 CFM blower, and equipped with a 1200 CFM blower for widths of 34 1/2", 40 1/2" and 46 1/2" for extraordinary ventilating power. With new backlit hidden knob controls operate the 4 speed blower and LED lighting. Easy maintenance, higher efficiency and a cleaner kitchen area ensured by Elica's patented Baffle Slot Filters, which capture a higher percentage of contaminants and hold larger volumes of grease than traditional baffle filters. AREZZO is designed for standard ducted installation only.



AREZZO

ELICA DESIGN CENTER

Size	28" - 34" - 40" - 46"
Dimensions	28 1/2"W x 22"D x 11 1/2"H 34 1/2"W x 22"D x 11 1/2"H 40 1/2"W x 22"D x 11 1/2"H 46 1/2"W x 22"D x 11 1/2"H
Mounting type	Insert
Type Finish	Stainless Steel
Installation Type	Ducted Installation Only



Controls	Fully Retractable Rotating Knobs w/ Blue Backlighting
Illumination	2 LED, 7.5 watts (28", 34") Consumer Replaceable 4 LED, 7.5 watts (40", 46") Consumer Replaceable
Blower Type	600 CFM(4-speed) - 28" 1200 CFM(4-speed) - 34", 40" & 46"
Noise (sones)	Min: 2.0, Max: 9.6(28") Min: 2.05, Max: 7.5 (34", 40", 46")
Blower Performance	Speed 1, 90 CFM (28") / 380 CFM (34", 40", 46") Speed 2, 330 CFM (28") / 660 CFM (34", 40", 46") Speed 3, 490 CFM (28") / 950 CFM (34", 40", 46") Speed 4, 600 CFM (28") / 1200 CFM (34", 40", 46")
Electrical	120 V - 60 Hz 1000 Wattage
Duct transition	10" Round with Back Draft Damper (Top only)

Dishwasher-Safe, Professional Stainless Steel Angled Baffle Filter

MODELS

AREZZO 28" SS	EAR628S4
AREZZO 34" SS	EAR134S4
AREZZO 40" SS	EAR140S4
AREZZO 46" SS	EAR146S4

ACCESSORIES

In Line Blower Kit 8" or 10" duct size compatible	KIT0154387
External Blower Kit 1200 CFMs 8" or 10"	KIT0153054
Make Up Air KIT 10"	KIT0148978



See page 125



TRENTO

ELICA DESIGN CENTER



Reference image only.



TRENTO

ELICA DESIGN CENTER

See page 125 



Size Dimensions 34"
34 1/2"W x 18"D x 11 1/2"H



Mounting type Insert

Type Finish Stainless Steel



Installation Type Ducted Installation Only

Controls Fully Retractable Rotating Knobs w/ Blue Backlighting



Illumination 2 Consumer Replaceable LED, 7.5 watts

Blower Type 1200 CFM(4-speed)

Noise (sones) Min: 2.05, Max: 7.5

Blower Performance
Speed 1, 380 CFM
Speed 2, 660 CFM
Speed 3, 950 CFM
Speed 4, 1200 CFM



Electrical 120 V - 60 Hz 1000 Wattage

Duct transition 10" Round with BackDraft Damper (top only)



Dishwasher-Safe, Professional Stainless Steel



MODELS

TRENTO 34" SS ETR134S1



ACCESSORIES

In Line Blower Kit 8" or 10" duct size compatible KIT0154387
External Blower Kit 1200 CFMs 8" or 10" KIT0153054
Make Up Air KIT 10" KIT0148978



CAPRI

ELICA DESIGN CENTER

Tame the outdoors, without sacrificing style and luxury. Capri features a heavy gauge, corrosion resistant 302-grade stainless steel body, which will withstand the harshest environment. The extra deep 32" hood body is complimented with dual sets of angled stainless steel professional baffle filters, that provide exceptional air capture and a 1200 CFM blower has the power to do the job.

Capri is available in 36" and 48" widths, an optional 3" spacer will extend the depth to 35" for added capture efficiency, plus optional 12" and 6" duct covers are available to reach any ceiling height.





ELICA PRO

Reference image only.



CAPRI
ELICA DESIGN CENTER



SEAMLESS
LOOK



GREASE
COLLECTORS



PROFESSIONAL
PERFORMANCE



LED
REPLACEABLE



HEAT GUARD

Size 36" - 48"
Dimensions 36"W x 32"D x 18"H
48"W x 32"D x 18"H

Mounting type Wall-Mount

Type Finish Corrosion Resistant Grade Stainless Steel

Installation Type Ducted Installation Only



Controls	Fully Retractable Rotating Knobs w/ Blue Backlighting
Illumination	2 LED, 7.5 watts (36") Consumer Replaceable 4 LED, 7.5 watts(48") Consumer Replaceable
Blower Type	1200 CFM (4-speed) Internal or external
Noise (sones)	Min: 2.47, Max: 9.04
Blower Performance	Speed 1, 375 CFM Speed 2, 640 CFM Speed 3, 940 CFM Speed 4, 1200 CFM
Electrical	120 V - 60 Hz 913 Wattage
Duct transition	10" Round with Back Draft Damper (Top Only)
Dishwasher-Safe, Professional Stainless Steel (4w/36", 6w/48")	

MODELS	
CAPRI 36" SS	ECP136SS
CAPRI 48" SS	ECP148SS

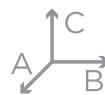

See page 125



CALABRIA

	SIZE	CODE
Optional 6-inch Chimney Extension	30 inch	KIT02159
	36 inch	KIT02158
	42 inch	KIT02622
	48 inch	KIT02164
Optional 12-inch Chimney Extension	30 inch	KIT02160
	36 inch	KIT02161
	42 inch	KIT02623
	48 inch	KIT02165
Optional Heat Lamp Kit	30 inch	KIT0155106
	36 inch	KIT0155107
	42 inch	KIT0155110
	48 inch	KIT0155111
Optional Stainless Steel Back Splash & Warming Racks	30 inch	KIT0142864
	36 inch	KIT0142867
	42 inch	KIT0142868
	48 inch	KIT0142870
Inline Blower KIT 1200 CFM, 8" or 10" Duct Size Compatible	30 inch	KIT0154387
	36 inch	
	42 inch	
	48 inch	
External Blower KIT 1200 CFM, 8" or 10" Duct Size Compatible	30 inch	KIT0153054
	36 inch	
	42 inch	
	48 inch	

ICONIC

ICONIC SERIES HOODS ARE UNIQUELY ITALIAN,
WITH A FOCUS ON DESIGN THAT MAKES
A STATEMENT IN ANY HOME, PROVIDING
CAPTIVATING BEAUTY, COMPLEMENTED BY
INNOVATIVE MATERIALS AND TECHNOLOGY
THAT PROMOTE CURIOSITY, EMOTION AND
CONVERSATION.



#STYLE #APPEAL #FANTASY #UNIQUENESS

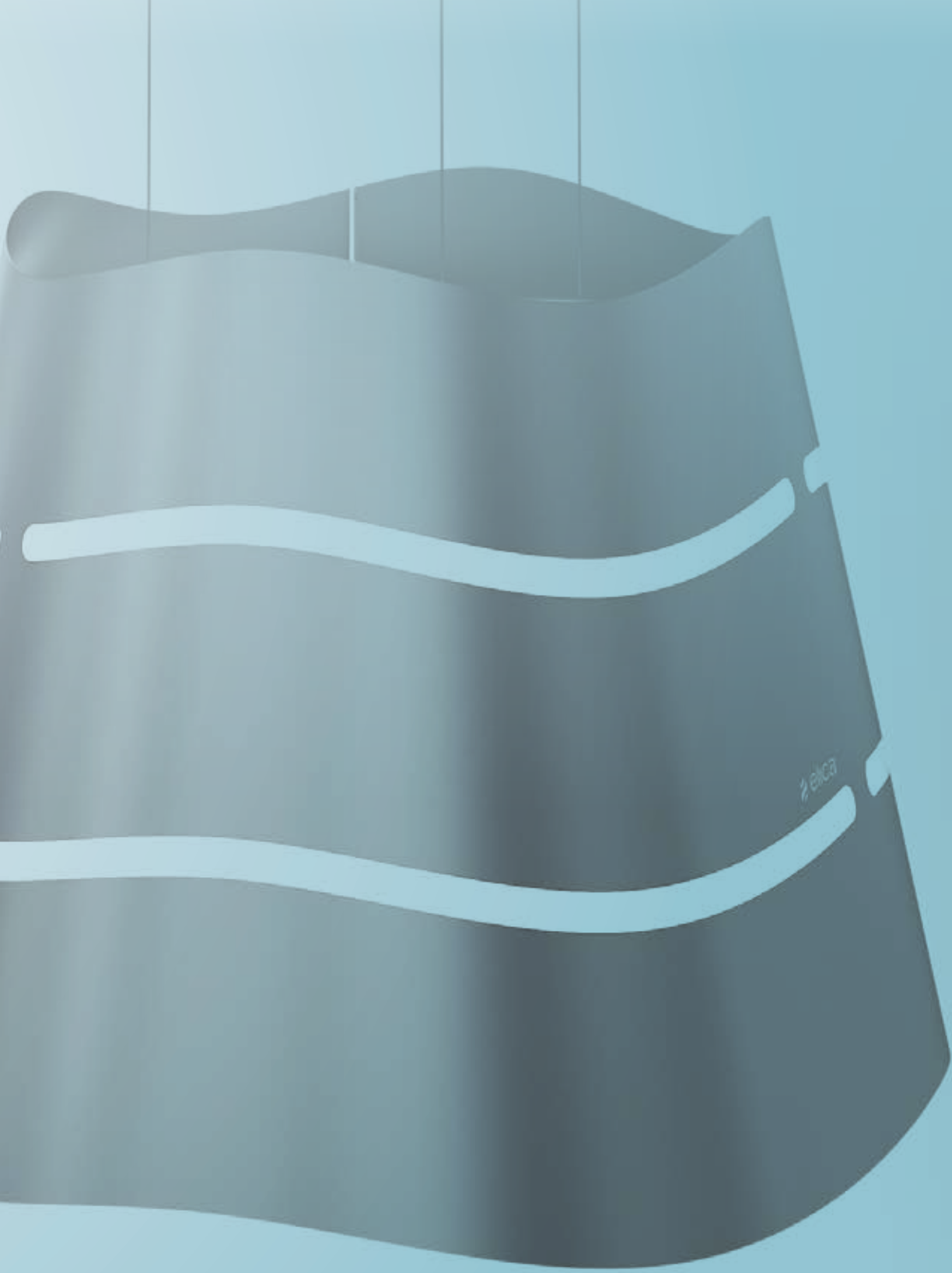

All pictures shown are for illustration purpose only. Actual product may vary due to product enhancement.

CAPTIVATING HIGH DESIGN

EASY brilliantly glossy finish reflects the world around it like a kaleidoscope, and provides a powerful visual impact, while the modern, clean-lined definition makes it easily adaptable to a variety of styles and environments. Many are stunned by EASY's pendent light appearance, touch control, LED lighting and perimeter aspiration are pleased to find its decorative qualities by a high functioning range hood hidden within.

Reference image only.



EASY

ELICA DESIGN CENTER

See page 125 



Size 20"
Dimensions 19 3/4"W x 19 3/4"D x 16 7/8"H

Mounting type Island/Wall-Mount



Type Finish Stainless Steel / White

Installation Type Recirculating Installation Only

Controls Touch Control 3 Speed + Booster



Illumination 3 LED, 5 watts

Blower Type 355 CFM (4-speed)

Noise (sones) Min: 1.65, Max: 5.0

Blower Performance
Speed 1, 102 CFM
Speed 2, 165 CFM
Speed 3, 240 CFM
Speed 4, 355 CFM



Electrical 120 V - 60 Hz 460 Wattage



1 Dishwasher-Safe, Perimeter Aspiration+ Aluminum Mesh Filter
1 Carbon Long Life Filter



ACCESSORIES

Optional Wall Mounting Bracket Kit CODE: KIT0121394

High Ceiling Extension Kit (6'10" - 23'5") CODE: KIT01921



MODELS

EASY 20" SS EES320SS

EASY 20" White EES320WT

STAR 
ELICA DESIGN CENTER



Reference image only.



STAR

ELICA DESIGN CENTER

See page 125 



Size	20"
Dimensions	18 5/16"W x 18 5/16"D x 13 1/2"H
Mounting type	Island
Type Finish	Glass Crystals + Stainless Steel
Installation Type	Recirculating Installation Only
Controls	Magic Wand
Illumination	1 Halogen 20 watts
Blower Type	300 CFM (4-speed)
Noise (sones)	Min: 0.31, Max: 4.1
Blower Performance	Speed 1, 100 CFM Speed 2, 175 CFM Speed 3, 250 CFM Speed 4, 300 CFM
Electrical	120 V - 60 Hz 320 Wattage

1 Dishwasher-Safe, Aluminum Mesh Grease Filter, Long Life Carbon Filter

ACCESSORIES

Optional High Ceiling Extension Kit (6'10" - 23'5")	CODE: KIT01921
Optional Jet Black Remote Control	CODE: KIT02183/1

MODELS

STAR 20" SS	EST319GL
-------------	----------

Reference image only.



WAVE

ELICA DESIGN CENTER

See page 125 



Size 20"
Dimensions 19 3/4"W x 19 3/4"D x 16 7/8"H

Mounting type Island/Wall-Mount

Type Finish Stainless Steel

Installation Type Recirculating Installation Only

Controls Electronic Backlit Push Button

Illumination 2 Halogen, 20 watts
3 Incandescent, 40 watts

Blower Type 350 CFM (3-speed)

Noise (sones) Min: 0.3, Max: 3.8

Blower Performance Speed 1, 110 CFM
Speed 2, 220 CFM
Speed 3, 350 CFM

Electrical 120V - 60 Hz 320 Wattage

Dishwasher-Safe, Aluminum Mesh Grease Filter, 1 Long Life Carbon Filter

ACCESSORIES

Optional High Ceiling Extension Kit (6'10" - 23'5") CODE: KIT01921

Optional Wall Mounting Bracket Kit CODE: KIT02349

MODELS

WAVE 20" SS EWW320SS



Reference image only.



TWIN

ELICA DESIGN CENTER

See page 125 



Size	36"
Dimensions	35 7/16"W x 19 11/16"D x 14 3/16"H
Mounting type	Island
Type Finish	Stainless Steel
Installation Type	Recirculating Installation Only
Controls	Magic Wand
Illumination	2 Halogen, 20 watts 6 Incandescent, 40 watts
Blower Type	550 CFM (4-speed)
Noise (sones)	Min: 0.31, Max: 4.3
Blower Performance	Speed 1, 200 CFM Speed 2, 325 CFM Speed 3, 450 CFM Speed 4, 550 CFM
Electrical	120 V - 60 Hz 320 Wattage

Dishwasher-Safe, 2 Aluminum Mesh Grease Filter, 2 Long Life Carbon Filter

ACCESSORIES

Optional High Ceiling Extension Kit (6'10" - 23'5")	CODE: KIT01921
Optional Jet Black Remote Control	CODE: KIT02183/1

MODELS	
TWIN 36" SS	ETP536SS

ICONIC



SIENA

ELICA DESIGN CENTER



TO TAKE CENTER STAGE

When the view out of your kitchen window is too spectacular to disrupt it with a large range hood, Elica's SIENA is the perfect solution. Siena literally installs into the ceiling and is discreetly flush mounted, which allows the cabinetry and outdoors to take center stage. However, when it's time to cook, Siena will easily do the job.

Siena comes equipped with a powerful 600 CFM and in-line blower, which is mounted in the attic for added silence and peacefulness. The 43" x 27" size provides excellent capture area, and in addition Perimeter Aspiration Technology has been included increasing suction by 35%, making SIENA a highly effective hood despite its out-of-sight location. SIENA's bright halogen lighting and 4 speed blower are conveniently operated by an ergonomic remote control.



Reference image only.



SIENA

ELICA DESIGN CENTER

See page 125 



≥24"



≥30"



BLOWER KIT



REMOTE CONTROL



AMBIENT LIGHT



TOP PERFORMANCE



PERIMETER ASPIRATION

Size 43"
Dimensions 43"W x 27"D x 7 3/4"H

Mounting type Ceiling

Type Finish Stainless Steel

Installation Type Ducted Installation Only

Controls Remote Control

Illumination 4 LED, 2.5 watts

Blower Type 600 CFM In Line (4-speed)

Blower Performance
Speed 1, 160 CFM
Speed 2, 280 CFM
Speed 3, 470 CFM
Speed 4, 600 CFM

Electrical 120 V - 60 Hz 365 Wattage

Duct transition 5 way, 6" Round

Dishwasher Safe Perimeter Aspiration, Aluminum Mesh Filter

ACCESSORIES

In Line Blower 600 CFMs

CODE: PRF0116568

MODELS

SIENA 43"X27' CEILING MOUNTED HOOD

ESNX43S1

Reference image only.



CHROME

ELICA DESIGN CENTER

See page 125 



Size	23"
Dimensions	22 7/8"W x 17"D x 22 7/8"H
Mounting type	Island
Type Finish	Stainless Steel
Installation Type	Ducted or Recirculating
Controls	Magic Wand
Illumination	2 LED, 3 watts
Blower Type	600 CFM (4-speed)
Noise (sones)	Min: 0.7, Max: 4.8
Blower Performance	Speed 1, 195 CFM Speed 2, 340 CFM Speed 3, 500 CFM Speed 4, 600 CFM
Electrical	120 V - 60 Hz 490 Wattage

1 EDS Dishwasher-Safe Anodized Aluminum Mesh Grease Filter

ACCESSORIES

Optional Recirculating Kit	CODE: KIT01916/S
Optional Jet Black Remote Control	CODE: KIT02183/1

MODELS

CHROME 23" STAINLESS	ECH623S1
----------------------	----------

Reference image only.



GLIDE

ELICA DESIGN CENTER

See page 125 



Size	30" - 36"
Dimensions	30"W x 11 1/2" - 19 3/4"D x 2 3/4"H 36"W x 11 1/2" - 19 3/4"D x 4 3/4"H
Mounting type	Under-Cabinet
Type Finish	Stainless Steel + Glass
Installation Type	Ducted or Recirculating
Controls	Backlit Electronic Push Button Controls
Illumination	2 LED, 3 watts
Blower Type	400 CFM (4-speed)
Noise (sones)	Min: 0.7, Max: 5.2
Blower Performance	Speed 1, 110 CFM Speed 2, 200 CFM Speed 3, 300 CFM Speed 4, 400 CFM
Electrical	120 V - 60 Hz 270 Wattage
Duct transition	6" Round (Top Only)



1 Dishwasher-Safe, Stainless Steel Mesh Filter



ACCESSORIES

Optional Recirculating Kit CODE: F00539

MODELS

GLIDE 30" STAINLESS	EGL430S1
GLIDE 36" STAINLESS	EGL436S1

ICONIC

COMFORT

THE COMFORT SERIES OF RANGE HOODS FEATURE HIGHLY POPULAR ITALIAN HOOD DESIGNS, WHICH ARE EQUIPPED WITH A CORE SET OF FEATURES THAT DELIVER FUNCTIONALITY, PERFORMANCE, ARE EASY TO INSTALL AND OVERALL DELIVER A VERY HIGH LEVEL OF VALUE TO THE CONSUMER.



#SIMPLICITY #GOOD LOOKING #HIGH QUALITY #VALUE



All pictures shown are for illustration purpose only. Actual product may vary due to product enhancement.

Reference image only.



TT
ELICA DESIGN CENTER

See page 125 



LED LIGHT



3X LAYER
MESH FILTER

Size	24"
Dimensions	23 9/16"W x 17 1/18"D x 1 9/16"H
Mounting type	Under-Cabinet
Type Finish	Stainless Steel
Installation Type	Ducted or Recirculating
Controls	Hidden Electronic Touch Controls
Illumination	2 LED, 2.1 watts
Blower Type	400 CFM (3-speed)
Noise (sones)	Min: 1.5, Max: 5.9
Blower Performance	Speed 1, 160 CFM Speed 2, 280 CFM Speed 3, 400 CFM
Electrical	120 V - 60 Hz 280 Wattage
Duct Transition	6" Round (Top Only)

2 Dishwasher-Safe, Anodized Aluminum Mesh Filter

ACCESSORIES

Optional Recirculating Kit	CODE: F00539
Optional CFM Reduction Kit	CODE: KIT02748

MODELS

TT 24" STAINLESS	ETT424S1
------------------	----------

Reference image only.



ALLASIO

ELICA DESIGN CENTER

See page 125

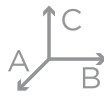

Size	30" - 36"
Dimensions	30"W x 20"D x 4 3/4"H 36"W x 20"D x 4 3/4"H
Mounting type	Under-Cabinet
Type Finish	Stainless Steel
Installation Type	Ducted or Recirculating
Controls	Backlit Electronic Push Button Controls
Illumination	2 LED, 2.1 watts
Blower Type	300 CFM (3-speed)
Noise (sones)	Min: 1.85, Max: 4.2
Blower Performance	Speed 1, 120 CFM Speed 2, 210 CFM Speed 3, 300 CFM
Electrical	120 V - 60 Hz 360 Wattage
Duct transition	3 1/4" x 10" with Back Draft Damper (Top and Rear)



2 Dishwasher-Safe, Anodized Mesh Grease Filter

ACCESSORIES

Optional Recirculating Kit 30"	CODE: KIT0217
Optional Recirculating Kit 36"	CODE: KIT0217
Optional Backdraft Damper 7" round	CODE: KIT0272

MODELS

ALLASIO 30" SS	EAL330S1
ALLASIO 36" SS	EAL336S1
ALLASIO WHITE 30"	EAL330WT
ALLASIO BLACK 30"	EAL330BL

*For Allasio black and white finishes, consider different controls and lightning

Reference image only.



NEMI

ELICA DESIGN CENTER

See page 125 



Size	30" - 36"
Dimensions	30"W x 18 3/4"D x 5"H 36"W x 18 3/4"D x 5"H
Mounting type	Under-Cabinet
Type Finish	Stainless Steel
Installation Type	Ducted or Recirculating
Controls	Backlit Electronic Push Button
Illumination	2 LED, 2.1 watts
Blower Type	280 CFM (3-speed)
Noise (sones)	Min: 1.5, Max: 4.7
Blower Performance	Speed 1, 110 CFM Speed 2, 220 CFM Speed 3, 280 CFM
Electrical	120 V - 60 Hz 210 Wattage
Duct transition	3" x 1/4" x 10" with Back Draft Damper (Top or Rear)



Dishwasher-Safe, Anodized Aluminum Mesh

ACCESSORIES

Optional Backdraft Damper 7' round	CODE: KIT02723
Optional Duct Transition	CODE: KIT0142872
Optional Recirculating Kit 30" - 36"	CODE: KIT0140997

MODELS

NEMI 30" SS	ENM230S1
NEMI 36" SS	ENM236S1
NEMI WHITE 30"	ENM230WT
NEMI BLACK 30"	ENM230BL

*For Nemi black and white finishes, consider different controls and lightning

Reference image only.



VOLTERRA

ELICA DESIGN CENTER

See page 125

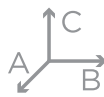

Size	24" - 30" - 36"
Dimensions	24"W x 19 5/8"D x 10 1/4"H 30"W x 19 5/8"D x 10 1/4"H 36"W x 19 5/8"D x 10 1/4"H

Mounting type	Wall-Mount
Type Finish	Stainless Steel
Installation Type	Ducted or Recirculating
Controls	Backlit Electronic Push Button
Illumination	2 LED lamps, 2,1 watts
Blower Type	400 CFM (3-speed)
Noise (sones)	Min: 0.83, Max: 6.0
Blower Performance	Speed 1, 160 CFM Speed 2, 285 CFM Speed 3, 400 CFM
Electrical	120 V - 60 Hz 300 Wattage
Duct transition	6" Round with Back Draft Damper (Top only)



Dishwasher-Safe, Anodized Aluminum Mesh (2w/24", 30" & 3w/36")
Telescopic Chimney Extension 8'5"-11'3" (ducted) / 8'6"-11'7" (recirculating)

ACCESSORIES	
Optional Recirculating Kit	CODE: KIT02766
Optional Long Chimney Extension Kit (8'5"-11'3" ducted / 8'6"-11'7" recirculating)	CODE: KIT02762
CFM Reduction Kit	CODE: KIT02748

MODELS	
VOLTERRA 24" SS	EVL424SS
VOLTERRA 30" SS	EVL430S2
VOLTERRA 36" SS	EVL436S2

Reference image only.



TOBLINO

ELICA DESIGN CENTER

See page 125 



Size	24" - 30" - 36"
Dimensions	24"W x 19 5/8"D x 1 9/16"H 30"W x 19 5/8"D x 1 9/16"H 36"W x 19 5/8"D x 1 9/16"H

Mounting type	Wall-Mount
Type Finish	Stainless Steel
Installation Type	Ducted or Recirculating
Controls	Backlit Electronic Push Button
Illumination	2 LED Lamps, 2.1 watts
Blower Type	400 CFM (3-speed)
Noise (sones)	Min: 0.78, Max: 6.0
Blower Performance	Speed 1, 160 CFM Speed 2, 280 CFM Speed 3, 400 CFM
Electrical	120 V - 60 Hz 300 Wattage
Duct transition	6" Round with Back Draft Damper (Top Only)



Dishwasher-Safe, Anodized Aluminum Mesh (2w/24", 30" & 3w/36")
Telescopic Chimney Extension 8'5" - 12'11" (ducted) / 8'9" - 12'5" (recirculating)

ACCESSORIES

Optional Recirculating Kit	CODE: KIT0102875
Optional Long Chimney Extension Kit (8'5" - 12'11" ducted / 8'9" - 12'5" recirculating)	CODE: KIT02785
CFM Reduction Kit	CODE: KIT02748

MODELS

TOBLINO 24" SS	ETB424SS
TOBLINO 30" SS	ETB430S2
TOBLINO 36" SS	ETB436S2

Reference image only.



POTENZA

ELICA DESIGN CENTER

See page 125

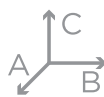

Size	30" - 36"
Dimensions	30"W x 19 5/8"D x 1 15/16"H 36"W x 19 5/8"D x 1 15/16"H
Mounting type	Wall-Mount
Type Finish	Stainless Steel
Installation Type	Ducted or Recirculating
Controls	Backlit Electronic Push Button
Illumination	2 LED, 2.1 watts
Blower Type	400 CFM (3-speed)
Noise (sones)	Min: 0.91, Max: 5.9
Blower Performance	Speed 1, 160 CFM Speed 2, 280 CFM Speed 3, 400 CFM
Electrical	120 V - 60 Hz 300 Wattage
Duct transition	6" Round with Back Draft Damper (Top Only)

Dishwasher-Safe, Anodized Aluminum Mesh Filter
Telescopic Chimney Extension 8'5" - 12'1" (ducted) / 9'2" - 12'5" (recirculating)

ACCESSORIES	
Optional Recirculating Kit	CODE: KIT02875
Optional Long Chimney Extension Kit (8'5" - 12'1" ducted / 9'2" - 12'5" recirculating)	CODE: KIT0100315
CFM Reduction Kit	CODE: KIT02748

MODELS	
POTENZA 30" SS	EPT430S2
POTENZA 36" SS	EPT436S2

Reference image only.



ASTI

ELICA DESIGN CENTER

See page 125 



Size	22" - 28"
Dimensions	22 1/4"W x 10 3/4"D x 9 1/2"H 28 1/4"W x 10 3/4"D x 9 1/2"H
Mounting type	Insert
Type Finish	Stainless Steel
Installation Type	Ducted or Recirculating
Controls	Backlit Electronic Push Button
Illumination	2 LED, 2,1 watts
Blower Type	400 CFM(3-speed)
Noise (sones)	Min: 1.5, Max: 5.9
Blower Performance	Speed 1, 160 CFM Speed 2, 280 CFM Speed 3, 400 CFM
Electrical	120 V - 60 Hz 340 Wattage
Duct transition	6" Round with BackDraft Damper (top only)



≥24"



≥30"



3X LAYER MESH FILTER



LED LIGHT

Dishwasher-Safe, Anodized Aluminum Mesh (1w/22", 2w/28")
Stainless Steel Liner Kit Available in 30" or 36" widths

ACCESSORIES

Optional Recirculating Kit	CODE: KIT02770
Optional Hood Liner 30"	CODE: KIT02773
Optional Hood Liner 36"	CODE: KIT02774
CFM Reduction Kit	CODE: KIT02748

MODELS

ASTI 22" SS	EAS422SS
ASTI 28" SS	EAS428S1

Reference image only.



SORA

ELICA DESIGN CENTER

See page 125 



Size	30" - 36"
Dimensions	30"W x 23"D x 10"H 36"W x 23"D x 10"H
Mounting type	Under-Cabinet
Type Finish	Stainless Steel
Installation Type	Ducted or Recirculating
Controls	Rocker Switch Controls
Illumination	2 LED Lamps, 2.1 watts
Blower Type	400 CFM (2-speed)
Noise (sones)	Min: 1.5, Max: 5.9
Blower Performance	Speed 1, 160 CFM Speed 2, 400 CFM
Electrical	120 V - 60 Hz 340 Wattage
Duct transition	3 1/4" x 10" with Back Draft Damper (Top or Rear)



2 Dishwasher-Safe, Stainless Steel Baffle Slot Grese Filter

ACCESSORIES

CFM Reduction Kit CODE: KIT02748

MODELS

SORA 30" SS	ESR430S1
SORA 36" SS	ESR436S1



RANGE HOOD PLUSES



WIRELESS
CONNECTIVITY

WIRELESS CONNECTIVITY

The wireless connection ensures constant communication between the induction cooktop and the cooker hood. Usage information of the cooktop (activated zones, cooking power and presence of pots) are transmitted in real time to the hood that processes them. The hood then selects automatically the optimum operating level to ensure a better quality of the air inside the kitchen. In this way it is possible to focus entirely on the food preparation. The hood turns off automatically when it is no longer necessary extracting cooking fumes, thus avoiding a waste of energy.



TOP
PERFORMANCE

TOP PERFORMANCE

Excellent performance for models equipped with this plus. High fume capturing capacity with an average aspiration range of 600 CFM's. with low noise levels, 1.2 - 1.7 sones at working speed.



PROFESSIONAL
PERFORMANCE

PROFESSIONAL PERFORMANCE

Special features and very high performances for models with aspiration capacity between 600 and 1200 CFM's, and noise level between 65 and 75 db(A) at maximum speed. The Ideal complement of PRO ranges.



PERIMETER
ASPIRATION

PERIMETER ASPIRATION

First developed by Elica, this technology literally turned the market 180 degrees and opened the door to hoods that could be mounted on the wall like picture frames. The technology draws air through a narrowed channel around a face plate, which increases suction, without increasing blower speed or energy consumption.



HUSH
SYSTEM

HUSH SYSTEM

An exclusive sound deadening technology that effectively reduces sound levels up to 35%, compared to typical range hoods.



CRS
CFM
REDUCTION

CFM REDUCTION

CFM Reduction System (CRS), is an exclusive feature to Elica hoods, which enables the user to reduce directly in the glass touch control the maximum blower CFM, to meet local code requirements.



HEAT
GUARD

HEAT GUARD

A safety feature that protects the hood and cabinetry from excessive heat, by sensing extreme temperatures (>158 degrees) and will automatically adjusts the blower speed to HIGH. Blower speed will automatically adjust back once temperatures drop to a safe level.



LONG LIFE FILTER

One-of-a-kind odour filter, capable of regenerating itself and of lasting up to 3 years, while standard filters have an average life between 3 to 6 months. To maintain these characteristics, the filter only requires simple maintenance: wash every 2 or 3 months with hot water and mild soap (also in the dishwasher at 65 degrees) and dry in the oven for 10 minutes at 100 degrees.



TUNE-WHITE

Elica is at the top also with the customization of kitchen lighting, thanks to the use of the led strip with the GK Changing feature which, during the installation phase, allows you to choose to adapt the hood light with other lighting in the kitchen, by adjusting the temperature of leds, choosing from a range that goes from yellow light (2700 K) to white light (6000 K). The kitchen, thanks to the hood, will have uniform cool lightning.



AMBIENT LIGHT

Elica studies on hood lighting leaves no stone unturned. Here we have thought about products not only able to light the cooktop, but the entire kitchen space. And so the hood is transformed: from a kitchen appliance to a true lighting element. Considering the design of Elica hoods, it is not hard to imagine how this option is quite unique, and represents one extraordinary point of strength for us.



LED LIGHT

LED lighting is undoubtedly the smartest solution in terms of energy saving. Expected life time of over 20.000 hours, represents the most remarkable advantage of LED light bulbs.



DIM-LIGHT

The Dimmer allows you to adjust the brightness of the light as you wish. With Elica, lighting is customized in a discreet, personal and practical way, in order to contribute in creating the perfect kitchen atmosphere.



LED CONSUMER REPLACEABLE BULB

High quality LED lighting usually requires a skilled technician to replace lamps. Avoid this expense with Elica's new LED lamps that enable typical homeowners to replace in seconds.



3X LAYER GREASE FILTER

Elica aluminum mesh filters are a step above competition, featuring triple layered, anodized aluminum that is woven into a highly dense mesh. The thick mesh captures more grease, anodization helps resist staining and provides durability to repeated cleanings in the dishwasher.



RANGE HOOD PLUS



SEMI BAFFLE
FILTER

STAINLESS STEEL BAFFLE SLOT FILTERS

A baffle shaped stainless steel filter with mesh backing allows air to pass but blocks grease, which drops into the high capacity baffle cavities. The design delivers large volume capacity, excellent capture efficiency at ALL blower speeds, silent operation, plus, durability that will last the life of the hood.



MICROHOLE
FILTER

STAINLESS STEEL MICROHOLE FILTERS

A multi-layered stainless steel filter that uses an offset hole pattern to effectively capture grease with high efficiency, plus offers large volume capacity at ALL blower speeds, silent operation and durability that will last the life of the hood.



BLOWER KIT

BLOWER KIT

Elica Blower KITS offers installation flexibility that will accommodate most construction requirements, plus provides options related to ventilation power and sound generation.



GREASE
COLLECTORS

PROFESSIONAL STAINLESS STEEL BAFFLE FILTERS WITH GREASE COLLECTORS

Professional grade, heavy gauge stainless steel baffle filters are the perfect choice for those with top chef dreams. Designed for high airflow cooking, the "S" shape design traps volumes of grease (for a cleaner kitchen), which is collected in trays for easy removal and cleaning.



TOUCH
CONTROL

ELECTRONIC TOUCH CONTROLS

Enjoy the modern design and convenience of multi-function electronic touch controls, which are discreetly hidden behind sleek black glass, and will illuminate a soft blue when activated.



SEAMLESS
LOOK

SEAMLESS CRAFTSMANSHIP

Elica Professional grade hoods feature heavy gauge stainless steel "Seamless" construction that delivers refined elegance and reflects the superior quality and Italian craftsmanship invested into each range hood.



REMOTE
CONTROL

REMOTE CONTROL

Elica's ADA compliant Remote Control, provides added convenience to the typical user, as well as, full function access for those with limited mobility.

Allasio

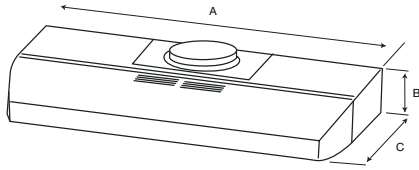

A	30" (76 cm)	36" (91.54 cm)
B	4" 1/2	
C	20"	

Arezzo - Trento

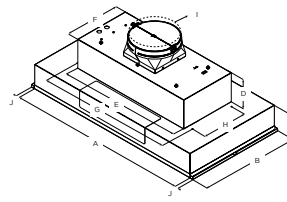

	Models				
	EAR628S3	EAR134S3	ETR134S5	EAR140S3	EAR146S3
A	28" (71 cm)	34" (86.4 cm)	40" (101.6 cm)	46" (116.8 cm)	
B	22" (55.9 cm)	18" (45.7 cm)		22" (55.9 cm)	
C		5 1/2" (13.8 cm)			
D		6" (16.4 cm)			
E		27 1/2" (70 cm)			
F		12 1/2" (31.6 cm)			
G		29 1/2" (75.7 cm)			
H		10 1/2" (25.7 cm)			
I		10" (25.4 cm)			
J		1 1/4" (1.9 cm)			

Aria

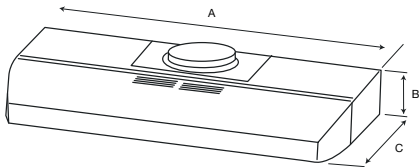

A	30" (76 cm)	36" (91.54 cm)
B	4" 1/2	
C	20"	

Asti

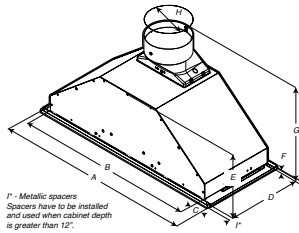

A	22 1/2" (55.9 cm)	28 1/2" (71.8 cm)
B	26" (66 cm)	
C	1 1/2" (2.9 cm)	
D	10 3/4" (27.3 cm)	
E	9 1/2" (24.2 cm)	
F	1/2" (8.5 cm)	
G	14 1/2" (37 cm)	
H	6" (15.2 cm)	
I	1/2" (1.27 cm)	

Bellagio

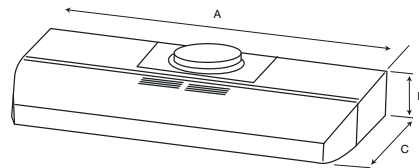

A	30" (76 cm)	36" (91.54 cm)
B	4" 1/2	
C	20"	

Calabria

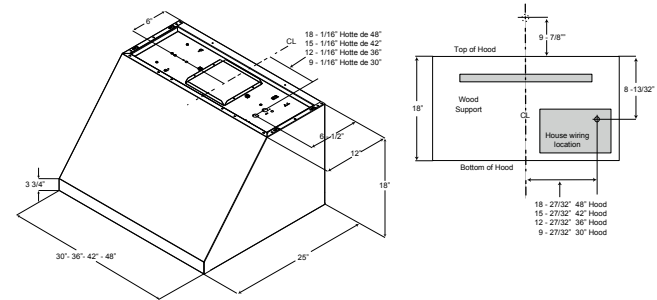

Cervinia

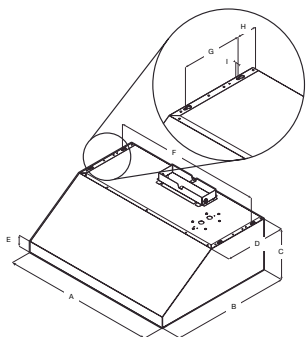

A	30" (76 cm)	36" (91.54 cm)
B	23" (58.5 cm)	
C	10" (25.3 cm)	
D	11 3/8" (30 cm)	
E	2 1/4" (5.4 cm)	
F	29 1/2" (74 cm)	35 1/2" (89.5 cm)
G	7 1/2" (19 cm)	
H	2 3/8" (6.5 cm)	
I	1 3/8" (1 cm)	

Cingoli

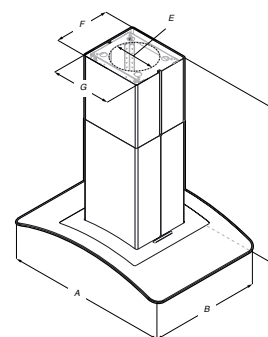

A	36" (91.4 cm)	42" (106.7 cm)
B	25 1/2" (64 cm)	
C*	Max: 49 3/8" (125.5 cm) Min: 29 3/8" (74.7 cm)	
D**	Max: 44 3/8" (112.6 cm) Min: 29 3/8" (74.7 cm)	
E	6" (15.24 cm)	
F	12" (30.5 cm)	
G	13 1/4" (33.6 cm)	

*For non-vented (recirculating installations)
**For vented installations



Como

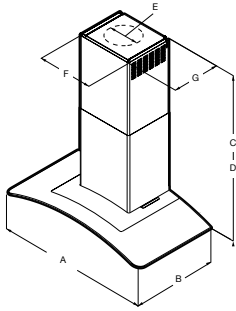

A	30" (76.2cm)	36" (91.4cm)
B	19 1/8" (50cm)	
C*	max. 36 5/8" (92cm) min. 23 3/4" (60cm)	
D**	max. 32 13/32" (82.3cm) min. 20" (50.8cm)	
E	6" (15.24cm)	
F	13 5/16" (33.5cm)	
G	10 3/4" (27.6cm)	

*For non-vented (recirculating installations)
**For vented installations

Easy

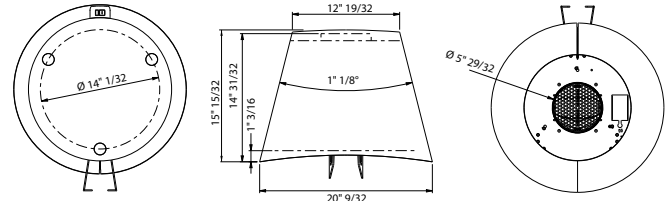

Foglia

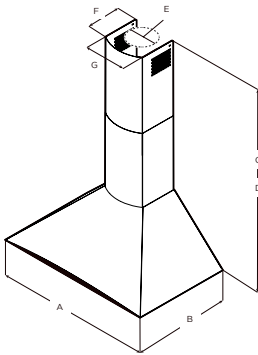

	Models	
	EFG630S1	EFG636S1
A	30" (76.2 cm)	36" (91.4 cm)
B	19 3/8" (50 cm)	
C*	Max: 42 1/8" (107 cm) Min: 28 5/8" (73 cm)	
D**	Max: 38 1/8" (97 cm) Min: 28 5/8" (73 cm)	
E	6" (15.24 cm)	
F	8" (20.5 cm)	
G	8 5/8" (21.5 cm)	

* Ductless (Recirculating) version
** Ducted version

Glide

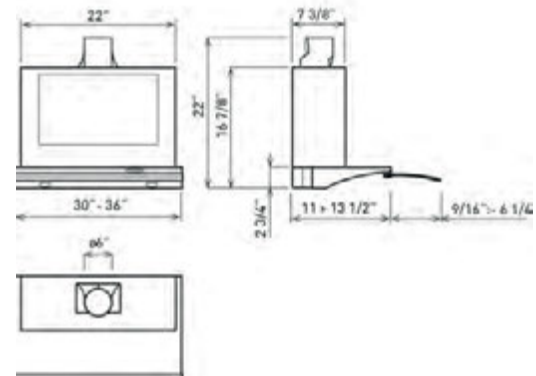

Leone

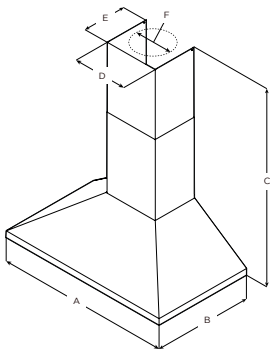

	Models			
	ELN630S1	ELN136S1	ELN142S1	ELN148SS
A	30" (76.2 cm)	36" (91.4 cm)	42" (106.7 cm)	48" (121.9 cm)
B	24" (61 cm)			
C	Max: 47 1/8" (120.9 cm) Min: 30" (76.2 cm)			
D	13 3/8" (33.2 cm)			
E	10 5/8" (27 cm)			
F	8" (20.3 cm)			

Leone Island

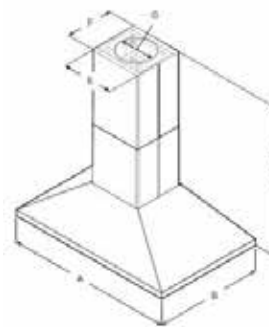

	Models	
	ELI136S1	ELI142S1
A	36" (91.4 cm)	42" (106.7 cm)
B	27" (68.6 cm)	
C	Max: 46 1/8" (118.3 cm) Min: 37 1/8" (95.3 cm)	
D*	Max: 90" (229 cm) Min: 60" (153 cm)	
E	13 1/8" (33.2 cm)	
F	12" (30.5 cm)	
G	8" (20.3 cm)	

* with Long Chimney Extension Kit

Lugano

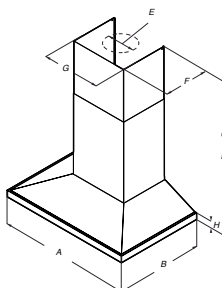

A	30" (76 cm)	36" (91.2 cm)
B	19 1/8" (60 cm)	
C*	max. 42 3/8" (108.1 cm) min. 28 1/8" (71.8 cm)	
D**	max. 38 3/8" (98.3 cm) min. 24 3/8" (62.5 cm)	
E	6" (15.24 cm)	
F	10 3/8" (26.9 cm)	
G	13 3/8" (33.2 cm)	
H	1 3/4" (4 cm)	

*For non-vented (recirculating installations)
**For vented installations

Meteorite

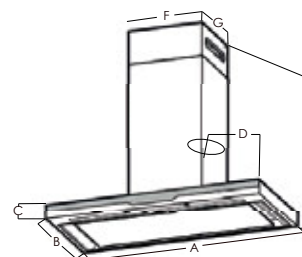

	EMT636SS
A	Min: 35 23/64" (89.8 cm) Max: 47 1/64" (119.8 cm)
B	17 1/8" (43.5 cm)
C	2 23/64" (6 cm)
D	13 3/16" (33.5 cm)
E	Min: 27 23/32" (70.4 cm) Max: 50 23/32" (129 cm)
F	12 1/64" (30.8 cm)
G	11 27/64" (33.5 cm)



Meteorite Island

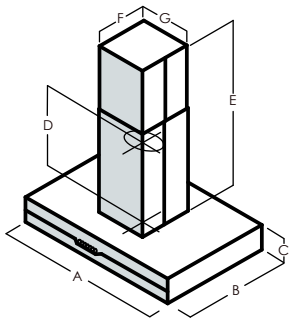

	EMI648SS
A	47 ¹¹ / ₆₄ " (119.8 cm)
B	62 ⁶³ / ₆₄ " (60 cm)
C	2 ²³ / ₆₄ " (6 cm)
D	13 ³ / ₁₆ " (33.5 cm)
E	Min: 28 ¹ / ₃₂ " (71.2 cm) Max: 37 ⁷ / ₈ " (129 cm)
F	12 ¹³ / ₆₄ " (31 cm)
G	12 ¹³ / ₆₄ " (31 cm)

Mezzano

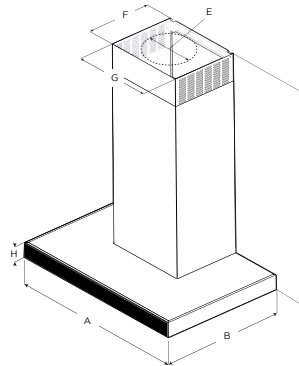

	EMZ630S3	EMZ636S3
A	30" (76.2 cm)	36" (91.4 cm)
B	19 ¹ / ₁₆ " (50 cm)	
C*	Max: 54 ¹ / ₁₆ " (139 cm) Min: 33 ¹ / ₃₂ " (86 cm)	
D**	Max: 50 ⁵ / ₁₆ " (129 cm) Min: 29 ¹ / ₁₆ " (77 cm)	
E	6" (15.24 cm)	
F	10 ³ / ₄ " (27 cm)	
G	13 ³ / ₃₂ " (33 cm)	
H	2 ⁵ / ₁₆ " (6 cm)	

* Ductless (Recirculating) version
** Ducted version

Modena

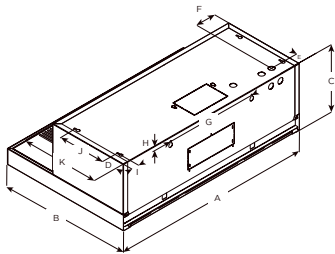

	Models	
	EMC330S3	EMC336S3
A	30" (76 cm)	36" (91.2 cm)
B	19 ¹ / ₄ " (50 cm)	
C	9 ¹ / ₂ " (25 cm)	
D	2 ¹ / ₁₆ " (5.5 cm)	
E	1 ⁹ / ₁₆ " (4 cm)	
F	3" (7.6 cm)	5" (14.6 cm)
G	13 ¹ / ₁₆ " (35 cm)	
H	5 ¹ / ₈ " (1.6 cm)	
I	1 ¹ / ₈ " (3 cm)	
J	7 ¹ / ₄ " (18.4 cm)	
K	12" (30.5 cm)	

Nemi

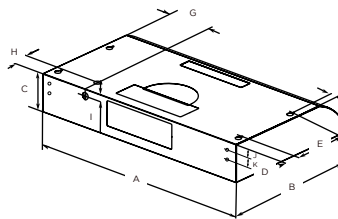

	Models	
	ENM230S1	ENM236S1
A	30" (76.2 cm)	36" (91.4 cm)
B	18 ⁵ / ₈ " (47.3 cm)	
C	4 ⁵ / ₈ " (12.5 cm)	
D	1 ¹ / ₂ " (3.8 cm)	
E	9" (22.9 cm)	
F	1" (2.5 cm)	
G	6 ⁵ / ₈ " (16.7 cm)	
H	1 ⁵ / ₁₆ " (5 cm)	
I	3 ³ / ₈ " (2.2 cm)	
J	1 ¹ / ₈ " (2.6 cm)	
K	1 ¹ / ₈ " (3.6 cm)	

Palermo

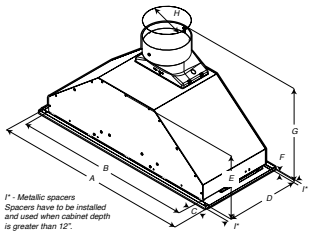

I* - Metallic spacers
Spacers have to be installed
and used when cabinet depth
is greater than 12".

A	28 ³ / ₄ " (71.8 cm)
B	26" (66 cm)
C	1 ¹ / ₄ " (2.9 cm)
D	10 ³ / ₄ " (27.3 cm)
E	9 ¹ / ₂ " (24.2 cm)
F	5 ¹ / ₈ " (8.5 cm)
G	14 ⁹ / ₁₆ " (37 cm)
H	6" (15.2 cm)
I	5 ¹ / ₂ " (1.27 cm)

Potenza

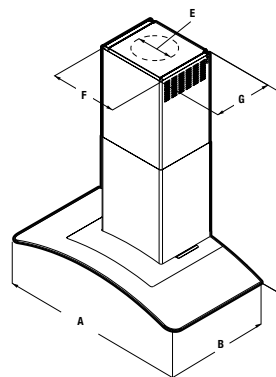

	EPT430S1	EPT436S1
A	30" (76.2cm)	36" (91.4cm)
B	19 ¹ / ₁₆ " (50cm)	
C*	max. 37 ¹ / ₁₆ " (94.4cm) min. 24 ¹ / ₁₆ " (62.6cm)	
D**	max. 33" (84cm) min. 20 ¹ / ₂ " (52.7cm)	
E	6" (15.24cm)	
F	13 ³ / ₁₆ " (33.5cm)	
G	10 ¹ / ₄ " (27.6cm)	

*For non-vented (recirculating installations)
**For vented installations

Rise

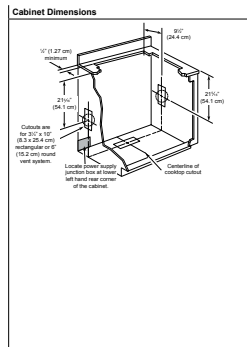
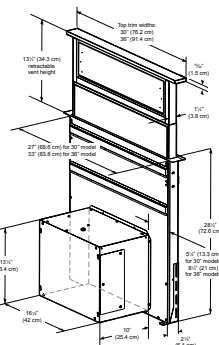

Salice

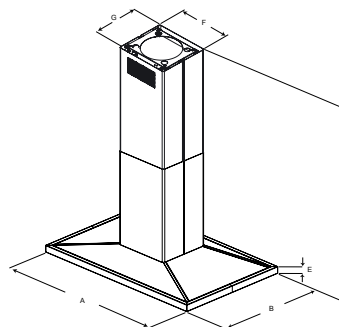

	ESL636S3	ESL642S3
A	36" (91.4cm)	42" (106.7cm)
B	27" (68.5cm)	
C*	**Min. 32 - 13/32" **Max 52 - 13/32"	
D**	**Min. 32 - 13/32" **Max 46 - 13/32"	
E	2 - 3/8"	
F	13 ¹ / ₄ " (33.5cm)	
G	12 - 1/8"	

*For non-vented (recirculating installations)
**For vented installations

Varna - Varna BBS

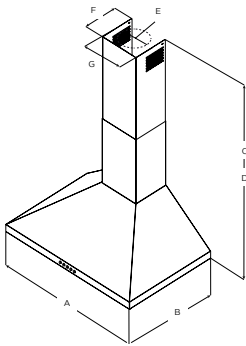

Models		
	EVR630S2 EVR630BL	EVR636S2 EVR636BL
A	30" (76.2 cm)	36" (91.4 cm)
B	19 ^{1/8} " (50 cm)	
C*	Max: 42 ^{1/2} " (107 cm) Min: 28 ^{5/8} " (72 cm)	
D**	Max: 38 ^{1/2} " (97 cm) Min: 28 ^{5/8} " (72 cm)	
E	6" (15.24 cm)	
F	7 ^{1/2} " (18.3 cm)	
G	8 ^{1/8} " (20.8 cm)	

* Ductless (Recirculating) version
** Ducted version

Vavano

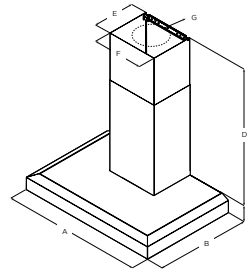

Models		
A	36" (91.4 cm)	48" (122 cm)
B	24" (61 cm)	
C	5 ^{1/2} " (12.8 cm)	
D	MAX: 52 ^{1/2} " (134 cm) MIN: 30" (76.2 cm)	
E	10 ^{1/2} " (27 cm)	
F	13 ^{1/2} " (33.2 cm)	
G	8" (20 cm)	

Vavano Island

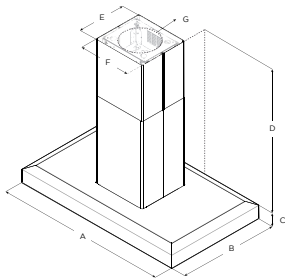

Models		
A	42" (106.7 cm)	48" (122 cm)
B	24 ^{1/2} " (62 cm)	
C	5 ^{1/2} " (12.8 cm)	
D	MAX: 51 ^{1/2} " (129.4 cm) MIN: 30" (76 cm)	
E	12" (30.5 cm)	
F	13 ^{1/2} " (33.2 cm)	
G	8" (20 cm)	

Volterra

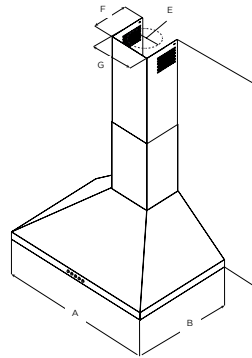

Models			
	EVL424SS	EVL430S2	EVL436S2
A	23 ^{5/8} " (60 cm)	30" (76.2 cm)	36" (91.4 cm)
B	19 ^{1/8} " (50 cm)		
C*	Max: 42 ^{1/2} " (107 cm) Min: 28 ^{5/8} " (72 cm)		
D**	Max: 38 ^{1/2} " (97 cm) Min: 28 ^{5/8} " (72 cm)		
E	6" (15.24 cm)		
F	7 ^{1/2} " (18.3 cm)		
G	8 ^{1/8} " (20.8 cm)		

* Ductless (Recirculating) version
** Ducted version



WHY THE HOOD

THE HOOD IS ESSENTIAL TO BREATHE CLEAN AIR IN THE KITCHEN.

Its main function is to improve the quality of air, by eliminating burning fumes, bad cooking odours and vapours that are harmful to both people, furniture and walls.

The hood is a valuable ally for your wellbeing. This is why, when choosing one, you need to make sure that it provides:

- Suction performance suitable for your needs and environment, in order to obtain proper air flow and lower electricity consumption.
- Effective light source to facilitate food preparation.
- Design that suits your taste and needs.
- Good usability and low noise level.

HOW TO CHOOSE IT

CHOOSE A HOOD THAT FACILITATES YOUR WORK IN THE KITCHEN, AFFORDS FREEDOM OF MOVEMENT AND SIMPLIFIES FOOD PREPARATION.

The hood should also have the right suction power. Consider the size of your kitchen and your cooking habits: this is the only way to obtain the right air flow and lower electricity consumption.

A simple calculation allows understanding the most suitable capacity for every kitchen. Just multiply the volume of the room by 10 to obtain the ideal capacity.

Choose your hood carefully and bring new air into your kitchen

THERE IS A WIDE RANGE OF INSTALLATION OPTIONS. FIND THE MODEL THAT BEST SUITS YOUR ROOM, LIFESTYLE AND WAY OF BEING.

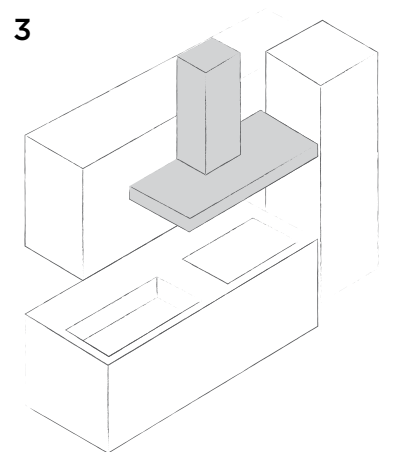
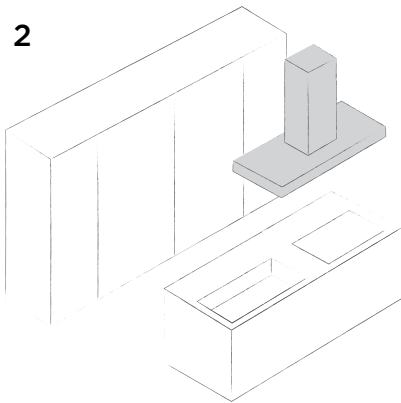
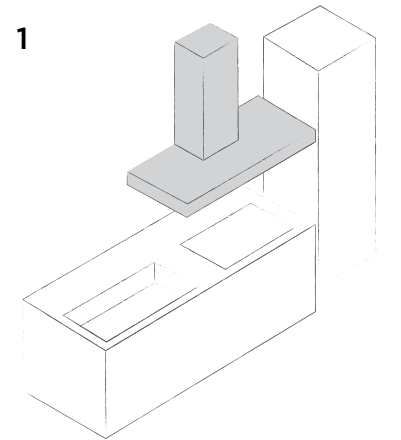

- 1 Wall-mounted**
The kitchen unit is located against the wall with the cooktop adjacent to the wall. Hood to be mounted on the wall.
- 2 Island**
The kitchen unit is located at the center of the room with the cooktop away from the wall. Hood to be mounted on the ceiling.
- 3 Built-in**
The cooktop is located under a wall unit. Hood to be installed inside the wall unit.

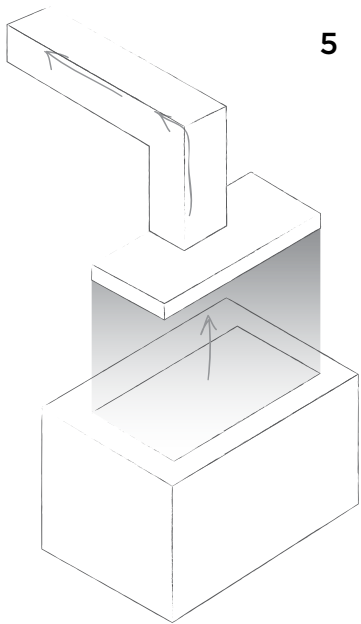

5

HOW TO INSTALL IT

THE CORRECT OPERATION OF YOUR HOOD IS ONLY ENSURED IF IT IS INSTALLED BY SPECIALIZED TECHNICIANS. ASSEMBLY AND MAINTENANCE VARY ACCORDING TO THE TWO TYPES OF HOOD: DUCT-OUT AND RECIRCULATING.

Many elica models can operate in both versions. When installing your hood, bear in mind these simple basic rules:

- Follow all the steps shown in the instruction manual of the product;
- Connect the duct-out hood to the outside with a dedicated pipe: minimized length and absence of bends ensure better performance.
- Comply with the minimum distance from the cooktop specified in the manual, in order to avoid damaging working parts and ensuring people's safety;
- Make sure that the outlet che is close to the product for connection.
- In the event of difficulties, seek assistance from a reliable

specialized technician;

Assembly varies according to the type of hood, duct- out or recirculating

5 DUCT-OUT HOOD

The duct-out hood exhausts air to the outside. This is the most used type, because it ensures high performance, high capacity and low noise level.

6 RECIRCULATING HOOD

The recirculating hood removes bad odors by means of a dedicated charcoal filter and reintroduces air into the kitchen. This type is suitable for rooms with no extractor duct, affords air saving and avoids thermal losses to the outside.

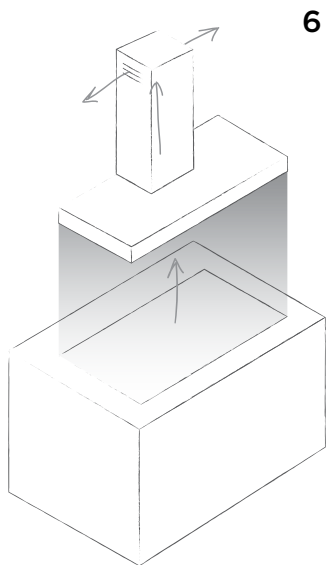

6

TAKING CARE OF IT

TO ENSURE THE LONG LIFE AND CORRECT OPERATION OF YOUR HOOD IN BOTH DUCT-OUT AND RECIRCULATING VERSIONS, THE FIRST STEP IS TO KEEP THE FILTERING SYSTEM IN GOOD CONDITION.

There are two types of filters:

- The grease filter protects your hood by trapping particles of grease. The aluminum or stainless steel grease filter requires periodic cleaning by hand with neutral detergent or in the dishwasher at low temperature (*). The paper grease filter must be replaced every month depending





on use.

- The active charcoal filter installed on recirculating hoods, traps odor particles of air. Remember to replace it every 3-4 months. Long life filters have a longer life: they must be replaced every two years.



Simple precautions will help you keep your hood in perfect condition.



(*). Always follow the instructions for washing the filter on the manual of the product.

SPECS

				
Model Name	Asti	Palermo	Trento	Arezzo
Model Numbers	EAS422SS EAS428S1	EPR628S1	ETR134S1	EAR628S4 EAR134S4 EAR140S4 EAR146S4
Dimensions	22 1/4"W x 10 3/4"D x 9 1/2"H 28 1/4"W x 10 3/4"D x 9 1/2"H	28 1/4"W x 10 3/4"D x 9 1/4"H	34 1/2"W x 18"D x 11 1/2"H	28 1/2"W x 22"D x 11 1/2"H 34 1/2"W x 22"D x 11 1/2"H 40 1/2"W x 22"D x 11 1/2"H 46 1/2"W x 22"D x 11 1/2"H
Blower Type	400 CFM(3-speed)	600 CFM(3-speed)	1200 CFM(4-speed)	600 CFM(4-speed) - 28" 1200 CFM(4-speed) - 34", 40" & 46"
Blower Performance	Speed 1, 160 CFM Speed 2, 280 CFM Speed 3, 400 CFM	Speed 1, 190 CFM Speed 2, 350 CFM Speed 3, 600 CFM	Speed 1, 380 CFM Speed 2, 660 CFM Speed 3, 950 CFM Speed 4, 1200 CFM	(28") - Speed 1, 90 CFM Speed 2, 330 CFM Speed 3, 490 CFM Speed 4, 600CFM (34", 40", 46") - Speed 1, 380 CFM Speed 2, 660 CFM Speed 3, 950 CFM Speed 4, 1200 CFM
CFM Reduction	Yes / KITO2748	No	No	No
Noise (sones)	Min: 1.5, Max: 5.9	Min: 2.1, Max: 6.0	Min: 2.05, Max: 7.5	Min: 2.0, Max: 9.6(28") Min: 2.05, Max: 7.5 (34", 40", 46")
Finish	Stainless Steel	Stainless Steel	Stainless Steel	Stainless Steel
Controls	Backlit Electronic Push Button	Stainless Steel Push Button	Fully Retractable Rotating Knobs w/ Blue Backlighting	Fully Retractable Rotating Knobs w/ Blue Backlighting
Illumination	2 LED, 2,1 watts	2 Premium LED, 2,5 watts	2 Consumer Replaceable LED, 7,5 watts	2 LED, 7,5 watts (28", 34") 4 LED, 7,5 watts (40", 46") * Consumer Replaceable
Filter Type	Dishwasher-Safe, Anodized Aluminum Mesh (1w/22", 2w/28")	2 Dishwasher-Safe, Stainless Steel Baffle Slot Grease Filter	Dishwasher-Safe, Professional Stainless Steel	Dishwasher-Safe, Professional Stainless Steel Angled Baffle Filter
Duct Transition	6" Round with BackDraft Damper (top only)	6" Round with BackDraft Damper (top only)	10" Round with BackDraft Damper (top only)	10" Round with Back Draft Damper (Top only)
Installation Type	Ducted or Recirculating	Ducted or Recirculating	Ducted Installation Only	Duc
Electrical	120 V - 60 Hz 340 Wattage	120 V - 60 Hz 260 Wattage	120 V - 60 Hz 1000 Wattage	120 V - 60 Hz 1000 Wattage
Stainless Steel Liner Kit	Available in 30" or 36" widths	Available in 30" or 36" widths		
Optional Blower	No	No	1200 CFM Inline or 1200 CFM External	1200 CFM Inline or 1200 CFM External





				
Model Name	Nemi	TT	Allasio	Bellagio
Model Numbers	ENM230S1 ENM236S1 ENM230WT ENM230BL	ETT424SS	EAL330S1 EAL336S1 EAL330WT EAL330BL	EBL430SS EBL436SS EBL430WT
Dimensions	30"W x 18 3/4"D x 5"H 36"W x 18 3/4"D x 5"H	23 9/16"W x 17 1/8"D x 1 9/16"H	30"W x 20"D x 4 3/4"H 36"W x 20"D x 4 3/4"H	30"W x 20"D x 4 3/4"H 36"W x 20"D x 4 3/4"H 30"W x 20"D x 4 3/4"H
Blower Type	280 CFM(3-speed)	400 CFM(3-speed)	300 CFM(3-speed)	430 CFM(4-speed)
Blower Performance	Speed 1, 110 CFM Speed 2, 220 CFM Speed 3, 280 CFM	Speed 1, 160 CFM Speed 2, 280 CFM Speed 3, 400 CFM	Speed 1, 120 CFM Speed 2, 210 CFM Speed 3, 300 CFM	Speed 1, 160 CFM Speed 2, 240 CFM Speed 3, 310 CFM Speed 4, 430 CFM
CFM Reduction	No	Yes/ KIT02748	No	Yes
Noise (sones)	Min: 1.5, Max: 4.7	Min: 1.5, Max: 5.9	Min: 1.85, Max: 4.2	Min: 1.4, Max: 7.1
Finish	Stainless Steel	Stainless Steel	Stainless Steel	Stainless Steel
Controls	Backlit Electronic Push Button	Hidden Electronic Touch Controls	Backlit Electronic Push Button Controls	Multi-function Electronic with LCD Display
Illumination	2 LED, 2.1 watts	2 LED, 2.1 watts	2 LED, 2.1 watts	2 Halogen, 50 watts
Filter Type	Dishwasher-Safe, Anodized Aluminum Mesh	2 Dishwasher-Safe, Anodized Aluminum Mesh Filter	2 Dishwasher-Safe, Anodized Mesh Grease Filter	2 Dishwasher-Safe, Anodized Aluminum Mesh Grease Filter
Duct Transition	3" x 1/4" x 10" with Back Draft Damper (Top or Rear)	6" Round (Top Only)	3 1/4" x 10" with Back Draft Damper (Top and Rear)	3 1/4" x 10" with Back Draft Damper (Top or Rear)
Installation Type	Ducted or Recirculating	Ducted or Recirculating	Ducted or Recirculating	Ducted or Recirculating
Electrical	120 V - 60 Hz 210 Wattage	120 V - 60 Hz 280 Wattage	120 V - 60 Hz 360 Wattage	120 V - 60 Hz 445 Wattage





			
Model Name	Aria	Modena	Glide
Model Numbers	EAI430SS EAI436SS	EMD530S3 EMD536S3	EGL430S1 EGL436S1
Dimensions	30"W x 20"D x 4 3/4"H 36"W x 20"D x 4 3/4"H	30"W x 20"D x 9"H 36"W x 20"D x 9"H	30"W x 11 1/2" - 19 3/4"D x 2 3/4"H 36"W x 11 1/2" - 19 3/4"D x 4 3/4"H
Blower Type	430 CFM(4-speed)	520 CFM(4-speed)	450 CFM(4-speed)
Blower Performance	Speed 1, 160 CFM Speed 2, 240 CFM Speed 3, 310 CFM Speed 4, 430 CFM	Speed 1, 170 CFM Speed 2, 280 CFM Speed 3, 430 CFM Speed 4, 520 CFM	Speed 1, 110 CFM Speed 2, 200 CFM Speed 3, 300 CFM Speed 4, 400 CFM
CFM Reduction	Yes	Yes	No
Noise (sones)	Min: 1.1, Max: 4.7	Min: 1.73, Max: 6.0	Min: 0.7, Max: 5.2
Finish	Stainless Steel + Black Glass	Stainless Steel + Black Glass	Stainless Steel + Glass
Controls	Touch Control 3 Speed + Booster	Touch Controls 3 Speed + Booster	Backlit Electronic Push Button Controls
Illumination	2 Premium LED Dimmable Lights, 2.5 watts	2 Premium LED Dimmable Lights, 2.5 watts	2 LED, 3 watts
Filter Type	2 Dishwasher-Safe, Stainless Steel Baffle Slot Filter	Dishwasher-Safe, Stainless Steel Microhole Grease Filter	1 Dishwasher-Safe, Stainless Steel Mesh Filter
Duct Transition	3 1/4" x 10" with Back Draft Damper (Top or Rear)	3 1/4" x 10" with Back Draft Damper (Top or Rear)	6" Round (Top Only)
Installation Type	Ducted or Recirculating	Ducted or Recirculating	Ducted or Recirculating
Electrical	120 V - 60 Hz 445 Wattage	120 V - 60 Hz 550 Wattage	120 V - 60 Hz 270 Wattage





			
Model Name	Sora	Cervinia	Calabria
Model Numbers	ESR430S1 ESR436S1	ECV630S3 ECV636S3	ECL630S4 ECL136S4 ECL142S4 ECL148S4
Dimensions	30"W x 23"D x 10"H 36"W x 23"D x 10"H	30"W x 23"D x 11 1/32"H 36"W x 23"D x 11 1/32"H	30"W x 25"D x 18"H 36"W x 25"D x 18"H 42"W x 25"D x 18"H 48"W x 25"D x 18"H
Blower Type	400 CFM(2-speed)	600 CFM(4-speed)	600 CFM(4-speed) - 30" 1200 CFM (4-speed) - (36", 42", 48")
Blower Performance	Speed 1, 160 CFM Speed 2, 400 CFM	Speed 1, 170 CFM Speed 2, 280 CFM Speed 3, 440 CFM Speed 4, 600 CFM	(30") - Speed 1, 205 CFM Speed 2, 350 CFM Speed 3, 510 CFM Speed 4, 600 CFM (36", 42", 48") - Speed 1, 375 CFM Speed 2, 640 CFM Speed 3, 940 CFM Speed 4, 1200 CFM
CFM Reduction	Yes / KIT02748	No	No
Noise (sones)	Min: 1.5, Max: 5.9	Min: 2.34, Max: 7.0	Min: 2.01, Max: 6.0 (30") Min: 3.1, Max: 7.7 (36", 42", 48")
Finish	Stainless Steel	Stainless Steel	Stainless Steel
Controls	Rocker Switch Controls	Fully Retractable Rotating Knobs w/ Blue Backlighting	Fully Retractable Rotating Knobs w/ Blue Backlighting
Illumination	2 LED Lamps, 2.1 watts	2 Consumer Replaceable LED, 7.5 watts	2 Consumer Replaceable LED, 7.5 watts
Filter Type	2 Dishwasher-Safe, Stainless Steel Baffle Slot Grease Filter	2 Dishwasher-Safe, 2 Professional Stainless Steel Angled Baffle Filter	Dishwasher-Safe, Professional Stainless Steel Angled Baffle Filter 2 (30", 36", 42") / 3(48")
Duct Transition	3 1/4" x 10" with Back Draft Damper (Top or Rear)	3 1/4" x 10" with Back Draft Damper (Top and Rear)	10" Round with BackDraft Damper (Top and Rear)
Installation Type	Ducted or Recirculating	Ducted Installation Only	Ducted Installation Only
Electrical	120 V - 60 Hz 340 Wattage	120 V - 60 Hz 550 Wattage	120 V - 60 Hz 550 Wattage





SPECS



Chimney Hoods



				
Model Name	Volterra	Varna	Varna Black	Pilato
Model Numbers	EVL424SS EVL430SS EVL436SS	EVR630S2 EVR636S2	EVR630BL EVR636BL	EPL630S1 EPL636S1
Dimensions	24"W x 19 5/8"D x 10 1/4"H 30"W x 19 5/8"D x 10 1/4"H 36"W x 19 5/8"D x 10 1/4"H	30"W x 19 11/16"D x 10 1/4"H 36"W x 19 11/16"D x 10 1/4"H	30"W x 19 11/16"D x 10 1/4"H 36"W x 19 11/16"D x 10 1/4"H	30"W x 21 1/2"D x 10 1/4"H 36"W x 21 1/2"D x 10 1/4"H
Blower Type	400 CFM(3-speed)	600 CFM(4-speed)	600 CFM(4-speed)	600 CFM(4-speed)
Blower Performance	Speed 1, 160 CFM Speed 2, 285 CFM Speed 3, 400 CFM	Speed 1, 160 CFM Speed 2, 280 CFM Speed 3, 475 CFM Speed 4, 600 CFM	Speed 1, 160 CFM Speed 2, 280 CFM Speed 3, 475 CFM Speed 4, 600 CFM	Speed 1, 160 CFM Speed 2, 280 CFM Speed 3, 475 CFM Speed 4, 600 CFM
CFM Reduction	Yes/ KIT02748	Yes	Yes	No
Noise (sones)	Min: 0.83, Max: 6.0	Min: 1.93, Max: 6.0	Min: 1.93, Max: 6.0	Min: 1.7, Max: 8.2
Finish	Stainless Steel	Stainless Steel + Black Glass	Black Stainless Steel + Black Glass	Stainless Steel
Controls	Backlit Electronic Push Button	Touch Controls 3 Speed + Booster	Touch Controls 3 Speed + Booster	Multi-function Electronic with LCD Display
Illumination	2 LED lamps, 2,1 watts	2 Premium Dimmable Lights, 2.5 watts	2 Premium LED Dimmable Lights, 2.5 watts	2 Halogen Lamps, 40 watts
Filter Type	Dishwasher-Safe, Anodized Aluminum Mesh (2w/24", 30" & 3w/36")	Dishwasher-Safe, Anodized Aluminum Mesh (2w/30" & 3w/36")	Dishwasher-Safe, Anodized Aluminum Mesh (2w/30" & 3w/36")	Dishwasher-Safe, Anodized Aluminum Mesh (2w/30" & 3w/36")
Duct Transition	6" Round with Back Draft Damper (Top only)	6" Round with Back Draft Damper (Top Only)	6" Round with Back Draft Damper (Top Only)	6" Round with Back Draft Damper (Top Only)
Installation Type	Ducted or Recirculating	Ducted or Recirculating	Ducted or Recirculating	Ducted or Recirculating
Electrical	120 V - 60 Hz 300 Wattage	120 V - 60 Hz 340 Wattage	120 V - 60 Hz 490 Wattage	120 V - 60 Hz 530 Wattage

				
Model Name	Foglia	Lugano	Stoney	Leone
Model Numbers	EFG630S1 EFG636S1	ELG630S3 ELG636S3	EST630SS EST636SS	ELN630S2 ELN136S2 ELN142S2 ELN148SS
Dimensions	30"W x 20"D x 10"H 36"W x 20"D x 10"H	30"W x 19 11/16"D x 5"H 36"W x 19 11/16"D x 5"H	30"W x 19 7/8"D x 5"H 36"W x 19 7/8"D x 5"H	30"W x 24"D x 12 1/8"H 36"W x 24"D x 12 1/8"H 42"W x 24"D x 12 1/8"H 48"W x 24"D x 12 1/8"H
Blower Type	600 CFM(4-speed)	600 CFM(4-speed)	600 CFM(4-speed)	600 CFM(4-speed) - (30") 1200 CFM (4-speed) - (36",42",48") *1200 CFM Inline and External blowers available
Blower Performance	Speed 1, 210 CFM Speed 2, 300 CFM Speed 3, 470 CFM Speed 4, 600 CFM	Speed 1, 160 CFM Speed 2, 280 CFM Speed 3, 470 CFM Speed 4, 600 CFM	Speed 1, 160 CFM Speed 2, 280 CFM Speed 3, 470 CFM Speed 4, 600 CFM	(30") - Speed 1, 205 CFM Speed 2, 350 CFM Speed 3, 510 CFM Speed 4, 600 CFM (36", 42", 48") - Speed 1, 375 CFM Speed 2, 640 CFM Speed 3, 940 CFM Speed 4, 1200 CFM
CFM Reduction	Yes	Yes	Yes	No
Noise (sones)	Min: 1.71, Max: 7.5	Min: 2.03, Max: 8.0	Min: 1.53, Max: 6.0	Min: 2.01, Max: 6.0 (30") Min: 3.21, Max: 7.7 (36",42",48")
Finish	Stainless Steel + Black Glass	Stainless Steel + Black Glass	Black Stainless Steel + Black Glass	Stainless Steel
Controls	Touch Controls 3 Speed + Booster	Touch Controls 3 Speed + Booster	Touch Controls 3 Speed + Booster (Sensor)	Fully Retractable Rotating Knobs w/ Blue Backlighting
Illumination	2 Premium LED Dimmable Lights, 2.5 watts	2 Premium LED Dimmable Lights, 2.5 watts	2 Premium LED Dimmable Lights, 2.5 watts	2 Consumer Replaceable LED, 7.5 watts
Filter Type	Dishwasher-Safe, Stainless Steel Micro Hole Grease Filter	Aluminum Mesh Filter + Perimeter Aspiration	Dishwasher-Safe, Aluminum Grease Filter-Perimeter Aspiration	Dishwasher-Safe, Professional Stainless Steel Angled Baffle Filters 1w/30", 2w/36" & 42", 3w/48"
Duct Transition	6" Round with Back Draft Damper (Top Only)	6" Round with Back Draft Damper (Top Only)	6" Round with Back Draft Damper (Top Only)	8" Round with Back Draft Damper (Top Only)
Installation Type	Ducted or Recirculating	Ducted or Recirculating	Ducted or Recirculating	Ducted Installation Only
Electrical	120 V - 60 Hz 490 Wattage	120 V - 60 Hz 530 Wattage	120 V - 60 Hz 530 Wattage	120 V - 60 Hz 800 Wattage



				
Model Name	Toblino	Mezzano	Meteorite	Vavano
Model Numbers	ETB424SS ETB430S2 ETB436S2	EMZ630S3 EMZ636S3	EMT636SS	EVV636S1 EVV648S1
Dimensions	24"W x 19 5/8"D x 19/16"H 30"W x 19 5/8"D x 19/16"H 36"W x 19 5/8"D x 19/16"H	30"W x 19 11/16"D x 19/16"H 36"W x 19 11/16"D x 19/16"H	36"W x 17 1/8"D x 2 3/8"H	36"W x 24"D x 5"H 48"W x 24"D x 5"H
Blower Type	400 CFM(3-speed)	600 CFM(4-speed)	550 CFM(4-speed)	600 CFM(4-speed) (1200 CFM Inline and External blowers available)
Blower Performance	Speed 1, 160 CFM Speed 2, 280 CFM Speed 3, 400 CFM	Speed 1, 160 CFM Speed 2, 280 CFM Speed 3, 470 CFM Speed 4, 600 CFM	Speed 1, 192 CFM Speed 2, 310 CFM Speed 3, 450 CFM Speed 4, 550 CFM	Speed 1, 205 CFM Speed 2, 350 CFM Speed 3, 510 CFM Speed 4, 600 CFM
CFM Reduction	Yes/ KIT02748	Yes	No	No
Noise (sones)	Min: 0.78, Max: 6.0	Min: 1.73, Max: 6.0	Min: 1.7, Max: 7.0	Min: 3.21, Max: 7.7
Finish	Stainless Steel	Stainless Steel + Black Glass	Stainless Steel + Black Glass	Stainless Steel
Controls	Backlit Electronic Push Button	Touch Controls 3 Speed + Booster	Touch Controls 3 Speed + Booster (Sensor)	Fully Retractable Rotating Knobs w/ Blue Backlighting
Illumination	2 LED Lamps, 2.1 watts	2 Premium LED Dimmable Lights, 2.5 watts	Strip LED 7 Watts 2700 - 6000K - Tunable White	2 Consumer Replaceable LED, 7.5 watts
Filter Type	Dishwasher-Safe, Anodized Aluminum Mesh (2w/24", 30" & 3w/36")	Dishwasher-Safe, Stainless Steel Microhole Grease Filter	Dishwasher-Safe, Aluminum Grease Filter, Perimeter Aspiration	Dishwasher-Safe, Professional Stainless Steel Angled Baffle Filters 2w/36", 3w/48"
Duct Transition	6" Round with Back Draft Damper (Top Only)	6" Round with Back Draft Damper (Top Only)	6" Round with Back Draft Damper (Top Round 6")	8" Round with Back Draft Damper (Top Only)
Installation Type	Ducted or Recirculating	Ducted or Recirculating	Ducted Installation Only	Ducted Installation Only
Electrical	120 V - 60 Hz 300 Wattage	120 V - 60 Hz 490 Wattage	120 V - 60 Hz 530 Wattage	120 V - 60 Hz 480 Wattage



				
Model Name	Toblino	Mezzano	Meteorite	Vavano
Model Numbers	ETB424SS ETB430S2 ETB436S2	EMZ630S3 EMZ636S3	EMT636SS	EVV636S1 EVV648S1
Dimensions	24"W x 19 5/8"D x 19/16"H 30"W x 19 5/8"D x 19/16"H 36"W x 19 5/8"D x 19/16"H	30"W x 19 11/16"D x 19/16"H 36"W x 19 11/16"D x 19/16"H	36"W x 17 1/8"D x 2 3/8"H	36"W x 24"D x 5"H 48"W x 24"D x 5"H
Blower Type	400 CFM(3-speed)	600 CFM(4-speed)	550 CFM(4-speed)	600 CFM(4-speed) (1200 CFM Inline and External blowers available)
Blower Performance	Speed 1, 160 CFM Speed 2, 280 CFM Speed 3, 400 CFM	Speed 1, 160 CFM Speed 2, 280 CFM Speed 3, 470 CFM Speed 4, 600 CFM	Speed 1, 192 CFM Speed 2, 310 CFM Speed 3, 450 CFM Speed 4, 550 CFM	Speed 1, 205 CFM Speed 2, 350 CFM Speed 3, 510 CFM Speed 4, 600 CFM
CFM Reduction	Yes/ KIT02748	Yes	No	No
Noise (sones)	Min: 0.78, Max: 6.0	Min: 1.73, Max: 6.0	Min: 1.7, Max: 7.0	Min: 3.21, Max: 7.7
Finish	Stainless Steel	Stainless Steel + Black Glass	Stainless Steel + Black Glass	Stainless Steel
Controls	Backlit Electronic Push Button	Touch Controls 3 Speed + Booster	Touch Controls 3 Speed + Booster (Sensor)	Fully Retractable Rotating Knobs w/ Blue Backlighting
Illumination	2 LED Lamps, 2.1 watts	2 Premium LED Dimmable Lights, 2.5 watts	Strip LED 7 Watts 2700 - 6000K - Tunable White	2 Consumer Replaceable LED, 7.5 watts
Filter Type	Dishwasher-Safe, Anodized Aluminum Mesh (2w/24", 30" & 3w/36")	Dishwasher-Safe, Stainless Steel Microhole Grease Filter	Dishwasher-Safe, Aluminum Grease Filter, Perimeter Aspiration	Dishwasher-Safe, Professional Stainless Steel Angled Baffle Filters 2w/36", 3w/48"
Duct Transition	6" Round with Back Draft Damper (Top Only)	6" Round with Back Draft Damper (Top Only)	6" Round with Back Draft Damper (Top Round 6")	8" Round with Back Draft Damper (Top Only)
Installation Type	Ducted or Recirculating	Ducted or Recirculating	Ducted Installation Only	Ducted Installation Only
Electrical	120 V - 60 Hz 300 Wattage	120 V - 60 Hz 490 Wattage	120 V - 60 Hz 530 Wattage	120 V - 60 Hz 480 Wattage





			
Model Name	Salice	Stoney Island	Leone Island
Model Numbers	ESL636S3 ESL642S3	ESI636SS ESI642SS	ELI136S2 ELI142S2
Dimensions	36"W x 27"D x 5"H 42"W x 27"D x 5"H	36"W x 27"D x 5"H 42"W x 27"D x 5"H	36"W x 27"D x 12 3/4"H 42"W x 27"D x 12 3/4"H
Blower Type	600 CFM(4-speed)	600 CFM(4-speed)	1200 CFM(4-speed) (1200 CFM Inline and External blowers available)
Blower Performance	Speed 1, 160 CFM Speed 2, 280 CFM Speed 3, 470 CFM Speed 4, 600 CFM	Speed 1, 180 CFM Speed 2, 300 CFM Speed 3, 470 CFM Speed 4, 600 CFM	Speed 1, 375 CFM Speed 2, 640 CFM Speed 3, 940 CFM Speed 4, 1200 CFM
CFM Reduction	Yes	Yes	No
Noise (sones)	Min: 1.73, Max: 6.0	Min: 1.46, Max: 6.0	Min: 3.21, Max: 7.7
Finish	Stainless Steel + Black Glass	Stainless Steel + Black Glass	Stainless Steel
Controls	Touch Controls 3 Speed + Booster	Touch Controls 3 Speed + Booster (Sensor)	Fully Retractable Rotating Knobs w/ Blue Backlighting
Illumination	4 Premium LED Dimmable Lights, 2.5 watts	4 Premium LED Dimmable Lights, 2.5 watts	4 Consumable Replaceable LED, 7.5 watts
Filter Type	Aluminum Mesh Filter + Perimeter Aspiration	Dishwasher Safe, Aluminum Grease Filter, Perimeter Aspiration	2 Dishwasher-Safe, 2 Professional Stainless Steel Angled Baffle Filter
Duct Transition	6" Round with Back Draft Damper (Top Only)	6" Round with Back Draft Damper (Top Only)	8" Round with Back Draft Damper (Top Only)
Installation Type	Ducted or Recirculating	Ducted or Recirculating	Ducted Installation Only
Electrical	120 V - 60 Hz 530 Wattage	120 V - 60 Hz 530 Wattage	120 V - 60 Hz 800 Wattage

			
Model Name	Maggiore	Meteorite Island	Vavano Island
Model Numbers	EMG636S1 EMG642S1	EMI648SS	EVI642S1 EVI648S1
Dimensions	36"W x 19 11/16"D x 1 9/16"H 42"W x 19 11/16"D x 1 9/16"H	48"W x 24"D x 2 3/8"H	42"W x 24"D x 5"H 48"W x 24"D x 5"H
Blower Type	600 CFM(4-speed)	550 CFM(4-speed)	600 CFM(4-speed) (1200 CFM Inline and External blowers available)
Blower Performance	Speed 1, 160 CFM Speed 2, 280 CFM Speed 3, 470 CFM Speed 4, 600 CFM	Speed 1, 192 CFM Speed 2, 310 CFM Speed 3, 450 CFM Speed 4, 550 CFM	Speed 1, 205 CFM Speed 2, 350 CFM Speed 3, 510 CFM Speed 4, 600 CFM
CFM Reduction	Yes	No	No
Noise (sones)	Min: 1.73, Max: 6.0	Min: 1.7, Max: 7.0	Min: 3.21, Max: 7.7
Finish	Stainless Steel + Black Glass	Stainless Steel + Black Glass	Stainless Steel
Controls	Touch Controls 3 Speed + Booster	Touch Controls 3 Speed + Booster (Sensor)	Fully Retractable Rotating Knobs w/ Blue Backlighting
Illumination	4 Premium LED Dimmable Lights, 2.5 watts	Strip LED 7 watts 2700 - 6000K, Tunable White	4 Consumer Replaceable LED, 7.5 watts
Filter Type	3 Dishwasher-Safe, Stainless Steel Microhole Filter	Dishwasher-Safe, Aluminum Grease Filter, Perimeter Aspiration	Dishwasher-Safe, 3 Professional Stainless Steel Angled Baffle Filters
Duct Transition	6" Round with Back Draft Damper (Top only)	6" Round with Back Draft Damper (Top Only)	8" Round with Back Draft Damper (Top Only)
Installation Type	Ducted or Recirculating	Ducted or Recirculating	Ducted Installation Only
Electrical	120 V - 60 Hz 426.2 Wattage	120 V - 60 Hz 530 Wattage	120 V - 60 Hz 480 Wattage

Curved Glass Island

			
Model Name	Potenza	Como	Cingoli
Model Numbers	EPT430S2 EPT436S2	ECM630S3 ECM636S3	ECN636S3 ECN642S3
Dimensions	30"W x 19 5/8"D x 1 15/16"H 36"W x 19 5/8"D x 1 15/16"H	30"W x 19 11/16"D x 1 15/16"H 36"W x 19 11/16"D x 1 15/16"H	36"W x 25 3/16"D x 1 15/16"H 42"W x 25 3/16"D x 1 15/16"H
Blower Type	400 CFM(3-speed)	600 CFM(4-speed)	600 CFM(4-speed)
Blower Performance	Speed 1, 160 CFM Speed 2, 280 CFM Speed 3, 400 CFM	Speed 1, 160 CFM Speed 2, 280 CFM Speed 3, 470 CFM Speed 4, 600 CFM	Speed 1, 160 CFM Speed 2, 280 CFM Speed 3, 470 CFM Speed 4, 600 CFM
CFM Reduction	Yes/ KITO2748	Yes	Yes
Noise (sones)	Min: 0.91, Max: 5.9	Min: 2.36, Max: 6.0	Min: 2.36, Max: 6.0
Finish	Stainless Steel	Stainless Steel + Black Glass	Stainless Steel + Black Glass
Controls	Backlit Electronic Push Button	Touch Controls 3 Speed + Booster	Touch Controls 3 Speed + Booster
Illumination	2 LED, 2.1 watts	2 Premium LED Dimmable Lights, 2.5 watts	2 Premium LED Dimmable Lights, 2.5 watts
Filter Type	Dishwasher-Safe, Anodized Aluminum Mesh Filter	Dishwasher-Safe, Stainless Steel Microhole Filter	1 Dishwasher-Safe, Stainless Steel Micro Hole Grease Filter
Duct Transition	6" Round with Back Draft Damper (Top Only)	6" Round with Back Draft Damper (Top Only)	6" Round with Back Draft Damper (Top Only)
Installation Type	Ducted or Recirculating	Ducted or Recirculating	Ducted or Recirculating
Electrical	120 V - 60 Hz 300 Wattage	120 V - 60 Hz 530 Wattage	120 V - 60 Hz 530 Wattage

	Ceiling	Down Draft	Outdoor
			
Model Name	Siena	Rise	Capri
Model Numbers	ESNX43S1	ERS630S1 ERS636S1	ECP136SS ECP148SS
Dimensions	43"W x 27"D x 7 3/4"H	30"W x 12 1/2"D x 14"H 36"W x 12 1/2"D x 14"H	36"W x 32"D x 18"H 48"W x 32"D x 18"H
Blower Type	600 CFM In Line (4-speed)	600 CFM(4-speed)	1200 CFM(4-speed) Internal or external
Blower Performance	Speed 1, 160 CFM Speed 2, 280 CFM Speed 3, 470 CFM Speed 4, 600 CFM	Speed 1, 205 CFM Speed 2, 350 CFM Speed 3, 510 CFM Speed 4, 600 CFM	Speed 1, 375 CFM Speed 2, 640 CFM Speed 3, 940 CFM Speed 4, 1200 CFM
CFM Reduction	No	No	No
Noise (sones)		Min: 1.9, Max: 8.0	Min: 2.47, Max: 9.04
Finish	Stainless Steel	Stainless Steel	Corrosion Resistant Grade Stainless Steel
Controls	Remote Control	Rotative Touch Control	Fully Retractable Rotating Knobs w/ Blue Backlighting
Illumination	4 LED, 2.5 watts		2 LED, 7.5 watts (36") 4 LED, 7.5 watts(48") <small>*Consumer Replaceable</small>
Filter Type	Dishwasher Safe Perimeter Aspiration, Aluminum Mesh Filter	Perimeter Aspiration (Aluminum Mesh Filter Behind)	Dishwasher-Safe, Professional Stainless Steel 4w/36", 6w/48"
Duct Transition	5 way, 6" Round	6" Round with Back Draft Damper (Side)	10" Round with Back Draft Damper (Top Only)
Installation Type	Ducted Installation Only	Ducted Installation Only	Ducted Installation Only
Electrical	120 V - 60 Hz 365 Wattage	120 V - 60 Hz 410 Wattage	120 V - 60 Hz 913 W attage

					
Model Name	Easy	Wave	Chrome	Twin	Star
Model Numbers	EES320SS EES320WT	EWV320SS	ECH623S1	ETP536SS	EST319GL
Dimensions	19 3/4"W x 19 3/4"D x 16 7/8"H	19 3/4"W x 19 3/4"D x 16 7/8"H	22 7/8"W x 17"D x 22 7/8"H	35 7/16"W x 19 11/16"D x 14 3/16"H	18 5/16"W x 18 5/16"D x 13 1/2"H
Blower Type	355 CFM(4-speed)	350 CFM(3-speed)	600 CFM(4-speed)	550 CFM(4-speed)	300 CFM(4-speed)
Blower Performance	Speed 1, 102 CFM Speed 2, 165 CFM Speed 3, 240 CFM Speed 4, 355 CFM	Speed 1, 110 CFM Speed 2, 220 CFM Speed 3, 350 CFM	Speed 1, 195 CFM Speed 2, 340 CFM Speed 3, 500 CFM Speed 4, 600 CFM	Speed 1, 200 CFM Speed 2, 325 CFM Speed 3, 450 CFM Speed 4, 550 CFM	Speed 1, 100 CFM Speed 2, 175 CFM Speed 3, 250 CFM Speed 4, 300 CFM
CFM Reduction	No	No	No	No	No
Noise (sones)	Min: 1.65, Max: 5.0	Min: 0.3, Max: 3.8	Min: 0.7, Max: 4.8	Min: 0.31, Max: 4.3	Min: 0.31, Max: 4.1
Finish	Stainless Steel / White	Stainless Steel	Stainless Steel	Stainless Steel	Glass Crystals + Stainless Steel
Controls	Touch Control 3S + Booster	Electronic Backlit Push Button	Magic Wand	Magic Wand	Magic Wand
Illumination	3 LED, 5 watts	6 LED, 2 watts	2 LED, 3 watts	8 LED, 2 watts	1 LED, 2 watts
Filter Type	1 Dishwasher-Safe, Perimeter Aspiration+ Aluminum Mesh Filter 1 Carbon Long Life Filter	Dishwasher-Safe, Aluminum Mesh Grease Filter, 1 Long Life Carbon Filter	1 EDS Dishwasher-Safe Anodized Aluminum Mesh Grease Filter	Dishwasher-Safe, 2 Aluminum Mesh Grease Filter, 2 Long Life Carbon Filter	1 Dishwasher-Safe, Aluminum Mesh Grease Filter, Long Life Carbon Filter
Installation Type	Recirculating Installation Only	Recirculating Installation Only	Ducted or Recirculating	Recirculating Installation Only	Recirculating Installation Only
Electrical	120 V - 60 Hz 460 Wattage	120 V - 60 Hz 320 Wattage	120 V - 60 Hz 490 Wattage	120 V - 60 Hz 320 Wattage	120 V - 60 Hz 320 Wattage

		
Model Name	NikolaTesla	Golden
Model Numbers	ENT432BL	EGL324BL EGL430BL EGL536BL
Dimensions	32 1/16"W x 20 1/16"D x 8 1/4"H	23 3/4"W x 20 3/4"D x 2 1/4"H 29 3/4"W x 20 3/4"D x 2 1/4"H 35 3/4"W x 20 3/4"D x 2 1/4"H
Blower Type	400 CFM(4-speed)	
Blower Performance	Speed 1, 160 CFM Speed 2, 250 CFM Speed 3, 350 CFM Speed 4, 400 CFM (Booster)	
Noise (sones)	Min: 2.2, Max: 5.0	
Cooking Zones:	4 (2,1 - 3,7 kW) - 7,1 x 7,9 inches	3 Cooking Zones + 1 Bridge Zone (24") 4 Cooking Zones + 1 Bridge Zone (30") 5 Cooking Zones + 2 Bridge Zones (36")
Heating Level:	9 Levels + Booster	9 Levels + Booster
Finish	Black Glass	Black Glass
Controls	Slider Touch Control 3S + Booster Ventilation	Electronic Glass Touch with Finger Glide Function
Installation Type:	Ducted or Recirculating Self Rimming or Flush Mounted	Self Rimming or Flush Mounted
Filter Specification:	6 Layer Anodized Aluminum Mesh Grease Filter	
Electrical	208 - 240 V - 60 Hz 440 Watts at 3.3 Amps 240 V - 7.8 kW at 32.5 Amps 208 V - 7.1 kW at 34.1 Amps	(24" & 30") 208 - 240 V - 60 Hz 7.7 kW at 32.1 Amps 6.7 kW at 32.2 Amps (36") 208 - 240 V - 60 Hz 11.5 kW at 47.9 Amps 10 kW at 48.1 Amps

