

SYNTHESIS ELECTRONIC CONTROLS

body / chimney / control components

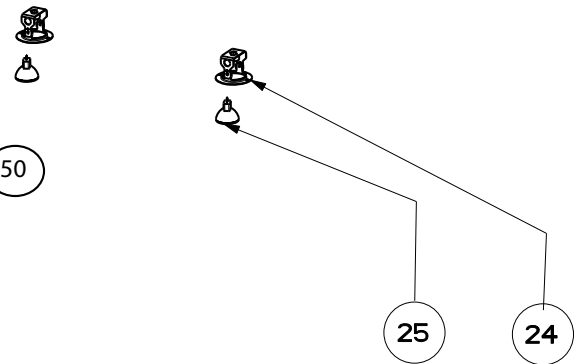
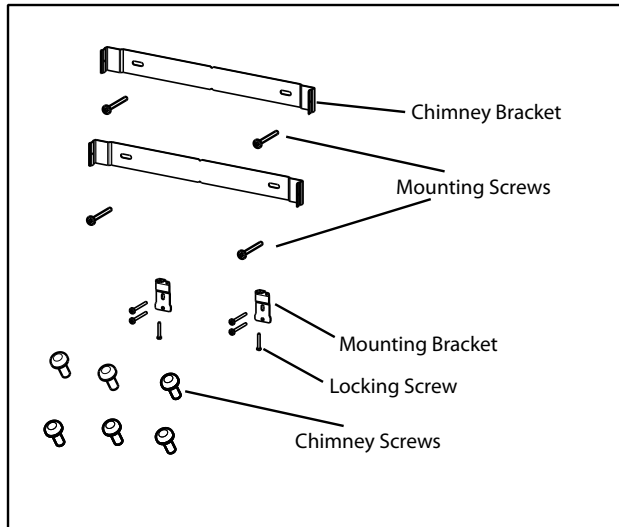
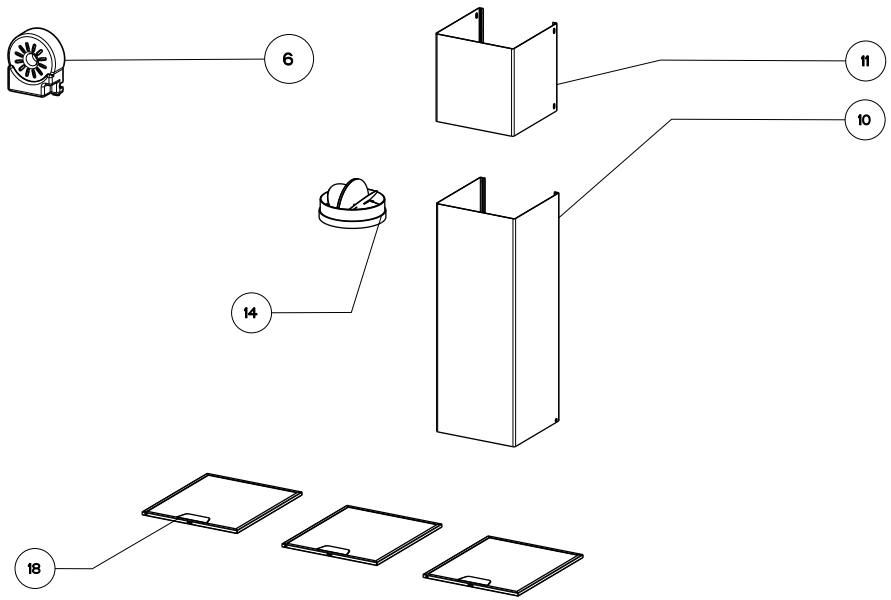

Key	Model Number	SYNT30SS	SYNT36SS	SYNT30SS300	SYNT36SS300	Qty Req.
6	Transformer	133.0052.516	133.0052.516	133.0052.516	133.0052.516	1
10	Lower Chimney	133.0017.173	133.0017.173	133.0017.173	133.0017.173	1
11	Upper Chimney	133.0072.331	133.0072.331	133.0072.331	133.0072.331	1
14	Damper	133.0055.994	133.0055.994	133.0055.994	133.0055.994	1
18	Grease Filter	133.0017.054	133.0017.054	133.0017.054	133.0017.054	30 = 2, 36 = 3
24	Light Housing	133.0052.517	133.0052.517	133.0052.517	133.0052.517	2
25	Halogen Bulb	133.0046.418	133.0046.418	133.0046.418	133.0046.418	2
50	Mounting Kit	133.0084.475	133.0084.475	133.0084.475	133.0084.475	1

SYNTHESIS ELECTRONIC CONTROLS

switch components

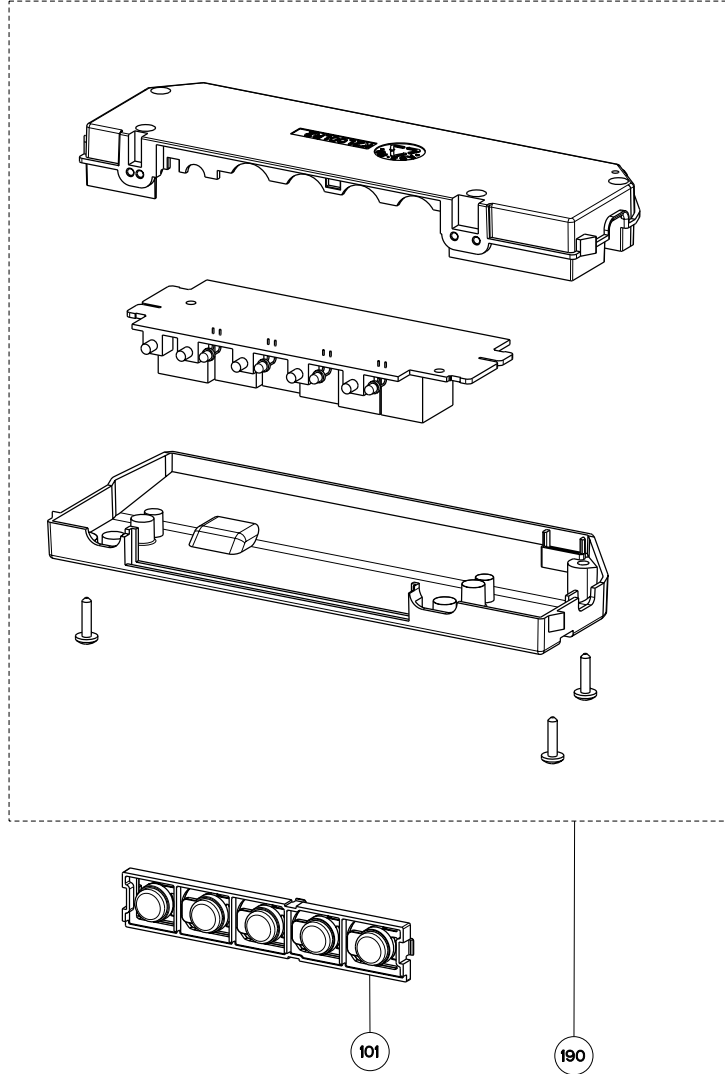

	Model Number	SYNT30SS	SYNT36SS	SYNT30SS300	SYNT36SS300	
Key	Description	30	36	30 - 300 cfm	36 - 300 cfm	Qty Req.
101	Control Button Kit	133.0176.906	133.0176.906	133.0176.906	133.0176.906	1
190	Switchboard Kit	133.0176.907	133.0176.907	133.0176.907	133.0176.907	1

SYNTHESIS ELECTRONIC CONTROLS

motor components

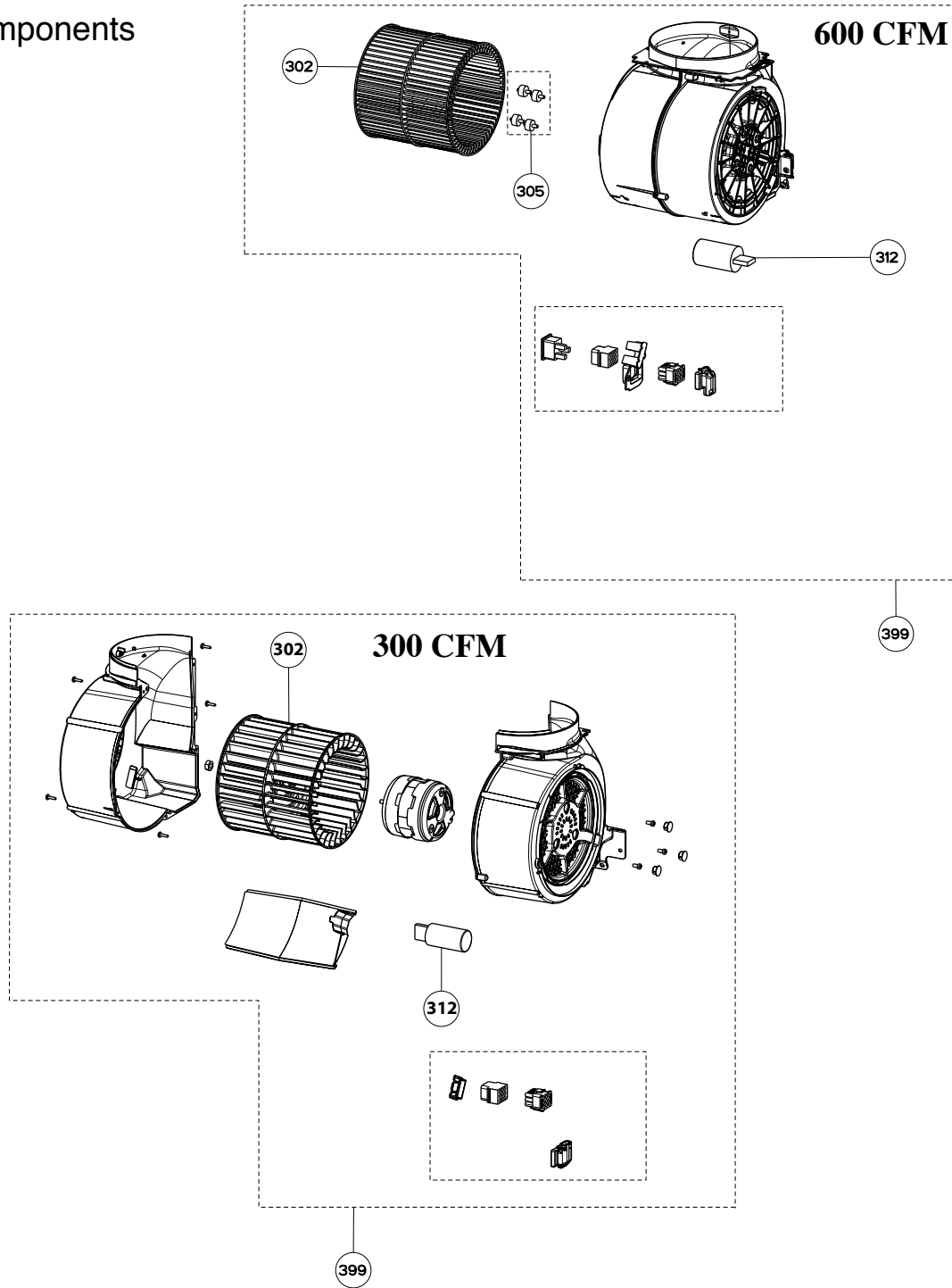

	Model Number	SYNT30SS	SYNT36SS	SYNT30SS300	SYNT36SS300	
Key	Description	30	36	30 - 300 cfm	36 - 300 cfm	Qty Req.
302	Impeller Kit	133.0052.799	133.0052.799	133.0178.632	133.0178.632	1
305	Rubber Motor Mount	133.0051.604	133.0051.604			1
312	Capacitor	133.0060.648	133.0060.648	133.0071.827	133.0071.827	1
399	Motor Kit	133.0052.798	133.0052.798	133.0178.492	133.0178.492	1