

Dishwasher

use & care

Introduction.....	2	Care and Cleaning	19
Important Safety information.....	3	Saving Energy	21
Features.....	5	Normal Operating Sounds	22
Controls and Settings.....	6	Troubleshooting.....	23
Operating Instructions	10	Limited Warranty	27

2

INTRODUCTION

Welcome to our family

Thank you for bringing Frigidaire into your home! We see your purchase as the beginning of a long relationship together.

This manual is your resource for the use and care of your product. Please read it before using your appliance. Keep it handy for quick reference. If something doesn't seem right, the troubleshooting section will help you with common issues.

FAQs, helpful tips and videos, cleaning products, and kitchen and home accessories are available at www.frigidaire.com.

We are here for you! Visit our website, chat with an agent, or call us if you need help. We may be able to help you avoid a service visit. If you do need service, we can get that started for you.

Let's make it official! Be sure to register your product.

Keep your product info here so it's easy to find.

Model Number _____

Serial Number _____

Purchase Date _____



NOTE

The dishwasher is programmed to remember your last cycle so you do not have to reset each time. To start the dishwasher using the same cycle and options selected on the previous wash, just press the START pad.



NOTE

Not all cycles and options available on all models.



NOTE

The filters will need to be cleaned to maximize wash performance during the life of your dishwasher. See "Recommended Frequency to Clean Your Filters" for a cleaning schedule.



NOTE

Very Important Information - Read Before Operating Your Dishwasher!

Normal Operating Sounds

This dishwasher does not sound like most dishwashers - IT'S QUIETER.

Your Direct Feed Wash System dishwasher uses energy efficient motors for the wash and drain portions of the cycle you select. Each cycle has a series of water fills and drains for washing and rinsing dishes. As each cycle begins, you may-or may not- hear the drain motor. The next sound you will hear is the splashing water as it enters the tub.

PLEASE BE ADVISED: If you compare this dishwasher to previous models, you may be surprised at what you DON'T hear.



NOTE

Why Energy Efficient Units run long cycles: Several factors are important to washing dishware. The energy use of the dishwasher was reduced by applying more of the factors that don't use so much energy and less of the ones that use more. As a result, you will see that the wash cycles take longer.



WARNING

When using your dishwasher, follow basic precautions, including the following:

For your Safety

- Use your dishwasher only as instructed in this Use and Care Manual.
- This Manual does not cover every possible condition and situation that may occur. Use common sense and caution when installing, operating and maintaining any appliance.
- NSF certified residential dishwashers are not intended for licensed food establishments.
- **DISHWASHER MUST BE ELECTRICALLY GROUNDED.** This appliance must be connected to a ground metal, permanent wiring system, or an equipment-grounding conductor must be run with the circuit conductors and connected to the equipment-grounding terminal or lead on this appliance. Read the Installation Instructions for details.
- This dishwasher is designed to operate on regular house current (120V, 60Hz). Use a circuit equipped with a 15 ampere fuse or circuit breaker. Use a 20 ampere fuse if dishwasher is connected with a food disposer.
- Do not operate dishwasher unless all enclosure panels are in their proper place.
- Keep young children and infants away from dishwasher when it is operating.
- Do not let children abuse, sit, stand or play on door or racks of a dishwasher.
- To reduce the risk of injury, do not allow children to play in or on the dishwasher.
- Use only detergents and rinse agents recommended for use in a dishwasher.
- Store dishwasher detergent and rinse agents out of the reach of children.
- If the dishwasher drains into a food disposer, make sure disposer is completely empty before running dishwasher.
- Do not wash plastic items unless marked: "Dishwasher Safe" or equivalent. Check with manufacturer for recommendations, if not marked. Items that are not marked dishwasher safe may melt and create a potential fire hazard.
- When loading items to be washed:
 - Locate sharp items and knives so that they are not likely to damage the door seal or tub.
 - Load sharp items and knives with the handles up to reduce the risk of cut-type injuries.
- Do not tamper with controls.
- Use care unloading the dishware when the Sanitize option has been selected. Contents may be hot to the touch immediately after the end of cycle.
- Under certain conditions, hydrogen gas may be produced in a hot water system that has not been used for 2 weeks or more. **HYDROGEN GAS IS EXPLOSIVE.** If hot water system has not been used for such a period, before using dishwasher, turn on all hot water faucets and let water flow from each for several minutes. This will release any accumulated hydrogen gas. **HYDROGEN GAS IS FLAMMABLE.** Do not smoke or use an open flame during this time.
- Do not store or use combustible materials, gasoline or other flammable vapors and liquids in the vicinity of this or any other appliance.
- Disconnect electrical power to dishwasher before servicing.
- Repairs should be done by a qualified technician.
- To avoid entrapment and/or suffocation, remove door or door latch mechanism from any dishwasher that is discarded or not in use.

4

IMPORTANT SAFETY INFORMATION



WARNING

To reduce the risk of fire, electrical shock or injury when using your dishwasher, follow the previous basic precautions .



WARNING

Please read all instructions before using this appliance.

Safety Definitions

 This is the safety alert symbol. It is used to alert of potential personal injury hazards. Obey all safety messages that follow this symbol to avoid possible injury or death.



DANGER

DANGER indicates an imminently hazardous situation which, if not avoided, will result in death or serious injury.



WARNING

WARNING indicates a potentially hazardous situation which, if not avoided, could result in death or serious injury.



CAUTION

CAUTION indicates a potentially hazardous situation which, if not avoided, may result in minor or moderate injury.



IMPORTANT

IMPORTANT indicates installation, operation or maintenance information which is important but not hazard-related.

Child Safety

Destroy or recycle the carton, plastic bags, and any exterior wrapping material immediately after the dishwasher is unpacked. Children should **NEVER** use these items to play. Cartons covered with rugs, bedspreads, plastic sheets or stretch wrap may become airtight chambers, and can quickly cause suffocation.

Safety Instructions

- DO NOT store or use gasoline, or other flammable liquids in the vicinity of this or any other appliance. Read product labels for warnings regarding flammability and other hazards.
- Remove all staples from the carton. Staples can cause severe cuts, and also destroy finishes if they come in contact with other appliances or furniture.

SAVE THESE INSTRUCTIONS

Your dishwasher cleans by spraying a mixture of hot water and detergent through the spray arms against soiled surfaces. First, the dishwasher drains for a few seconds to remove soils dropped while loading, then fills with water covering the filter area. Water is then pumped through the spray arms. Soil particles go through and across the filter and down the drain as the water is pumped out. This series of steps are repeated as needed. The number of water fills varies with the cycle being used.

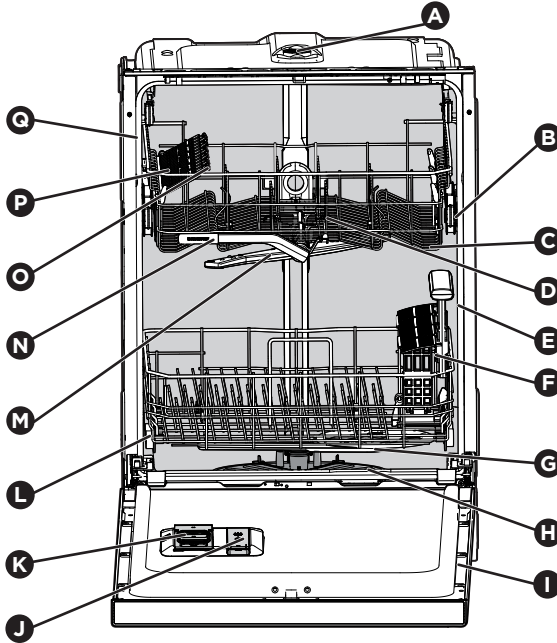

Features may vary according to model

A	Upper Spray Arm
B	Adjustable Rack Mechanism
C	Upper Rack
D	Flex Wash System
E	Interior Light
F	Silverware Basket
G	Lower Spray Arm
H	Filters
I	Serial Label (located on right side of door)

J	Rinse Aid Dispenser
K	Detergent Dispenser
L	Bottom Rack
M	Middle Spray Arm
N	SmartBoost Clean™ Spray Arm
O	Stemware Holder
P	Cup Shelves
Q	Tub Gasket



IMPORTANT

Accessories are available for your appliance and may be purchased at Frigidaire.com or by calling 1-800-374-4432 (Frigidaire.ca or 1-800-265-8352 in Canada) or from an authorized seller.

6

CONTROLS AND SETTINGS

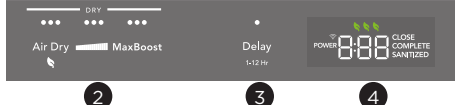
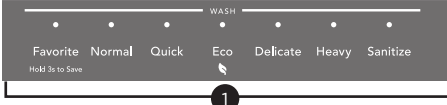

Wash Cycle and Options

Cycle times are approximate and vary by options selected. Hot water is necessary to activate dishwasher detergent and melt fatty food soils.

The Smart Sensor checks the soil level on your dishes in the **NORMAL**, **ECO**, **SANITIZE**, and **HEAVY** cycles. Cycle time and water usage varies based on the amount of soil on the dishes.

Making a Selection

Press the desired cycle or option button on the control panel to make a selection. Each button press plays a tone, and the LED light above the selection turns ON when a cycle or option is selected and OFF when deselected.

Cycle Selection

Press the cycle button to select your desired cycle. The LED light above the cycle illuminates and the estimated cycle time appears in the status window.

To Clear Current Settings:

Press cancel button until the lights on the control panel go out to clear. The last run settings show when the door is opened.

NOTE

A default dry setting is automatically selected and an estimated time along with the eco feedback based on all settings are provided in the status window when a wash cycle is selected.

1 Favorite

This cycle allows you to program your preferred cycle and options into one button. When saving a favorite for the first time, ensure the desired wash cycle and options are selected, then

press the **FAVORITE** button once to initiate the program save, then press and hold until the LED stays lit and a tone is heard to save the current settings as a favorite. Press the **Favorite** button once programmed to select the saved cycle and options, press **Start** and immediately close the door to start the cycle.

To save over the current favorite, select new settings to save as the favorite. Press the favorite button to initiate the save, then press and hold the favorite button until it stays lit and a tone is heard to save the new settings. Press the favorite button to display the saved settings and options.

NOTE

Releasing the Favorite button before the 3 second window to save passes will fail to save the program. The LED above the Favorite button does not light if a program is not saved.

Normal

For light to heavily soiled dishes and silverware. Water usage ranges from approximately 3.0 to 7.4 gallons. Wash time is about 125 min. with Air Dry, 135 min. with Medium Dry, and 193 min. with **MaxBoost**.

Quick

For lightly soiled and pre-rinsed dishes and silverware. Water usage is approximately 4.5 gallons. Wash time is about 30 min. with the Air Dry setting, 60 min. with Medium Dry, and 75 min with **MaxBoost**.

Eco

For lightly soiled and pre-rinsed dishes and silverware. Water usage ranges from approximately 4.3 to 7.7 gallons. Wash time is about 86 min with Air Dry, 96 min. with Medium Dry, and 229 min with **MaxBoost**. 3 **Eco** leaf icons illuminate when the **Eco** cycle is selected.

Delicate

For lightly soiled China and Crystal. Water usage is approximately 4.9 gallons. Wash time is about 95 min. with Air Dry and Medium Dry, and 136 min. with **MaxBoost**.

Heavy

For pots, pans, casserole dishes and dinnerware with dried-on or baked-on soils. Water usage ranges from approximately 7.1 to 8.1 gallons. Wash time ranges from approximately 170 to 214 min.

Sanitize

Select the **Sanitize** cycle to sanitize your dishes and glassware. This cycle heats the water temperature in the final rinse to 157°F (69.4°C) and maintains that temperature for 7 minutes.

The cycle time is extended until the proper water temperature is reached, and washing continues during the water heating delay. For best results, the incoming water temperature should be at least 120°F (49°C). Wash time is about 217 min. with Air Dry, and with Medium Dry, and 231 min. with **MaxBoost**.

The sanitation criteria may not be satisfied if there is an interruption of the cycle, a power failure occurs, or if incoming water temperature is below 120°F (49°C).

When a sanitized cycle has completed, the **Sanitize** LED is illuminated if NSF req. for sanitization are reached. The LED stays on after the door is opened.

If NSF requirements for sanitization are NOT reached the LED is off at cycle end. The LED starts blinks twice then goes out after the door is opened.

Option Selections**2 Selecting a Dry Setting**

Touch and slide to select a dry setting based on the touch release point. Updates to the cycle time display in the status window.

Releasing the slide input between dry programs will select the Medium Dry program.

Air Dry

If the **Air Dry** option is selected, the heating element is not used during the dry cycle. This reduces energy consumption and drying performance. Items in the dish load may not be dry at the end of the cycle.

MaxBoost

The cycle time increases when **MaxBoost** is selected.

**NOTE**

If the selected dry setting is unavailable for the selected wash cycle, the LED above the dry option will blink three times and then turn off indicating that the dry option was not selected.

Operation Selections**3 Delay**

The **Delay** option allows you to automatically delay starting your dishwasher from 1-12 hours.

Select your desired cycle and options, then press the **Delay** button to advance the delay time in one-hour increments until desired time delay is reached. Pressing the delay button displays the delayed time in the status window and illuminates the LED above the **Delay** button to indicate a delay is active. The delay time function is canceled if the delay time button is pressed again when 12 hours of the selected delay time. Press and hold the delay button to quickly cycle through the delay time from 1-12 hours.

8

CONTROLS AND SETTINGS

Press **START** and close the door immediately (within 4 seconds). A tone indicating that countdown has started sounds while the Close Door LEDs blink. The selected cycle starts when the countdown is completed. If the cycle was not yet started, to cancel a delay time press the delay button until the time returns to zero. If the cycle has started pressing the CANCEL button will reset both the cycle and the delay options.

When a time delay is set for an hour or more and the wash hasn't started, the remaining delay time counts down on the display in full hour increments.

When the delay time is less than 1h, the remaining delay time counts down in hour and min (0:59), and the delay LED is illuminated during the delay countdown.

4 Status Window

The status window indicates the number of delay start hours, the number of minutes left in a cycle, the level of rinse aid dosage, and the cycle prompts.

5 Start

The LEDs of the selected cycle and options are illuminated when the cycle and options are selected. The status window displays the cycle time and the START LED blinks.

Press **START** and close the dishwasher door immediately (within 4 seconds) to start the cycle.

Once the START button is pressed the corresponding LED stops blinking and stays on. The CLOSE LED blinks and a reminder tone sounds every 30 seconds until START or CANCEL is pressed or if the door is closed without pressing start. The tone will sound a maximum of 5 times.

The blue floor indicator light illuminates to indicate the washer is running. During the cycle, buttons are disabled, displaying the cycle and options selected, and the time left for the wash is displayed on the status window.

If a cycle is paused the floor indicator Light stays ON until the door is opened.



NOTE

The start of the cycle times out if the door is not closed immediately (within 4 seconds) after pressing **START**.

6 Cancel

Both a running cycle and a delay countdown can be canceled at any time. Open the dishwasher door and press **Cancel**. A tone will sound indicating that the cycle has been successfully canceled.

If desired, a new cycle can now be selected, by pressing **Start** and closing the door immediately, the new cycle will begin.

If you have selected your cycle and options and decide to cancel, press **Cancel**, the unit will go into a standby mode and all LED lights will turn off.

7 Control Lock

Control Lock locks the controls to avoid accidental button presses, for example while cleaning the control panel.

To lock the control panel, press and hold the **Control Lock** button. The LED above the button blinks and then stays lit when the controls are locked.

When locked, all lights on the control panel including the **Control Lock** LED are off when the door is closed, and only the control lock LED lights when the door is opened.

To unlock the controls, open the door and press and hold the **Control Lock** button until it blinks and turns off. The control panel shows the selected last wash and dry cycle after the controls are unlocked.



NOTE

If the **Control Lock** button is released before it begins to blink the control panel will remain locked. Hold the control lock button until it stops blinking and turns off to ensure the controls have been unlocked.

**NOTE**

The **Control Lock** LED will blink three times and then stay lit if any buttons are pressed while control lock is active.

Opening the Door During Operation

**NOTE**

Opening the door during normal operation pauses the wash cycle.

When the door is opened a running cycle is paused. Once the **Start** button is pressed the corresponding LED stops blinking and stays on and the **Close** LED blinks. If the door is not closed within 4 seconds the **Start** LED will blink, and a reminder tone sounds every 30 seconds until **Start** or **Cancel** is pressed. The tone will sound a maximum of 5 times. If a cycle is paused the floor indicator light stays ON until the door is open. If the door is closed without pressing the **Start** button, The floor indicator light turns off. If the cycle is paused it is not possible to change program or options unless the running one is canceled.

Change Options After a Wash or Delayed Wash Starts

A running wash cycle must be canceled to reselect options for a running cycle.

**NOTE**

If the dishwasher door is kept open for too long, or the door is closed without pressing the **START** button, the running cycle or delay countdown may be canceled.

If the newly selected wash option cannot be selected, the LED button for that option will blink 3 times and then turn off.

To Resume a Wash

If cycle is paused, the floor indicator light stays ON until the door is open. If the door is closed without pressing start, the floor indicator turns off.

Once the **Start** button is pressed the corresponding LED stops blinking and stays on and the **Close** LED blinks. If the door is not closed within 4 seconds the **Start** LED will blink, and a reminder tone sounds every 30 seconds until **Start** or **Cancel** is pressed. The tone will sound a maximum of 5 times.

Open the door to enable the buttons, press **Start** and close the door within 4 seconds to resume the wash cycle.

The control panel will go into sleep mode if there is no interaction with the **Start** button, door, or other buttons for a period of 5 minutes.

Cancel a Wash

Press the **Cancel** button to cancel a running wash cycle. When a cycle is canceled, the tub drains either on door close within 4 seconds upon touching the **Cancel** button (to avoid soiled water sitting in the tub) or at the beginning of the next wash.

When a wash is canceled, the tub will drain of any water for about 1 minute during which the LED above the **Cancel** button and the floor indicator light are lit.

**NOTE**

Opening the door while the dishwasher is draining will cancel the drain cycle. Draining will then complete before the next wash starts.

10

OPERATING INSTRUCTIONS

Status Window



The STATUS window, available on some models, indicates the following activity:

1-12h	Indicates number of delay start hours for selected cycle.	ECO Leaves	Selecting a wash setting automatically selects the default dry setting. Each wash and dry setting displays the Eco feedback above the wash time in the display window. 1, 2, or 3 leaves displays depending on the water and energy required to run the wash cycle and options selected, with one leaf using highest energy consumption and 3 the lowest.
MINUTES	The cycle duration or the remaining time shown in H:MIN the format (ex: 0:30).		
LO-L6	Level of Rinse Aid dosage.		

Floor Indicator Light

The display on floor indicates the following activities:

White

The wash cycle is complete. The floor indicator light will turn off once the door is opened.

Blue

The wash cycle is running

Cycle Completes

When a wash cycle is finished, the **COMPLETE** LED and the white beam on floor illuminate. These lights remain on until the door is opened.

All lights on the control panel go off 15 seconds after the door has been opened. Last run settings display on the control panel when the door is opened.

User Instruction Code

Instruction Code	Problem	Solution
Close	This indicates the door has been left open or not properly latched.	Ensuring the door is properly latched will clear the display. This does not indicate a problem with your dishwasher and service will not need to be contacted.

Error Code

Error Code*	Problem	Solution
E10	A low fill has been detected.	Look for a pinched water supply line, or water shutoff is not completely opened.
E20; E40; EFO	Clogged filters or a restricted drain line has been detected.	Check and clean both filters and sump area and check for a pinched or blocked drain hose. If the drain line is attached to a disposer, check that the knockout plug has been removed.
E30	A leak or overflow of water has been detected in the bottom pan.	Look for loose connections at the water inlet valve and ensure the unit is properly leveled.
E50	A problem has been detected with the drain or wash motor.	Pressing the cancel button or turning power off at the breaker for 5 min. should clear this error code and the unit can be restarted.
E60	A problem has been detected with the water heating system.	Call the Frigidaire Customer Care Center at 1-800-944-9044. If this does not resolve the problem.
ECO	A problem has been detected with the electronic control system.	

NOTE

Racks and features in your dishwasher model may vary in appearance from illustrations in this manual.

Preparing the Dishes

Scrape away large pieces of food, bones, pits, toothpicks, etc. The continuously filtered wash fluid will remove remaining food particles. Burned-on foods should be loosened before loading. Empty liquids from glasses and cups.

Foods such as mustard, mayonnaise, vinegar, lemon juice and tomato based products may cause discoloration of stainless steel and plastics if allowed to sit for a long period of time. Unless the dishwasher is to be operated at once, it is best to pre-rinse or use the **RINSE** cycle to rinse off these food soils.

Load racks so that large items do not prevent the detergent dispenser from opening.

Check manufacturer's recommendations before washing items in question.

If the dishwasher drains into a Food Disposer, be sure disposer is completely empty before starting dishwasher.

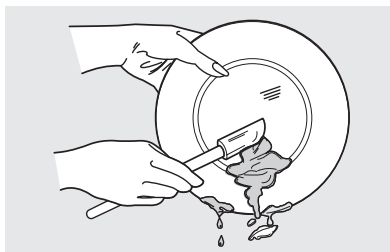

Loading the Dishes

Loading the Cutlery Rack

Features and appearance of racks and silverware basket may vary from your model.

The cutlery rack is designed for flatware and most cooking or serving utensils. Heavily soiled utensils or items with baked on foods should be placed in the upper rack or silverware basket for best washing performance. The separators on the cutlery racks help keep flatware separated to avoid damage and improve cleaning.

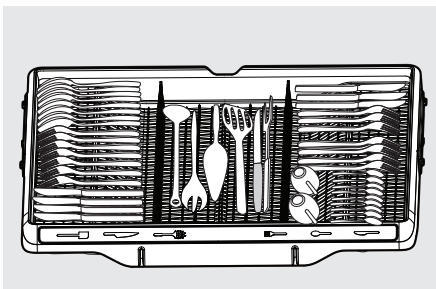

NOTE

Load cutlery as suggested with cutlery handles placed inwards to optimize cleaning performance.

Loading the Upper Rack

Features and appearance of racks and silverware basket may vary from your model.

The upper rack is designed for flexibility in loading a wide variety of items including cups, glasses, stemware, small plates, bowls, etc.

- Load glasses and plastic items in upper rack only.
- Load items with open end facing down for better cleaning and draining.
- Long-handled knives and utensils can be placed in upper rack.

Be sure nothing protrudes through the bottom of the rack to block rotation of the spray arm.



IMPORTANT

Make sure the loaded items do not interfere with the rotation of the spray arm. Check this by rotating the spray arm by hand.



IMPORTANT

Damage may occur if delicate items touch each other during dishwasher operation.

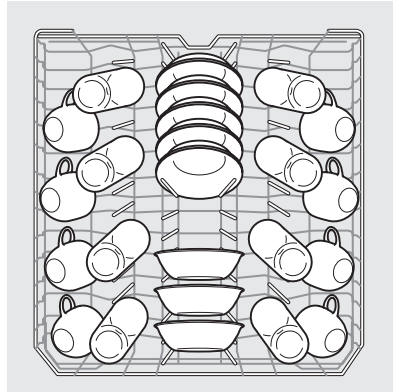

8 place settings standard loading pattern

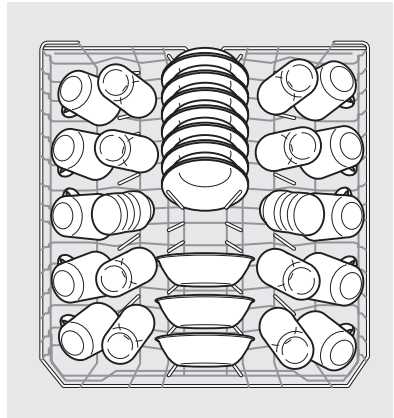

10 place settings standard loading pattern

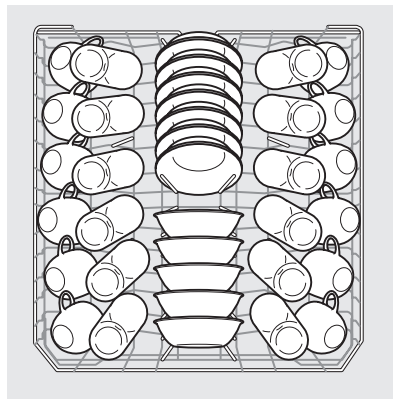

12 place settings standard loading pattern

14 OPERATING INSTRUCTIONS

Flex Wash System

The Flex Wash system gives you the ability to wash the inside areas of baby bottles, narrow glassware and other items. To turn this feature on turn these clips to have them pointing upward (B). To turn off just slide them back down toward the rack (A). See images below.

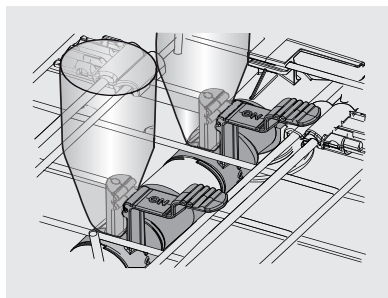
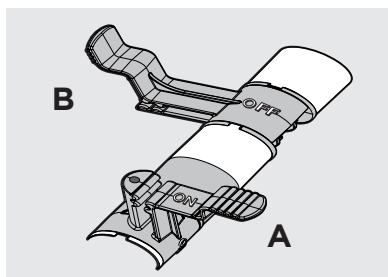

Adjusting the upper rack

The top rack height can be easily adjusted to accommodate loading taller dishes in either rack. To raise the rack to the upper position, lift rack until both sides are at the same height and the rack will secure in place. Ensure that the rack remains level from front to back with both sides at the same height. To lower rack lift the rack slightly then push down and release.

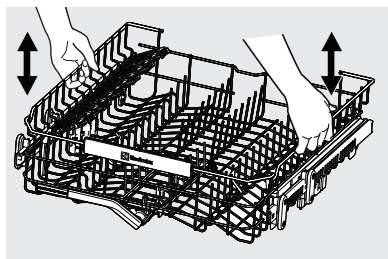

Fold-Down Tines for Upper Rack

The fold-down tines in the top and bottom racks makes it easy to load those extra large and hard-to-fit items. The tines may be left up for normal use or folded down for more flexible loading.

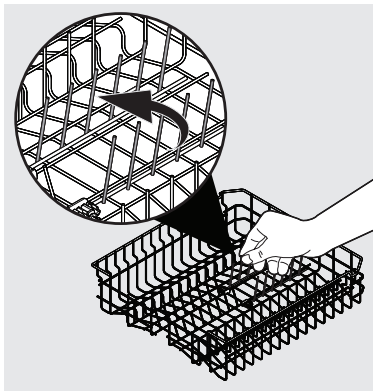
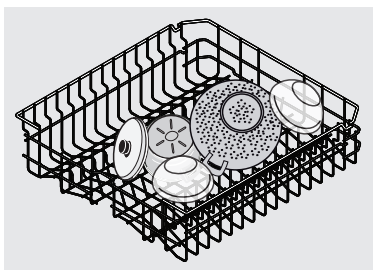

Cup shelf/stemware holders

The Cupshelf holder can be folded down to be used to load two levels of cups, juice glasses, and other short items or fold down both and use for long items such as utensils and spatulas. Fold up to load tall glasses.

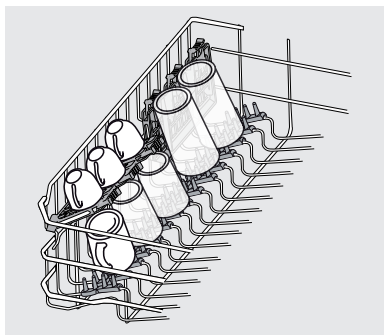

The Stemware holder is used to securely hold your wine glasses in place for the best wash. To properly secure your glass simply press the stem of the glass into the center of the Cupshelf the plastic pieces will secure around the stem to hold the glass in place.

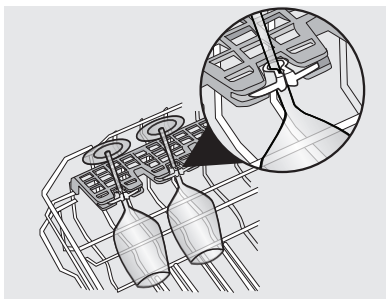

Loading the bottom rack

Features and appearance of racks and silverware basket may vary from your model.

The lower rack is best for plates, saucers, bowls, and cookware. Large items should be placed along the edge so they do not block the spray arm rotation.

For best results, place bowls, casseroles, and sauce pans with soiled surface facing down or toward the center. Tilt slightly for better drainage.

Be sure pan handles do not protrude through the bottom of the rack and block the spray arm rotation.



IMPORTANT

Make sure the loaded items do not interfere with the rotation of the spray arm. Check this by rotating the spray arm by hand.

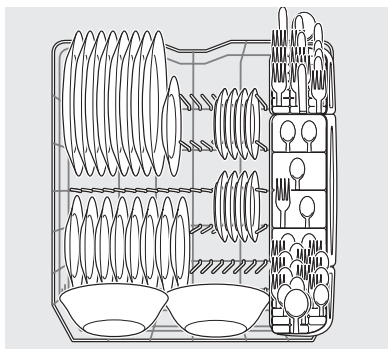

8 place settings standard loading pattern

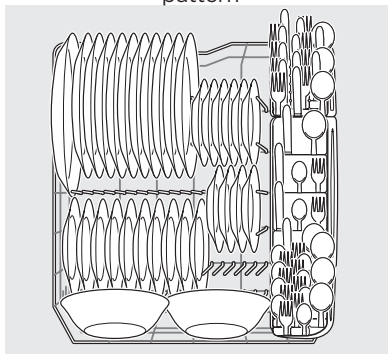

10 place settings standard loading pattern

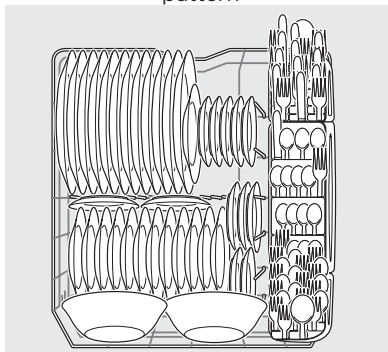

12 place settings standard loading pattern

16

OPERATING INSTRUCTIONS

Fold-down tines lower rack

The fold-down tines in the top and bottom racks makes it easy to load those extra large and hard-to-fit items. The tines may be left up for normal use or folded down for more flexible loading.

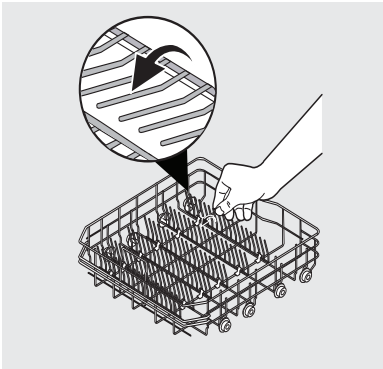
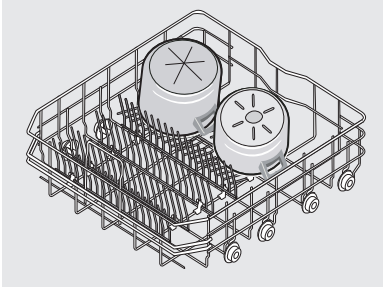

Loading the silverware basket

Features and appearance of racks and silverware basket may vary from your model.

WARNING

Load sharp items (knives, skewers, etc.) pointing down. Failure to do so may result in injury.

Load the silverware basket while it is in the bottom rack or take the basket out for loading on a counter or table.

In some models small items like baby bottle caps, jar lids, corn cob holders, etc., can be placed in a covered section. Close the cover to hold small items in place.

Use suggested loading patterns, as shown, to increase washability of the silverware.

Be sure nothing protrudes through bottom of basket or rack to block the spray arm.

Do not mix silver and stainless to avoid damaging the silver finish.

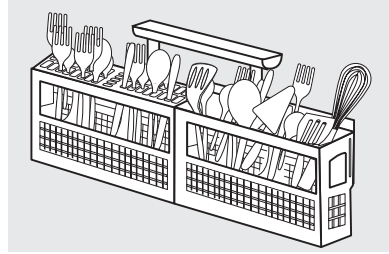

When covers are up, mix items in each section of the basket with some pointing up and some down to avoid nesting. Water spray cannot reach nested items.



IMPORTANT

Make sure the loaded items do not interfere with the rotation of the spray arm. Check this by rotating the spray arm by hand.

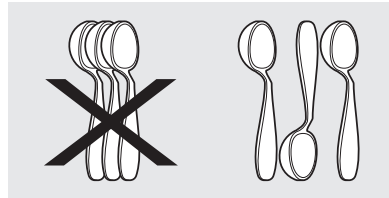

Adding a dish

To add or remove items after wash cycle starts:

Unlatch door and wait a few seconds until wash action stops before opening.

Add the item. To resume cycle, press **START** and immediately close the door firmly to latch.

Dishwasher dispenser and detergents

SmartBoost™ Clean

This dishwasher includes the SmartBoost™ Clean system. SmartBoost™ Clean features a separate spray arm that directly sprays the detergent compartment which aids in dissolving detergent faster. This reduces detergent residue left on the dishes and in the dish compartment.

Filling the detergent dispenser

The detergent dispenser has one covered cup. The covered cup opens automatically to release detergent.

To add detergent:

1. Press the dispenser cover latch to open the main wash detergent cup.
2. Add the recommended amount of detergent to the main wash cup.
3. Slide the main wash cover back over the main wash cup to close.

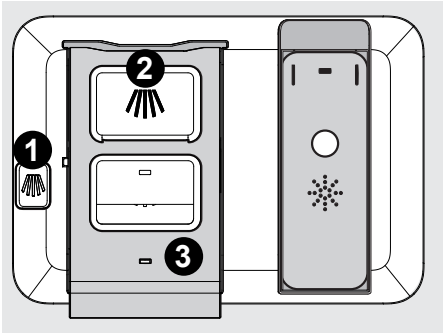

- Use only fresh automatic dishwashing detergent. Other detergents may cause oversudsing.
- When using automatic dishwashing detergent tabs, place one tab in main wash cup and close.
- Add detergent just before starting cycle.
- Store detergent in a cool, dry location. Moist or caked detergent may not dissolve properly.

NOTE

Hard water may cause lime deposit buildup on the interior of the dishwasher. For cleaning instructions see “Removing Spots and Film” section.

CAUTION

The use of industrial grade detergent can damage parts of the dishwasher leading to damage to the unit and surrounding property. Use only household grade automatic dishwasher detergent.

How much detergent to use

The amount of detergent to use depends on the water hardness. Water hardness is measured in grains per gallon. Using too little detergent can result in poor cleaning and hard water filming or spotting. Using too much detergent in soft water can cause etching to some glassware which is surface damage that appears like a film but cannot be wiped off. Your local water company, water softener company or county extension agent can tell you the water hardness in your area.

Dosage of detergent

Place a single detergent tablet or packet into the detergent dispenser compartment.

Detergent usage chart			
Water Hardness	Soft Water (0-3 grains)	Medium Hard Water (4-8 grains)	Hard Water (9-12 grains)
Amount (teaspoons)	4 teaspoons	6 teaspoons	8 teaspoons
Dispenser cup level:	first line	second line	full

18 OPERATING INSTRUCTIONS

Filling the rinse aid dispenser

Rinse aid greatly improves drying, reduces water spots, filming, and lubricates wash arm bearing for proper rotation. With it water “sheets” off dishes rather than forming water droplets that cling and leave spots.

A dispenser, located next to the detergent cup, automatically releases a measured amount of rinse aid during the last rinse. If spotting and poor drying are problems, increase the amount of rinse aid dispensed. The indicator will be dark when full, and the status window will show

To add liquid rinse aid:

1. Lift up the rinse aid cover to open.
2. Fill the rinse aid dispenser with liquid rinse aid until the liquid reaches the indicated fill level. DO NOT overfill.
3. Press the rinse aid cover down firmly to close.
4. Wipe up any spills with a damp cloth.

The dispenser holds enough for 11 to 66 washes, depending on setting.

NOTE

When using multi-product detergent tablets or All-In-One packs with a rinse aid component, the rinse aid dispenser should be set at the lowest setting (**L1**).

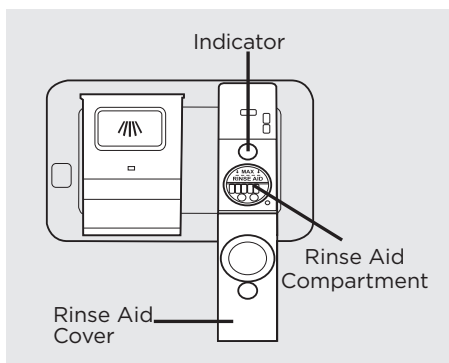

NOTE

Not selecting the **AIR DRY** option in combination with rinse aid will enhance drying performance. The energy required to use the **AIR DRY** option saves pennies per cycle. You may choose to select the **AIR DRY** option; however you will have items in your dish load that will not be completely dry at the end of the cycle.

How to adjust the rinse aid setting

The rinse aid dosage setting is shown in the status window.



1. Press and hold **NORMAL + DELAY** for **3 seconds** until the status window shows the current rinse aid setting **L0**, - **L6**.
2. Press the **DELAY** button to cycle through to the desired level.
3. The selected setting will be confirmed by pressing start or waiting 5 seconds. The selected setting will blink in the status window while an audible beep confirms that the setting is saved.

NOTE

Set the rinse aid dispenser to the lowest setting (**L1**) when using multi-product detergents that have a rinse aid component added to the detergent.

Cleaning

Outside

Occasionally wipe with a mild nonabrasive detergent and water. Rinse and dry.

Care of drain air gap

If a drain air gap was installed for your built-in dishwasher, check to make sure it is clean so the dishwasher will drain properly. A drain air gap is usually mounted on the counter top and can be inspected by removing the cover. This is not part of your dishwasher and is not covered by warranty.

Clean the cylinder fine filter

The Cylinder Fine Filter is designed to collect some big items such as broken glass, bones and pits. The Cylinder Fine Filter needs to be cleaned to maximize wash performance.

Remove the Cylinder Fine Filter as shown:

To replace the fine filter, press down and rotate clockwise until the arrows are aligned. A mechanical click will indicate that the filter is firmly in place.

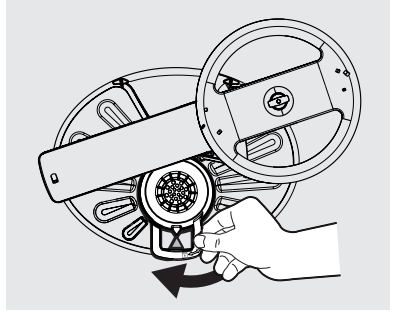

Clean the coarse filter

Take out the Cylinder Fine Filter and remove the Coarse Filter from the dishwasher tub bottom. Flush the Coarse Filter by holding it under running water and replace.

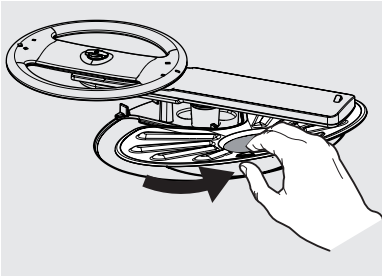

1. Rotate it counterclockwise.

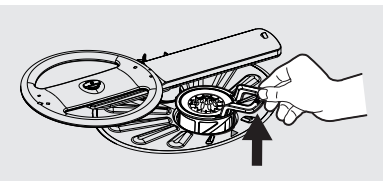
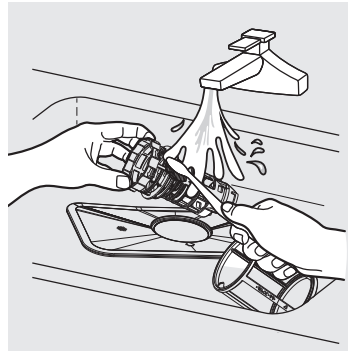

2. Lift it out and empty the contents.
3. Clean the filter by rinsing under running water and replace. It may be necessary to use a sponge or bottle brush to remove excess food residue.

20 CARE AND CLEANING

Winterizing

A dishwasher left in an unheated place should be protected from freezing. Have a qualified person do the following.

To Disconnect Service:

1. Turn off electrical power to the dishwasher at the supply source by removing fuses or tripping circuit breaker.
2. Shut off water supply.
3. Place a pan under the inlet valve. Disconnect water line from the inlet valve and drain into pan.
4. Disconnect drain line from pump and drain water into pan.

To Restore Service:

1. Reconnect the water, drain, and electrical power supply.
2. Turn on water and electrical power supply.
3. Fill detergent cup and run the dishwasher through a **HEAVY** wash cycle.
4. Check connections to make sure they do not leak.



CAUTION

Freezing temperatures may cause water lines to rupture. Be sure all supply lines to and circulating lines within your dishwasher are protected. Failure to do so could result in property damage.



NOTE

If the dishwasher door is opened while the unit is running, the **START/CANCEL** button must be pressed and the door shut immediately to return the unit to the selected cycle and option. This must happen within 10 minutes for the unit to continue the cycle.

Removing spots and film

Hard water can cause lime deposit buildup on the interior of the dishwasher. Dishes and glasses may also get spots and film for a number of reasons. (See **Glassware/Flatware Spotted or Cloudy** section). To remove buildup, and film, clean using the following instructions:

1. Load clean dishes and glasses in normal manner. Do not load any metal utensils or silverware.
2. Do not add detergent.
3. Select the **NORMAL** cycle. Press **START**. Close and latch the door.
4. Allow dishwasher to run until it starts the second water fill (approximately 10 minutes).
5. Unlatch and open door and pour 2 cups of white vinegar into the bottom of dishwasher.
6. Press **START**. Close and latch door and allow cycle to finish.



NOTE

See Installation Instructions for more details.

Energy use

The yellow energy guide label that came on your unit tells how much energy it would use in one year and how it compares to others that are available. The energy is based on the **NORMAL** cycle response to tests that apply soils and dishware that simulate the average use. Eight place settings of dishware and some serving pieces are used during the test. The total energy is based on running the average number of cycles per year, applying typical soil levels to the dishware and half the time, selecting the option of using extra energy to more fully dry the dishware. Actual energy and water use will depend upon the cycle and options you select.

This unit uses an in-line water heating element that is located under the tub. There is no exposed heater that plasticware might come in contact with or that is accessible to touch. The heat is taken to the dishware through the heated water. For this reason, plastic dishware may be placed where it best fits in either the top or bottom rack. Temperatures are uniform throughout the dishwasher.

If the user prefers to save energy and dry the dishes by hand they select the **AIR DRY** option: If you prefer to spend slightly more energy to get the dishes drier select one of the heated dry options. In response the wash and rinse temperatures in the cycle will be increased.

This aids cleaning and also heats the dishwasher. When all standing water is removed in the final drain, the extra heat stored in the dishware acts to evaporate the remaining water.

In general, more energy is used when more water and heat are used in a cycle. Several cycles, such as the **NORMAL** cycle, change based on soil level, options selected, and ambient conditions. The **NORMAL** cycle is good for all around use. Other cycles are focused toward special use like the **HEAVY** cycle that is designed for heavily solid cookware.

DishSense™ technology

Your unit has DishSense™ Technology that works to sense how heavily soiled the dish load is so the cycle is automatically adjusted to the appropriate response. This helps to prevent energy waste. The sensor is calibrated at the end of each cycle, and assures a clean load.



NOTE

For the first cycle after power is applied (when first installed or after a power failure) the sensor will not be calibrated and so cannot determine the soil load. Therefore, the unit provides a response suitable for heavily soiled dishes on the first run after power is restored. Energy use during this first run may be higher than would be typical.

Normal operating sounds

Your dishwasher uses energy efficient motors for the wash and drain portions of the cycle you select. Each cycle has a series of water fills and drains for washing and rinsing dishes. As each cycle begins, you may or may not hear the drain motor. You may also hear the splashing of water as it enters the tub and the spray arms as they rotate and circulate water. The wash motor often pulsates throughout the cycle, which varies water pressure and optimizes performance.

Normal operating lights

Your dishwasher buttons light up when the cycle and option are selected. All cycle and option buttons have an LED that lights white when selected. Deselected buttons are turned off when the control lock is active.

Factors affecting performance

Water Pressure

The hot water line to dishwasher must provide water pressure between 20 and 120 psi.

Low water pressure may occur when laundry or showers are in operation. If you experience poor wash performance you may need to wait until water use is reduced before starting dishwasher.

Water temperature

Hot water is needed for best dish washing and drying results. Water entering dishwasher should be at least 120°F (49°C) to give satisfactory results.

To check water temperature entering dishwasher:

- Turn on hot water faucet nearest dishwasher for several minutes to clear cool water from pipes.
- Hold a candy or meat thermometer in the water stream to check the temperature.
- If temperature is below 120°F (49°C), have a qualified person raise the hot water heater thermostat setting.

NOTE

Before starting a cycle, run hot water to clear cool water from pipes.

Power Alert

The dishwasher stops temporarily if a period of abnormal voltage occurs while the dishwasher is running.

NOTE

A power abnormality is when the voltage is either too low or too high to properly run appliances or electronic devices. A power outage is when no power is available to run any electronic devices.

During this time the UI will display 2 dashes and a red “power” message with a lit START LED.



Once the voltage returns to normal, the dishwasher automatically resumes the wash cycle if the door has not been opened. If the door is opened during the abnormal power condition, press start and close the door within 4 second for the cycle to resume when power returns to normal.

The red power indicator in the status window turns off once power is returned to normal.

If power becomes abnormal during cycle selection, the START LED will go out and the status window displays the red “power” message and 2 dashes.

NOTE

The buttons on the control panel may be disabled when voltage is too low for the dishwasher to operate.

Resume the wash after power outage

When power is restored, the control panel lights up for 3 seconds while the dishwasher starts up. After start-up completes, the wash settings of where the cycle left off display on the control panel and status window. The red “power” message will display in the status window and the START LED blinks to indicate power was out. The control panel stays in this state until any button other than CANCEL is pressed. Pressing CANCEL will cancel the cycle.



To resume a wash cycle after a power outage, open the door to show where the wash settings left off. Press **START** to resume the wash cycle.

Touch any button except **START** or **CANCEL** to acknowledge a power alert without resuming a wash.

24 TROUBLESHOOTING

NOTE

The control panel will timeout in 4 seconds if the **START** button is not pressed after opening the door. The start button must be pressed to resume the wash if power is lost and then restored during a running cycle.

If a power outage occurs during a wash delay, the dishwasher restarts upon power restoration. When the restart is complete, upon opening the door, the remaining delay time countdown shows up in the status window.

If power is lost during cycle selection, once power is restored, the control panel lights up for 3 seconds while the dishwasher starts up. After start-up completes, cycle selections can then be made if the door is open.

Before You Call:

Before calling for service, review this list. It may save you both time and expense. This list includes common experiences that are not the result of defective workmanship or material in your dishwasher.

Food Soils Left on Dishes

- Choose another cycle for longer washing time.
- Check rack loading section for proper loading-avoid nesting items.
- Do not overload the dishwasher (See Preparing and Loading Dishes).
- Check to verify that the glass trap is maintained and installed properly (See Care and Cleaning). Home water pressure may be too low-should be 20 to 120 pounds per square inch (psi).
- Check incoming water temperature. It should be about 120°F (49°C). (See Factors Affecting Performance).
- Check water hardness. For extremely hard water, it may be necessary to install a water softener. (See Detergent Chart).
- Use Fresh Detergent.
- Make sure items are not blocking the spray arms, preventing them from rotating.

Dishes not Dry

- By selecting Heat Dry, High Temp Wash or Sanitize options this will improve drying.
- Make sure the rinse aid dispenser is filled.
- Increase the discharge setting of rinse aid. (See Rinse Aid).
- Check the incoming water temperature. Be sure it is at least 120°F (49°C).
- Check for proper loading-avoid nesting items.
- Plastic items may need to be towel dried.
- Cups with a concave bottom will collect water. Load them at the far left of the upper rack so they will be held in a tilted position.
- Containers, bowls, pots/pans, and any dishware with concave surfaces that can collect water should be placed in the rack facing or angled down so that water is able to drain even from the lowest point.

Drying Tip

- Select the Normal Wash and High Temp Wash pads along with a Rinse Aid agent for improved drying performance.

Glassware/Flatware Spotted or Cloudy

- Check water hardness. For extremely hard water, it may be necessary to install a water softener. (See Detergent Chart).
- Water temperature may be low. Avoid extremely low or high temperatures. (See Factors Affecting Performance).
- Avoid overloading and improper loading. (See Preparing and Loading Dishes).
- Use fresh detergent. Old detergent is ineffective.
- Make sure rinse aid dispenser is filled.
- Check to see that proper amount of detergent is being used for cycle selected. (See Detergent Dispenser).
- Home water pressure may be too low-it should be 20 to 120 pounds per square inch (psi).

Dishware Chipped

- Load with care and do not overload. (See Preparing and Loading Dishes).
- Place delicate items in top rack.
- Place glasses securely against pins and not over pins.
- Load items so they are secure and don't jar loose when moving racks in and out. Move racks in and out slowly.
- Make sure tall glasses and stemware will clear top of tub when rack is pushed in.
- Fine antique china and crystal should be hand-washed.

Dishware Stained or Discolored

- Tea and coffee can stain cups. Remove the stains by hand washing in a solution of 1/2 cup (120 ml) bleach and one quart (1L) of warm water. Rinse thoroughly.
- Iron deposits in water can cause a yellow or brown film. A special filter installed in the water supply line will correct this problem. (See Removing Spots and Film).
- Aluminum utensils can leave gray/black marks when they rub against other items. Load Properly.
- Certain high acid foods can cause discoloration of stainless steel and plastics if allowed to sit for a long period. Rinse by hand if not operating dishwasher at once.
- Mixing stainless steel and silver utensils in silverware basket can cause pitting of the stainless steel blades. Avoid mixing stainless steel and silver.

Etching

- Using too much detergent especially in soft or softened water causes damage that looks like a film but cannot be removed.
- Adjust the amount of detergent based on the water hardness. (Check Detergent Chart).
- Lower the water temperature by selecting the Normal Cycle.

Dishwasher Won't Fill

- Assure the water supply is turned on.
- Check that the overflow protector moves up and down freely. (See Overflow Protector section).

Detergent Left in Cups

- Detergent may be old. Discard and use fresh detergent.
- Be sure the dish load doesn't spray from entering the detergent cup.
- Check to see if cycle has been completed.
- Make sure items do not prevent the detergent dispenser from opening.

Vapor at Vent

- Water vapor escapes from the vent during the drying part of cycle. This is normal.
- Spilled rinse aid can cause foam and lead to overflowing. Wipe up any spills with a damp cloth.
- Check to see that dishwasher is level. (See Installation Instructions).

Normal Sounds You Will Hear

- Normal sounds include water fill, water circulation and motor sounds.
- There is a noticeable change in sound when the wash action switches between the lower and middle spray arm. This is normal since each spray arm has its own sound.
- It is normal for the dishwasher to pause (no sound) when the wash action is switching between the lower and middle spray arms.

Water in Bottom of Tub

- Water left in the tub bottom after the cycle is complete is not normal. If water remains in the bottom of the tub, the dishwasher may not be draining properly. (See Dishwasher Does not Drain Properly).

Dishwasher Leaks

- Check that the door gasket is pressed into its mounting channel, reaches to the bottom of the tub and does not extend beyond the end rib so as to interfere with door closure.
- Spilled rinse aid can cause foam and lead to overflowing. Wipe up any spills with a damp cloth.

26 TROUBLESHOOTING

- Check to see that the dishwasher is level. (See Installation Instructions).
- Avoid oversudsing by using the correct amount of detergent designed for automatic dishwashers.

Dishwasher Won't Run

- Check to see if circuit breaker is tripped or if a fuse is blown.
- Make sure water supply is turned on.
- Check to see if cycle is set correctly. (See Operating Instructions).
- Is dishwasher set for Delay Start Option?
- Make sure door is closed and latched.
- Make sure START/CANCEL pad is pressed after the cycle has been selected.

Dishwasher Does Not Drain Properly

- If unit is hooked up to a food waste disposer, make sure the disposer is empty.
- Assure the knockout plug has been removed from inside the food waste disposer inlet.
- Assure the drain hose isn't kinked.
- Make sure cycle is complete, not in a pause.
- Assure the glass trap is maintained and installed properly assuring no clogs (**See Care and Cleaning**).

Cycle Takes a Long Time

- The cycle may have been automatically lengthened to reach key temperatures due to some factor such as a cool water supply or a large load of dishes.
- Delay Start option may have been selected.
- Choose lower temperature options to shorten the cycle.
- Cycles that are soil-sensing adjust automatically to assure a good wash - heavier soils will elicit a longer cycle response.

Dishwasher has an Odor

- Soiled dishes left in dishwasher too long can create an odor.

- There will be a "new" smell when first installed. This is normal.
- Check to see if unit is draining properly. (See Dishwasher Does Not Drain Properly).

Stains on Tub Interior

- Washing large amounts of dishware with tomato based soil can cause a pink/orange appearance. This will not affect performance and will gradually fade over time. Pre-rinsing will reduce the chance of staining. Using no heat dry option will lessen staining.

Opening the door during cycle

- If the dishwasher door is opened while the unit is running, the START/CANCEL pad must be pressed and the door shut immediately to return the unit to the selected cycle and option, this must happen within 10 minutes for the unit to continue the cycle.

Removing Spots and Film

Hard water can cause lime deposit buildup on the interior of the dishwasher. Dishes and glasses may also get spots and film for a number of reasons. (See Glassware/Flatware Spotted or Cloudy section). To remove buildup, and film, clean using the following instructions:

1. Load clean dishes and glasses in normal manner. Do not load any metal utensils or silverware.
2. Do not add detergent.
3. Select the Normal Wash cycle. Close and latch door. Press START/CANCEL pad.
4. Allow dishwasher to run until it starts the second water fill (approximately 10 minutes).
5. Unlatch and open door and pour 2 cups of white vinegar into the bottom of dishwasher.
6. Close and latch door and allow cycle to finish.

Your appliance is covered by a one year limited warranty. For one year from your original date of purchase, Electrolux will pay all costs for repairing or replacing any parts of this appliance that prove to be defective in materials or workmanship when such appliance is installed, used and maintained in accordance with the provided instructions.

Exclusions

This warranty does not cover the following:

1. Products with original serial numbers that have been removed, altered or cannot be readily determined.
2. Product that has been transferred from its original owner to another party or removed outside the USA or Canada.
3. Rust on the interior or exterior of the unit.
4. Products purchased "as-is" are not covered by this warranty.
5. Food loss due to any refrigerator or freezer failures.
6. Products used in a commercial setting.
7. Service calls which do not involve malfunction or defects in materials or workmanship, or for appliances not in ordinary household use or used other than in accordance with the provided instructions.
8. Service calls to correct the installation of your appliance or to instruct you how to use your appliance.
9. Expenses for making the appliance accessible for servicing, such as removal of trim, cupboards, shelves, etc., which are not a part of the appliance when it is shipped from the factory.
10. Service calls to repair or replace appliance light bulbs, air filters, water filters, other consumables, or knobs, handles, or other cosmetic parts.
11. Surcharges including, but not limited to, any after hour, weekend, or holiday service calls, tolls, ferry trip charges, or mileage expense for service calls to remote areas, including the state of Alaska.
12. Damages to the finish of appliance or home incurred during installation, including but not limited to floors, cabinets, walls, etc.
13. Damages caused by: services performed by unauthorized service companies; use of parts other than genuine Electrolux parts or parts obtained from persons other than authorized service companies; or external causes such as abuse, misuse, inadequate power supply, accidents, fires, or acts of God.

DISCLAIMER OF IMPLIED WARRANTIES; LIMITATION OF REMEDIES

CUSTOMER'S SOLE AND EXCLUSIVE REMEDY UNDER THIS LIMITED WARRANTY SHALL BE PRODUCT REPAIR OR REPLACEMENT AS PROVIDED HEREIN. CLAIMS BASED ON IMPLIED WARRANTIES, INCLUDING WARRANTIES OF MERCHANTABILITY OR FITNESS FOR A PARTICULAR PURPOSE, ARE LIMITED TO ONE YEAR OR THE SHORTEST PERIOD ALLOWED BY LAW, BUT NOT LESS THAN ONE YEAR. ELECTROLUX SHALL NOT BE LIABLE FOR CONSEQUENTIAL OR INCIDENTAL DAMAGES SUCH AS PROPERTY DAMAGE AND INCIDENTAL EXPENSES RESULTING FROM ANY BREACH OF THIS WRITTEN LIMITED WARRANTY OR ANY IMPLIED WARRANTY. SOME STATES AND PROVINCES DO NOT ALLOW THE EXCLUSION OR LIMITATION OF INCIDENTAL OR CONSEQUENTIAL DAMAGES, OR LIMITATIONS ON THE DURATION OF IMPLIED WARRANTIES, SO THESE LIMITATIONS OR EXCLUSIONS MAY NOT APPLY TO YOU. THIS WRITTEN WARRANTY GIVES YOU SPECIFIC LEGAL RIGHTS. YOU MAY ALSO HAVE OTHER RIGHTS THAT VARY FROM STATE TO STATE.

If You Need Service

Keep your receipt, delivery slip, or some other appropriate payment record to establish the warranty period should service be required. If service is performed, it is in your best interest to obtain and keep all receipts. Service under this warranty must be obtained by contacting Electrolux at the addresses or phone numbers below.

This warranty only applies in the USA and Canada. In the USA, your appliance is warranted by Electrolux Major Appliances North America, a division of Electrolux Home Products, Inc. In Canada, your appliance is warranted by Electrolux Canada Corp. Electrolux authorizes no person to change or add to any obligations under this warranty. Obligations for service and parts under this warranty must be performed by Electrolux or an authorized service company. Product features or specifications as described or illustrated are subject to change without notice.

USA
1-800-374-4432
Frigidaire
10200 David Taylor Drive
Charlotte, NC 28262



Electrolux

Canada
1.800.265.8352
Electrolux Canada Corp.
5855 Terry Fox Way
Mississauga, Ontario, Canada
L5V 3E4

FRIGIDAIRE®

welcome **home.**

Our home is your home. Visit us if you need help with any of these things:



owner support



accessories



service



registration

(See your registration card for more information.)

Frigidaire.com
1-800-374-4432

Frigidaire.ca
1-800-265-8352