

FRIGIDAIRE

All about the

Use & Care

of your Gas Range

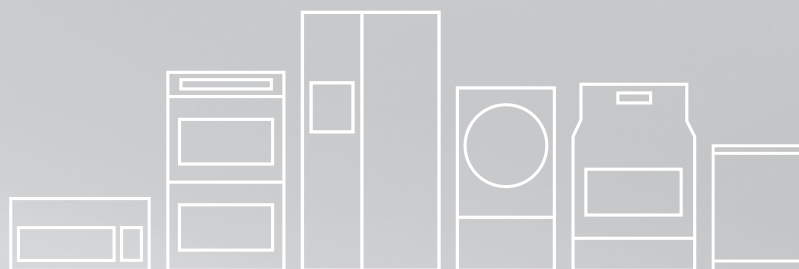

TABLE OF CONTENTS

Product Record and Registration	2	Setting Oven Controls	20
Important Safety Instructions	3	Care and Cleaning	33
Cooking Recommendations	10	Before You Call	38
Before Setting Surface Controls	13	Warranty	43
Setting Surface Controls	16		
Before Setting Oven Controls	19		

PRODUCT RECORD AND REGISTRATION

Product Registration	2
Product Record and Registration	2
Need Help?	2
Important Safety Instructions	3
Cooking Recommendations	10
Before Setting Surface Controls	13
Setting Surface Controls	16
Before Setting Oven Controls	19
Setting Oven Controls	20
Care and Cleaning	33
Oven Baking	38
Before You Call	38
Warranty	43

Questions?

For toll-free telephone support in the U.S. and Canada call **1-800-944-9044 (is Canada just for Electrolux?)**

For online support and Internet production information visit <http://www.frigidaire.com>.

Product Registration

Registering your product with Frigidaire enhances our ability to serve you. You can register online at <http://www.frigidaire.com> or by dropping your Product Registration Card in the mail.

Record model & serial numbers here

Purchase Date

Frigidaire model number

Frigidaire serial number

Serial Plate Location

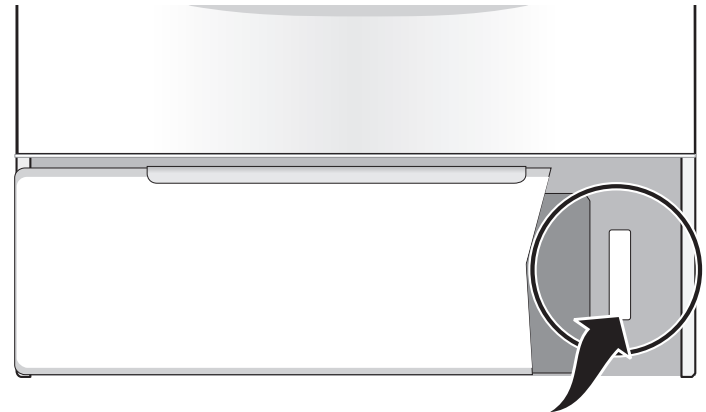

Serial plate location: open lower oven drawer (some models) or storage drawer (some models).

Thank you for choosing Frigidaire.

Important: This Use and Care Guide is part of our commitment to customer satisfaction and product quality throughout the service life of your new appliance. We view your purchase as the beginning of a relationship. To ensure our ability to continue serving you, please use this page to record important product information.

Need Help?

Visit the Frigidaire web site at www.frigidaire.com

Before you call for service, there are a few things you can do to help us serve you better.

Read this Use & Care Manual

This manual contains instructions to help you use and maintain your range properly.

If You Received a Damaged Range...

Immediately contact the dealer (or builder) that sold you the range.

Save Time and Money

Check the section title "Before You Call". This section helps step you through some common problems that might occur.

If you do need service, help is only a phone call away. Call Frigidaire Customer Services at **1-800-944-9044**.

IMPORTANT SAFETY INSTRUCTIONS

Read all instructions before using this appliance.

This manual contains important safety symbols and instructions. Please pay attention to these symbols and follow all instructions given.

Do not attempt to install or operate your appliance until you have read the safety precautions in this manual. Safety items throughout this manual are labeled with a **WARNING** or **CAUTION** statement based on the risk type.

Warnings and important instructions appearing in this guide are not meant to cover all possible conditions and situations that may occur. Common sense, caution, and care must be exercised with installing, maintaining, or operating your appliance.

DEFINITION

 This is the safety alert symbol. It is used to alert you to potential personal injury hazards. Obey all safety messages that follow this symbol to avoid possible injury or death.

WARNING

Indicates a potentially hazardous situation which, if not avoided, may result in death or serious injury.

CAUTION

Indicates a potentially hazardous situation which, if not avoided, may result in minor or moderate injury.

IMPORTANT

Indicates installation, operation, maintenance, or valuable information that is not hazard related.

NOTE

Indicates a short, informal reference – something written down to assist the memory or for future reference.

 **WARNING** If the information in this manual is not followed exactly, a fire or explosion may result causing property damage, personal injury or death.

FOR YOUR SAFETY: Do not store or use gasoline or other flammable vapors and liquids in the vicinity of this or any other appliance.

WHAT TO DO IF YOU SMELL GAS:

- Do not try to light any appliance.
- Do not touch any electrical switch; do not use any phone in your building.
- Immediately call your gas supplier from a neighbor's phone. Follow the gas supplier's instructions.
- If you cannot reach your gas supplier, call the fire department.
- Installation and service must be performed by a qualified installer, servicer, or the gas supplier.

IMPORTANT SAFETY INSTRUCTIONS



WARNING

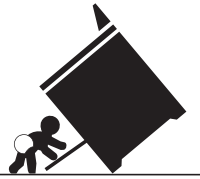

Tip Over Hazard

- A child or adult can tip the range and be killed.
- Verify the anti-tip device has been installed to floor or wall.

- Ensure the anti-tip device is re-engaged to floor or wall when the range is moved.
- Do not operate the range without the anti-tip device in place and engaged.
- Failure to follow these instructions can result in death or serious burns to children and adults.

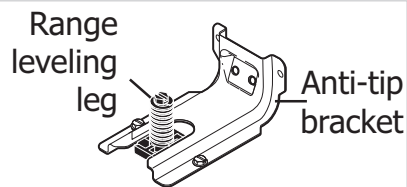

To check if the anti-tip bracket is installed properly, use both arms to grasp the rear edge of the range back. Carefully attempt to tilt range forward. When properly installed, the range should not tilt forward.

Refer to the anti-tip bracket installation instructions supplied with your range for proper installation.

IMPORTANT INSTRUCTIONS FOR UNPACKING AND INSTALLATION

IMPORTANT - Read and follow the below instructions and precautions for unpacking, installing, and servicing your appliance:

Remove all tape and packaging before using the appliance. Destroy the carton and plastic bags after unpacking the appliance. Never allow children to play with packaging material. Do not remove the wiring label and other literature attached to the appliance. Do not remove model/serial number plate.

Cold temperatures can damage the electronic control. When using this appliance for the first time, or when the appliance has not been used for an extended period of time, be sure the appliance has been in temperatures above 32°F (0°C) for at least 3 hours before turning on the power to the appliance.

Never modify or alter the construction of the appliance by removing the leveling legs, panels, wire covers, anti-tip brackets/screws, or any other part of the appliance.

Be sure to have an appropriate foam-type fire extinguisher available, visible, and easily accessible located near the appliance.



WARNING

Air curtain or other overhead range hoods which operate that operate by blowing a downward air flow onto a range or cooktop, shall not be used in conjunction with gas ranges or cooktops other than when the range or cooktop and hood have been designed, tested, and listed by an independent test laboratory for use in combination with each other.

IMPORTANT SAFETY INSTRUCTIONS

GROUNDING INSTRUCTIONS

⚠ WARNING

Avoid fire hazard or electrical shock. Failure to follow this warning may cause serious injury, fire, or death.

Avoid fire hazard or electrical shock. Do not use an adapter plug, use an extension cord, or remove grounding prong from the power cord. Failure to follow this warning may cause serious injury, fire, or death.

Proper Installation—Be sure your appliance is properly installed and grounded by a qualified technician. In the United States, install in accordance with the National Fuel Gas Code ANSI Z223.1/NPFA No. 54, latest edition and National Electrical Code NFPA No. 70 latest edition, and local electrical code requirements. In Canada, install in accordance with CAN/CGA B149.1 and CAN/CGA B149.2 and CSA Standard C22.1, Canadian Electrical code, Part 1-latest editions and local electrical code requirements. Install only per installation instructions provided in the literature package for this appliance.

For personal safety, this appliance must be properly grounded. For maximum safety, the power cord must be securely connected to an electrical outlet or junction box that is the correct voltage, is correctly polarized and properly grounded, and protected by a circuit breaker in accordance with local codes.

It is the personal responsibility of the consumer to have the appropriate outlet or junction box with the correct, properly grounded wall receptacle installed by a qualified electrician. It is the responsibility and obligation of the consumer to contact a qualified installer to assure that the electrical installation is adequate and is in conformance with all local codes and ordinances.

This appliance is equipped with a 3-prong grounding plug for your protection against shock hazard and should be plugged directly into a properly grounded receptacle. Do not cut or remove the grounding prong from this plug.

For personal safety, the appliance must be properly grounded. For maximum safety, the power cord must be plugged into an electrical outlet that is correctly polarized and properly grounded.

If a 2-prong wall receptacle is the only available outlet, it is the personal responsibility of the consumer to have it replaced with a properly grounded 3-prong wall receptacle, installed by a qualified technician.

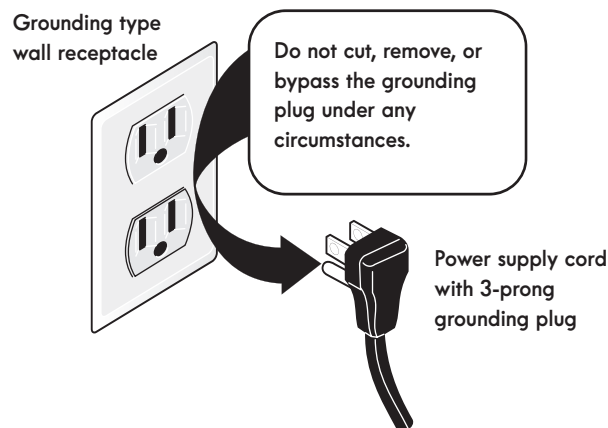

Conversion to (L.P.) Gas

This appliance allows for conversion to Liquefied Petroleum (L.P.) Gas.

⚠ WARNING

Personal injury or death from electrical shock may occur if the conversion to L.P. gas is not made by a qualified installer or electrician. Any additions, changes or conversions required in order for this appliance to satisfactorily meet the application needs must be made by a qualified technician.

If L.P. conversion is needed, contact your local L.P. Gas provider for assistance.

IMPORTANT SAFETY INSTRUCTIONS

See the installation instructions packaged with this appliance for complete installation and grounding instructions.

IMPORTANT INSTRUCTIONS FOR USING THE APPLIANCE

WARNING

Storage In or On Appliance—Flammable materials should not be stored in an oven or microwave, near surface burners or elements, or in the storage or warmer drawer (if equipped). This includes paper, plastic, and cloth items, such as cookbooks, plastic ware, and towels, as well as flammable liquids. Do not store explosives, such as aerosol cans, on or near the appliance.

Do not leave children alone - Children should not be left alone or unattended in the area where appliance is in use. They should never be allowed to sit or stand on any part of the appliance, including the storage drawer, lower broiler drawer, warmer drawer, or lower double oven.

Do not store items of interest to children in the cabinets above the appliance or on the back-guards of ranges. Children climbing on or near the appliance to reach items could be seriously injured.

Do not allow children to climb or play around the appliance. The weight of a child on an open over door may cause the appliance to tip, resulting in serious burns or other injury. An open drawer when hot may cause burns.

Stepping, leaning, or sitting on the door or drawers of this appliance can result in serious injuries and also cause damage to the appliance.

WARNING

Never cover any slots, holes, or passages in the oven bottom or cover an entire oven rack with any materials, such as aluminum foil or after-market oven liners. Aluminum foil and other liners may trap heat, causing a fire hazard.

Do not use oven or warmer drawer (if equipped) for storage.

Never use your appliance as a space heater to heat or warm the room. Doing so may result in carbon monoxide poisoning and overheating of the appliance.

CAUTION

When heating fat or grease, watch it closely. Grease may catch fire if it becomes too hot.

Do not use water or flour on grease fires. Smother fire or flame or use dry chemical or foam-type extinguisher. Cover the fire with a pan lid or use baking soda.

Use dry potholders. Moist or damp potholders on hot surfaces may result in burns from steam. Do not let potholders touch hot cooking areas. Do not use towels or other bulky cloths.

Do not heat unopened food containers - Build-up of pressure may cause container to burst and result in injury.

Wear proper apparel - Loose-fitting or hanging garments should never be worn while using the appliance. Do not let clothing or other flammable materials contact hot surfaces.

IMPORTANT SAFETY INSTRUCTIONS

CAUTION

Do not touch surface burners or elements, areas near these burners or elements, interior surfaces of the oven, or the warmer drawer (if equipped). Surface burners and elements may be hot even though they appear cool. Areas near surface burners and elements may become hot enough to cause burns. During and after use, do not touch, or let clothing or other flammable materials touch these areas until they are cool. These areas may include the cooktop, surfaces facing the cooktop, oven vent areas, oven door, and oven window.

Do not attempt to operate the appliance during a power failure. If the power fails, always turn off the appliance. If the appliance is not turned off and the power resumes, electric surface elements may resume operation when power is restored. Once the power resumes, reset the clock and the oven function.

IMPORTANT INSTRUCTIONS FOR USING YOUR GAS COOKTOP

CAUTION

Use Proper Flame Size — Adjust flame size so it does not extend beyond the edge of the utensil. The use of undersized utensils will expose a portion of the burner flame to direct contact and may result in ignition of clothing. Proper relationship of utensil to flame will also improve efficiency.

Know which knob or key controls each surface heating area. Place cookware with food on the cooking area before turning it on. Turn the cooking area off before removing the cookware.

Use proper pan size. This appliance is equipped with one or more surface units of different sizes.

Select cookware with flat bottoms that match the surface unit heating element. The use of undersized cookware may expose a portion of the flame to direct contact and may result in the ignition of clothing or other items. Using the proper cookware on the cooking areas will improve efficiency.

Always turn knob to the full LITE position when igniting top burners. Visually check that burner has lit. Then adjust the flame so it does not extend beyond the edge of the utensil.

To reduce the risk of burns, ignition of flammable materials, and spillage due to unintentional contact with the utensil, the handle of the utensil should be positioned so that it is turned inward, and does not extend over adjacent surface burners.

Never leave surface burners unattended at high heat settings — Boil overs cause smoking and greasy spill overs that may ignite, or a pan that has boiled dry may melt.

Glazed cooking utensils — Only certain types of glass, glass/ceramic, ceramic, earthenware, or other glazed utensils are suitable for cook top service without breaking due to the sudden change in temperature. Check the manufacturer's recommendations for cook top use.

When you are flaming foods under a ventilating hood, turn the fan on.

IMPORTANT INSTRUCTIONS FOR USING YOUR OVEN

Protective liners—Do not use aluminum foil, aftermarket oven liners, or any other materials or devices to line oven bottom, oven racks, or any other part of the appliance. Only use aluminum as recommended for baking, such as lining cookware or as a cover placed on food. Any other use of protective liners or aluminum foil may result in a risk of electric shock or fire or a short circuit.

IMPORTANT SAFETY INSTRUCTIONS

Use care when opening oven door, lower oven door, or warmer drawer (some models). Stand to the side of the appliance when opening the door of a hot oven. Let hot air or steam escape before you remove or replace food in the oven.

Keep oven vent ducts unobstructed. Touching surfaces in this area when the oven is on may cause severe burns. Do not place plastic or heat-sensitive items on or near the oven vent. These items can melt or ignite.

Placement of oven racks - Always place oven racks in desired location while oven is cool. If rack must be moved while oven is hot, do not let potholder contact hot burner or element in oven. Use potholders and grasp the rack with both hands to reposition. Remove all cookware and utensils before moving the rack.

Do not use a broiler pan without its insert. Broiler pans and inserts allow dripping fat to drain away from the high heat of the broiler. Do not cover the broiler insert with aluminum foil; exposed fat and grease could ignite.

Do not cook food on the oven bottom. Always cook in proper cookware and always use the oven racks.

IMPORTANT INSTRUCTIONS FOR CLEANING YOUR APPLIANCE

CAUTION

Before manually cleaning any part of the appliance, be sure all controls are turned off and the appliance is cool. Cleaning a hot appliance can cause burns.

Clean the appliance regularly to keep all parts free of grease that could catch fire. Do not allow grease to accumulate. Greasy deposits in the fan could catch fire.

Always follow the manufacturer's recommended directions for use of kitchen cleaners and aerosols. Be aware that excess residue from cleaners and aerosols may ignite causing damage and injury.

Clean ventilating hoods frequently - Grease should not be allowed to accumulate on hood or filter. Follow the manufacturer's instructions for cleaning vent hoods.

IMPORTANT INSTRUCTIONS FOR SELF CLEANING OVENS

Do not clean the oven door gasket. The door gasket is essential for a good seal. Care should be taken not to rub, damage, or move the gasket.

Do not use oven cleaners. No commercial oven cleaner or oven liner protective coating of any kind should be used in or around any part of the appliance.

Use the self clean cycle to clean only the parts listed in this manual.

Before using self clean, remove the broiler pan, any food, utensils, and cookware from the oven, storage drawer or warming drawer (if equipped). Remove oven racks unless otherwise instructed.

Some birds are extremely sensitive to the fumes given off during the self clean cycle of any oven. Move birds to another well-ventilated room.

IMPORTANT SAFETY INSTRUCTIONS

IMPORTANT INSTRUCTIONS FOR SERVICE AND MAINTENANCE

Do not repair or replace any part of the appliance unless specifically recommended in the manuals. All other servicing should be done only by a qualified technician. This reduces the risk of personal injury and damage to the appliance.

Always contact your dealer, distributor, service agent, or manufacturer about problems or conditions you do not understand.

Ask your dealer to recommend a qualified technician and an authorized repair service. Know how to disconnect the power to the appliance at the circuit breaker or fuse box in case of an emergency.

Remove the oven door from any unused oven if it is to be stored or discarded.

Do not touch a hot oven light bulb with a damp cloth. Doing so could cause the bulb to break. Handle halogen lights (if equipped) with paper towels or soft gloves. Disconnect the appliance or shut off the power to the appliance before removing and replacing the bulb.

Important Safety Notice - The California Safe Drinking Water and Toxic Enforcement Act requires the governor of California to publish a list of substances known to cause cancer, birth defects, or other reproductive harms, and requires businesses to warn customers of potential exposures to such substances.

COOKING RECOMMENDATIONS

Bakeware

The material of bakeware affects how evenly and quickly it transfers heat from the pan to the food.

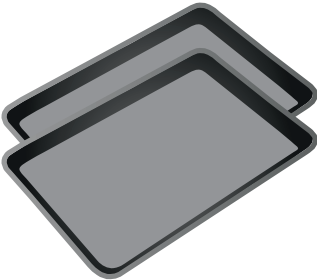
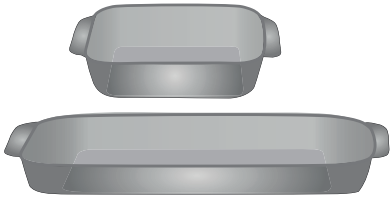
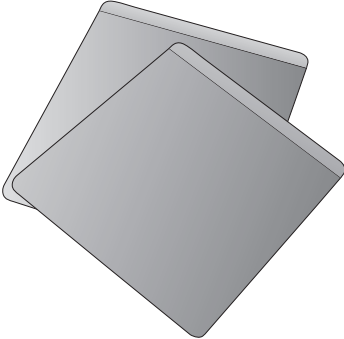
Material	Attributes	Recommendation
Shiny metal bakeware 	Shiny, aluminum, and non-coated bakeware is the best for even heating. It is suitable for all baked goods.	Recommended cooking temperatures and times are based on shiny metal bakeware.
Dark metal bakeware 	Dark bakeware cooks hotter than shiny bakeware.	Reduce the cooking temperature by 25° F (13-14° C) when using dark bakeware.
Glass bakeware 	Glass bakeware cooks hotter than shiny bakeware. Glass is convenient, as the same piece of bakeware can be used for cooking, serving, and storing food.	Reduce the cooking temperature by 25° F (13-14° C) when using glass bakeware.
Insulated bakeware 	Insulated bakeware cooks cooler than shiny bakeware. Insulated bakeware is designed for baking in gas ovens.	Increase the cooking temperature by 25° F (13-14° C) when using insulated bakeware.

COOKING RECOMMENDATIONS

Cooking Conditions

Conditions in your kitchen can affect the performance of your appliance when cooking food.

Condition	Attributes	Recommendation
Aging cookware	As pans age and become discolored, cooking times may need to be reduced slightly.	If food is too dark or overcooked, use the minimum cook time in the recipe or packaging. If food is too light or undercooked, use the middle to maximum cook time in the recipe or packaging.
High altitude	Air is drier and air pressure is lower. Water boils at a lower temperature, and liquids evaporate faster. Foods may take longer to bake. Doughs may rise faster.	Adjust cooking temperature, cooking time, or recipes as needed. Increase amount of liquid in baking recipes. Increase cook time on cooktop. Cover dishes to reduce evaporation. Increase bake time or oven temperature. Reduce amount of baking soda or baking powder in recipe. Reduce rising time or punch down dough and allow it to rise twice.

Cooking Results

Small adjustments may fix a problem with food not being as done as you like or more done than you like.

Result	Recommendation
Food too light	Use the middle to maximum cook time recommended on packaging or recipe.
Food too dark	Use the minimum cook time recommended on packaging or recipe.

Cooking Tips

Use these additional tips to get the best results from your appliance.

Cooking	Tips
Baking	
Rack placement	Follow the instructions in “Setting Oven Controls” on starting on page 20 . When using only one rack, place the rack so the food is in the center of the oven.
Preheat	Fully preheat the oven before baking items like cookies, cakes, biscuits and breads. Insert food immediately after the beep.
Checking food	Use the window and oven light when checking food. Opening the door may reduce baking performance.

COOKING RECOMMENDATIONS

Cooking	Tips
Bake or Convection Bake	Convection bake is the best function to use for baking on multiple racks. For best performance, see “Quick Bake (Model B)” on page 25.
Food placement	Allow at least 2 inches (5 cm) of space between bakeware for proper air circulation.
Broiling / Roasting	
Broiling pan	<p>For best results when broiling, use a broil pan with a broil pan insert designed to drain the fat from the food, help avoid spatter, and reduce smoking. The broiler pan will catch grease spills, and the insert helps prevent grease splatters.</p> <p>If a broiler pan and insert are not supplied with this appliance, they may be purchased from Frigidaire.com.</p>
Convection Cooking	
Convection attributes	<p>Convection cooking uses a fan to circulate hot air around the oven and food. It browns food more evenly and reduces hot spots in the oven.</p> <p>Convection saves time when using multiple racks or cooking several food items at once.</p>
Convection bake	<p>Reduce cooking temperature by 25° F (13-14° C) from the recipe unless the recipe is written for convection baking.</p> <p>Preheat the oven for best results.</p>
Convection roast	<p>Convection roast is best for meats and does not require preheating for most meats and poultry.</p> <p>Reducing the cooking temperature for convection roast is not recommended. Carefully follow your recipe's temperature and time recommendations, adjusting the cooking time if the recipe does not specify convection roasting time.</p> <p>Since convection roast cooks faster, cook time may be reduced by 25% to 40% depending on food type. You can reduce cook times by 25% from the recommended time of your recipe, and check the food at this time. If needed, continue cooking until the desired doneness is obtained.</p> <p>Use a meat probe if available with your appliance. Meat probes are also available from most grocery and home goods stores.</p> <p>Arrange oven racks so large cuts of meat and poultry are on the lowest rack of the oven.</p> <p>Do not cover foods when dry roasting - covering will prevent the meat from browning properly.</p> <p>When cooking meats, use the broiler pan and insert or a roasting rack. The broiler pan will catch grease spills and the insert helps prevent grease splatters. If you do not have one of these accessories, they may be purchased from Frigidaire.com.</p>

BEFORE SETTING SURFACE CONTROLS

Assembly of the burner caps

Make sure that all of the surface burner caps and surface burner grates are installed correctly and at the correct locations.

1. Remove all packing material from the cooktop area.
2. Make sure burner caps are properly placed on the surface burners.
3. Unpack the burner grates and position them on the cooktop.
4. Discard all packing material.

On round-style burners, the burner cap lip (Figure 1) should fit snug into the center of the burner head and rest level. Refer to Figure 2 for correct and incorrect burner cap placement.

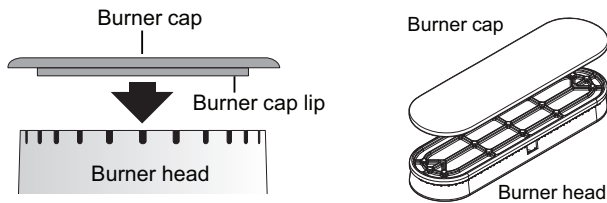

Figure 1: Burner caps and burner heads

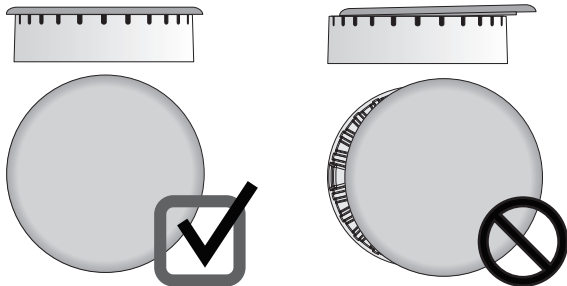

Figure 2: Proper burner cap placement

Once in place, you may check the fit by gently sliding the burner cap from side to side (Figure 3) to be sure it is centered and firmly seated. When the burner cap lip makes contact inside the center of the burner head you will be able to hear the burner cap click.

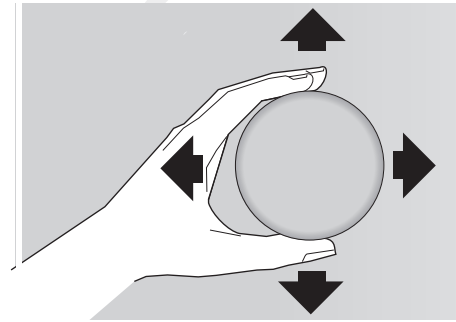

Figure 3: Gently move cap for proper placement

IMPORTANT

Please note that the burner cap should not move off the center of the burner head when sliding from side to side.

- Check and be sure that all oval-style burner caps (some models) are correctly in place on oval burner heads.
- Do not use the surface burners without the burner caps properly installed. Improperly seated burner caps may prevent burners from lighting or cause uneven flame and heating.
- Missing pieces or improper installation may lead to spills, burns, or damage to your range and cookware.
- Never place flammable items on the cooktop.

CAUTION

- Do not allow spills, food, cleaning agents, or any other material to enter the gas orifice holder opening.
- Always keep the burner caps and burner heads in place whenever the surface burners are in use.
- Never place flammable items on the cooktop.

BEFORE SETTING SURFACE CONTROLS

Install burner grates

To install burner grates, place the grates flat-side down and align them into the cooktop recess.

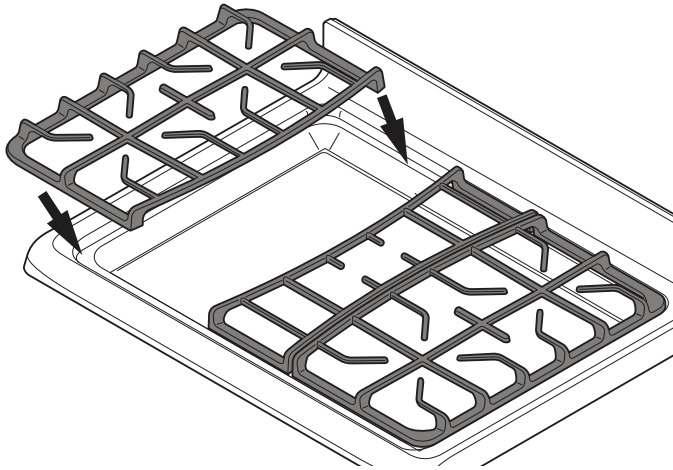
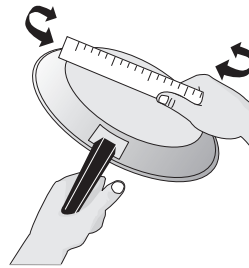

Figure 4: Proper grate installation

IMPORTANT

- Make sure the burner grates are properly placed on the cooktop before using the surface burners (Figure 4). The grates are designed to rest inside the recess on the cooktop.
- Grates should rest flush against each other and against the sides of the recess.
- Do not line the area underneath the grates or any part of the cooktop with aluminum foil or with any other lining.

Using Proper Cookware



The size and type of cookware used will influence the heat setting needed for best cooking results. Be sure to follow the recommendations for using proper cookware as illustrated in Figure 5 and Figure 6.

Figure 5: Testing cookware

Check for flatness by rotating a ruler across the bottom of the cookware (See Figure 5). Cookware should have flat bottoms that make good contact with the entire surface heating element (See Figure 6).

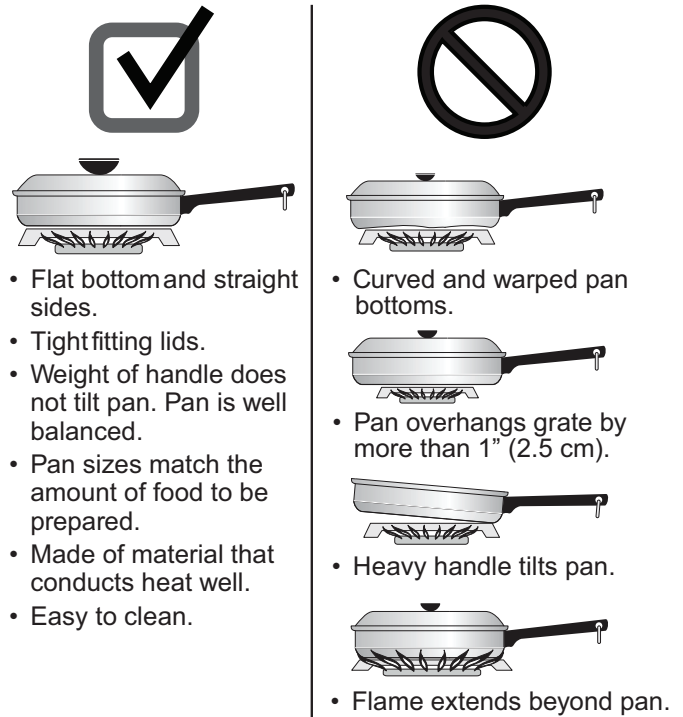

Figure 6: Proper cookware

BEFORE SETTING SURFACE CONTROLS

Cookware Material Types

The cookware material determines how evenly and quickly heat is transferred from the surface burner to the pan bottom. The most popular materials available are:

- **Aluminum** - Excellent heat conductor. Some types of food will cause it to darken (Anodized aluminum cookware resists staining and pitting).
- **Copper** - Excellent heat conductor but discolors easily (See Aluminum).
- **Stainless** - Slow heat conductor with uneven cooking results. Is durable, easy to clean and resists staining.
- **Cast Iron** - A slow heat conductor that retains heat very well. Cooks evenly once cooking temperature is reached.
- **Porcelain-enamel on metal** - Heating characteristics will vary depending on base material.
- **Glass** - Slow heat conductor.

Gas surface burner types

The cooktop is equipped with gas surface burners with different BTU ratings. The ability to heat food quickly and in large amounts increases as the burner size increases.

- Small burners are best used for low-flame heating of small amounts of food.
- Standard burners can be used for most surface cooking needs.
- The largest burner is best used for bringing large quantities of liquid rapidly up to temperature or when preparing larger quantities of food. The large burner is located at the right front position on the cooktop.

Regardless of size, always select cookware that is suitable for the amount and type of food being prepared. Select a burner and set the flame size appropriately for the pan. Never allow flames to extend beyond the outer edge of the pan.

CAUTION

Do not place flammable items such as plastic salt and pepper shakers, spoon holders, or plastic wrappings on the cooktop when it is in use. These items could melt or ignite. Potholders, towels or wooden spoons could catch fire if placed too close to the range cooktop.

IMPORTANT

Do not place aluminum foil, or ANY material that can melt on the range cooktop. If these items melt they may damage the cooktop.

CAUTION

Do not straddle cookware over two burner areas unless the cookware is specifically designed for that purpose.

SETTING SURFACE CONTROLS

Setting surface controls

The ability to heat food quickly and in large volumes increases as the burner size increases. Your gas appliance may be equipped with many different sized surface burners.

It is important to select cookware that is suitable for the amount and type of food being prepared. Select a burner and flame size appropriate for the cookware size.

- The standard size burner or burners may be used for most surface cooking needs.
- Small burners are best used for low-flame heating of small amounts of food.
- Large burners are best for bringing large quantities of liquid to temperature or heating larger quantities of food.

Setting a surface burner:

1. Place cooking utensil on center of surface burner grate. Be sure the cooking utensil rests stable on the burner grate.
2. Push the burner's surface control knob in and turn counterclockwise out of the OFF position (Figure 7).
3. Release the surface control knob and rotate to the LITE position (🔥). Visually check that the burner has a steady gas flame.
4. Once the surface burner has a flame, push the surface control knob in and turn counterclockwise to the desired flame size setting. Adjust the flame as needed using the knob markings.

→ IMPORTANT

- NEVER place or straddle a cooking utensil over two different surface cooking areas at the same time unless the cookware is specifically designed for the purpose.
- DO NOT cook with a surface control knob left in the lite position (🔥). The electronic ignitor will continue to spark. Turn the control knob out of the lite position and adjust the flame size.
- Do not place aluminum foil, or ANY material that can melt on the range cooktop. If items melt, they may permanently damage the appearance of the cooktop.

⚠ CAUTION

Do not place flammable items such as plastic wrappings, spoon holders, or plastic salt and pepper shakers on the cooktop when it is in use. These items could melt or ignite. Potholders, towels, or wooden spoons could catch fire if placed too close to the surface burners.

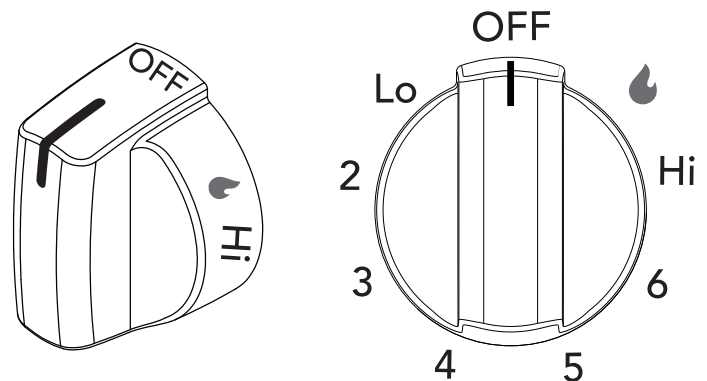

Figure 7: Surface control knob

⚡ NOTE

- When setting a surface control knob to the lite position, all of the electronic surface ignitors will spark at the same time. However, only the surface burner you are setting will ignite.
- In the event of an electrical power outage, the surface burners may be lit manually. To light a surface burner, hold a lit match to the burner head, then slowly turn the surface control knob to lite. Once the burner ignites, push in and turn knob out of lite then to the desired flame setting. Use caution when lighting surface burners manually.

SETTING SURFACE CONTROLS

Set proper burner flame size

The color of the flame is the key to proper burner adjustment. A good flame is clear, blue and hardly visible in a well-lighted room. Each cone of flame should be steady and sharp. Adjust or clean the burner if flame is yellow-orange.

For most cooking: start on the highest setting and then turn to a lower setting to complete the process. Use the recommendations below as a guide for determining proper flame size for various types of cooking (Figure 9).

For deep fat frying: use a thermometer and adjust the surface knob accordingly. If the fat is too cool, the food will absorb the fat and be greasy. If the fat is too hot, the food will brown so quickly that the center will be under-cooked. Do not attempt to deep fat fry too much food at once as the food will neither brown nor cook properly.

Flame size	Type of cooking
High flame	Start most foods; bring water to a boil; pan broiling
Medium flame	Maintain a slow boil; thicken sauces, gravies; steaming
Low flame	Keep foods cooking; poaching; stewing
These settings are based on medium-weight metal or aluminum pans with lids. Settings may vary when using other types of pans.	

Figure 9: Recommended flame settings for cooking

CAUTION

Never extend the flame beyond the outer edge of the cooking utensil. A higher flame wastes energy, and increases your risk of being burned by the flame (Figure 8).

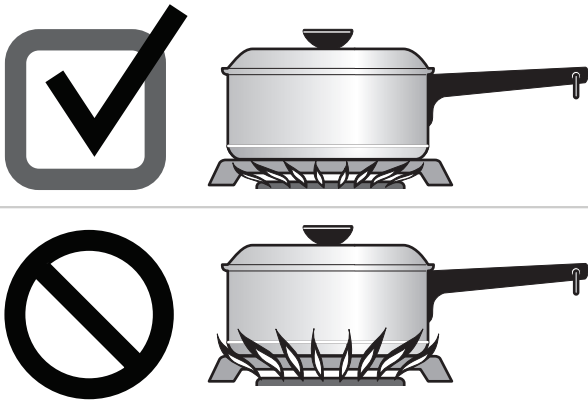

Figure 8: Flame settings

SETTING SURFACE CONTROLS

Cooking with a griddle (some models)

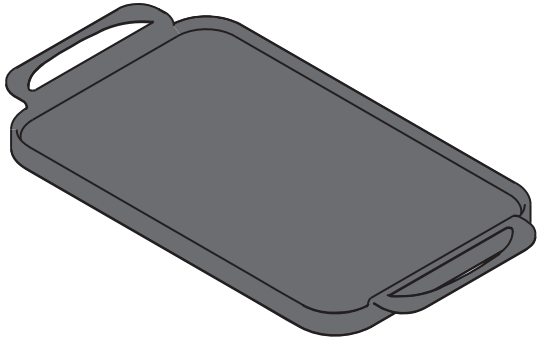

Figure 10: Griddle

The griddle is a versatile accessory that is perfect for cooking foods that require large flat surfaces such as pancakes, French toast, grilled sandwiches, bacon, and also for cooking different foods at the same time.

After use, let the griddle cool before washing. Hand wash with hot soapy water. Do not soak. Dry thoroughly. Do not put a griddle in a dishwasher.

If you would like to purchase a griddle, you can order one from Frigidaire.com.

Using the griddle:

Place the griddle securely on top of the burner grates. Preheat the griddle for 5 minutes on medium to medium low setting. Slow preheat ensures even heat distribution during the cooking process. **DO NOT** preheat the griddle on HI setting. Preheating on HI may warp the griddle and prevent even heat distribution.

Home Canning

Be sure to read and observe all the following points when home canning with your appliance. Check with the USDA (United States Department of Agriculture) Web site and be sure to read all the information they have available as well as follow their recommendations for home canning procedures.

- Use only a completely flat bottom canner with no ridges that radiate from the bottom center when home canning. Heat is spread more evenly when the bottom surface is flat. Use a straight-edge to check canner bottom.
- Make sure the diameter of the canner does not exceed 1 inch beyond the surface element markings or burner.
- It is recommended to use smaller diameter canners on electric coil and ceramic glass cooktops and to center canners on the burner grates.
- Start with hot tap water to bring water to boil more quickly.
- Use the highest heat setting when first bringing the water to a boil. Once boiling is achieved, reduce heat to lowest possible setting to maintain that boil.
- Use tested recipes and follow instructions carefully. Check with your local Cooperative Agricultural Extension Service or a manufacturer of glass jars for the latest canning information.
- It is best to can small amounts and light loads.
- Do not leave water bath or pressure canners on high heat for an extended amount of time.

BEFORE SETTING OVEN CONTROLS

Oven Vent Location

The oven is vented as shown below. When the oven is on, warm air is released through the vent. This venting is necessary for proper air circulation in the oven and good baking results. Do not block oven vent. Never close off the openings with aluminium foil or any other material. Steam or moisture may appear near the oven vent. This is normal.

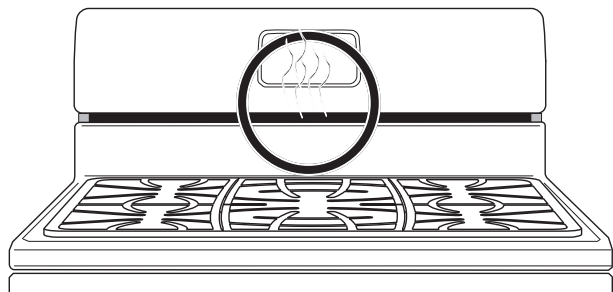

Figure 11: Oven vent

! WARNING

Protective Liners — **Do not** use aluminum foil or any other material or liners to line the oven bottom, walls, racks or any other part of the range. Doing so will alter the heat distribution, produce poor baking results, and possibly cause permanent damage to the oven interior. Improper installation of these liners may result in risk of electric shock or fire. During self clean, temperatures in the oven will be hot enough to melt foil.

! CAUTION

- Always use pot holders or oven mitts when using the oven. When cooking, the oven interior, oven exterior, oven racks, and cooktop will become very hot which can cause burns.
- Remove all oven racks before starting a self clean cycle. If oven racks are left inside the oven during a cleaning cycle, the slide ability of the oven racks may be damaged and all of the oven racks will lose their shiny finish.
- To prevent possible damage to the oven, do not attempt to close the oven door until all the oven racks are fully positioned back inside the oven cavity.

Types of oven racks

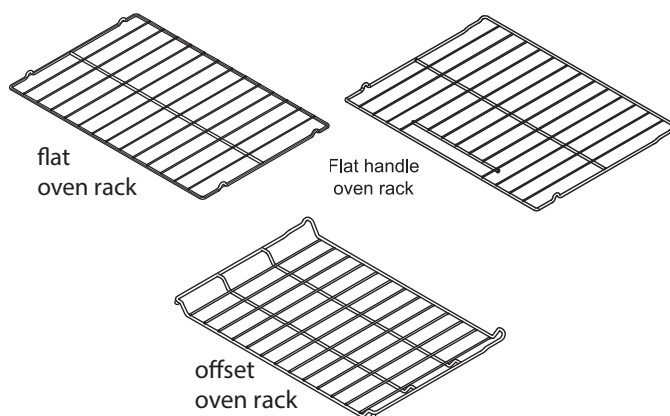

Figure 12: Oven rack types

- **Flat oven racks** may be used for most cooking needs and may be placed in most oven rack positions.
- The **offset oven rack** (some models) provides additional step down positions from the standard flat rack design. The offset design positions the base of the rack about $\frac{1}{2}$ of a rack position lower than the flat rack and may be used in most oven rack positions. To maximize oven cooking space, place the bottom oven rack in the lowest rack position for baking or roasting large cuts of meat.

Removing, replacing, and arranging flat or offset oven racks

Always arrange the oven racks when the oven is cool.

To remove - Pull the oven rack straight forward until it reaches the stop position. Lift up front of oven rack slightly and slide out.

To replace - Place the oven rack on the rack guides on both sides of oven walls. Tilt the front of oven rack upward slightly and slide the oven rack back into place. Be sure oven racks are level before using.

SETTING OVEN CONTROLS

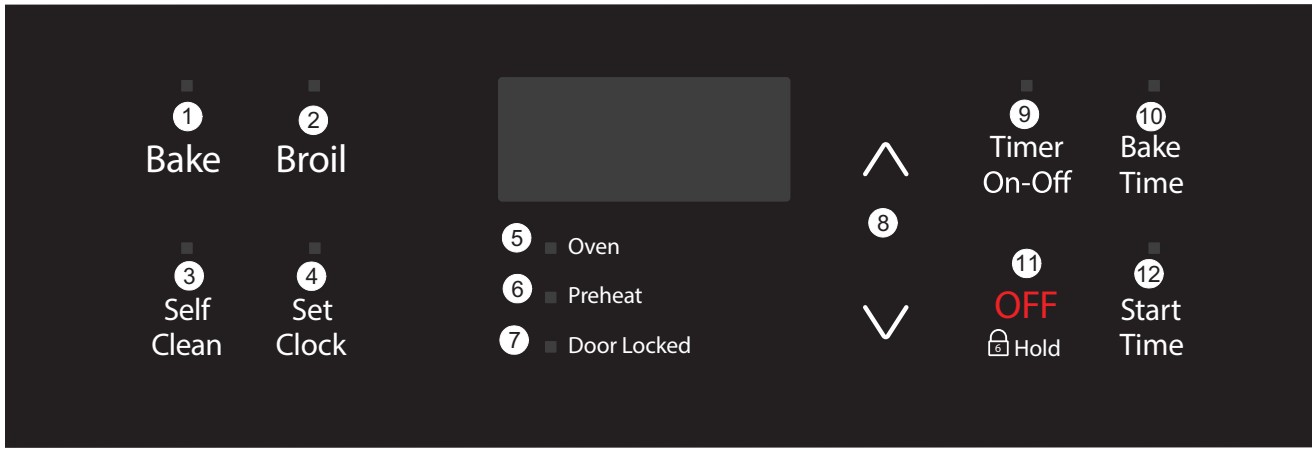

Figure 13: Model A

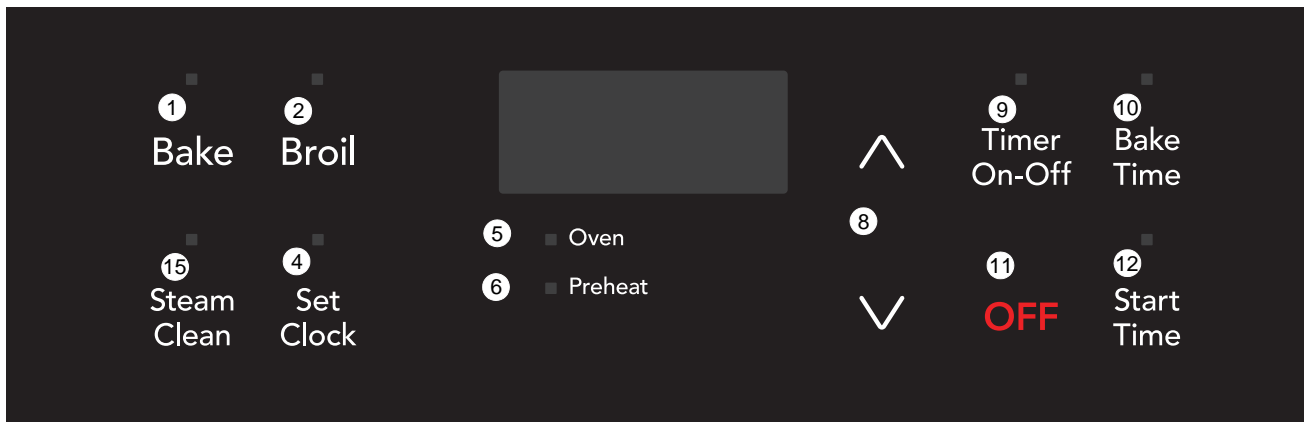

Figure 14: Model B

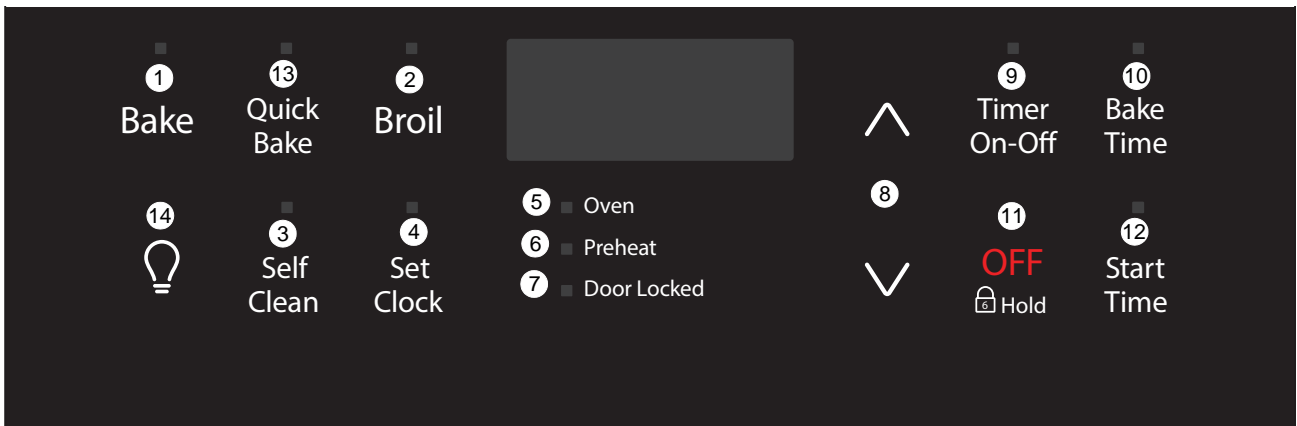

Figure 15: Model C

SETTING OVEN CONTROLS

Oven Control Features

1. **Bake** - Use to select Bake feature.
2. **Broil** - Use to set Broil feature.
3. **Self Clean** - (some models) Use to with arrow keys to set self clean cycle of 2 or 3 hours.
4. **Set Clock** - Use with arrow keys to set the time of day.
5. **Oven on indicator light** - The oven light will glow each time the oven turns on to maintain the set oven temperature.
6. **Preheat light** - The preheat light will glow when the oven is preheating or if the desired temperature is reset higher than the actual oven temperature.
7. **Door locked** - The door locked light will flash when the oven door locks and unlocks, when the oven door lockout is active, or when the self clean cycle feature is active.
8. **Up and Down arrows** - Use with the feature or function keys to set oven temperature, Bake Time, Start Time, clean time, and setting or adjusting the clock and minute timer.
9. **Timer on-off** - Use to set or cancel the minute timer. The minute timer does not start or stop any cooking function. Timer on-off is used to set the continuous bake function.
10. **Bake Time** - Enters the length of baking time desired.
11. **OFF** - Use to clear any feature previously entered except the time of day and minute timer. Also use OFF to activate oven lockout feature. (some models)
12. **Start Time** - Use to set the desired start time for baking and self clean. May be used with Bake Time to program a delayed timed bake.
13. **Quick Bake** - Quick Bake uses a fan to circulate the oven's heat uniformly and continuously around the oven. This improved heat distribution allows for fast, even cooking and browning results.
14. **Oven Light** - Use to turn on internal light when checking on food. Also will turn on when the oven door is open.
15. **Steam Clean** (some models) - The Steam Clean feature offers a chemical free and time saving method to assist in the routine cleaning of small and light soils.

Table 1: Minimum and maximum control settings^a

Feature	Mode	Minimum Temp. /Time	Maximum Temp. /Time
Bake		170°F (77°C)	550°F (288°C)
Quick Bake		300°F (77°C)	550°F (288°C)
Broil		LO - 400°F (205°C)	HI - 550°F (288°C)
Timer	12 Hr. Mode 24 Hr. Mode	0:01 Min. 0:01 Min	11:59 Hr./Min. 11:59 Hr./Min.
Clock Time	12 Hr. Mode 24 Hr. Mode	1:00 Hr./Min. 0:00 Min	12:59 Hr./Min. 23:59 Hr./Min.
Start Time (delays start of Bake or Quick Bake)	12 Hr. Mode 24 Hr. Mode	1:00 Hr./Min. 0:00 Min	12:59 Hr./Min. 23:59 Hr./Min
Bake Time	12 Hr. Mode 24 Hr. Mode	0:01 Min 0:01 Min	5:59 Hr./Min. 5:59 Hr./Min.
Self Clean Time		2 hours	3 hours



^a.

SETTING OVEN CONTROLS

Setting the Clock

When the appliance is first plugged in or when the power supply to the appliance has been interrupted, the display will flash **12:00**. It is recommended to always set the clock for the correct time of day before using the appliance.

To set the clock:

1. Press **clock** once (do not hold clock key down).
2. Within 5 seconds, press and hold  or  until the correct time of day appears in the display.



NOTE

The clock cannot be changed when the oven is set for cooking or self clean is active.

Temperature display (Fahrenheit/Celsius)

The electronic oven control is set to operate in Fahrenheit (°F) at the factory. The oven may be programmed for any temperature from 170°F to 550°F (77°C to 288°C).

To change the temperature to Celsius (°C) or from °C to °F:

1. Press **broil**. — — appears in the display.
2. Press and hold  until **HI** appears in the display.
3. Press and hold **broil** until °F or °C appears in the display.
4. Press  or  to change °F to °C or °C to °F. To accept the change, wait 6 seconds.

Continuous bake setting or 12-hour energy saving feature

The oven control has a built-in 12-hour energy saving feature that will shut off the oven if the oven is left on for more than 12 hours. The oven control can be programmed to override this feature for continuous baking.

To change the continuous bake setting:

1. Press and hold **timer on-off** for 6 seconds until a tone sounds. — — **hr** will appear in the display for continuous cooking. The current time of day will return to the display.
2. To cancel the continuous bake setting, press **timer on-off** and hold for 6 seconds until a tone sounds. **12 hr** will appear in display indicating that the control has returned to the 12-hour energy saving feature.

IMPORTANT

Changing to continuous bake or 12 hour mode does not change how the cooktop controls operate.

Setting a silent control panel

When selecting a function, an audible tone is heard each time a key is pressed. If desired, the control can be programmed for silent operation.

To set the controls for silent operation:

1. Press and hold **start time** for 6 seconds. The control will beep once and release the key.
2. The controls are now set for silent operation.

To return to non-silent operation:

1. Press and hold **start time** again for 6 seconds until the control beeps once and release the key.
2. The control is now set for audible operation.

SETTING OVEN CONTROLS

Setting oven lockout (models A and C)

The control can be programmed to lock the oven door and lockout the oven control keypad.

To set the oven lockout feature:

1. Press **OFF** and hold for 3 seconds. **Loc** will appear in display, the **door locked** indicator light will flash, and the motor driven door lock will begin to close. Allow about 15 seconds for the oven door to lock. Once the oven door is locked, the current time of day will appear in the display.
2. To cancel the Oven Lockout feature, press **OFF** and hold for 3 seconds. The control will unlock the oven door and resume normal operation.

NOTE

If any control key is pressed with the oven lockout feature active, **Loc** will appear in the display until the control key is released. But it does not disable the clock, kitchen timer, or the interior oven lights.

Operating oven light

(Models A and B)

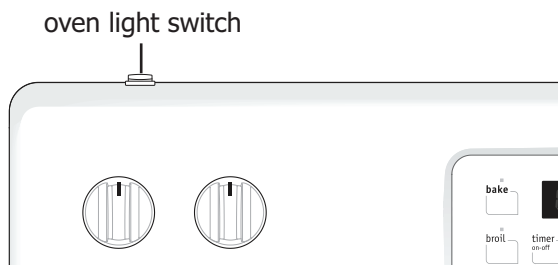

The interior oven light will automatically turn on when the oven door is opened. Press the oven light switch located on the upper left control panel to turn the interior oven light on and off whenever the oven door is closed.

The interior oven light is located at the upper left rear wall of the oven interior. To change the interior oven light, see "Changing the oven light" in the **Care & cleaning** section.



On **model C** the oven light switch is located on the left of the control. Press  to turn the interior oven lights on and off whenever the oven door is closed.



Setting the minute timer

1. Press **timer on-off**.
2. Press  to increase time in one-minute increments. Press and hold  to increase time in 10-minute increments. The timer can be set for any amount of time from 1 minute to 11 hours and 59 minutes.
3. When the set time ends, the timer will beep three times and will continue to beep three times every minute until **timer on-off** is pressed.

NOTE

The minute timer will not start or stop the cooking process. The minute timer can be used alone or while using any of the other oven features. If another feature is active when the minute timer is active, the minute timer will show in the display. To view information about other active features, press the key for that feature.

To change the timer while it is in use:

While the timer is active and shows in the display, press and hold  or  to increase or decrease the time remaining.

To cancel the minute timer before the set time has run out:

- Press **timer on-off** once.

SETTING OVEN CONTROLS

Setting Bake

The oven can be programmed to bake at any temperature from 170°F to 550°F (77°C to 288°C). The factory preset automatic bake temperature is 350°F (177°C).

Baking Tips

For best bake results:

- Fully preheat the oven before baking.
- When baking items like cookies, cakes, biscuits, and breads using a single rack place rack in position 4.
- When using any single rack for items like frozen pies, angel food cake, breads, and casseroles, use rack position 3.
- For best results when baking cakes using two oven racks, place racks in positions 3 and 5 (See [Figure 17](#)).
- When baking using two oven racks, position cookware as shown in [Figure 16](#).
- Allow at least 2 inches (5 cm) of space between cookware for proper air circulation.

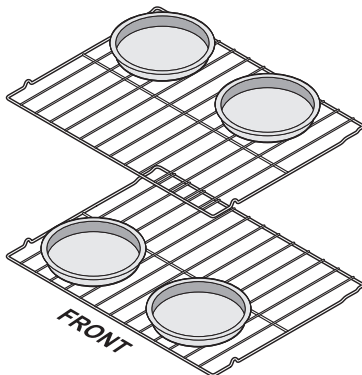





Figure 16: Pan positions two rack baking

To set Bake:

1. Press **Bake**. — — — appears in the display.
2. Within 5 seconds, press  or . The display will show **350°F** (177°C). The temperature can then be adjusted in 5°F (1°C) increments.
3. When a key is released, the oven will begin heating to the selected temperature. When the oven reaches the set temperature, the preheat indicator light will turn off and the control will beep three times.
4. To cancel the baking function, press **OFF**.

To change oven temperature after Bake has started:

1. Press **Bake**.
2. Press  or  to increase or decrease to a new temperature. The oven indicator light on the electronic display will turn on and off when using the bake feature and during preheat. This is normal and indicates that the oven is cycling to maintain the selected baking temperature. To cancel baking press **OFF**.

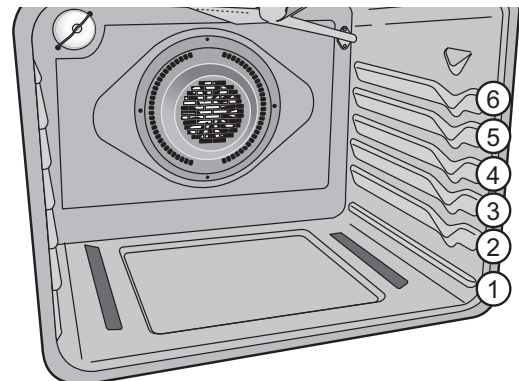

Figure 17: Rack positions for visible bake and hidden bake ovens

SETTING OVEN CONTROLS

Quick Bake (Model B)

Quick Bake uses a fan to circulate the oven's heat uniformly and continuously around the oven. The fan will turn on 6 minutes after the oven is set.

The oven may be programmed to Quick Bake at any temperature from 170°F to 550°F (77°C to 288°C). The factory preset Quick Bake temperature is 350°F (177°C).

Benefits of the Quick Bake feature:

- Most foods can be cooked faster and more evenly with Quick Bake.
- Multiple rack baking.

Baking Tips



- Fully preheat the oven when baking foods such as cookies, biscuits and breads.
- Reduce oven temperature 25°F from recipe's recommended oven temperature. Follow the remainder of the recipe's instructions using the minimum recommended cook time.
- When using 2 oven racks place racks in positions 3 and 5 for and position cookware as shown in [Figure 18](#).
- For single rack baking use rack position 4.

Roasting Tips



- Preheating is not necessary when roasting foods using Quick Bake. Do not cover foods when dry roasting.
- For Turkey, roasts and hams, use rack position 2.
- For small cuts of meat or poultry use rack positions 2 or 3.

Setting Quick Bake

To set Quick Bake:

1. Press **Quick Bake**. — — ° appears in the display.
2. Within 5 seconds, press  or . The display will show **350°F (177°C)**. The temperature can then be adjusted in 5°F (1°C) increments using the up or down arrow keys.
3. When a key is released, the oven will begin heating to the selected temperature.
4. When the oven reaches the set temperature, the preheat indicator light will turn off and the control will beep three times.
5. To cancel **Quick Bake**, press **OFF**.

To change oven temperature after Quick Bake has started:

1. Press **Quick Bake**.
2. Press  or  to increase or decrease to a new temperature. The oven indicator light on the electronic display will turn on and off when using the bake feature and during preheat. This is normal and indicates that the oven is cycling to maintain the selected baking temperature.
3. To cancel baking press **OFF**.

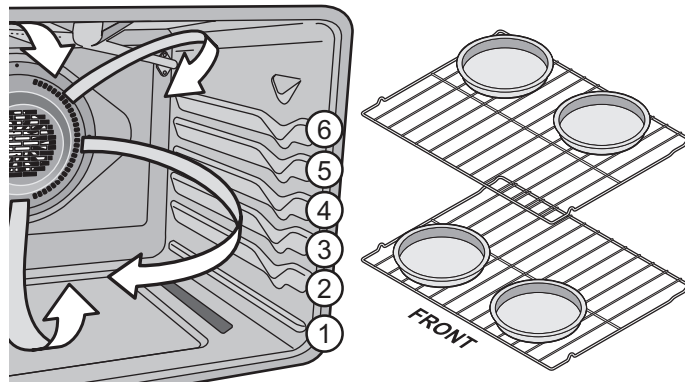





Figure 18: Pan spacing and oven rack positions

SETTING OVEN CONTROLS

Setting Bake Time

The **Bake Time** key sets the amount of time needed for baking. The oven will turn on immediately and stop automatically after the set bake time ends.

To program the oven to begin baking immediately and to shut off automatically (timed bake):

1. Be sure the clock is set to the correct time of day.
2. Place the food in the oven.
3. Press **Bake**. — — — ° appears in the display.
4. Within 5 seconds, press  or . The display will show **350°F (177°C)**. The temperature can then be adjusted in 5°F (1°C) increments,
5. Press **Bake Time.0:00** will appear in the display.
6. Press  or  until the desired baking time appears in the display.
7. The oven will turn on and begin heating.

When the set bake time runs out:

1. **End** will appear in the display, and the oven will shut off automatically.
2. The control will beep three times every 60 seconds as a reminder until **OFF** is pressed.

NOTE

Bake time will not operate when using the broil feature. Once the controls are set, the oven will come on and begin heating to the selected baking temperature. The oven temperature (or time of day) will show in the display.







Setting Start Time (delayed start)

Use the **start time** key to delay the starting time (delayed timed bake). The oven will turn on at a later time and stop automatically after the set bake time ends.

To program oven for a delayed start time and to shut-off automatically:

CAUTION

Food Poisoning Hazard. Do not let food sit for more than one hour before or after cooking. Doing so can result in food poisoning or sickness.

1. Be sure that the clock displays the correct time of day.
2. Place food in the oven.
3. Press **Bake**. — — — ° appears in the display. Within 5 seconds, press  or . The display will show **350°F (177°C)**. The temperature can then be adjusted in 5°F (1°C) increments.
4. Press **Bake Time. 0:00** will appear in the display.
5. Press  or  until desired baking time appears.
6. Press **start time**. The time of day will appear in the display.
7. Press  or  until the desired start time appears in the display.
8. Once the controls are set, the control calculates the time when baking will stop. The oven will turn on at the delayed start time and begin heating.

To change the oven temperature (or bake time) after baking has started:

1. Press the function you want to change.
2. Press  or  to adjust the setting.

NOTE

During a delayed timed bake, the preheat indicator light will not function until the set time to start cooking is reached.

SETTING OVEN CONTROLS

Setting Broil

Broiling is direct heat cooking and will produce some smoke. If smoke is excessive, place food further away from the element. Watch food to prevent burning.

When broiling, always remember to arrange the oven racks while oven is still cool. Position the rack as suggested in [Table 2](#).

WARNING

Should an oven fire occur, close the oven door and turn the oven off. If the fire continues, use a fire extinguisher. Do not put water or flour on the fire. Flour may be explosive.

CAUTION

Always use oven mitts. Oven racks will become very hot which can cause burns.

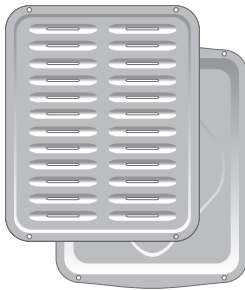



Figure 19: Broil pan and insert

NOTE

The broiler pan and the insert (some models) allow grease to drain and be kept away from the high heat of the broiler. Do not use the pan without the insert. Do not cover the insert with aluminum foil; the exposed grease could ignite. To purchase a broiling pan and insert, visit frigidaire.com

To set Broil

1. Arrange the oven rack while oven is still cool.
2. Press **Broil**. — — will appear in display.
3. Press  for **HI** broil or  for **LO** broil. Most foods may be broiled at the HI broil setting. Select the LO broil setting to avoid excess browning or drying of foods that should be cooked to the well-done stage.
4. For optimum results, preheat broil for 2 to 5 minutes before adding food.
5. If using a broil pan and insert, place insert on the broil pan. Place food on the insert
6. Place the broiler pan and insert on the oven rack.
7. Broil on one side until food is browned. Turn and broil food on other side.
8. When broiling is finished press **OFF**.

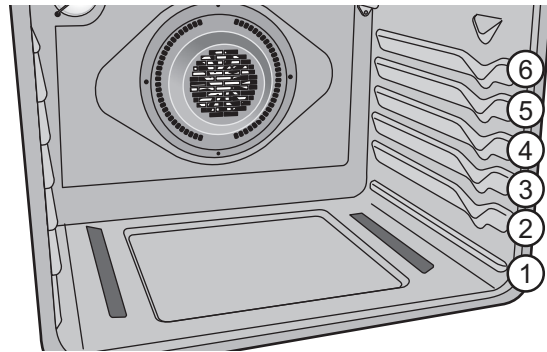

Figure 20: Rack positions

NOTE

Always pull the oven rack out to the stop position before turning or removing food.

SETTING OVEN CONTROLS

Table 2: Broil recommendations

Food item	Rack Position	Temp	Cook time in minutes		Internal Temperature	Doneness
			1st side	2nd side		
Steak 1" thick	5	HI(550°F)	6:00	5:00	135°F (57°C)	Rare**
Steak 1" thick	5 or 6	HI(550°F)	7:00	5:00	145°F (63°C)	Medium-well
Steak 1" thick	5 or 6	HI(550°F)	8:00	7:00	170°F (77°C)	Well
Pork Chops 3/4 "thick	5	HI(550°F)	8:00	6:00	170°F (77°C)	Well
Chicken - Bone In	4	LO(450°F)	20:00	10:00	170°F (77°C)	Well
Chicken Boneless	5	LO(450°F)	8:00	6:00	170°F (77°C)	Well
Fish	5	HI(550°F)	13:00	--	170°F (77°C)	Well
Shrimp	4	HI(550°F)	5:00	--	170°F (77°C)	Well
Hamburger 1" thick	5	HI(550°F)	6:00	5:00	135°F (57°C)	Rare**
Hamburger 1" thick	6	HI(550°F)	9:00	7:00	145°F (63°C)	Medium
Hamburger 1" thick	5	HI(550°F)	10:00	8:00	170°F (77°C)	Well

The U.S. Department of Agriculture states, "**Rare fresh beef is popular, but you should know that cooking it to only 140°F (60°C) means some food poisoning organisms may survive." (Source: Safe Food Book, Your Kitchen Guide, USDA Rev. June 1985.) The lowest temperature recommended by the USDA is 145°F (63°C) for medium rare fresh beef. For well done 170°F (77°C). All cook times shown are after 2 minutes of preheating.

SETTING OVEN CONTROLS

Self Clean (models A and C)

A self cleaning oven cleans itself with temperatures well above normal cooking temperatures which eliminate soils completely or reduces them to a fine powdered ash you can wipe away with a damp cloth.

While the oven is in operation, the oven heats to temperature much higher than those used in normal cooking. Sounds of metal expansion and contraction are normal. Odor is also normal because the food soil is being removed. Smoke may appear through the oven vent.

CAUTION

During the self cleaning cycle, the outside of the range can become very hot to the touch. Do not leave small children unattended near the appliance.

The health of some birds is extremely sensitive to the fumes given off during the self cleaning cycle of any range. Move birds to another well-ventilated room.

Do not force the oven door open. This can damage the automatic door locking system. Use caution when opening the door after the self cleaning cycle is complete. The oven may still be very hot.

Do not line the oven walls, racks, bottom, or any other part of the range with aluminum foil. Doing so will destroy heat distribution, produce poor baking results, and cause permanent damage to the oven interior (aluminum foil will melt to the interior surface of the oven).



Figure 21: Clean around the oven door gasket

IMPORTANT

Adhere to the following self clean precautions:

- Do not use oven cleaners or oven protective coatings in or around any part of the oven interior.
- Do not clean the oven door gasket (Figure 21). The woven material of the oven door gasket is essential for a good seal. Care should be taken not to rub, damage, or remove the gasket.
- Do not use any cleaning materials on the oven door gasket. Doing so could cause damage.
- Remove the broiler pan and insert, all utensils, and any aluminum foil. These items cannot withstand high cleaning temperatures and will melt.
- Completely remove all oven racks and any accessories. If the oven racks are not removed, they will lose their special coating properties and no longer slide in and out of the oven cavity easily.
- Remove any excessive spills. Any spills on the oven bottom should be wiped-up and removed before starting the self cleaning cycle. To clean, use hot, soapy water and a cloth. Large spills can cause heavy smoke or fire when subjected to high temperatures.
- Do not allow food spills with a high sugar or acid content (such as milk, tomatoes, sauerkraut, fruit juices, or pie filling) to remain on the surface as they may leave a dull spot even after cleaning.
- Clean any soil from the oven frame, the door liner outside the oven door gasket, and the small area at the front center of the oven bottom. These areas heat sufficiently to burn soil on. Clean with soap and water. These areas are shown in white (Figure 21).



SETTING OVEN CONTROLS

To set a self clean cycle or a delayed start self clean cycle:

1. Be sure the clock displays the correct time of day.

IMPORTANT

To start a self clean cycle immediately without a delay, skip Step 2 and Step 3 in the instructions provided below.

2. Press **Start Time**. The: in the time of day will flash.
3. Press and hold  to scroll to the time to start the delayed self clean cycle. Release the key when the desired time is displayed.
4. Press **clean**. --- appears in the display.
5. Press  until **3:00** appears in the display for a 3 hour self clean process, or push  until **2:00** appears in the display for a 2 hour self clean process.
6. As soon as the controls are set, the motor driven lock will begin to close automatically and the **door locked** indicator light will flash. Do not open the oven door while the light is flashing (allow about 15 seconds for the oven door to lock).
7. **CLn** will appear in the display during the self clean cycle, and the **door locked** light will glow until the self cleaning cycle is complete or cancelled and the oven temperature has cooled.

When the self clean cycle has completed:

1. The time of day will appear in the display window, and the Self **Clean** indicator light and **Door Locked** light will continue to glow.
2. Once the oven has cooled down for about 1 hour and the **Door Locked** light has gone out, the oven door may be opened.
3. To avoid possible burns, use care when opening the oven door after the self cleaning cycle. Stand to the side of the oven when opening the door to allow hot air or steam to escape.

To stop or interrupt a self clean cycle (once it has been activated):

1. Press **OFF**.
2. Once the oven has cooled down for about 1 hour and the **door locked** light has turned off, the oven door can be opened.
3. Restart the self clean cycle once all conditions have been corrected.

NOTE

Whenever the self clean feature is active, you may check the amount of time remaining in the self clean cycle by pressing the **clean** key. Remember the range door cannot be opened until the range has cooled sufficiently. You will need to add about 1 hour to the time displayed before you can use the range for cooking.

When the oven is cool, wipe away any residue or powdered ash with a damp cloth or paper towel.

SETTING OVEN CONTROLS

Steam Clean (Model B)

The Steam Clean feature offers a chemical free and time saving method to assist in the routine cleaning of small and light soils.

CAUTION

- Do not add bleach, ammonia, oven cleaner, or any other abrasive household cleaners to the water used for Steam Clean.
- Before cleaning any part of the oven, be sure all controls are turned off and the oven is cool. The oven may be hot and can cause burns.

Be sure the oven is level and cool before starting Steam Clean. If the oven temperature is above room temperature a triple beep will be heard and the function will not start. Steam Clean produces best results when started with a cool oven.

To set a Steam Clean cycle:

1. Remove all racks and oven accessories.
2. Scrape or wipe loose debris and grease from the oven bottom.
3. Pour 1 cup of tap water onto the oven bottom. (Figure 22) Close oven door.

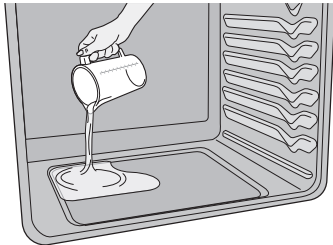

Figure 22: Add 1 cup of tap water

4. Press **Steam Clean**.
5. Press either the **up arrow** or **down arrow** to activate. **St Cn** will appear in the display.
6. The time remaining in the Steam Clean cycle is shown in the display. Do not open the door during this time. If door is open while in steam clean (d-O) will appear in the display.
7. When the steam clean cycle is complete an alert will sound and the **END** message will show in the display. Press **OFF** to return to the clock. Press **OFF** at any time to cancel Steam Clean.

8. Take care opening the door when the steam clean is finished. Stand to the side of the oven out of the way of escaping vapor.
9. Wipe oven cavity and bottom. Do not clean oven door gasket (Figure 23). Avoid leaning or resting on the oven door glass while cleaning cavity.

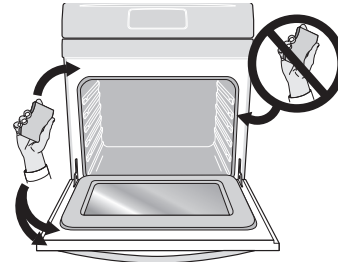

Figure 23: Clean around the oven door gasket

Notes:

- Opening the oven door during the steam clean cycle prevents the water from reaching the temperature needed to clean.
- For best results, clean oven immediately after the cycle is complete. Steam clean works best for soils on the oven bottom.
- A non-abrasive scouring pad, stainless steel sponge, plastic scraper, or eraser style cleaning pad (without cleaner) can be used for difficult soils. Moisten pads with water before use.
- Place a paper towel or cloth in front of the oven to capture any water that may spill out while wiping out.
- Do not leave the residual water in the oven for any length of time.
- Some condensation or water vapor may appear close to the oven vent and the oven door glass. This is normal. The oven gasket may become damp; do not wipe dry.
- Local water sources often contain minerals (hard water). If hard water deposits occur, wipe cavity with a 50/50 solution of water and vinegar or 50/50 solution of lemon juice and water.
- Steam clean cannot be programmed with a delayed start time.

SETTING OVEN CONTROLS

Adjusting the oven temperature

Your appliance has been factory calibrated and tested to ensure an accurate baking temperature. For the first few uses, follow your recipe times and temperature recommendations carefully.



If you think the oven is cooking too hot or too cool for your recipe times, you can adjust the control so the oven cooks hotter or cooler than the temperature displayed.

NOTE

Do not use oven thermometers such as those found in grocery stores to check the temperature settings inside your oven. These oven thermometers may vary as much as 20 to 40 degrees from actual temperatures.

- Oven temperature adjustments made will not affect the broil or self cleaning feature temperatures.
- If the display is set for Celsius, adjustments made will be in 1°C increments with each press of arrow keys.

To adjust oven temperature:

1. Press **Bake**.
2. Set the temperature to 550°F (288°C) by pressing and holding .
3. Within 3 seconds, press and hold **Bake** until numeric digit(s) appear. Release **Bake** key. The display now indicates the amount of degrees offset between the original factory temperature setting and the current temperature setting. If the oven control has the original factory calibration, the display will read **00**.
4. The temperature can now be adjusted up or down 35°F (19°C), in 5°F (or 1°C) increments.
5. Press and hold  to adjust the temperature higher until the desired amount of offset appears in the display. When lowering the oven temperature using , a minus sign (-) will appear before the number to indicate that the oven will be cooler by the displayed amount of degrees.
6. When you have made the desired adjustment, press **OFF** to go back to the time of day display.

CARE AND CLEANING

Remove spills and any heavy soiling as soon as possible. Regular cleaning will reduce the difficulty of major cleaning later.

CAUTION

- Before cleaning any part of the appliance, be sure all controls are turned off and the appliance is cool.
- If ammonia or appliance cleaners are used, they must be removed and the appliance must be thoroughly rinsed before operating. Follow manufacturer's instructions and provide adequate ventilation.

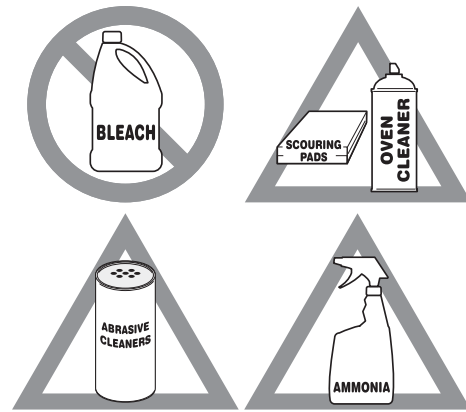

Figure 24: Use cleaners with caution

Surface or Area	Cleaning Recommendation
Aluminum and vinyl	Using a soft cloth, clean with mild dish detergent and water. Rinse with clean water, dry and polish with a soft, clean cloth.
Painted and plastic control knobs Painted body parts Painted decorative trims	Using a soft cloth, clean with mild dish detergent and water or a 50/50 solution of vinegar and water. Rinse with clean water, dry and polish with a soft, clean cloth. Glass cleaners may be used, but do not apply directly to surface; spray onto cloth and wipe.
Control panel	Using a soft cloth, clean with mild dish detergent and water or a 50/50 solution of vinegar and water. Do not spray liquids directly on the oven control and display area. Do not use large amounts of water on the control panel - excess water on the control area may cause damage to the appliance. Do not use other liquid cleaners, abrasive cleaners, scouring pads, or paper towels - they will damage the finish.
Control knobs	Using a soft cloth, clean with mild dish detergent and water or a 50/50 solution of vinegar and water. To remove control knobs: turn to the OFF position, grasp firmly, and pull off the shaft. To replace knobs after cleaning, line up the OFF markings and push the knobs into place.
Stainless Steel	Using a soft cloth, clean with mild dish detergent and water or a 50/50 solution of vinegar and water. Rinse with clean water, dry with a soft clean cloth. Do not use cleaners containing abrasives, chlorides, chlorine, or ammonia.
Smudge Proof™ Stainless Steel Black Stainless Steel	Using a soft cloth, clean with mild dish detergent and water or a 50/50 solution of vinegar and water. Rinse with clean water, dry with a soft clean cloth. Do not use appliance cleaner, stainless steel cleaner, or cleaner containing abrasives, chlorides, chlorine, or ammonia. These cleaners may damage the finish.

CARE AND CLEANING

Porcelain-enameled broiler pan and insert	Rinse with clean water and a damp cloth. Scrub gently with a soapy, non-abrasive scouring pad to remove most spots. Rinse with a 50/50 solution of clean water and ammonia. If necessary, cover difficult spots with an ammonia-soaked paper towel for 30 to 40 minutes. Rinse and wipe dry with a clean cloth. Remove all cleaners or future heating could damage the porcelain. Do not allow food spills with a high sugar or acid content (milk, tomatoes, sauerkraut, fruit juices or pie filling) to remain on porcelain surfaces. These spills may cause a dull spot even after cleaning.
Porcelain door liner	
Porcelain body parts	
Self-cleaning oven interior	Before setting a self-clean cycle, clean soils from the oven frame, areas outside the oven door gasket, and the small area at the front center of the oven bottom. See “Self Clean (models A and C)” on page 29 .
Oven door	Use mild dish detergent and water or a 50/50 solution of vinegar and water to clean the top, sides, and front of the oven door. Rinse well. Glass cleaner may be used on the outside glass of the door. Ceramic smoothtop cleaner or polish may be used on the interior door glass. Do not immerse the door in water. Do not spray or allow water or cleaners to enter the door vents. Do not use oven cleaners, cleaning powders, or any harsh abrasive cleaning materials on the outside of the oven door. Do not clean the oven door gasket. The oven door gasket is made of a woven material which is essential for a good seal. Do not rub, damage, or remove this gasket.
Gas cooktop surface burners	See “Cleaning the sealed burners” on page 35 .
Gas cooktop surface grates	Use a non-abrasive plastic scrubbing pad and mild abrasive cleanser. Do not allow food spills with a high sugar or acid content (milk, tomatoes, sauerkraut, fruit juices or pie filling) to remain on the burner grates or burner caps. These spills may cause a dull spot even after cleaning. Clean these spills as soon as surfaces are cool. Thoroughly dry immediately following cleaning.
Gas cooktop burner caps	

CARE AND CLEANING

Aluminum Foil and Utensils

! WARNING

- Never cover any slots, holes, or passages in the oven bottom or cover an entire oven rack with materials such as aluminum foil. Aluminum foil linings may trap heat, causing a fire hazard.
- Protective Liners — Do not use aluminum foil to line the oven bottom. Improper installation of these liners may result in risk of electric shock or fire.

Cleaning the sealed burners

➔ IMPORTANT

- Aluminum foil - Use of aluminum foil on a hot cooktop can damage the cooktop. Do not use thin aluminum cooking utensils or allow aluminum foil to touch the surface elements under any circumstances.
- Aluminum utensils - The melting point of aluminum is much lower than that of other metals. Care must be taken when aluminum pots or pans are used on the cooktop. If aluminum pans are allowed to boil dry when using the cooktop, not only will the utensil be damaged or destroyed, but it may fuse to, break, or mark the ceramic glass surface, permanently damaging the cooktop surface.

To avoid possible burns, do not attempt cleaning before turning off all surface burners and allowing them to cool.

Any additions, changes, or conversions required in order for this appliance to satisfactorily meet the application needs must be made by an authorized qualified Agency. Routinely clean the cooktop. Wipe with a clean, damp cloth and wipe dry to avoid scratches. Keeping the surface burner head ports and slots clean will prevent improper ignition and an uneven flame.

To clean recessed and contoured areas of cooktop:

- If a spill occurs on or in the recessed or contoured areas, blot up spill with an absorbent cloth.
- Rinse with a clean, damp cloth and wipe dry.

! CAUTION

- To avoid possible burns do not attempt to operate the surface burners without the burner caps.
- Do not use spray oven cleaner on the cooktop.

To clean burner heads:

1. Remove the burner cap from the burner head (see [Figure 25](#)). Clean the cap with hot soapy water and dry thoroughly.

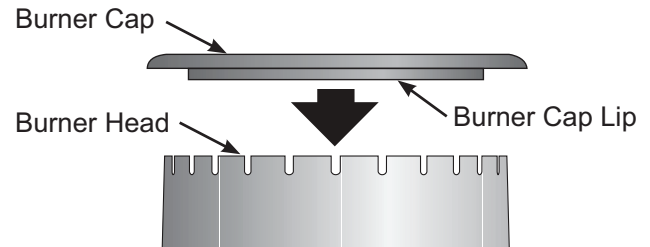

Figure 25: Burner Cap

2. For burned-on and dried spills, apply hot soapy water to the burner head. Allow time for the soils to soften.

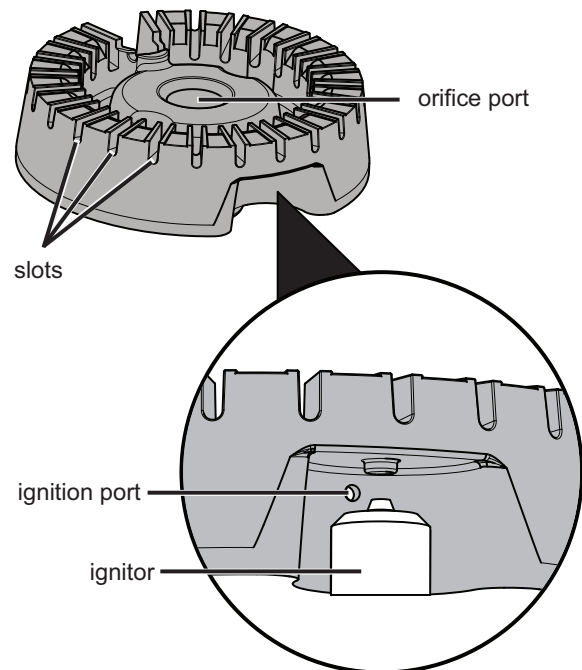

Figure 26: Sealed burner components

3. Use a toothbrush to clean all over the burner head (see [Figure 26](#)).
4. Use the toothbrush to clean the slots and holes in the burner (see [Figure 26](#)).
5. Use a needle or fine wire to clean out the ignition port (see [Figure 26](#)).

CARE AND CLEANING

- Wipe the burner head clean with a soft, clean cloth, sponge, or scratch-free cleaning pad.
- Before using the cooktop again, make sure the burner caps are properly placed and seated on the burner heads. When placed correctly, the burner cap is centered on the burner head and will click into place on the burner head. You can wiggle the cap to test placement, it should not move off the burner head (see “Assembly of the burner caps” on page 13).

Important notes:

- The surface burner heads are secured to the cooktop and must be cleaned in place on the cooktop.
- Always keep the surface burner caps in place whenever a surface burner is in use.
- When replacing the burner caps, be sure the burner caps are seated firmly on top of the burner heads.
- For proper flow of gas and ignition of burners do not allow spills, food, cleaning agents, or any other material to enter the gas orifice port opening.

Replacing the Oven Light

CAUTION

Be sure the oven is unplugged and all parts are cool before replacing the oven light.

Replacing the oven interior light bulb:

The interior oven light is located at the rear of the oven cavity and covered with a glass shield. The glass shield must be in place whenever the oven is in use (Figure 27).

- Turn electrical power off at the main source or unplug the appliance.
- Remove the interior oven light shield after removing the wire holder by carefully moving the wire to the side of the glass shield. The tension from the wire holds the glass shield in place.
- Pull the shield straight out. Do not twist or turn.
- Replace the bulb with a new appliance bulb.
- Replace the glass oven light shield. Replace wire holder.
- Turn the power back on again at the main source (or plug the appliance back in).

- Be sure to reset the time of day on the clock.

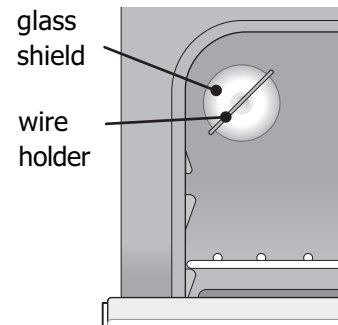

Figure 27: Oven light protected by glass shield

To remove and replace storage drawer (some models)

Use the storage drawer for storing cooking utensils. The drawer can be removed to facilitate cleaning under the range. Use care when handling the drawer.

To remove the drawer:

- Pull empty drawer out until it stops.
- Tilt up the front of the drawer up and pull it out over the glide stop.

To replace the drawer:

- Insert the back of the drawer into the opening.
- Lift up the drawer and line up the drawer supports with the rails. Make sure to clear the glide stop.
- Push in the drawer until it stops.

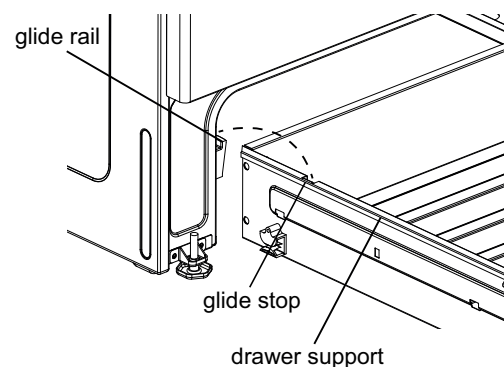

Figure 28: Parts of storage drawer

Removing and Replacing the Oven Door

To remove oven door:

CAUTION

The door is heavy. For safe, temporary storage, lay the door flat with the inside of the door facing down.

1. Open oven door completely, horizontal with floor (See [Figure 29](#)).
2. Pull the door hinge locks on both left and right door hinges down from the oven frame completely towards the oven door (See [Figure 30](#)). A tool such as a small flat-blade screwdriver may be required.
3. Firmly grasp both sides of oven door along the door sides. Do not use the oven door handle (See [Figure 31](#)).
4. Close the door to approximately 10 degrees from the door frame (See [Figure 31](#)).
5. Lift the oven door hinge arms over the roller pins located on each side of the oven frame (See [Figure 32](#)).

To replace oven door:

1. Firmly grasp both sides of oven door along the door sides. Do not use the oven door handle (See [Figure 31](#)).
2. Holding the oven door at the same angle as the removal position, seat the hook of the hinge arm over the roller pins located on each side of the oven door frame (See [Figure 31](#) and [Figure 32](#)). The hook of the hinge arms must be fully seated onto the roller pins.
3. Fully open the oven door, horizontal with floor (See [Figure 29](#)).
4. Push the door hinge locks up towards and into the oven frame on both left and right oven door hinges to the locked position (See [Figure 30](#)).
5. Close the oven door.

IMPORTANT

Special door care instructions - Most oven doors contain glass that can break. Do not hit the glass with pots, pans, or any other object. Scratching, hitting, jarring, or stressing the glass may weaken its structure, causing an increased risk of breakage at a later time. Do not close the oven door until all of the oven racks are fully in place.

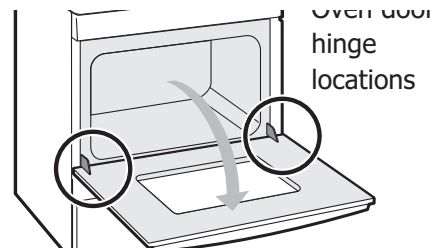

Figure 29: Door hinge location

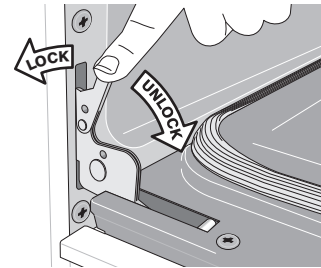

Figure 30: Door hinge locks

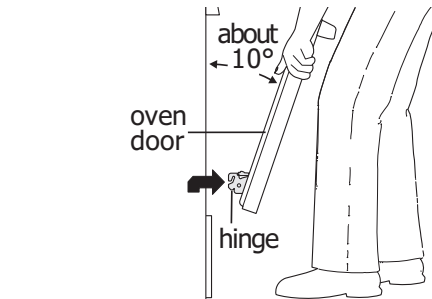

Figure 31: Holding door for removal

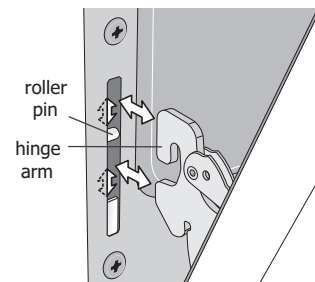







Figure 32: Replacement and location of hinge arm and roller pin

BEFORE YOU CALL

Oven Baking

For best cooking results, preheat the oven before baking cookies, breads, cakes, pies, pastries, etc. There is no need to preheat the oven for roasting meat or baking casseroles. The cooking times and temperatures needed to bake a product may vary slightly from your previously owned appliance.

Baking Problems and Solutions

Baking Problems	Causes	Corrections
Cookies and biscuits burn on the bottom. 	<ul style="list-style-type: none"> • Cookies and biscuits put into oven before oven is preheated. • Oven rack is overcrowded. • Dark pan absorbs heat too fast. 	<ul style="list-style-type: none"> • Allow oven to preheat to desired temperature before placing food in oven. • Choose pan sizes that will permit at least 2" of air space (5.1 cm) on all sides when placed in the oven. • Use a medium weight shiny baking sheet.
Cakes too dark on top or bottom 	<ul style="list-style-type: none"> • Cakes put in oven before oven is preheated. • Rack position too high or too low. • Oven too hot. 	<ul style="list-style-type: none"> • Allow oven to preheat to the selected temperature before placing food in the oven. • Use proper rack position for baking needs. • Set oven temperature 25°F (13°C) lower than recommended.
Cakes not done in center 	<ul style="list-style-type: none"> • Oven too hot. • Incorrect pan size. • Pan not centered in oven. • Glass cookware slow heat conductor. 	<ul style="list-style-type: none"> • Set oven temperature 25°F (13°C) lower than recommended. • Use pan size suggested in recipe. • Use proper rack position and place pan so there are at least 2" (5.1 cm) of space on all sides of pan. • Reduce temperature and increase cook time or use shiny bakeware.
Cakes not level. 	<ul style="list-style-type: none"> • Oven not level. • Pan too close to oven wall or rack overcrowded. • Pan warped. • Oven light left on while baking. 	<ul style="list-style-type: none"> • Place a marked glass measuring cup filled with water on the center of the oven rack. If the water level is uneven, refer to the installation instructions for leveling the oven. • Use proper rack position and place pan so there are at least 2" (5.1 cm) of space on all sides of pan. • Do not use pans that are dented or warped. • Do not leave the oven light on while baking.
Foods not done when cooking time is over. 	<ul style="list-style-type: none"> • Oven too cool. • Oven overcrowded. • Oven door opened too frequently. 	<ul style="list-style-type: none"> • Set oven temperature 25°F (13°C) higher than suggested and bake for the recommended time. • Be sure to remove all pans from the oven except the ones to be used for baking. • Open oven door only after the shortest recommended baking time.

Solutions to Common Problems:

Before you call for service, review the following list. It may save you time and expense. Possible solutions are provided with the problem listed.

Problem	Cause / Solution
Entire appliance does not operate.	<p>Appliance not connected. Make sure power cord is plugged properly into outlet. Check your fuse box or breaker box to make sure the circuit is active.</p> <p>Electrical power outage. Check house lights to be sure. Call your local electric company for service outage information.</p>
Oven Problems	
Poor baking results.	<p>Many factors affect baking results. Use proper oven rack position. Center food in the oven and space pans to allow air to circulate. Preheat the oven to the set temperature before placing food in the oven. Try adjusting the recipe's recommended temperature or baking time. See "Adjusting the oven temperature" on page 32 if you feel the oven is too hot or too cool.</p>
Flames inside oven or smoking from oven vent.	<p>Excessive spills in oven. Grease or food spilled onto the oven bottom or oven cavity. Wipe up excessive spills before starting the oven. If flames or excessive smoke are present when using broil, see "Setting Broil" on page 27.</p>
Oven smokes excessively when broiling.	<p>Incorrect setting. Follow the "Setting Broil" instructions on page 27.</p> <p>Meat too close to the broil element or burner. Reposition the broil pan to provide proper clearance between the meat and broil element or burner. Remove excess fat from meat. Cut remaining fatty edges to prevent curling, but do not cut into lean.</p> <p>Grease build up on oven surfaces. Regular cleaning is necessary when broiling frequently. Grease or food splatters will cause excessive smoking.</p>
Oven control panel beeps and displays any F or E code error.	<p>Oven control has detected a fault or error condition. To clear the error, press the OFF key on the control panel. Once the error code is cleared, try the bake or broil function. If the F or E code error repeats, turn off the power to appliance, wait 5 minutes, and then repower the appliance. Set the clock with correct time of day. Try the bake or broil function again. If the fault recurs, press the OFF key to clear.</p>
Oven portion of appliance does not operate.	<p>Be sure the regulator gas valve is turned to ON. See installation instructions.</p> <p>The time of day is not set. The clock must be set in order to operate the oven. See "Setting the Clock" on page 22.</p> <p>Be sure the oven controls are set properly for the desired function. See "Setting Oven Controls" starting on page 20 and review instructions for the desired cooking function in this manual or see "Entire appliance does not operate." in this checklist.</p>

BEFORE YOU CALL

Problem	Cause / Solution
Cooktop Problems	
Surface burners do not ignite.	<p>Surface control knob was not completely turned to LITE (☛). Push in and turn the surface control knob to LITE until the burner ignites and then turn the control knob to the desired flame size.</p> <p>Burner ports are clogged. With the burner OFF and cool, use a small-gauge wire or needle to clean the burner head slots and ignition ports. See “Cleaning the sealed burners” in the Care & Cleaning section on page 35 for additional cleaning instructions.</p> <p>Range power cord is disconnected from outlet (electric ignition models only). Be sure the power cord is securely plugged into the power outlet.</p> <p>Circuit is broken. Check breaker box or fuse box.</p> <p>Electrical power outage. Burners may be lit manually. See “Setting surface controls” on page 16.</p>
Surface burner flame uneven or only part way around burner cap.	<p>Burner slots or ports are clogged. With the surface burner OFF and cool, clean ports with a small-gauge wire or needle. If moisture is present after cleaning, lightly fan the flame and allow the burner to operate until flame is full.</p> <p>Burner caps are not seated properly. Check that all burner caps are level and seated correctly on the burner heads. See “Cleaning the sealed burners” in the Care & Cleaning section on page 35 for additional cleaning instructions.</p>
Surface burner flame is too high.	<p>Surface control knob is set too high. Adjust to a lower flame setting.</p> <p>Burner caps are not seated properly. Check that all surface burner caps are level and seated correctly on the surface burner heads. See “Cleaning the sealed burners” in the Care & Cleaning section on page 35 for additional cleaning instructions.</p> <p>Incorrect L.P. conversion. Refer to L.P. conversion kit instructions to correct.</p>
Surface burner flame is orange.	<p>Dust particles in main gas line. Allow the burner to operate a few minutes until flame turns blue. In coastal areas, a slightly orange flame is unavoidable due to salt content in the air.</p> <p>Incorrect L.P. conversion. Refer to L.P. conversion kit instructions to correct.</p>
Self Clean Problems	
Self clean does not work.	<p>Oven control not set properly. See “Self Clean (models A and C)” on page 29.</p>
Oven racks discolored or do not slide easily.	<p>Oven racks left in oven cavity during self clean. Remove oven racks from oven cavity before starting a self-clean cycle. Clean by using a mild abrasive cleaner following manufacturer's instructions. Rinse with clean water, dry, and replace in oven.</p>
Soil not completely removed after self clean.	<p>Self clean was interrupted. Review instructions on “Self Clean (models A and C)” on page 29.</p> <p>Excessive spills on oven bottom. Remove excessive spills before starting self clean.</p> <p>Failure to clean soil from the oven frame, the door liner outside the oven door gasket, and the small area at the front center of the oven bottom. These areas are not in the self-cleaning area, but get hot enough to burn on residue. Clean these areas before starting the self-cleaning cycle. Burned-on residue can be cleaned with a stiff nylon brush and water or a nylon scrubber. Be careful not to damage the oven gasket.</p>

BEFORE YOU CALL

Problem	Cause / Solution
The oven control display shows "SPr" and self-clean is not working.	The cooktop should not be used during a self-clean cycle. On some models, turning on any cooktop surface burner will cause the clean cycle to cancel. If the clean cycle is canceled, the oven control display will show "SPr" for 5 seconds. The oven door will remain locked until the oven has cooled down below cleaning temperature. If the oven is below cleaning temperature, the user can start another clean cycle immediately. If the oven is in cleaning temperature range, another self-clean cycle can be set once the door unlocks (up to 4 hours).
Other Problems	
Appliance is not level.	Be sure the floor is level, strong, and stable enough to adequately support the range. If the floor is sagging or sloping, contact a carpenter to correct the situation. Poor installation. Place the oven rack in the center of the oven. Place a level on the oven rack. Adjust the leveling legs at the base of the appliance until the rack is level. Kitchen cabinet alignment may make range appear not level. Be sure cabinets are square and have sufficient room for appliance clearance.
Cannot move appliance easily. Appliance must be accessible for service.	Cabinets not square or are built in too tightly. Contact the builder or installer to make the appliance accessible. Carpet interferes with appliance. Provide sufficient space so the appliance can be lifted over carpet. Installation over carpet is not advised. See the installation instructions for guidelines specific to your appliance.
Oven light does not work.	Be sure the oven light is secure in the socket. See "Replacing the Oven Light" on page 36 .

BEFORE YOU CALL

WARRANTY

Your appliance is covered by a one year limited warranty. For one year from your original date of purchase, Electrolux will pay all costs for repairing or replacing any parts of this appliance that prove to be defective in materials or workmanship when such appliance is installed, used and maintained in accordance with the provided instructions.

Exclusions

This warranty does not cover the following:

1. Products with original serial numbers that have been removed, altered or cannot be readily determined.
2. Product that has been transferred from its original owner to another party or removed outside the USA or Canada.
3. Rust on the interior or exterior of the unit.
4. Products purchased "as-is" are not covered by this warranty.
5. Food loss due to any refrigerator or freezer failures.
6. Products used in a commercial setting.
7. Service calls which do not involve malfunction or defects in materials or workmanship, or for appliances not in ordinary household use or used other than in accordance with the provided instructions.
8. Service calls to correct the installation of your appliance or to instruct you how to use your appliance.
9. Expenses for making the appliance accessible for servicing, such as removal of trim, cupboards, shelves, etc., which are not a part of the appliance when it is shipped from the factory.
10. Service calls to repair or replace appliance light bulbs, air filters, water filters, other consumables, or knobs, handles, or other cosmetic parts.
11. Surcharges including, but not limited to, any after hour, weekend, or holiday service calls, tolls, ferry trip charges, or mileage expense for service calls to remote areas, including the state of Alaska.
12. Damages to the finish of appliance or home incurred during installation, including but not limited to floors, cabinets, walls, etc.
13. Damages caused by: services performed by unauthorized service companies; use of parts other than genuine Electrolux parts or parts obtained from persons other than authorized service companies; or external causes such as abuse, misuse, inadequate power supply, accidents, fires, or acts of God.

DISCLAIMER OF IMPLIED WARRANTIES; LIMITATION OF REMEDIES

CUSTOMER'S SOLE AND EXCLUSIVE REMEDY UNDER THIS LIMITED WARRANTY SHALL BE PRODUCT REPAIR OR REPLACEMENT AS PROVIDED HEREIN. CLAIMS BASED ON IMPLIED WARRANTIES, INCLUDING WARRANTIES OF MERCHANTABILITY OR FITNESS FOR A PARTICULAR PURPOSE, ARE LIMITED TO ONE YEAR OR THE SHORTEST PERIOD ALLOWED BY LAW, BUT NOT LESS THAN ONE YEAR. ELECTROLUX SHALL NOT BE LIABLE FOR CONSEQUENTIAL OR INCIDENTAL DAMAGES SUCH AS PROPERTY DAMAGE AND INCIDENTAL EXPENSES RESULTING FROM ANY BREACH OF THIS WRITTEN LIMITED WARRANTY OR ANY IMPLIED WARRANTY. SOME STATES AND PROVINCES DO NOT ALLOW THE EXCLUSION OR LIMITATION OF INCIDENTAL OR CONSEQUENTIAL DAMAGES, OR LIMITATIONS ON THE DURATION OF IMPLIED WARRANTIES, SO THESE LIMITATIONS OR EXCLUSIONS MAY NOT APPLY TO YOU. THIS WRITTEN WARRANTY GIVES YOU SPECIFIC LEGAL RIGHTS. YOU MAY ALSO HAVE OTHER RIGHTS THAT VARY FROM STATE TO STATE.

If You Need Service

Keep your receipt, delivery slip, or some other appropriate payment record to establish the warranty period should service be required. If service is performed, it is in your best interest to obtain and keep all receipts. Service under this warranty must be obtained by contacting Electrolux at the addresses or phone numbers below.

This warranty only applies in the USA and Canada. In the USA, your appliance is warranted by Electrolux Major Appliances North America, a division of Electrolux Home Products, Inc. In Canada, your appliance is warranted by Electrolux Canada Corp. Electrolux authorizes no person to change or add to any obligations under this warranty. Obligations for service and parts under this warranty must be performed by Electrolux or an authorized service company. Product features or specifications as described or illustrated are subject to change without notice.

USA
1.800.944.9044
Electrolux Home Products, Inc.
10200 David Taylor Drive
Charlotte, NC 28262



Canada
1.800.265.8352
Electrolux Canada Corp.
5855 Terry Fox Way
Mississauga, Ontario, Canada
L5V 3E4