

SERVICE DATA SHEET

Gas Ranges with ES 330/335/340/345 Electronic Oven Controls

NOTICE - This service data sheet is intended for use by persons having electrical and mechanical training and a level of knowledge of these subjects generally considered acceptable in the appliance repair trade. The manufacturer cannot be responsible, nor assume any liability for injury or damage of any kind arising from the use of this data sheet.

SAFE SERVICING PRACTICES

To avoid the possibility of personal injury and/or property damage, it is important that safe servicing practices be observed. The following are examples, but without limitation, of such practices.

1. Before servicing or moving an appliance remove power cord from electrical outlet, trip circuit breaker to OFF, or remove fuse.
2. Never interfere with the proper installation of any safety device.
3. **GROUNDING:** The standard color coding for safety ground wires is **GREEN** or **GREEN WITH YELLOW STRIPES**. Ground leads are not to be used as current carrying conductors. **It is extremely important that the service technician reestablish all safety grounds prior to completion of service. Failure to do so will create a potential safety hazard.**

4. Prior to returning the product to service, ensure that:
 - All electric connections are correct and secure.
 - All electrical leads are properly dressed and secured away from sharp edges, high-temperature components, and moving parts.
 - All uninsulated electrical terminals, connectors, heaters, etc. are adequately spaced away from all metal parts and panels.
 - All safety grounds (both internal and external) are correctly and securely reassembled.

OVEN CALIBRATION

Set the electronic oven control for normal baking at 350°F. Obtain an average oven temperature after a minimum of 5 cycles. Press **STOP/CLEAR** to end bake mode.

TEMPERATURE ADJUSTMENT

1. Set EOC to bake at 550°F.
2. Within 5 seconds of setting 550°F, press and hold the bake pad for approximately 15 seconds until a single beep is heard (longer may cause **F11** shorted keypad alarm).
3. Calibration offset should appear in the display.
4. Use the slew keys to adjust the oven temperature up or down 35°F in 5°F increments.
5. Once the desired (-35° to 35°) offset has been applied, press **STOP/CLEAR**.

Note: Changing calibration affects normal Bake mode. The adjustments made will not change the Self-Cleaning cycle temperature.

ELECTRONIC OVEN CONTROL (REAR VIEW)

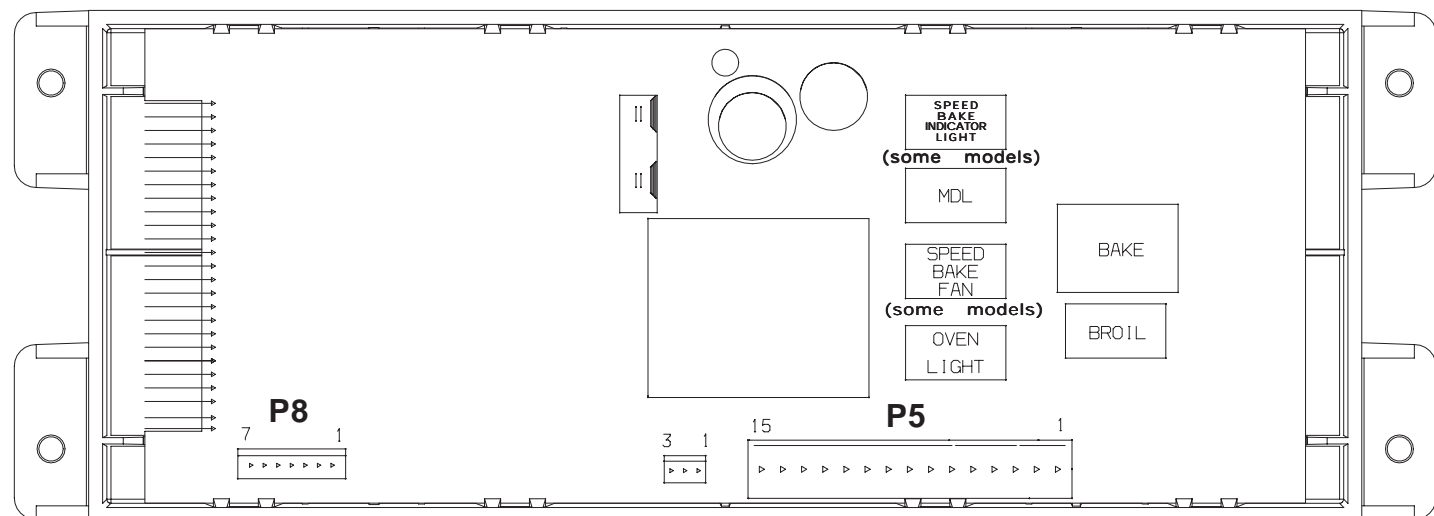

RESISTANCE TEMPERATURE DETECTOR

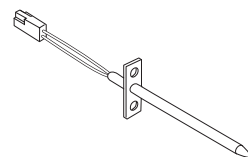

RTD SCALE	
Temperature (°F)	Resistance (ohms)
32 ± 1.9	1000 ± 4.0
75 ± 2.5	1091 ± 5.3
250 ± 4.4	1453 ± 8.9
350 ± 5.4	1654 ± 10.8
450 ± 6.9	1852 ± 13.5
550 ± 8.2	2047 ± 15.8
650 ± 9.6	2237 ± 18.5
900 ± 13.6	2697 ± 24.4

ELECTRONIC OVEN CONTROL FAULT CODE DESCRIPTIONS

Fault Code	Likely Failure Condition/Cause	Suggested Corrective Action
F10	Runaway Temperature.	1. (F10 only) Check RTD Sensor Probe & replace if necessary. If oven is overheating, disconnect power. If oven continues to overheat when the power is reapplied, replace EOC. Severe overheating may require the entire oven to be replaced should damage be extensive. 2. (F11, 12 & 13) Disconnect power, wait 30 seconds and reapply power. 3. (F11, 12 & 13) If fault returns upon power-up, replace EOC.
F11	Shorted Keypad.	
F12	Bad Micro Identification.	
F13	Bad EEPROM Identification/Checksum error.	
F30	Open probe connection.	1. (F30 or F31) Check resistance at room temperature & compare to RTD Sensor resistance chart. If resistance does not match the RTD chart replace RTD Sensor Probe. Check Sensor wiring harness between EOC & Sensor Probe connector. 2. (F30 or F31) Check resistance at room temperature, if less than 500 ohms, replace RTD Sensor Probe. Check for shorted Sensor Probe harness between EOC & Probe connector.
F31	Shorted Probe connection.	
F90	Maximum oven door unlock time exceeded.	1. (F90, 91, 92, 93 & 94) Check the wiring between EOC & Lock Motor Micro Switch. 2. (F90, 91, 92, 93 & 94) Replace the Motor Door Latch assembly if necessary. 3. (F90, 91, 92, 93 & 94) Check for binding of the Latch Cam, Lock Motor Rod & Lock Motor Cam. 4. (F90, 91, 92, 93 & 94) Check to see if Lock Motor Coil is open. If open, replace Lock Motor Assembly. 5. (F90, 91, 92, 93 & 94) Lock Motor continuously runs - if Micro Switch is open, replace Lock Motor Assembly. 6. (F92, 93 & 94) Check oven door Light Switch - if open, replace Switch. 7. If all situations above do not solve problem, replace EOC.
F91	Maximum oven door unlock attempts exceeded.	
F92	Maximum oven door open time exceeded.	
F93	Maximum oven door lock time exceeded.	
F94	Maximum oven door lock attempts exceeded.	

REMOVING & REPLACING WARMER DRAWER (some models)



WARNING Electrical Shock Hazard can occur and result in serious injury or death. Disconnect appliance from electric power before cleaning and servicing the Warmer Drawer.

To Remove Warmer Drawer:

1. **CAUTION** Turn power off before removing the Warmer Drawer.
2. Open the drawer to the fully opened position.
3. Locate glide lever on each side of drawer, pull up on the left glide lever and push down on the right glide lever (see Figure 1).
4. Pull the drawer away from the range.

To Replace Warmer Drawer:

1. Pull the bearing glides to the front of the chassis glide (see Fig. 2).
2. Align the glide on each side of the drawer with the glide slots on the range.
3. Push the drawer into the range until levers "click" (approximately 2"). Pull the drawer open again to seat bearing glides into position. **If you do not hear the levers "click" or the bearing glides do not feel seated remove the drawer and repeat steps 1 thru 3.** This will minimize possible damage to the bearing glides.

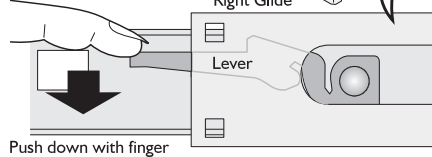
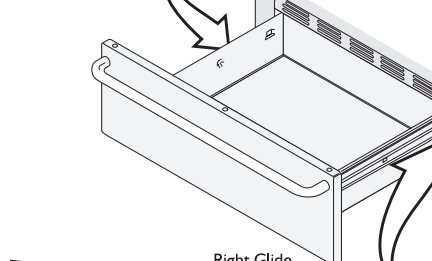
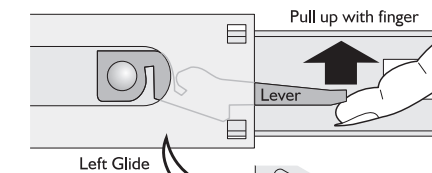

Fig. 1

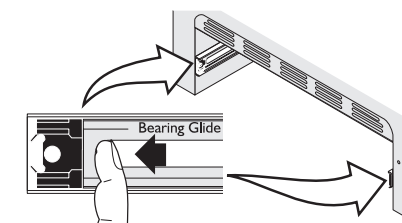

Fig. 2

IMPORTANT
DO NOT REMOVE THIS BAG
OR DESTROY THE CONTENTS
WIRING DIAGRAMS AND SERVICE
INFORMATION ENCLOSED
REPLACE CONTENTS IN BAG

CIRCUIT ANALYSIS MATRIX

	EOC Relays					Door Switch COM-NO	Warmer Drawer Lock Switch (Motor Door Latch)
	L1 to Bake	L1 to Broil	L1 to Motor Door Latch	L1 to Conv/Speed Bake Fan	L1 to Conv/Speed Bake Indicator Light		
Bake/Time Bake	X	X*					X
Conv/Speed Bake	X	X*		X	X		X
Broil		X					X
Clean	X						
Unlocked							X
Locking			X				X
Locked							
Unlocking			X				X
Door Open							
Door Closed						X	

Note: X=Check listed circuits. *=Alternates with Bake element.

ELECTRONIC OVEN CONTROL (EOC) TROUBLESHOOTING GUIDE

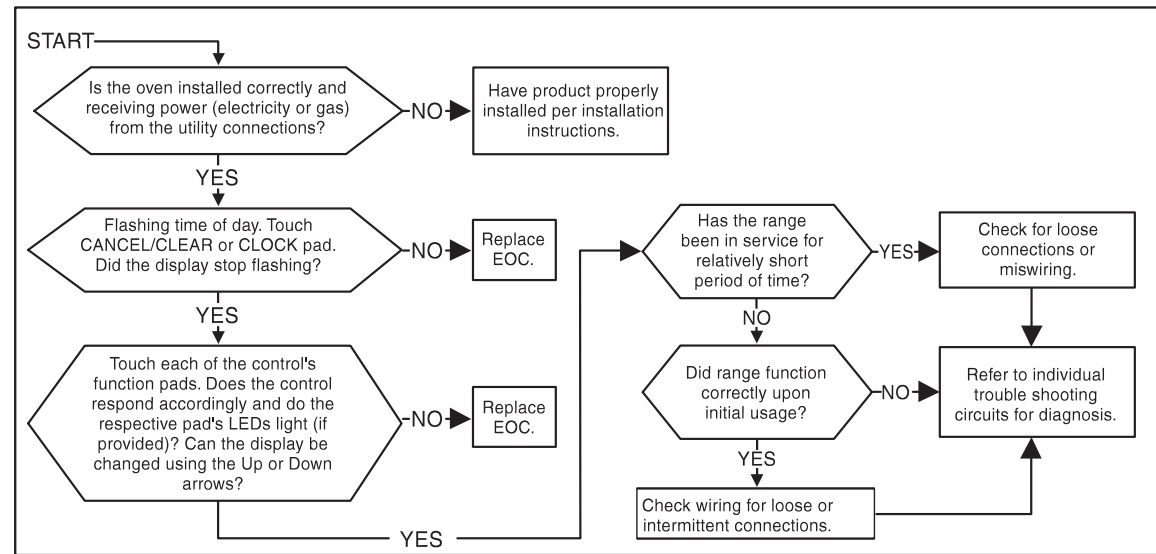

E.O.C. CONTROL CONNECTIONS

P5 CONNECTION

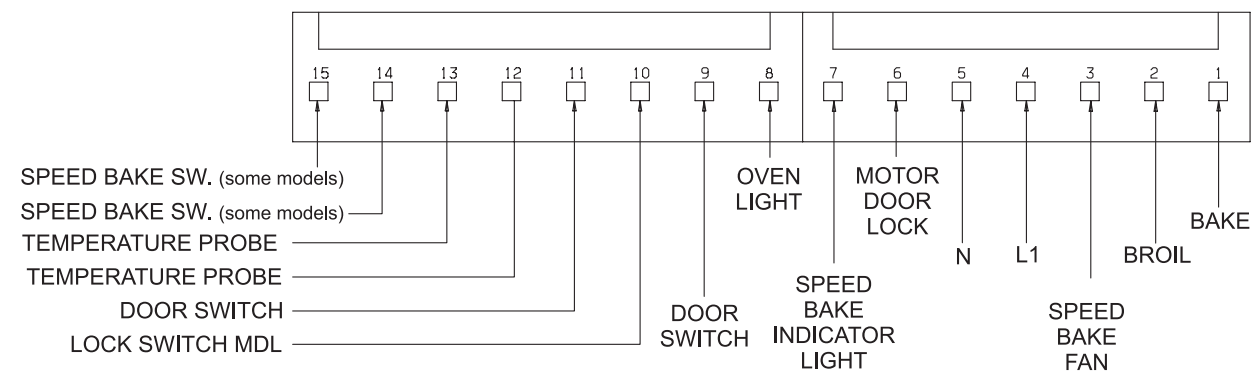

GENERAL TROUBLESHOOTING SCHEMATIC

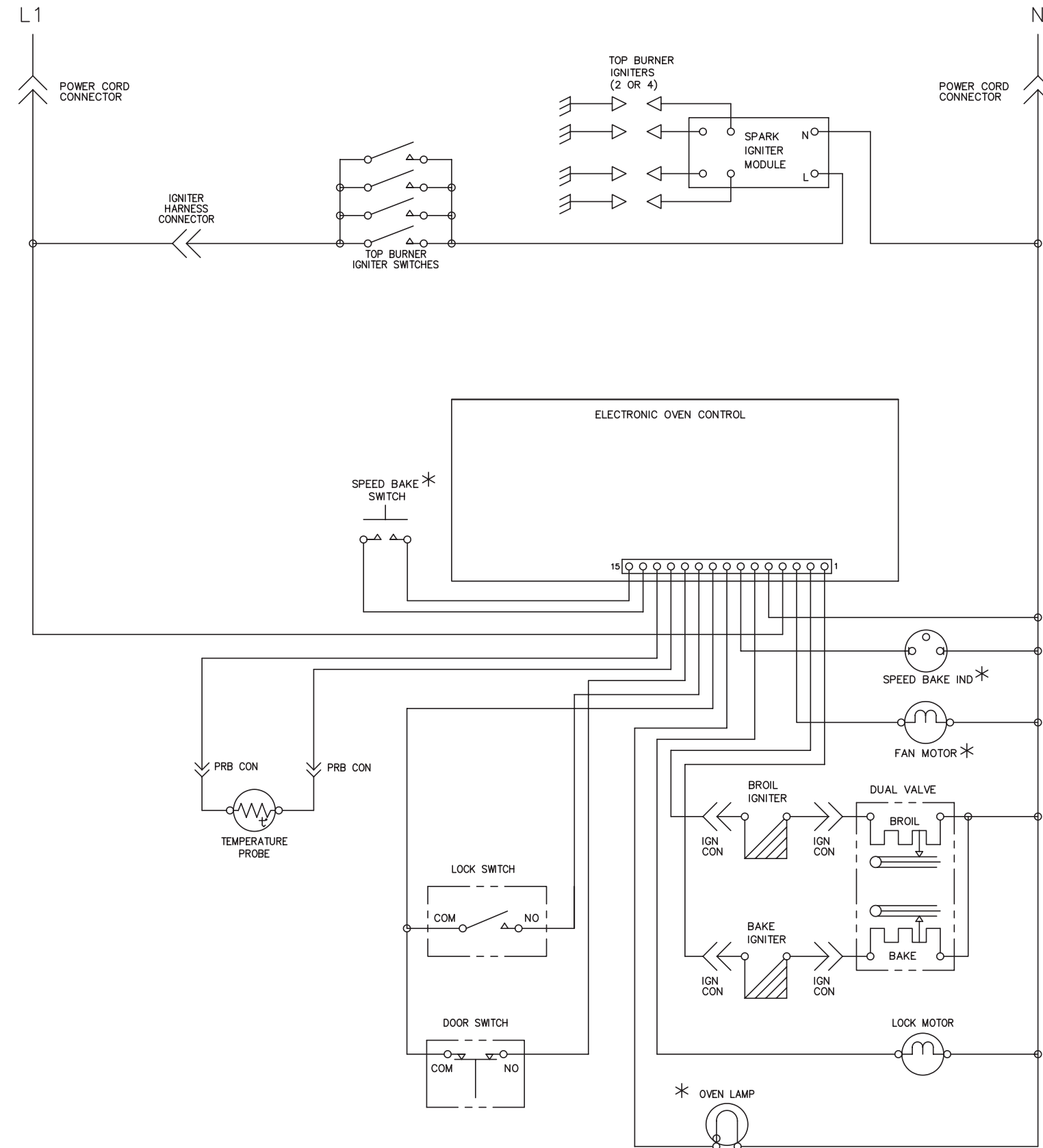

NOTES:

1. CIRCUIT SHOWN WITH ALL CONTROLS SET TO OFF, OVEN DOOR CLOSED AND UNLOCKED.
2. COMPONENTS WITH * DO NOT APPEAR ON ALL MODELS.