

FRIGIDAIRE

All about the

Use & Care

of your Wall Oven

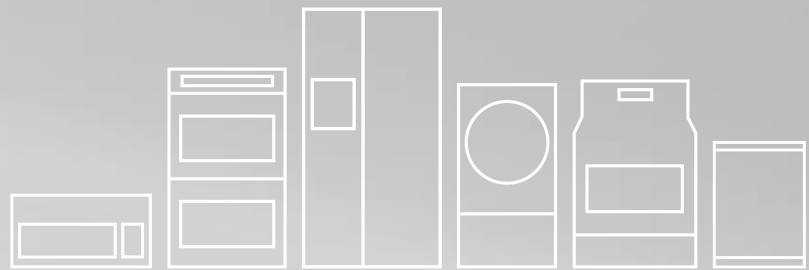

TABLE OF CONTENTS

Welcome & Congratulations	2	Adjusting the oven temperature	15
Important Safety Instructions.....	3	Care & Cleaning (chart)	16
Features at a Glance.....	6	Care & Cleaning	17
Before Setting Oven Controls	7	Before You Call	18
Setting Oven Controls.....	8	Major Appliance Warranty	20
Self-Cleaning.....	14		

WELCOME & CONGRATULATIONS

Product Registration Register Your Product

The **PRODUCT REGISTRATION CARD** should be filled in completely, signed and returned to Electrolux Major Appliances.

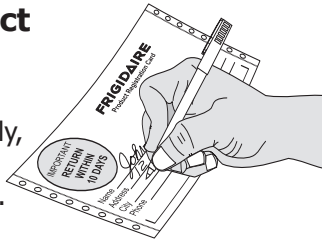

Congratulations on your purchase of a new appliance! At **Electrolux Major Appliances**, we are very proud of our product and are completely committed to providing you with the best service possible. Your satisfaction is our number one priority.

We know you'll enjoy your new appliance and **Thank You** for choosing our product. We hope you consider us for future purchases.

PLEASE CAREFULLY READ AND SAVE THESE INSTRUCTIONS

This Use & Care Manual contains general operating instructions for your appliance and feature information for several models. Your product **may not** have all the described features. The graphics shown are representative. The graphics on your appliance may not look exactly like those shown. These instructions are not meant to cover every possible condition and situation that may occur. Common sense and caution must be practiced when installing, operating and maintaining any appliance.

Serial Plate Location

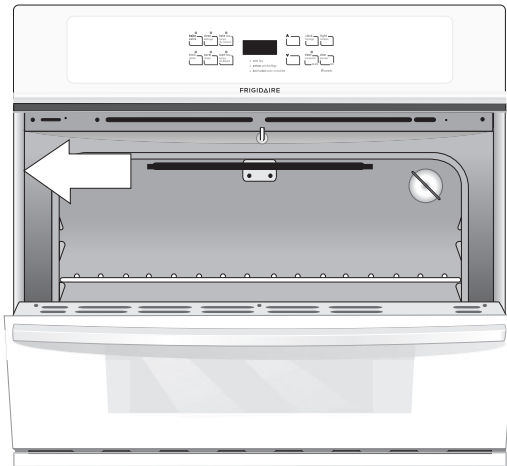

Please record your model and serial numbers below for future reference.

Model Number: _____

Serial Number: _____

Purchase Date: _____



NOTE

Please attach sales receipt here for future reference.

IMPORTANT SAFETY INSTRUCTIONS

Read all instructions before using this appliance.
Save these instructions for future reference.

DEFINITIONS

 This is the safety alert symbol. It is used to alert you to potential personal injury hazards. Obey all safety messages that follow this symbol to avoid possible injury or death.

WARNING

This symbol will help alert you to situations that may cause serious bodily harm, death or property damage.

CAUTION

This symbol will help alert you to situations that may cause bodily injury or property damage.

IMPORTANT

IMPORTANT indicates installation, operation or maintenance information which is important but not hazard-related.

- **Remove all tape and packaging wrap before using the appliance. Destroy the carton and plastic bags after unpacking the appliance.** Never allow children to play with packaging material. Do not remove the wiring label and other literature attached to the appliance. Do not remove model/serial number plate.
- **Proper Installation. Be sure your appliance is properly installed and grounded by a qualified technician in accordance with the National Electrical Code No. 70 - latest edition in the United States, or CSA C22.1, Part 1 in Canada, and local code requirements.** Install only per installation instructions provided in the literature package for this appliance.

Ask your dealer to recommend a qualified technician and an authorized repair service. Know how to disconnect the electrical power to the appliance at the circuit breaker or fuse box in case of an emergency.

CAUTION

Electronic controllers can be damaged by cold temperatures. When you use your appliance for the first time, or if it has not been used for a long period of time, make sure that it has been exposed to a temperature above 0°C/32°F for at least 3 hours before connecting it to the power supply.

WARNING



- All appliance can tip.
- Injury to persons could result.
- Install anti-tip bracket packed with your appliance.
- See Installation Instructions.



To reduce the risk of tipping, the appliance must be secured by properly installed anti-tip bracket provided with the unit. Refer to the Installation Instructions for proper anti-tip bracket installation.

- **User Servicing. Do not repair or replace any part of the appliance unless specifically recommended in the manuals.** All other servicing should be done only by a qualified technician to reduce the risk of personal injury and damage to the appliance.
- **Never modify or alter the construction of an appliance such as removal of panels, wire covers or any other permanent part of the appliance.**
- **Storage on Appliance. Flammable materials should not be stored near surface units.** This includes paper, plastic and cloth items, such as cookbooks, plasticware and towels, as well as flammable liquids. Do not store explosives, such as aerosol cans, on or near the appliance. Flammable materials may explode and result in fire or property damage.
- **Remove the oven door from any unused appliance if it is to be stored or discarded.**

WARNING

Stepping, leaning, sitting or pulling down on the door of this appliance can result in serious injuries and may also cause damage to the appliance. Do not allow children to climb or play around the appliance.

- **Storage in or on Appliance—Flammable materials should not be stored in an oven.** This includes paper, plastic and cloth items, such as cookbooks, plasticware and towels, as well as flammable liquids. Do not store explosives, such as aerosol cans, in or near the appliance.

WARNING

Do not use the oven for storage.

IMPORTANT SAFETY INSTRUCTIONS

CAUTION

Do not store items of interest to children in the cabinets above the appliance. Children climbing on the cooktop to reach items could be seriously injured.

- **Do not leave children alone. Children should not be left alone or unattended in the area where an appliance is in use.** They should never be allowed to sit or stand on any part of the appliance.
- **DO NOT TOUCH INTERIOR OVEN ELEMENTS OR INTERIOR SURFACES OF THE OVEN UNTIL THEY HAVE COOLED.** The oven heating elements may be hot even though the elements are dark in color. Areas near the elements may become hot enough to cause burns. During and after use, do not touch, or let clothing or other flammable materials touch these areas until they have had sufficient time to cool. Among these areas are the oven vent openings, the surfaces near these openings, oven door and window.
- **Wear Proper Apparel. Loose-fitting or hanging garments should never be worn while using the appliance.** Do not let clothing or other flammable materials contact hot surfaces.

WARNING

Never use your appliance for warming or heating the room.

- **Do Not Use Water or Flour on Grease Fires. Smother the fire with a pan lid, or use baking soda, a dry chemical or foam-type extinguisher.**
- **When heating fat or grease, watch it closely.** Fat or grease may catch fire if allowed to become too hot.
- **Use Only Dry Pot holders. Moist or damp pot holders on hot surfaces may result in burns from steam.** Do not let the pot holders touch hot surface units. Do not use a towel or other bulky cloth instead of a pot holder.
- **Do Not Heat Unopened Food Containers. Buildup of pressure may cause the container to burst and result in injury.**

IMPORTANT

Do not attempt to operate the appliance during a power failure. If the power fails, always turn off the unit. If the unit is not turned off and the power resumes, the appliance will not operate and an error message will be displayed.

IMPORTANT SAFETY INSTRUCTIONS FOR USING YOUR OVEN

- **Use Care When Opening an Oven Door**—Stand to the side of the appliance when opening the door of a hot oven. Let hot air or steam escape before you remove or replace food in the oven.
- **Keep Oven Vent Ducts Unobstructed.** The wall oven is vented at the center trim under the control panel. Touching the surfaces in this area when the oven is operating may cause severe burns. Also, do not place plastic or heat-sensitive items near the oven vent. These items could melt or ignite.
- **Placement of Oven Racks.** Always place oven racks in desired location while oven is cool. Remove all utensils from the rack before removing rack. If rack must be moved while oven is hot, use extreme caution. Use pot holders and grasp the rack with both hands to reposition. Do not let pot holders contact the hot oven element or interior of the oven.
- **Do not use a broiler pan without its insert.** Broiler pan and grid allow dripping fat to drain and be kept away from the high heat of the broiler.
- **Do not cover the broiler grid or oven bottom with aluminum foil.** Exposed fat and grease could ignite.
- **Do not touch a hot oven light bulb with a damp cloth.** Doing so could cause the bulb to break. Disconnect the appliance or shut off the power to the appliance before removing and replacing the bulb.
- **Protective liners**—Do not use aluminum foil to line the oven bottom. Only use aluminum foil as recommended in this manual. Improper installation of these liners may result in risk of electric shock, or fire.

IMPORTANT SAFETY INSTRUCTIONS

IMPORTANT SAFETY INSTRUCTIONS FOR CLEANING YOUR OVEN

- **Clean the appliance regularly to keep all parts free of grease that could catch fire.** Exhaust fan ventilation hoods and grease filters should be kept clean. Do not allow grease to accumulate. Greasy deposits in the fan could catch fire. Refer to the hood manufacturer's instructions for cleaning.
- **Cleaners/Aerosols**—Always follow the manufacturer's recommended directions for use. Be aware that excess residue from cleaners and aerosols may ignite causing damage and/or injury.
- **Clean in the self-cleaning cycle only the parts of the appliance listed in this Owner's Guide.** Before using the self-cleaning cycle of the appliance, remove all utensils stored in the appliance.
- **Do not clean the oven door gasket.** The door gasket is essential for a good seal. Care should be taken not to rub, damage or move the gasket.
- **Do not use oven cleaners.** No oven cleaner or oven liner protective coating of any kind should be used in or around any part of the appliance.



CAUTION

The health of some birds is extremely sensitive to the fumes given off during the self-clean cycle of any wall oven. Move birds to another well ventilated room.

Save these instructions for future reference.

FEATURES AT A GLANCE

Your Electric Wall-Oven Features

1. Electronic oven control with kitchen timer.
2. Oven vent.
3. Self-clean door latch.
4. Broil element.
5. Oven interior light with removable cover.
6. Self-clean oven interior.
7. Adjustable interior oven rack(s).
8. Large 1-piece oven door handle.
9. Full width oven door with window.
10. Bottom trim.

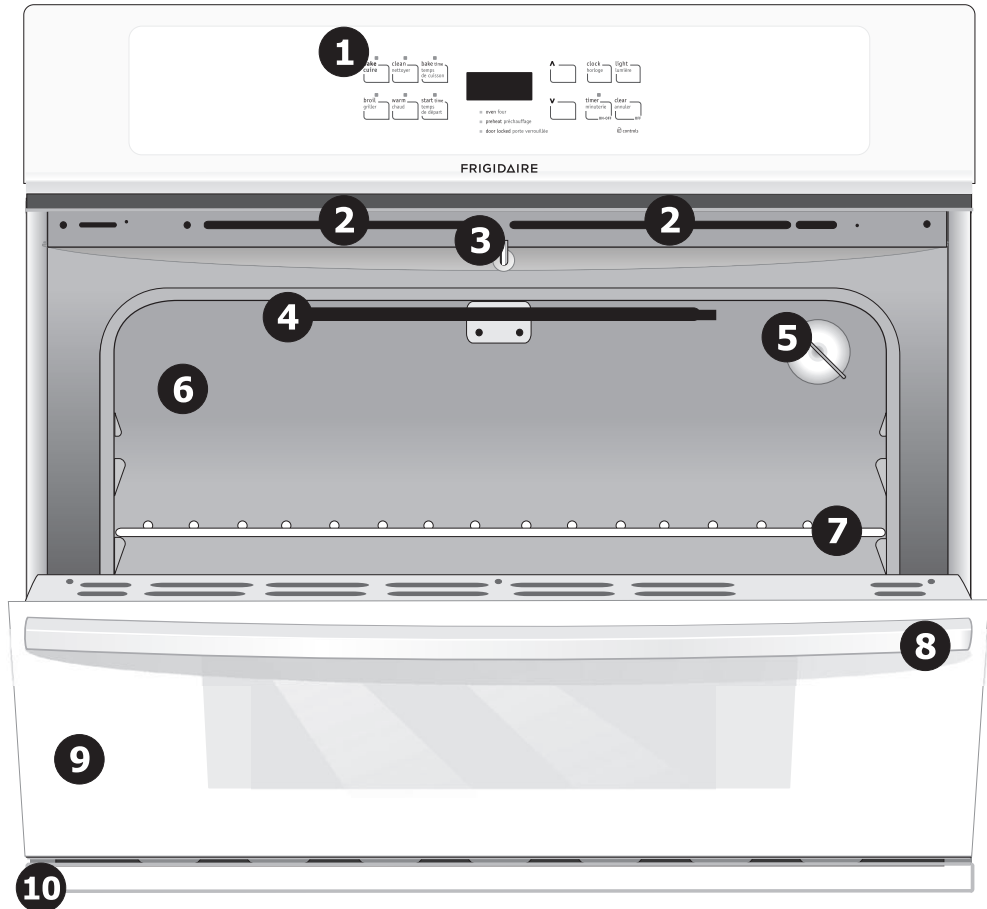

NOTE

The features shown for your appliance may vary according to model type & color.

BEFORE SETTING OVEN CONTROLS

Oven Vent Location

The oven is vented **at the center trim**. When the oven is on, warm air is released through the vent. This venting is necessary for proper air circulation in the oven and good baking results.

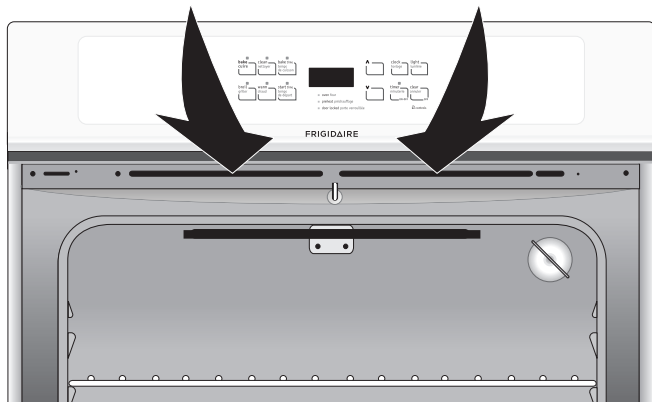

CAUTION

Some models are equipped with a blower which runs in baking and self-cleaning mode to keep all internal components at a cool temperature. The blower may keep running even if the oven has been turned off, until the components have cooled down.

Air Circulation in the Oven

If using 1 rack, place in center of oven. If using multiple racks, stagger cookware as shown.

For best air circulation and baking results allow 2-4" (5-10 cm) around the cookware for proper air circulation and be sure pans and cookware do not touch each other, the oven door, sides or back of the oven cavity. The hot air must circulate around the pans and cookware in the oven for even heat to reach around the food.

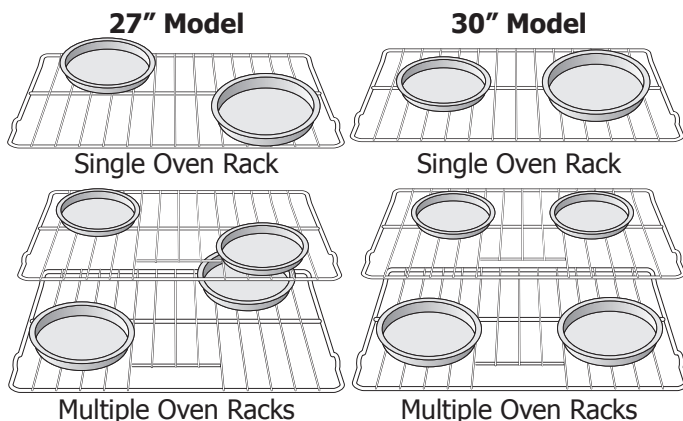

Arranging Oven Racks

ALWAYS ARRANGE OVEN RACKS WHEN THE OVEN IS COOL (PRIOR TO OPERATING THE OVEN). Always use oven mitts when using the oven.

To remove an oven rack, pull the rack forward until it stops. Lift up front of rack and slide out.

To replace an oven rack, fit the rack onto the guides on the oven walls. Tilt the front of the rack upward and slide the rack back into place.

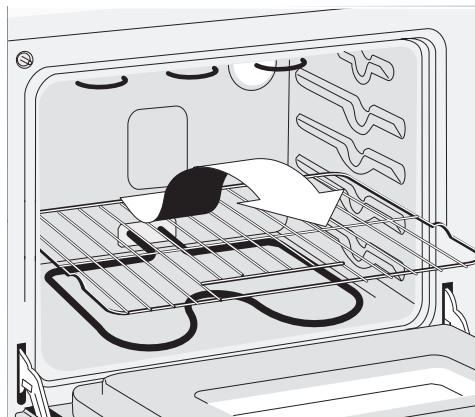

Recommended Rack Position

Food	Rack Position
Broiling meats, chicken or fish	3 or 4
Cookies, cakes, pies, biscuits & muffins	
Using a single rack	2 or 3
Using two racks	2 and 4
Frozen pies, angel food cake, yeast, bread, 1 or 2 casseroles, small cuts of meat or poultry	1 or 2
Turkey, roast or ham	1

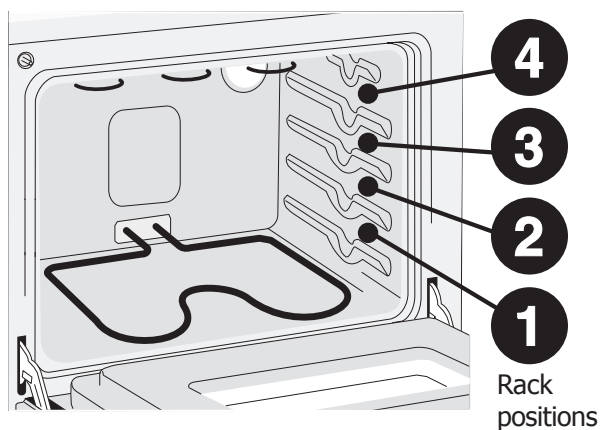

NOTE

Always use caution when removing food from the oven.

SETTING OVEN CONTROLS

Control Pad Features

READ THE INSTRUCTIONS CAREFULLY BEFORE USING THE OVEN. For satisfactory use of your oven, become familiar with the various features and functions of the oven as described below. **Detailed instructions for each feature and function follow later in this Use & Care Guide.** The graphics on your timer may not look exactly like the one shown. This doesn't change the way it operates.

NOTE

The oven function will not work if the time of day clock is not set.

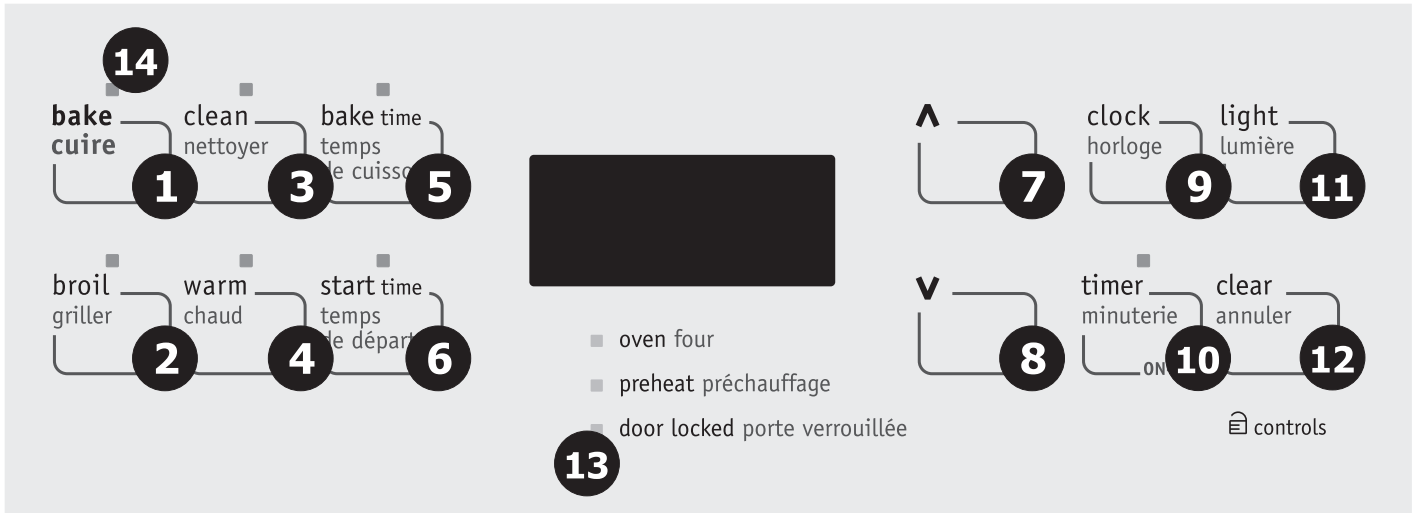

- 1. Bake Pad**— Used to enter the normal baking mode temperature.
- 2. Broil Pad**—Used to select the variable broil function.
- 3. Clean Pad**—Used to select the self-cleaning cycle.
- 4. Warm Pad**— Used to set the Warm feature.
- 5. Bake Time Pad**— Used to enter the length of the baking time.
- 6. Start Time Pad**— Used to set the desired start time for baking. Can be used with **BAKE TIME** to program a delayed bake cycle.
- 7. Up arrow pad**—Used along with the function pads to select oven temperature, time of day and minute timer.
- 8. Down arrow pad**—Used along with the function pads to select oven temperature, time of day and minute timer.
- 9. Clock Pad**— Used to set the time of day.

- 10. Timer On•Off Pad**— Used to set or cancel the minute timer. The minute timer does not start or stop cooking.
- 11. Light Pad**— Used to turn oven interior light ON and OFF.
- 12. Clear Pad**— Used to clear any function previously entered except the time of day and minute timer. Push **Clear pad** to stop cooking.
- 13. Oven, Preheat & Lock lights**— The “oven” light indicates that the oven is functioning. The “Preheat” light will glow when the oven is first set to operate, or if the desired temperature is reset higher than the actual oven temperature. The “Door Locked” light will flash until the door locks when the self-clean cycle is in use. It glows constantly after the door locks.
- 14. Feature indicator lights**— These light show which feature is in use.

NOTE

Push buttons or pads may be shaped differently.

To operate the interior oven light

The interior oven light(s) will automatically turn ON when the oven door is opened. Press the **light** pad to turn the interior light(s) ON and OFF whenever the door is closed.

The oven light is located at the upper left or right rear wall of the oven interior and is covered with a glass shield held by a wire holder. The glass shield must be in place whenever the oven is in use. To change the interior oven light, see changing the Oven Light.

SETTING OVEN CONTROLS

For a silent control panel

When choosing a function, a beep will be heard each time a pad is pushed. If desired, the controls can be programmed for silent operation.

To tell if your oven is set for normal or silent operation push and hold **Start time** pad for 7 seconds. "- -" or "SP" appears in the display. Within 5 seconds, press the **Up** or **Down arrow** pad to switch between normal sound operation and silent operation mode. The display will show either "- -" or "SP". Wait 5 seconds to return to normal operating mode.

NOTE

If "SP" appears, the control will operate with normal sounds and beeps. If "- -" appears, the control is in the silent operation mode.

Temperature Conversion (Fahrenheit/Celsius)

The electronic oven control is set to operate in °F (Fahrenheit) when shipped from the factory. The oven can be programmed for any temperature from 170°F to 550°F (77°C to 288°C).

To change the temperature to °C (Celsius) or from °C to °F (control should not be in a Bake or Clean mode):

1. Press and hold **Broil** pad for 7 seconds until °F or °C appears in the display.
2. Press the **Up** or **Down arrow** pad to change °F to °C or °C to °F.
3. Wait 5 seconds to accept the changes or press **Clear** pad to accept the changes.

Changing between 12 or 24 Hour Time of Day Display

1. Press and hold the **Clock** pad for 7 seconds. After 7 seconds, "12Hr" or "24Hr" will appear in the display and the control will beep once.
2. Press the **Up** or **Down arrow** pad to switch between the 12 and 24 hour time of day display. The display will show either "12Hr" or "24Hr".
3. Wait 5 seconds or press the **Clear** pad to return to the time of day display.
4. Reset the correct time as described in **To set the Clock** above. Please note that if the 24 hour time of day mode was chosen, the clock will now display time from 0:00 through 23:59 hours.

To set the Clock

NOTE

The time of day must first be set in order to operate the oven.

When the range is first plugged in, or when the power supply to the appliance has been interrupted, the display will flash "12:00".

1. Press the **Clock** pad once (do not hold pad down).
2. Within 5 seconds, push and hold the **Up** or **Down arrow** pad until the correct time of day appears in the display.
3. Press the **Clock** pad to accept the new time of day. If the **Clock** pad is not pressed, the timer will return automatically to the new time of day after 7 seconds.

NOTE

The clock cannot be changed while the oven is in used.

To Set the Minute Timer

1. Press the **Timer On•Off** pad.
2. Press the **Up arrow** pad to increase or **Down arrow** pad to decrease the time in one minute increments. The timer can be set for any amount of time from 1 minute to 11 hours and 59 minutes.
3. The display shows the timer count down in minutes if more than 1 hour remains. When less than 1 hour remains, the display will count down in seconds.
4. When the set time has run out, the timer will beep 3 times. It will continue to beep 3 times every 8 seconds until the **Timer On•Off** pad is pressed.

NOTE

- The indicator light located above the **Timer On•Off** pad will glow while the minute timer is active.
- The minute timer does not start or stop cooking. It serves as an extra timer in the kitchen that will beep when the set time has run out. The minute timer can be used alone or during any of the other oven functions. When the minute timer is in use with any other mode, the minute timer will be shown in the display. To view other functions, press the function pad for that mode.

To Cancel the Minute Timer before the set time has run out: Press the **Timer On•Off** pad.

SETTING OVEN CONTROLS

To Set Control for Continuous Bake or 12 Hour Energy Saving

The oven control has a built-in 12 Hour Energy Saving feature that will shut off the oven if the control is left on for more than 11 hours and 59 minutes. The oven can be programmed to override this feature for continuous baking.

To set control for continuous baking:

1. Press and hold the **Timer On•Off** pad for 7 seconds until a tone is heard.
2. Within 5 seconds, press the **Up** or **Down arrow** pad to switch between Continuous Bake and 12 Hour Energy Saving mode. The display will show either “— hr” or “12hr”.
If “- - hr” appears, the oven will be set to continuous baking. If “12hr ” appears, the oven is set to 12 hour energy saving mode.
3. Wait 5 seconds or press the **Clear** pad to accept the changes.

To Set Control for Oven Lockout

The control can be programmed to lock the oven door and/or lock the oven control pads. The Oven Lockout feature prevents the oven from being accidentally turned on. It does not disable the clock, minute timer or the interior oven light.

To Set Control for Oven Lockout feature:

1. Press the **Clear off** pad and hold for 3 seconds. The “Door Locked” indicator light will flash and the motor driven door lock will begin to close automatically.
DO NOT open the oven door while the indicator light is flashing. Allow about 15 seconds for the oven door to lock. Once the oven door is locked, “Loc” will appear in display.
2. To cancel the Oven lockout feature, press the **Clear** pad and hold for 3 seconds. The control will unlock the oven door and resume normal operation.

To Set or Change the Temperature for Normal Baking

NOTE

The time of day must first be set in order to operate the oven.

The oven can be programmed to bake at any temperature from 170°F to 550°F (77°C to 288°C).

To Set the Controls for Normal Baking:

1. Press the **Bake** pad. “— — °” appears in the display.
2. Within 5 seconds, Press the **Up** or **Down arrow** pad. The display will show “350°F (177°C).” By holding the **Up** or **Down arrow** pad, the temperature can then be adjusted in 5°F (1°C if control is set to display Celsius) increments.

3. 8 seconds after the **Up** or **Down arrow** pad is released, the oven will begin heating to the selected temperature. When the displayed temperature reaches the desired baking temperature, the preheat indicator light will turn OFF and the oven control will beep.
4. To cancel the baking function, press the **Clear** pad.

To Change the Oven Temperature after Baking has Started: Press the **Up** or **Down arrow** pad to increase or decrease the set temperature.

Setting Broil

Broiling is a method of cooking tender cuts of meat by direct heat under the broil element of the oven. A beep lets you know when the broil temperature is reached. Be sure you center the broiler pan directly under the broil element for best results.

Arrange oven rack while oven is still cool. Position the rack as needed. The broiler pan and its insert allow dripping grease to drain and be kept away from high heat of the broiler. **DO NOT** use the pan without its insert. **DO NOT** cover the insert with foil. The exposed grease could ignite.



CAUTION

Should an oven fire occur, close the oven door and turn off the oven. If the fire continues, throw baking soda on the fire or use a fire extinguisher. DO NOT put water or flour on the fire. Flour may be explosive and water can cause a grease fire to spread and cause personal injury.

Broiling Tips:

- For optimum browning, preheat the broil element for 5 minutes.
- Broil one side until the food is browned; turn and cook on the second side. Season and serve.
- Always pull the rack out to the “stop” position before turning or removing food.
- Always use the broiler pan and its cover when broiling. It allows the dripping grease to be kept away from the high heat of the broil element (see Figure 1).
- For best broiling results, broil with the oven door in the broil stop position (see Figure 2).
- If using a Searing Grill (available by mail order), preheat the grill for 5 to 10 minutes before placing your meat.
- **DO NOT** use the broil pan without the insert. **DO NOT cover the broil pan insert with foil.** The exposed grease could catch fire.

SETTING OVEN CONTROLS

Accessories available via the enclosed brochure:

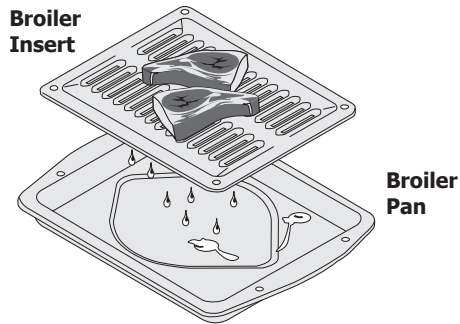
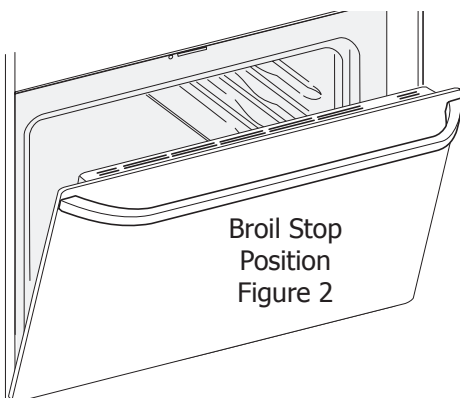

Figure 1

To set for broiling:

1. Arrange the oven rack while oven is still cool.
2. Press the **Broil** pad. "- -" will appear in the display.
3. Press the **Up** or **Down arrow** pad until the desired broil setting level appears in the display. Press the **Up arrow** pad for **HI** broil or the **Down arrow** pad for **LO** broil. Most foods may be broiled at the **HI** broil setting. Select the **LO** broil setting to avoid excess browning or drying of foods that should be cooked to the well-done stage.
4. Place the insert on the broiler pan, then place the food on the insert. **DO NOT** use the pan without the insert or cover the insert with **aluminum foil**. The exposed grease could ignite.
5. Place the pan on the oven rack. **Open the oven door to the broil stop position when broiling (Figure 2).**
6. Broil on one side until food is browned. Turn and broil food on 2nd side.
Note: Always pull the rack out to the stop position before turning or removing food.
7. When broiling is finished, press the **Clear** pad.



To Set the Timed Bake and Delay Start Features

The **Bake time** and **Start time** pads operate the features that will turn the oven ON and OFF at the times you select in advance. The oven can be programmed to start immediately and shut off automatically (Timed Bake) or to begin baking at a later time with a delayed start time (Delay Start).

NOTE

During Timed Bake the preheat indicator light will function during the preheat operation.

To Program the Oven to Begin Baking Immediately and To Shut Off Automatically (Timed Bake):

1. Be sure that the clock shows the correct time of day.
2. Place the food in the oven.
3. Press the **Bake** pad. "— — °" appears in the display.
4. Within 5 seconds, press the **Up** or **Down arrow** pad. The display will show "350°F (177°C)". By holding the **Up** or **Down arrow** pad, the temperature can then be adjusted in 5°F increments (1° if the control is set to display Celsius).
5. Wait 8 seconds to accept the temperature.
6. Press the **Bake time** pad. "0:00" will flash in the display (MIN:SEC) and (HR:MIN) if programmed for more than 60 minutes.
7. Press the **Up** or **Down arrow** pad until the desired baking time appears in the display.
8. The oven will turn ON and begin heating.

NOTE

When the control is set for this function the oven temperature will be displayed. To see the cook time remaining press the **Bake time** pad and to see the time of day press the **Clock** pad.

To Program Oven for a Delayed Start Time and to Shut-Off Automatically (Delayed Start Bake):

1. Be sure that the clock shows the correct time of day.
2. Place the food in the oven.
3. Press the **Bake** pad. "— — °" appears in the display.
4. Within 5 seconds, press the **Up** or **Down arrow** pad. The display will show "350°F (177°C)." By holding the **Up** or **Down arrow** pad, the temperature can then be adjusted in 5°F increments (1° if the control is set to display Celsius).
5. Wait 8 seconds to accept the temperature.
6. Press the **Bake time** pad. "0:00" will flash in the display (MIN:SEC) and (HR:MIN) if programmed for more than 60 minutes.

SETTING OVEN CONTROLS

7. Press the **Up** or **Down arrow** pad until the desired baking time appears.
8. Wait 5 seconds for the control to accept the time.
9. Press the **Start time** pad. The earliest possible start time will appear in the display.
10. Press the **Up** or **Down arrow** pad until the desired start time appears in the display and wait 7 seconds to accept.
11. Once the controls are set, the control calculates the time when baking will start and stop.
12. The oven will turn ON at the delayed start time and begin heating.

NOTE

When the control is set for a delayed time bake the time of day is displayed until the delayed time bake is reached. When the oven will turn on, the oven temperature will be displayed. To see the cook time remaining press the **Bake time** pad and to see the time of day press the **Clock** pad.

When the Set Bake Time Runs Out:

1. "END" will appear in the display window and the oven will shut off automatically.
2. The control will beep 3 times every 25 seconds until the **Clear** pad is pressed.

To Change the Oven Temperature or Bake Time after Baking has Started:

1. Press the function pad you want to change.
2. Press the **Up** or **Down arrow** pad to adjust the setting.

CAUTION

Use caution with the Timed Bake and Delayed Start features. Foods that can easily spoil such as milk, eggs, fish, meat or poultry, should be chilled in the refrigerator first. Even when chilled, they should not stand in the oven for more than 1 hour before cooking begins, and should be removed promptly when cooking is completed.

Setting the Keep Warm Feature

The **Keep warm** pad turns ON the Keep Warm feature and will maintain an oven temperature of 170° F (77°C). The **Warm** feature will keep oven baked foods warm for serving up to 3 hours after cooking has finished. After 3 hours the Keep Warm feature will shut the oven OFF automatically. The Keep Warm feature may be used without any other cooking operations or can be used after cooking has finished using **Bake time** or **Delayed timed bake**.

To set Warm:

1. Arrange the interior oven racks and place baked food in the oven.
2. Press the **Warm** pad. "- -" will appear in the display and the Keep Warm indicator light above the pad will turn ON.

NOTE

If no further pads are touched within 6 seconds the request to turn ON Keep Warm will be cleared.

3. Press the **Up** or **Down arrow** pad to start. "Hld" will be displayed.
4. To turn Keep Warm OFF at any time press the **Clear** or **Warm** pad. The Keep Warm indicator light above the pad will turn OFF.

To set Keep Warm to turn ON automatically:

1. Arrange the interior oven racks and place food in the oven. Set the oven properly for **Timed bake** or **Delayed timed Bake**.
2. Press the **Warm** pad. "- -" will appear in the display and the Keep Warm indicator light above the pad will turn ON.
3. Press the **Up** or **Down arrow** pad to start. Keep Warm is set to turn ON automatically after Timed Bake or Delayed Start Bake has finished.
4. To turn Keep Warm OFF at any time press the **Clear** pad. The Keep Warm indicator light above the pad will turn OFF.

SETTING OVEN CONTROLS

To Set the Sabbath Feature (for use on the Jewish Sabbath & Holidays)

The **Bake time** and **Start time** pads are used to set the Sabbath feature. The Sabbath feature may only be used with the **Bake** pad. The oven temperature may be set higher or lower after setting the Sabbath feature (the oven temperature adjustment feature should be used only during Jewish Holidays), however the display will not visibly show or provide any audible tones indicating whether the change occurred correctly. Once the oven is properly set using Bake with the Sabbath feature active, the oven will remain continuously ON until cancelled. This will override the factory preset 12-Hour Energy Saving feature.

If the oven light will be needed during the Sabbath, press the **Oven light** pad before activating the Sabbath feature. Once the oven light is turned ON and the Sabbath feature is active, the oven light will remain ON until the Sabbath feature is turned OFF. If the oven light needs to be OFF, be sure to turn the oven light OFF before activating the Sabbath feature.

IMPORTANT NOTES: It is not advised to attempt to activate any other program feature other than **Bake** while the Sabbath feature is active. ONLY the following key pads will function after setting the Sabbath feature; **Up** or **Down arrow**, **Bake** & **Clear off**. **ALL OTHER KEYPADS** will not function once the Sabbath feature is properly activated.

To Program the Oven to Begin Baking Immediately & activate the Sabbath feature:

1. Be sure that the clock is set with the correct time of day.
2. Place the food in the oven.
3. Press the **Bake** pad. " — — — °" appears in the display.
4. Within 5 seconds, press the **Up** or **Down arrow** pad. The display will show "350°F (177°C)." By holding the **Up** or **Down arrow** pad, the temperature can then be adjusted in 5°F increments (1°C if the control is set to display Celsius).
5. If you desire to set the oven control for a **Timed bake** or a **Delayed start** do so at this time. If not, skip this step and continue to step 6. Refer to the **Bake time** (complete steps 6-7) / **Start time** (complete steps 6-10) section for complete instructions. Remember the oven will shut down after using **Bake time** or **Start time** and therefore may only be used once during the Sabbath/Jewish Holidays. The maximum **Start time** Bake time is 11 hours & 59 minutes.
6. The oven will turn ON and begin heating.

7. Press and hold both the **Bake time** and **Start time** pads for at least 3 seconds. **SAb** will appear in the display. Once **SAb** appears in the display the oven control will no longer beep or display any further changes and the oven is properly set for the Sabbath feature.

NOTE

You may change the oven temperature once baking has started by pressing the **Up** or **Down arrow** (for Jewish Holidays only). The oven temperature will be adjusted in 5°F increments with each press of these pads (1°C if the control is set to display Celsius). Remember that **the oven control will no longer beep or display any further changes** once the oven is set for the Sabbath feature.

8. The oven may be turned OFF at any time by first pressing the **Clear** pad (this will turn the oven OFF only). To turn OFF the Sabbath feature press and hold both the **Bake Time** and **Start Time** pads for at least 3 seconds. **SAb** will disappear from the display.

Should you experience a power failure or interruption, the oven will shut off. When power is returned the oven will not turn back on automatically. The oven will remember that it is set for the Sabbath and the food may be safely removed from the oven while still in the Sabbath feature, however the oven cannot be turned back on until after the Sabbath. After the Sabbath observance turn OFF the Sabbath feature. Press and hold both the **Bake Time** and **Start Time** pads for at least 3 seconds. **SAb** will disappear from the display and the oven may be used with all normal functions. For further assistance, guidelines for proper usage, and a complete list of models with the Sabbath feature, please visit the web at <http://www.star-k.org>.

SELF-CLEANING

Self-Cleaning

A self-cleaning oven cleans itself with high temperatures (well above normal cooking temperatures) which eliminate soils completely or reduces them to a fine powdered ash you can wipe away with a damp cloth.

➔ IMPORTANT

Adhere to the following cleaning precautions:

- **DO NOT** use oven cleaners or oven protective coatings in or around any part of the oven interior.
- **DO NOT** clean the oven door gasket. The woven material of the oven door gasket is essential for a good seal. Care should be taken not to rub, damage or remove the gasket.
- **DO NOT** use any cleaning materials on the oven door gasket. Doing so could cause damage.
- **Remove the broiler pan and insert, all utensils and ANY ALUMINUM FOIL. These items cannot withstand high cleaning temperatures and will melt.**
- **Completely remove ALL OVEN RACKS and ANY ACCESSORIES. If the oven racks are not removed, they will lose their special coating properties and will no longer slide in and out of the oven cavity effortlessly.**
- **Remove any excessive spillovers** in the oven cavity **before** starting the Self-Cleaning cycle. To clean, use hot, soapy water and a cloth. Large spillovers can cause heavy smoke or fire when subjected to high temperatures. **DO NOT** allow food spills with a high sugar or acid content (such as milk, tomatoes, sauerkraut, fruit juices or pie filling) to remain on the surface as they may leave a dull spot even after cleaning.
- Clean any soil from the oven frame, the door liner outside the oven door gasket and the small area at the front center of the oven bottom. These areas heat sufficiently to burn soil on. Clean with soap and water.

What to Expect during Cleaning

While the oven is in operation, the oven heats to temperatures much higher than those used in normal cooking. Sounds of metal expansion and contraction are normal. Odor is also normal as the food soil is being removed. Smoke may appear through the oven vent.

If heavy spillovers are not wiped up before cleaning, they may flame and cause more smoke and odor than usual. This is normal and safe and should not cause alarm. If available, use an exhaust fan during the self-cleaning cycle.

⚠ CAUTION

To avoid possible burns use care when opening the oven door after the Self-Cleaning cycle. Stand to the side of the oven when opening the door to allow hot air or steam to escape.

During the Self-Cleaning cycle, the outside of the range can become very hot to the touch. **DO NOT** leave small children unattended near the appliance.

The health of some birds is extremely sensitive to the fumes given off during the Self-Cleaning cycle of any range. Move birds to another well-ventilated room.

DO NOT line the oven walls, racks, bottom or any other part of the range with **aluminum foil**. Doing so will destroy heat distribution, produce poor baking results and cause permanent damage to the oven interior (aluminum foil will melt to the interior surface of the oven).

DO NOT force the oven door open. This can damage the automatic door locking system. Use caution when opening the door after the Self-Cleaning cycle is completed. The oven may still be VERY HOT.

📌 NOTE

See additional cleaning information for the oven door in the **General Care & Cleaning** section.



Self-Clean Cycle

NOTE

The kitchen area should be well ventilated using an open window, ventilation fan or exhaust hood during the Self-Clean cycle. This will help eliminate the normal odors associated with the Self-cleaning cycles.

To Set the Controls for a Self-Clean or a Delayed Start Self-Clean:

NOTE

If you do not want to start a **Delayed** Self-Clean Cycle, skips steps 2 & 3.

1. Be sure the clock shows the correct time of day.
2. Press the **Start time** pad.
3. Press and hold the **Up arrow** pad to scroll to the time to start the delayed Self-Clean cycle. Release the pad when the desired time is displayed.
4. Press the **Clean** pad. "-" appears in the display.
5. Press the **Up arrow** pad once.
As soon as the controls are set, the motor driven lock will begin to close automatically and the "Door Locked" indicator light will flash. **DO NOT** open the oven door while the light is flashing (it takes about 15 seconds for the oven door to lock).

6. "**CLn**" will appear in the display during the Self-Clean cycle and the "Door Locked" light will glow until the Self-Cleaning cycle is complete or cancelled and the oven temperature has cooled.

When the Self-Clean or Speed Clean Cycle is Completed:

1. "**CLn**" will appear in the display and the "Door Locked" light will continue to glow.
2. Once the oven has cooled down for about 1 HOUR and the "Door Locked" light has gone out, the oven door can be opened.

NOTE

When the oven is cool, wipe away any residue or powdered ash with a damp cloth or paper towel.

Stopping or Interrupting a Self-Cleaning Cycle

If it becomes necessary to stop or interrupt a Self-Cleaning cycle:

1. Press the **Clear** pad.
2. Once the oven has cooled down for about 1 HOUR and the "Door Lock" light has gone out, the oven door can be opened.
3. Restart the Self-Clean cycle once all conditions have been corrected.

ADJUSTING THE OVEN TEMPERATURE

Your oven thermostat has been precisely set at the factory. This setting may differ from your previous oven, however, so your recipe times may not give you the results you expect. If you think that the oven is cooking too hot or cool for your recipe times, you can adjust the thermostat so that the oven cooks hotter or cooler than the temperature displayed.

To Adjust Oven Temperature:

1. Press and hold the **Bake** pad for 8 seconds. The display now indicates the amount of degrees offset between the original factory temperature setting and the current temperature setting. If the oven control has the original factory calibration, the display will read "0".
2. The temperature can now be adjusted up or down 35°F or 19°C, in 1°F or 1°C steps by pushing and holding the **Up** or **Down arrow** pad. Adjust until the desired amount of degrees offset appears in the display. When lowering the oven temperature, a minus sign (-) will appear before the number to indicate that the oven will be cooler by the displayed amount of degrees.
3. When you have made the desired adjustment, wait 5 seconds or press **Clear** to accept the change.

NOTE

The oven temperature adjustments made with this feature will not change the Self-Clean cycle temperature.

CARE & CLEANING

Cleaning Various Parts of Your Range

Before cleaning any part of the range, be sure all controls are turned OFF and the range is COOL. REMOVE SPILLOVERS AND HEAVY SOILING AS SOON AS POSSIBLE. REGULAR CLEANING WILL REDUCE THE NUMBER OF MAJOR CLEANING LATER.

SURFACE TYPE	RECOMMENDATION
<ul style="list-style-type: none">● Aluminum & Vinyl	Use hot, soapy water and a cloth. Dry with a clean cloth.
<ul style="list-style-type: none">● Painted and plastic control knobs● Painted body parts● Painted decorative trims	Using a soft cloth, clean with mild dish detergent and water or a 50/50 solution of vinegar and water. Follow by rinsing the area with clean water; dry and polish with a soft cloth. Glass cleaners may be used if sprayed on a soft cloth first. DO NOT spray liquids directly on the control pad and display area. Do not use large amounts of water on the control panel - excess water on the control area may cause damage to the appliance. Do not use other liquid cleaners, abrasive cleaners, scouring pads, or paper towels - they will damage the finish. To remove control knobs, turn to the OFF position; grasp firmly and pull straight off the shaft. To replace knobs after cleaning, line up the flat sides of both the knob and the shaft; then push the knob into place.
<ul style="list-style-type: none">● Stainless Steel (some models) Oven Door and Decorative Bottom Trim	Clean stainless steel with hot, soapy water and a dishcloth. Rinse with clean water and a cloth. Do not use cleaners with high concentrations of chlorides or chlorines. Do not use harsh scrubbing cleaners. Only use kitchen cleaners that are especially made for cleaning stainless steel. Always be sure to rinse the cleaners from the surface as bluish stains may occur during heating that cannot be removed.
<ul style="list-style-type: none">● Porcelain enamel broiler pan and insert (available by mail order)● Door liner & body parts	Gentle scouring with a soapy scouring pad will remove most spots. Rinse with a 1:1 solution of clear water and ammonia. If necessary, cover difficult spots with an ammonia-soaked paper towel for 30 to 40 minutes. Rinse with clean water and a damp cloth, and then scrub with a soap-filled scouring pad. Rinse and wipe dry with a clean cloth. Remove all cleaners or the porcelain may become damaged during future heating. DO NOT use spray oven cleaners on the cooktop.
<ul style="list-style-type: none">● Oven racks	Oven racks must be removed from oven cavity. Clean by using a mild, abrasive cleaner following manufacturer's instructions. Rinse with clean water and dry.
<ul style="list-style-type: none">● Oven door	Use soap & water to thoroughly clean the top, sides and front of the oven door. Rinse well. You may use a glass cleaner on the outside glass of the door. Do not immerse the door in water. Do not spray or allow water or the glass cleaner to enter the door vents. Do not use oven cleaners, cleaning powders or any harsh abrasive cleaning materials on the outside of the oven door. Do not clean the oven door gasket. On self-clean models, the oven door gasket is made of a woven material which is essential for a good seal. Care should be taken not to rub, damage or remove this gasket.

Care and cleaning of stainless steel

Some models are equipped with stainless steel exterior parts. Special care and cleaning are **required** for maintaining the appearance of stainless parts. Refer to the **General Care & Cleaning** table for detailed cleaning instructions.

Removing and replacing the lift-off oven door

CAUTION

The door is heavy. For safe, temporary storage, lay the door flat with the inside of the door facing down.

To Remove Oven Door:

1. Open oven door completely (horizontal with floor - See Figure 1).
2. Pull the door hinge locks on both left and right door hinges down from the oven frame completely towards the oven door (See Figure 2). A tool such as a small flat-blade screwdriver may be required.
3. Firmly grasp both sides of oven door along the door sides (Do not use the oven door handle - See Figure 3).
4. Close the door to the broil stop position (the oven door will stop into this position just before fully closing).
5. With the oven door in the broil stop position, lift the oven door hinge arms over the roller pins located on each side of the oven frame (See Figure 4).

To Replace Oven Door:

1. Firmly grasp both sides of oven door along the door sides (Do not use the oven door handle - See Figure 3).
2. Holding the oven door at the same angle as the removal position, seat the hook of the hinge arm over the roller pins located on each side of the oven door frame (See Figure 4). The hook of the hinge arms must be fully seated onto the roller pins.
3. Fully open the oven door (horizontal with floor - See Figure 1).
4. Push the door hinge locks up towards and into the oven frame on both left and right oven door hinges (See Figure 2) to the locked position.
5. Close the oven door.



Door Hinge locations
with oven door fully open
Figure 1

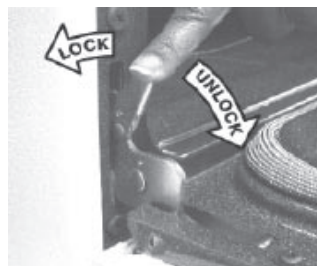

Figure 2

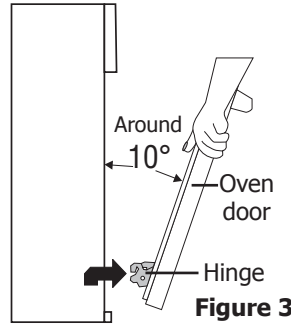

Figure 3

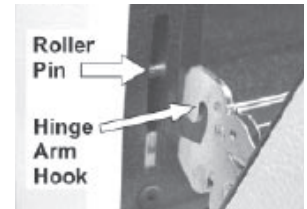

Figure 4

Special door care instructions - Most oven doors contain glass that can break.

Read the following recommendations:

1. Do not close the oven door until all the oven racks are fully in place.
2. Do not hit the glass with pots, pans, or any other object.
3. Scratching, hitting, jarring or stressing the glass may weaken its structure causing an increased risk of breakage at a later time.

Changing oven light

CAUTION

Be sure the oven is unplugged and all parts are **COOL** before replacing the oven light bulb. Do not turn the oven light on during a self-cleaning cycle. High temperature will reduce lamp life.

On some models an interior oven light will turn on automatically when the oven is opened. The oven light may be turned on when the door is closed by using the oven light switch located on the Electronic Oven control. The oven light bulb is covered with a glass shield held in place by a wire holder. **THIS GLASS SHIELD MUST ALWAYS BE IN PLACE WHEN THE OVEN IS IN USE.**

CAUTION

BE SURE OVEN IS COOL

To Replace the Light Bulb:

1. Turn the power off at the main source.
2. Wear a leather-faced glove for protection against possible broken glass.
3. Replace bulb with a 40 Watt appliance bulb only.
4. For self-cleaning oven, press wire holder to one side to release glass shield, change bulb and be sure to replace glass shield.







BEFORE YOU CALL

Oven Baking

For best cooking results, heat the oven before baking cookies, breads, cakes, pies or pastries, etc. There is no need to preheat the oven for roasting meat or baking casseroles.

The cooking times and temperatures needed to bake a product may vary slightly from your previously owned appliance.

Baking Problems and Solutions Chart

BAKING PROBLEMS	CAUSES	CORRECTIONS
<p>Cookies and biscuits burn on the bottom.</p> 	<ul style="list-style-type: none"> • Cookies and biscuits put into the oven before the preheating time is completed. • Oven rack overcrowded. • Dark pan absorbs heat too fast. 	<ul style="list-style-type: none"> • Allow oven to preheat to the selected temperature before placing food in oven. • Choose pan sizes that will permit 5.1cm to 10.2cm (2" to 4") of air space on all sides when placed in the oven. • Use a medium-weight aluminum baking sheet.
<p>Cakes too dark on top or bottom.</p> 	<ul style="list-style-type: none"> • Cakes put into the oven before preheating time is completed. • Rack position too high or low. • Oven too hot. 	<ul style="list-style-type: none"> • Allow oven to preheat to the selected temperature before placing food in the oven. • Use proper rack position for baking needs. • Set oven temperature 25°F/12°C lower than recommended.
<p>Cakes not done in the center.</p> 	<ul style="list-style-type: none"> • Oven too hot. • Incorrect pan size. • Pan not centered in oven. 	<ul style="list-style-type: none"> • Set oven temperature 25°F/12°C lower than recommended. • Use pan size suggested in recipe. • Use proper rack position and place pan so there is 5.1cm to 10.2cm (2" to 4") of space on all sides of pan.
<p>Cakes not level.</p> 	<ul style="list-style-type: none"> • Range not level. • Pan too close to oven wall or rack overcrowded. • Pan warped. 	<ul style="list-style-type: none"> • Place a marked glass measuring cup filled with water on the center of the oven rack. If the water level is uneven, refer to the installation instructions for leveling the range. • Be sure to allow 5.1cm to 10.2cm (2" to 4") of clearance on all sides of each pan in the oven. • Do not use pans that are dented or warped.
<p>Foods not done when cooking time is up.</p> 	<ul style="list-style-type: none"> • Oven too cool. • Oven overcrowded. • Oven door opened too frequently. 	<ul style="list-style-type: none"> • Set oven temperature 25°F/12°C higher than suggested and bake for the recommended time. • Be sure to remove all pans from the oven except the ones to be used for baking. • Open oven door only after shortest recommended baking time.

BEFORE YOU CALL - Solutions to Common Problems

IMPORTANT

Before you call for service, review this list. It may save you time and expense. The list includes common occurrences that are not the result of defective workmanship or materials in this appliance.

OCCURRENCE	POSSIBLE CAUSE/SOLUTION
Oven Control Beeps and Displays an "F" Error Code	Electronic control has detected a fault condition. Push CLEAR pad to clear the display and stop the display from beeping. Reprogram the oven. If a fault reoccurs, record the fault number, push the CLEAR pad and contact an authorized servicer.
Faulty Installation	Place oven rack in center of oven. Place a level on the oven rack. Contact installing agent if rack and cabinet cutout flooring are not level. Kitchen cabinet misalignment may make oven appear to be not level. Be sure cabinets are square and level. Contact cabinet maker to correct problem.
Entire Oven Does Not Operate	When the oven is first plugged in, or when the power supply to the oven has been interrupted, the display will flash. The oven cannot be programmed until the clock is set. Be sure electrical cord is securely connected into the electrical junction box. Cord/plug is not installed and/or connected. Cord is not supplied with oven. Contact your dealer, installing agent or authorized servicer. Service wiring not complete. Contact your dealer, installing agent or authorized servicer. Power outage. Check house lights to be sure. Call your local electric company. Short in cord/plug. Replace cord/plug. Controls are not set properly. See instructions to set the controls. House fuse has blown or circuit breaker has tripped immediately following installation. House fuse may not be fully engaged. Check fuse and screw or engage circuit breaker securely.
Oven Light Does Not Work	Burned-out or loose bulb. Follow the instructions under Oven Light to replace or tighten the bulb.
Self-Cleaning Cycle Does Not Work	Make sure the oven door is closed. Controls not set properly. Follow instructions under "Using the Self-Clean Feature".
Oven Smokes Excessively During Broiling	Meat too close to the broiler element. Reposition the rack to provide more clearance between the meat and the broiler. Preheat broil element for quick searing operation. Meat not properly prepared. Remove excess fat from meat. Cut remaining fatty edges to prevent curling, but do not cut into the lean. Grid on broiler pan wrong side-up. Grease does not drain into broiler pan. Always place the grid on the broiler pan with the ribs up and the slots down to allow grease to drip into the pan. Broiler pan used without grid or grid cover with aluminum foil. DO NOT use the broiler pan without the grid or cover the grid with aluminum foil. Oven needs to be cleaned. Grease has built up on oven surfaces. Regular cleaning is necessary when broiling frequently. Grease or food spatters cause excessive smoking.
Soil Not Completely Removed After Self-Cleaning Cycle is Completed	Failure to clean bottom, from top of oven, frame of oven or door area outside oven seal. These areas are not in the self-cleaning area, but get hot enough to burn on residue. Clean these areas before the self-cleaning cycle is started. Burned on residue can be cleaned with a stiff nylon brush and water or a nylon scrubber. Be careful not to damage the oven gasket. Excessive spillovers in oven. Set the self-clean cycle for longer cleaning time.
Poor Baking Results	Many factors affect baking results. See Baking for hints, causes and corrections. See Adjusting Oven Temperature.
Flames Inside Oven or Smoke from Vent	Excessive spillovers in oven. This is normal, especially for high oven temperatures, pie spillovers or for large amounts of grease on bottom of oven. Wipe up excessive spillovers.

MAJOR APPLIANCE WARRANTY

Your appliance is covered by a one year limited warranty. For one year from your original date of purchase, Electrolux will pay all costs for repairing or replacing any parts of this appliance that prove to be defective in materials or workmanship when such appliance is installed, used and maintained in accordance with the provided instructions.

Exclusions This warranty does not cover the following:

- 1 Products with original serial numbers that have been removed, altered or cannot be readily determined.
- 2 Product that has been transferred from its original owner to another party or removed outside the USA or Canada.
- 3 Rust on the interior or exterior of the unit.
- 4 Products purchased "as-is" are not covered by this warranty.
- 5 Food loss due to any refrigerator or freezer failures.
- 6 Products used in a commercial setting.
- 7 Service calls which do not involve malfunction or defects in materials or workmanship, or for appliances not in ordinary household use or used other than in accordance with the provided instructions.
- 8 Service calls to correct the installation of your appliance or to instruct you how to use your appliance.
- 9 Expenses for making the appliance accessible for servicing, such as removal of trim, cupboards, shelves, etc., which are not a part of the appliance when it is shipped from the factory.
- 10 Service calls to repair or replace appliance light bulbs, air filters, water filters, other consumable, or knobs, handles, or other cosmetic parts.
- 11 Surcharges including, but not limited to, any after hour, weekend, or holiday service calls, tolls, ferry trip charges, or mileage expense for service calls to remote areas, including the state of Alaska.
- 12 Damages to the finish of appliance or home incurred during installation, including but not limited to floors, cabinets, walls, etc.
- 13 Damages caused by: services performed by unauthorized service companies; use of parts other than genuine Electrolux parts or parts obtained from persons other than authorized service companies; or external causes such as abuse, misuse, inadequate power supply, accidents, fires, or acts of God.

DISCLAIMER OF IMPLIED WARRANTIES; LIMITATION OF REMEDIES

Customer's sole and exclusive remedy under this limited warranty shall be product repair or replacement as provided herein. Claims based on implied warranties, including warranties of merchantability or fitness for particular purpose, are limited to one year or the shortest period allowed by law, but not less than one year. Electrolux shall not be liable for consequential or incidental damages such as property damage and incidental expenses resulting from any breach of this written limited warranty or any implied warranty. Some states and provinces do not allow the exclusion or limitation of incidental or consequential damages, or limitations on the duration of implied warranties, so these limitations or exclusions may not apply to you. This written warranty gives you specific legal rights. You may also have other rights that vary from state to state.

If You Need Service

Keep your receipt, delivery slip, or some other appropriate payment record to establish the warranty period should service be required. If service is performed, it is in your best interest to obtain and keep all receipts. Service under this warranty must be obtained contacting Electrolux at the addresses or phone numbers below.

This warranty only applies in the USA and Canada. In the USA, your appliance is warranted by Electrolux Major Appliances North America, a division of Electrolux Home Products, Inc. In Canada, your appliance is warranted by Electrolux Canada Corp. Electrolux authorizes no person to change or add to any obligations under this warranty. Obligations for service and parts under this warranty must be performed by Electrolux or an authorized service company. Product features or specifications as described or illustrated are subject to change without notice.

USA
1.800.944.9044
Electrolux Major Appliances
North America
P.O. Box 212378
Augusta, GA 30907



Canada
1.800.265.8352
Electrolux Canada Corp.
5855 Terry Fox Way
Mississauga, Ontario, Canada
L5V 3E4