

FRIGIDAIRE

All about the

Use & Care

of your Wall Oven

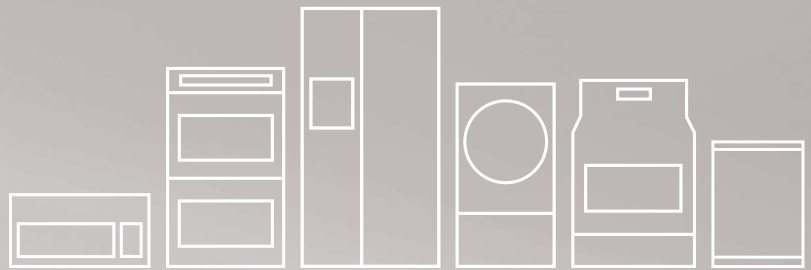

TABLE OF CONTENTS

Product Record and Registration	2	Setting Oven Controls	12
Important Safety Instructions	3	Care and Cleaning	23
Cooking Recommendations	8	Before You Call	28
Before Setting Oven Controls	11	Warranty	31

PRODUCT RECORD AND REGISTRATION

Need Help?	2
Product Registration	2
Product Record and Registration	2
Important Safety Instructions	3
Cooking Recommendations	8
Before Setting Oven Controls	11
Setting Oven Controls	12
Care and Cleaning	23
Before You Call	28
Warranty	31

Need Help?

Visit the Frigidaire web site at www.frigidaire.com

Before you call for service, there are a few things you can do to help us serve you better.

Read this Use & Care Manual

This manual contains instructions to help you use and maintain your oven properly.

If You Received a Damaged Oven...

Immediately contact the dealer (or builder) that sold you the oven.

Save Time and Money

Check "[Solutions to Common Problems](#)" on page 29. This section helps step you through some common problems that might occur.

If you do need service, help is only a phone call away. Call Frigidaire customer services at **1-800-944-9044**.

Product Registration

Registering your product with Frigidaire enhances our ability to serve you. You can register online at <http://www.frigidaire.com> or by dropping your product registration card in the mail.

Record model and serial numbers here

Purchase Date: _____

Frigidaire model number: _____

Frigidaire serial number: _____

Serial Plate Location

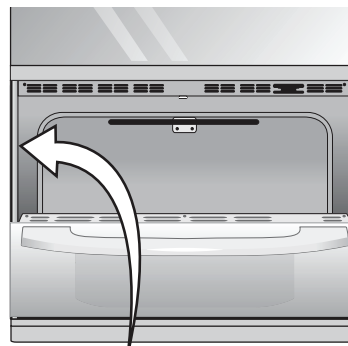

Questions?

For toll-free telephone support in the U.S. and Canada call **1-800-944-9044**

For online support and product information visit <http://www.frigidaire.com>.

Thank you for choosing Frigidaire.

This Use & Care manual is part of our commitment to customer satisfaction and product quality throughout the service life of your new appliance. We view your purchase as the beginning of a relationship. To ensure our ability to continue serving you, please use this page to record important product information.

IMPORTANT SAFETY INSTRUCTIONS

Read all instructions before using this appliance.

This manual contains important safety symbols and instructions. Please pay attention to these symbols and follow all instructions given.

Do not attempt to install or operate your appliance until you have read the safety precautions in this manual. Safety items throughout this manual are labeled with a **WARNING** or **CAUTION** statement based on the risk type.

Warnings and important instructions appearing in this guide are not meant to cover all possible conditions and situations that may occur. Common sense, caution, and care must be exercised with installing, maintaining, or operating your appliance.

DEFINITIONS

 This is the safety alert symbol. It is used to alert you to potential personal injury hazards. Obey all safety messages that follow this symbol to avoid possible injury or death.

WARNING

Indicates a potentially hazardous situation which, if not avoided, may result in death or serious injury.

CAUTION

Indicates a potentially hazardous situation which, if not avoided, may result in minor or moderate injury.

IMPORTANT

Indicates installation, operation, maintenance, or valuable information that is not hazard related.

NOTE

Indicates a short, informal reference-something written down to assist the memory or for future reference.

WARNING

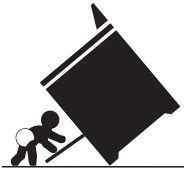

Tip Over Hazard

- A child or adult can tip the oven and be killed.
- Install the anti-tip device to oven and/or structure per installation instructions.
- Ensure the anti-tip device is re-engaged when the oven is moved.
- Do not operate the oven without the anti-tip device in place and engaged.
- Failure to follow these instructions can result in death or serious burns to children and adults.

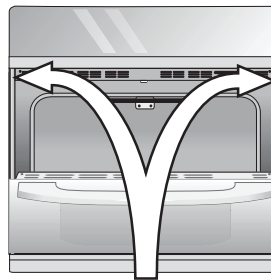

Anti-tip mounting holes

Refer to the installation instructions supplied with your appliance for proper installation.

Check for proper installation with a visual check that the anti-tip screws are present. Test the installation with light downward pressure on the open oven door. The oven should not tip forward.

IMPORTANT SAFETY INSTRUCTIONS

IMPORTANT INSTRUCTIONS FOR UNPACKING AND INSTALLATION

IMPORTANT

Read and follow the below instructions and precautions for unpacking, installing, and servicing your appliance:

Remove all tape and packaging before using the appliance. Destroy the carton and plastic bags after unpacking the appliance. Never allow children to play with packaging material. Do not remove the wiring label and other literature attached to the range. Do not remove model/serial number plate.

Cold temperatures can damage the electronic control. When using this appliance for the first time, or when the appliance has not been used for an extended period of time, be sure the appliance has been in temperatures above 32°F (0°C) for at least 3 hours before turning on the power to the appliance.

Never modify or alter the construction of the appliance by removing the leveling legs, panels, wire covers, anti-tip brackets/screws, or any other part of the appliance.

Be sure to have an appropriate foam-type fire extinguisher available, visible, and easily accessible located near the appliance.

GROUNDING INSTRUCTIONS

WARNING

Avoid fire hazard or electrical shock. Failure to follow this warning may cause serious injury, fire, or death.

Avoid fire hazard or electrical shock. Do not use an adapter plug, use an extension cord, or remove grounding prong from the power cord. Failure to follow this warning may cause serious injury, fire, or death.

Proper Installation—Be sure your appliance is properly installed and grounded by a qualified technician. In the United States, install in accordance with the National Fuel Gas Code ANSI Z223.1/NPFA No. 54, latest edition and National Electrical Code NFPA No. 70 latest edition, and local electrical code requirements. In Canada, install in accordance with CAN/CGA B149.1 and CAN/CGA B149.2 and CSA Standard C22.1, Canadian Electrical code, Part 1-latest editions and local electrical code requirements. Install only per installation instructions provided in the literature package for this appliance.

For personal safety, this appliance must be properly grounded. For maximum safety, the power cord must be securely connected to an electrical outlet or junction box that is the correct voltage, is correctly polarized and properly grounded, and protected by a circuit breaker in accordance with local codes.

It is the personal responsibility of the consumer to have the appropriate outlet or junction box with the correct, properly grounded wall receptacle installed by a qualified electrician. It is the responsibility and obligation of the consumer to contact a qualified installer to assure that the electrical installation is adequate and is in conformance with all local codes and ordinances.

See the installation instructions packaged with this appliance for complete installation and grounding instructions.

IMPORTANT SAFETY INSTRUCTIONS

IMPORTANT INSTRUCTIONS FOR USING THE APPLIANCE

WARNING

Storage In or On Appliance—Flammable materials should not be stored in an oven, near surface burners, or in the warmer drawer (if equipped). This includes paper, plastic, and cloth items, such as cookbooks, plastic ware, and towels, as well as flammable liquids. Do not store explosives, such as aerosol cans, on or near the range.

Do not leave children alone - Children should not be left alone or unattended in the area where the appliance is in use. They should never be allowed to sit or stand on any part of the appliance, including the storage drawer, lower broiler drawer, or lower double oven.

Do not store items of interest to children in the cabinets above the appliance or on the back-guards of ranges. Children climbing on or near the appliance to reach items could be seriously injured.

Do not allow children to climb or play around the appliance. The weight of a child on an open oven door may cause the appliance to tip, resulting in serious burns or other injury. An open drawer when hot may cause burns.

Stepping, leaning, or sitting on the door or drawers of this appliance can result in serious injuries and also cause damage to the appliance.

WARNING

Never cover any slots, holes, or passages in the oven bottom or cover an entire oven rack with materials such as aluminum foil or aftermarket oven liners. Aluminum foil linings may trap heat, causing a fire hazard.

Do not use oven or warmer drawer (if equipped) for storage.

Never use your appliance as a space heater to heat or warm the room. Doing so may result in carbon monoxide poisoning and overheating of the appliance.

CAUTION

When heating fat or grease, watch it closely. Grease may catch fire if it becomes too hot.

Do not use water or flour on grease fires. Smother fire or flame or use dry chemical or foam-type extinguisher. Cover the fire with a pan lid or use baking soda.

Use dry potholders. Moist or damp potholders on hot surfaces may result in burns from steam. Do not let potholders touch hot cooking areas. Do not use towels or other bulky cloths.

Do not heat unopened food containers - Build-up of pressure may cause container to burst and result in injury.

Wear proper apparel - Loose-fitting or hanging garments should never be worn while using the appliance. Do not let clothing or other flammable materials contact hot surfaces.

IMPORTANT SAFETY INSTRUCTIONS

CAUTION

Do not touch surface burners or elements, areas near these burners or elements, interior surfaces of the oven, or the warmer drawer (if equipped). Surface burners and elements may be hot even though they appear cool. Areas near surface burners and elements may become hot enough to cause burns. During and after use, do not touch, or let clothing or other flammable materials touch these areas until they are cool. These areas may include the cooktop, surfaces facing the cooktop, oven vent areas, oven door, and oven window.

Do not attempt to operate the appliance during a power failure. If the power fails, always turn off the appliance. If the appliance is not turned off and the power resumes, electric surface elements may resume operation when power is restored. Once the power resumes, reset the clock and the oven function.

Keep oven vent ducts unobstructed. Touching surfaces in this area when the oven is on may cause severe burns. Do not place plastic or heat-sensitive items on or near the oven vent. These items can melt or ignite.

Placement of oven racks - Always place oven racks in desired location while oven is cool. If rack must be moved while oven is hot, do not let potholder contact hot burner or element in oven. Use potholders and grasp the rack with both hands to reposition. Remove all cookware and utensils before moving the rack.

Do not use a broiler pan without its insert. Broiler pans and inserts allow dripping fat to drain away from the high heat of the broiler. Do not cover the broiler insert with aluminum foil; exposed fat and grease could ignite.

Do not cook food on the oven bottom. Always cook in proper cookware and always use the oven racks.

IMPORTANT INSTRUCTIONS FOR USING YOUR OVEN

Protective liners—Do not use aluminum foil, after-market oven liners, or any other materials or devices to line oven bottom, oven racks, or any other part of the appliance. Only use aluminum as recommended for baking, such as lining cookware or as a cover placed on food. Any other use of protective liners or aluminum foil may result in a risk of electric shock or fire or a short circuit.

Use care when opening oven door, lower oven door, or warmer drawer (some models). Stand to the side of the appliance when opening the door of a hot oven. Let hot air or steam escape before you remove or replace food in the oven.

IMPORTANT INSTRUCTIONS FOR CLEANING YOUR APPLIANCE

CAUTION

Before manually cleaning any part of the appliance, be sure all controls are turned off and the range is cool. Cleaning a hot oven can cause burns.

Clean the appliance regularly to keep all parts free of grease that could catch fire. Do not allow grease to accumulate. Greasy deposits in the fan could catch fire.

Always follow the manufacturer's recommended directions for use of kitchen cleaners and aerosols. Be aware that excess residue from cleaners and aerosols may ignite causing damage and injury.

IMPORTANT SAFETY INSTRUCTIONS

Clean ventilating hoods frequently - Grease should not be allowed to accumulate on hood or filter. Follow the manufacturer's instructions for cleaning vent hoods.

IMPORTANT INSTRUCTIONS FOR SELF CLEANING OVENS

Do not clean the oven door gasket. The door gasket is essential for a good seal. Care should be taken not to rub, damage, or move the gasket.

Do not use oven cleaners. No commercial oven cleaner or oven liner protective coating of any kind should be used in or around any part of the appliance.

Use the Self Clean cycle to clean only the parts listed in this manual.

Before using Self Clean, remove the broiler pan, any food, utensils, and cookware from the oven, storage drawer or warming drawer (if equipped). Remove oven racks unless otherwise instructed.

Some birds are extremely sensitive to the fumes given off during the Self Clean cycle of any oven. Move birds to another well-ventilated room.

IMPORTANT INSTRUCTIONS FOR SERVICE AND MAINTENANCE

Do not repair or replace any part of the appliance unless specifically recommended in the manuals. All other servicing should be done only by a qualified technician. This reduces the risk of personal injury and damage to the appliance.

Always contact your dealer, distributor, service agent, or manufacturer about problems or conditions you do not understand.

Ask your dealer to recommend a qualified technician and an authorized repair service. Know how to disconnect the power to the appliance at the circuit breaker or fuse box in case of an emergency.

Remove the oven door from any unused oven if it is to be stored or discarded.

Do not touch a hot oven light bulb with a damp cloth. Doing so could cause the bulb to break. Handle halogen lights (if equipped) with paper towels or soft gloves. Disconnect the appliance or shut off the power to the appliance before removing and replacing the bulb.

Important Safety Notice - The California Safe Drinking Water and Toxic Enforcement Act requires the governor of California to publish a list of substances known to cause cancer, birth defects, or other reproductive harms, and requires businesses to warn customers of potential exposures to such substances.

COOKING RECOMMENDATIONS

Bakeware

The material of bakeware affects how evenly and quickly it transfers heat from the pan to the food.

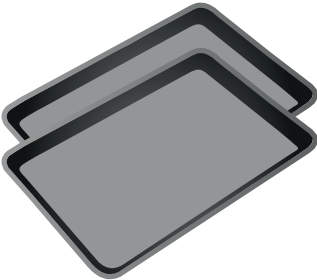
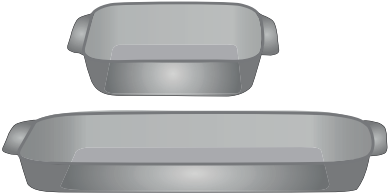
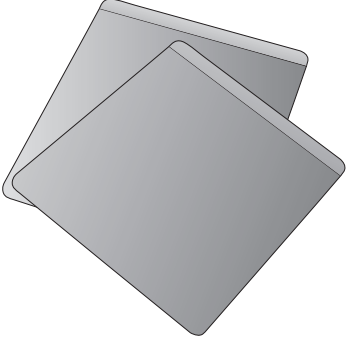
Material	Attributes	Recommendation
<p>Shiny metal bakeware</p> 	<p>Shiny, aluminum, and non-coated bakeware is the best for even heating. It is suitable for all baked goods.</p>	<p>Recommended cooking temperatures and times are based on shiny metal bakeware.</p>
<p>Dark metal bakeware</p> 	<p>Dark bakeware cooks hotter than shiny bakeware.</p>	<p>Reduce the cooking temperature by 25° F (13-14° C) when using dark bakeware.</p>
<p>Glass bakeware</p> 	<p>Glass bakeware cooks hotter than shiny bakeware.</p> <p>Glass is convenient, as the same piece of bakeware can be used for cooking, serving, and storing food.</p>	<p>Reduce the cooking temperature by 25° F (13-14° C) when using glass bakeware.</p>
<p>Insulated bakeware</p> 	<p>Insulated bakeware cooks cooler than shiny bakeware.</p> <p>Insulated bakeware is designed for baking in gas ovens.</p>	<p>Increase the cooking temperature by 25° F (13-14° C) when using insulated bakeware.</p>

COOKING RECOMMENDATIONS

Cooking Conditions

Conditions in your kitchen can affect the performance of your appliance when cooking food.

Condition	Attributes	Recommendation
Aging cookware	As pans age and become discolored, cooking times may need to be reduced slightly.	If food is too dark or overcooked, use the minimum cook time in the recipe or packaging. If food is too light or undercooked, use the middle to maximum cook time in the recipe or packaging.
High altitude	Air is drier and air pressure is lower. Water boils at a lower temperature, and liquids evaporate faster. Foods may take longer to bake. Doughs may rise faster.	Adjust cooking temperature, cooking time, or recipes as needed. Increase amount of liquid in baking recipes. Increase cook time on cooktop. Cover dishes to reduce evaporation. Increase bake time or oven temperature. Reduce amount of baking soda or baking powder in recipe. Reduce rising time or punch down dough and allow it to rise twice.

Cooking Results

Small adjustments may fix a problem with food not being as done as you like or more done than you like.

Result	Recommendation
Food too light	Use the middle to maximum cook time recommended on packaging or recipe.
Food too dark	Use the minimum cook time recommended on packaging or recipe.

Cooking Tips

Use these additional tips to get the best results from your appliance.

Cooking	Tips
Baking	
Rack placement	Follow the instructions in “Oven Control Features” on starting on page 12 . When using only one rack, place the rack so the food is in the center of the oven.
Preheat	Fully preheat the oven before baking items like cookies, cakes, biscuits and breads. Insert food immediately after the beep.
Checking food	Use the window and oven light when checking food. Opening the door may reduce baking performance.
Food placement	Allow at least 2 inches (5 cm) of space between bakeware for proper air circulation.

COOKING RECOMMENDATIONS

Cooking	Tips
Broiling / Roasting	
Broiling pan	<p>For best results when broiling, use a broil pan with a broil pan insert designed to drain the fat from the food, help avoid spatter, and reduce smoking. The broiler pan will catch grease spills, and the insert helps prevent grease splatters.</p> <p>If a broiler pan and insert are not supplied with this appliance, they may be purchased from Frigidaire.com.</p>

BEFORE SETTING OVEN CONTROLS

Oven Vent Location

The oven is vented as shown below. When the oven is on, warm air is released through the vent. This venting is necessary for proper air circulation in the oven and good baking results. Do not block oven vent. Never close off the openings with aluminium foil or any other material. Steam or moisture may appear near the oven vent; this is normal.

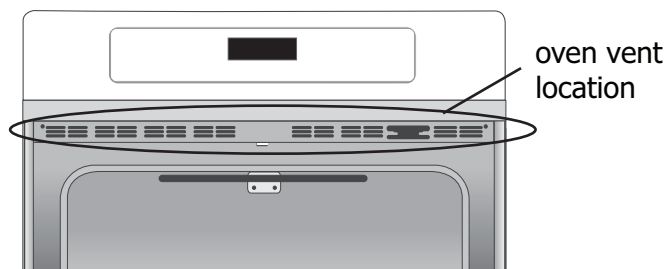

Figure 1: Do not block oven vent location

Note: Some models are equipped with a cooling fan that runs during the cooking process to cool internal electronic components. It is normal for this fan to continue to run for an extended period of time, even when the oven is off.

CAUTION

Always use pot holders or oven mitts when using the oven. When cooking, the oven interior and exterior, oven racks, and cooktop will become very hot which can cause burns.

WARNING

Protective Liners — Do not use aluminum foil or any other materials to line the oven bottom, walls, racks or any part of the oven. Only use aluminum foil as recommended in this manual. Improper installation of these liners may result in risk of electric shock or fire.

IMPORTANT

All oven racks should be removed before a Self Clean operation. Racks left in the oven during the high heat of the Self Clean function can easily discolor. The ability of the racks to easily slide in and out along the rack positions may also be affected.

Type of oven racks

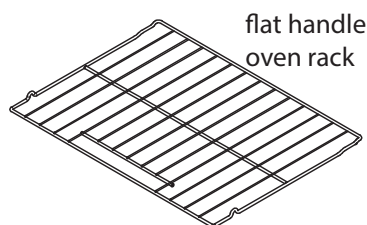

flat handle
oven rack

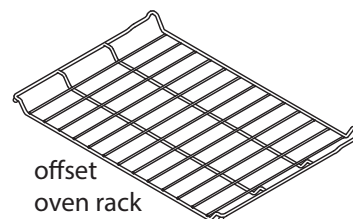

offset
oven rack

Oven Rack Descriptions

- **Flat oven racks** (or the **flat handle** oven rack) may be used for most cooking needs and may be placed in most oven rack positions.
- The **offset oven rack** (some models) provides additional step down positions from the standard flat rack design. The offset design positions the base of the rack about $\frac{1}{2}$ of a rack position lower than the flat rack and may be used in most oven rack positions.

Removing, replacing, and arranging flat or offset oven racks

To arrange - Always arrange the oven racks when the oven is cool (prior to operating the oven).

To remove - Pull the oven rack straight forward until it reaches the stop position. Lift up front of oven rack slightly and slide out.

To replace - Place the oven rack on the rack guides on both sides of oven walls. Tilt the front of oven rack upward slightly and slide the oven rack back into place. Be sure oven racks are level before using.

SETTING OVEN CONTROLS

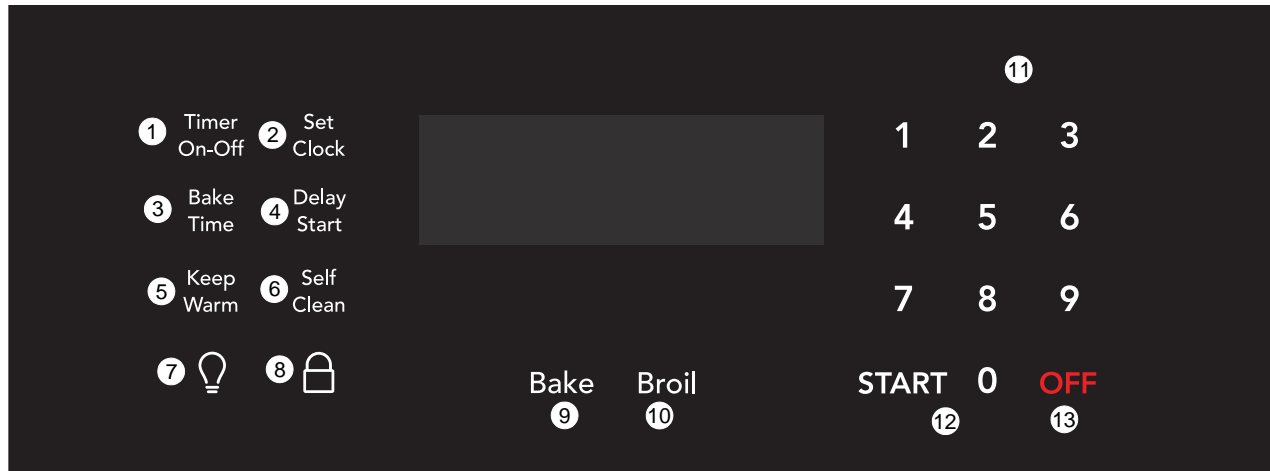

Oven Control Features

1. **Timer on-off** - Use to set or cancel the minute timer. The minute timer does not start or stop any cooking function.
2. **Set Clock** - Use to set clock. Clock must be set before oven controls are operational..
3. **Bake Time** - Use to set length of baking time desired and for cooking to end automatically.
4. **Delay Start** - Add to Bake and Self Clean to program a Delay Start.
5. **Keep Warm** - Use to keep cooked foods at serving temperature of 170°F (77°C) for up to three hours.
6. **Self Clean** - Use to set self-clean cycle of 2, 3, or 4hrs.
7. **Oven Light** - Use to turn on internal light. Will turn on when the oven door is open.
8. **Oven Lock** - Use to lock oven door and oven controls.
9. **Bake** - Use to select Bake feature.
10. **Broil** - Use to set Broil feature for temperatures between 400°F(205°C) and 550°F(288°C).
11. **0 through 9 keys** - Use to set temperature and time.
12. **START** - Use to start most oven features and to set clock.
13. **OFF** - Use to clear any feature except the time of day and minute timer.

Time and Temperature Settings

All of the features listed below may be entered into the control. An entry acceptance beep will sound each time a control key is touched (the acceptance beep on the oven lockout key is delayed 3 seconds). An entry **error tone** (3 short beeps) will sound if the entry of the temperature or time is below the minimum or above the maximum settings for the feature.

Feature	Mode	Min.Temp. / Time	Max Temp. /Time
Bake		170°F (77°C)	550°F (288°C)
Broil		400°F (205°C)	550°F (288°C)
Keep Warm		170°F (77°C)	3 hours
Timer		0:01 Min. 0:01 Min	11:59 Hr./Min. 11:59 Hr./Min.
Clock Time	12 Hr. 24 Hr.	1:00 Hr./Min. 0:00 Min	12:59 Hr./Min. 23:59 Hr./Min.
Delay Start	12 Hr. 24 Hr.	1:00 Hr./Min. 0:00 Min	12:59 Hr./Min. 23:59 Hr./Min
Bake Time	12 Hr. 24 Hr.	0:01 Min 0:01 Min	11:59 Hr./Min. 23:59 Hr./Min.
Self Clean		2 hours	4 hours

Note: An entry acceptance tone (1beep) will sound each time a key is touched (the oven lock key is delayed 3 seconds). An entry error tone (3 short beeps) will sound if the entry of the temperature or time is below the minimum or above the maximum settings for the feature.

SETTING OVEN CONTROLS

Setting the Clock

The set clock control is used to set the clock. The clock may be set for 12 or 24 hours display operation. The clock is preset at the factory for 12 hour display. When the oven is first plugged in, or when the power supply to the oven has been interrupted, the timer in the display will flash.

To set the clock (example below for 1:30):

1. Press **Set Clock**. **CLO** will appear in the display.
2. Press **1 3 0** on the keypad to set the time of day to 1:30. **CLO** will stay in the display.
3. Press **START**. **CLO** will disappear and the clock will start.

Setting Control for Silent Operation

Delay Start and **Self Clean** keys control the silent control operation feature. The silent control operation feature allows the oven control to be operated without sounds or beeps whenever necessary. If desired the control can be programmed for silent operation and later returned to operating with all the normal sounds and beeps.

To change control from normal sound operation to silent control operation:

1. To set oven for normal or silent operation, press and hold **Delay Start**. -- -- will appear and **DELAY** will flash in the display. After 6 seconds **bEEP On** or **bEEP OFF** will appear in the display.
2. Press **Self Clean** to switch between normal sound operation and silent operation mode. The display will show either **bEEP On** or **bEEP OFF**. If **bEEP On** appears, the control will operate with normal sounds and beeps. If **bEEP OFF** appears, the control is in the silent operation mode.
3. Press **START** to accept the change or press **OFF** to reject the change.

Setting 12 or 24 Hour Time of Day Display

1. Press and hold **set clock** for 6 seconds. **CLO** will appear in the display.
2. Continue holding the key until **12Hr dAY** or **24Hr dAY** appears in the display and the control beeps once.
3. Press **Self Clean** to switch between the 12 and 24 hour time of day display. The display will show either **12Hr dAY** or **24Hr dAY**.
4. Press **START** to accept the change or press **OFF** to reject the change.
5. Reset the correct time as described in this section. If the 24 hour time of day mode was chosen, the clock will display time from 0:00 through 23:59 hours.

Setting Continuous Bake or 12 Hour Energy Saving

The **Timer On-Off** and **Self Clean** keys control the continuous bake or 12 hour energy saving features. The oven control has a factory preset 12 Hour Energy Saving feature that shuts off the oven if the oven control is left on for more than 12 hours. The oven can be programmed to override this feature for Continuous Baking.

To set the control for continuous bake or 12 hour energy saving:

1. Press and hold **Timer On-Off** for 5 seconds. **12Hr OFF** or **StAY On** will appear in the display and the control will beep once.
2. Press **Self Clean** to switch between the 12 hour energy saving and continuous bake features.
3. Press **START** to accept the change (display will return to time of day) or press **OFF** to reject the change.

12Hr OFF indicates the control is set for the 12 hour energy saving mode. **StAY On** indicates the control is set for the continuous bake feature.

SETTING OVEN CONTROLS

Temperature Display (Fahrenheit/Celsius)

The **Broil** and **Self Clean** keys control the Fahrenheit (°F) or Celsius (°C) temperature display modes. The oven control can be programmed to display temperatures in °F or °C. The oven is preset at the factory to display in °F.

To change display from °F to °C or °C to °F

1. To tell if the display is set for °F or °C, press **Broil** and hold for 6 seconds. **550°** will appear, **Broil** will flash in the display, and a beep will sound. If **F** appears, the display is set to show temperatures in °F. If **C** appears, the display is set to show temperatures in °C.
2. Press **Self Clean** to switch between °F or °C display modes. The display will show either **F** or **C**.
3. Press **START** to accept the change or press **OFF** to reject the change.

NOTE

The control will always beep at the end of a minute timer and will beep when a set temperature has been reached, even if the control is set to silent operation.

Setting the Timer

The **Timer On-Off** key controls the minute timer and serves as an extra timer and can be used during any of the other oven control functions.

To set the minute timer:

1. Press **Timer On-Off**. -- -- will appear and **timer** will flash in the display. Press the number keys to set the desired time.
2. Press **START**. The time will begin to count down and **Timer** will stay in the display. When the time expires, **End** and **Timer** will show in the display. The clock will beep three times every 30 seconds until **Timer On-Off** is pressed.
3. To cancel the minute timer before the set time expires, press **Timer On-Off**.

NOTE

If **START** is not pressed, the timer will return to the time of day after 25 seconds. The timer does not start or stop the cooking process.

Setting Oven Lockout Feature

The **lock icon** controls the oven lockout. When active, this feature automatically locks the oven door, preventing the oven from being turned on. It does not affect the clock, timer, or the interior oven lights.

To activate the oven lockout feature:

1. Press and hold the **lock icon** for 3 seconds.
2. After 3 seconds, **door Loc** will appear, a tone will sound, and the word **DOOR** and the lock icon will flash. Do not attempt to open the oven door while it is locking. This can ruin the door lock mechanism.
3. Once locked, **DOOR** and the lock icon will stop flashing and **Loc** remains visible in the display.

To reactivate normal oven operation:

1. Press and hold **lock icon** for 3 seconds.
2. After 3 seconds, **door Loc** will appear, a tone will sound, and the word **DOOR** and the lock icon will flash in the display until the oven door has completely unlocked.
3. The oven door can be opened and the oven controls becomes available when the <DOOR> item with a padlock icon disappears from the display.

Oven Light

The oven light will turn on automatically when the oven door is opened. The oven light may be turned on when the door is closed by using the oven light key on the control panel. The light will stay off until the door unlocks.

To toggle the oven lights on and off:

1. Press .
2. The interior oven lights are covered with a glass shield. The glass shield must be in place whenever the oven is in use. To change the interior oven lights, see ["Replacing the oven light" on page 31](#).

SETTING OVEN CONTROLS

Setting Bake

The **Bake** function cooks the food with the heat that rises from the bottom of the oven. Heat and air circulate naturally in the oven. An audible reminder indicates that the cooking temperature is reached and to place the food in the oven.

The **Bake** function can be set at oven temperatures ranging from 77 to 288 ° C (170 to 550 ° F).

Baking Tips

- For best results when baking cakes using two oven racks, place racks in positions 2 and 4 (See [Figure 2](#)).
- When baking using two oven racks, position cookware as shown in [Figure 3](#).

CAUTION

Always wear mitts to use the oven. When cooking, the inside and outside of the oven, and grills become very hot; This can cause burns.

To set the bake temperature to 350°F:

1. Press **Bake**.
2. **350** will appear in the display.
3. Press **START**.

To turn off the oven at any time press OFF.

To change the bake temperature (example: changing from 375°F to 425°F) while baking:

1. Press **Bake**.
2. Press **4 2 5** to enter new temperature.
3. Press **START**.

To turn off the oven at any time press **OFF**.

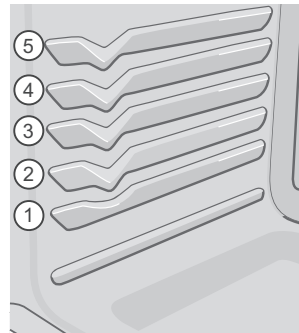

Figure 2: Rack positions

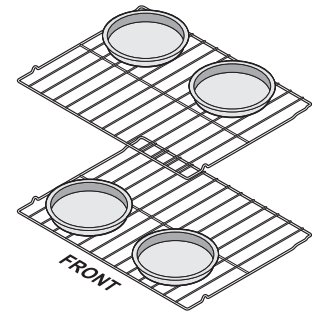

Figure 3: Pan spacing

SETTING OVEN CONTROLS

Setting Bake Time

Use Bake Time when setting the oven to cook for a specific length of time and shut off automatically when the time is complete.

When cooking time ends, the oven will shut off and will beep. This feature can be used with Bake, convection bake, convection roast, and slow cook modes.

To program the oven to begin baking immediately and to shut off automatically (example: Bake at 350°F for 30 minutes):

1. Be sure the clock is set for the correct time of day.
2. Arrange interior oven rack(s) and place the food in then oven.
3. Press **Bake. 350** will appear in the display.
4. Press **START**. The actual oven temperature will appear in the display.
5. Press **Bake Time. -- --** will appear in the display.
6. Enter the desired baking time by pressing **3 0**.
7. Press **START**. Once the timed Bake feature has started, the current time of day will appear in the display.

Press **OFF** when baking has finished or at any time to cancel the Bake Time feature. A bake time of **0** minute can also be entered to cancel the Bake Time feature and keep the oven in its current cooking mode. When the timed bake finishes:

1. **End** and the time of day will show in display. The oven will shut off automatically.
2. The control will beep three times. The control will continue to beep three times every 30 seconds until **OFF** is pressed.

NOTE

Baking time can be set for any amount of time between 1 minute to 11hrs and 59 minutes. The time remaining can be shown in the timer section of the display by pressing **Bake Time** at any moment of the cooking.

Once Bake Time has started baking, a beep will sound when the oven temperature reaches the set temperature.

Setting Delay Start

CAUTION

Food Poisoning Hazard. Do not let food sit for more than one hour before or after cooking. Doing so can result in food poisoning or sickness. Foods that can easily spoil such as milk, eggs, fish, meat, or poultry should be chilled in the refrigerator first. Even when chilled, they should not stand in the oven for more than 1 hour before cooking begins and should be removed promptly when finished cooking. Always wear oven mitts when using the oven.

Bake, Bake Time, and Delay Start keys control the delayed start feature. The automatic timer of delayed start will turn the oven on and off at the time you select in advance.

To program the oven for a delayed start time with the Bake function. (example: baking at 375°F for 30 minutes, starting at 5:30):

1. Be sure that the clock is set with the correct time of day.
2. Arrange interior oven rack and place the food in the oven.
3. Press **Bake. 350** will appear in the display.
4. Enter the temperature pressing **3 7 5**.
5. Press **START**. The actual oven temperature will appear in the display.
6. Press **Bake Time** and enter **3 0** using numeric keys.
7. Press **START**.
8. Press **Delay Start**.
9. Enter the desired start time by pressing **5 3 0**.
10. Press **START**.

When a delayed baking function starts, the set oven temperature will appear. **Delay, Bake,** and the current time of day will appear in the display. When the desired start time is reached, the actual oven temperature appears in display and **delay** disappears. Oven starts to bake at the previously selected temperature

SETTING OVEN CONTROLS

Setting Broil

Broiling is direct heat cooking and will produce some smoke. If smoke is excessive, place food further away from the element. Watch food to prevent burning.

When broiling, always remember to arrange the oven racks while oven is still cool. Broil with oven door closed.

For optimum browning, preheat the broil element for 2 minutes. Broil one side until the food is browned; turn and cook on the second side. Season and serve

The **Broil** key controls the broil feature. An optional broil pan and broil pan insert used together allow grease to drain away from the high heat of the oven broiler. The oven can be programmed to broil at any temperature from 400°F to 550°F with a default temperature of 550°F.

WARNING

Always wear oven mitts when broiling. Should an oven fire occur, close the oven door and turn the oven off. If the fire continues, use a fire extinguisher. Do not put water or flour on the fire. Flour may be explosive.

Do not use the pan without the insert. Do not cover the insert with aluminum foil; the exposed grease could ignite.

To set a broil of 500°F:

1. Place the broiler pan insert on the broiler pan and place the food on the broiler pan insert. Do not use the broiler pan without the insert. The exposed grease could ignite.
2. Arrange the interior oven rack and place the broiler pan on the rack.
3. Press **Broil**. **550** will appear in the display.
4. Press **5 0 0**. If a lower Broil temperature is desired (minimum broil temperature setting is 400°F), press the desired temperature before continuing to Step 5.
5. Press **START**. The oven will begin to broil. **500°** will appear in the display. Preheat for 2 minutes before broiling. Broil with oven door closed.
6. Center the broiler pan directly under the broiler element. Broil on one side until food is browned; turn and cook on the second side. Season and serve. Always pull the rack out to the stop position before turning or removing food.
7. To stop broiling, press **OFF**.

NOTE

If a broiler pan and insert are not supplied with this appliance they may be purchased from frigidaire.com.

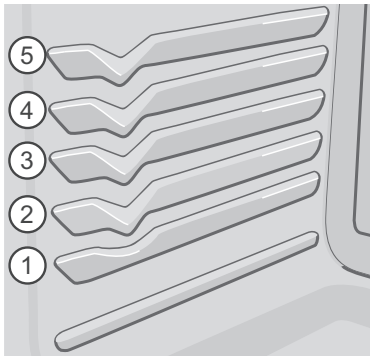

Figure 4: Rack positions

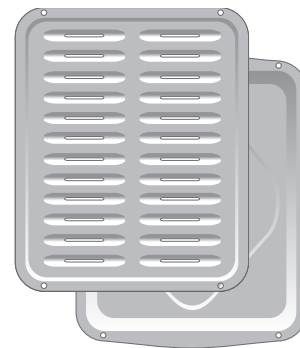

Figure 5: Broil pan and insert

SETTING OVEN CONTROLS

Table 1: Broil recommendations

Food item	Rack Position	Temp	Cook time in minutes		Internal Temperature	Doneness
			1st side	2nd side		
Steak 1" thick	4 or 5	HI(550°F)	6:00	5:00	135°F (57°C)	Rare**
Steak 1" thick	4 or 5	HI(550°F)	7:00	5:00	145°F (63°C)	Medium-well
Steak 1" thick	4 or 5	HI(550°F)	8:00	7:00	170°F (77°C)	Well
Pork Chops 3/4 "thick	4	HI(550°F)	8:00	6:00	170°F (77°C)	Well
Chicken - Bone In	4	LO(400°F)	20:00	10:00	170°F (77°C)	Well
Chicken Boneless	5	LO(400°F)	8:00	6:00	170°F (77°C)	Well
Fish	5	HI(550°F)	13:00	--	170°F (77°C)	Well
Shrimp	4	HI(550°F)	5:00	--	170°F (77°C)	Well
Hamburger 1" thick	5	HI(550°F)	6:00	5:00	135°F (57°C)	Rare**
Hamburger 1" thick	5	HI(550°F)	9:00	7:00	145°F (63°C)	Medium
Hamburger 1" thick	5	HI(550°F)	10:00	8:00	170°F (77°C)	Well

The U.S. Department of Agriculture states, "**Rare fresh beef is popular, but you should know that cooking it to only 140°F (60°C) means some food poisoning organisms may survive." (Source: Safe Food Book, Your Kitchen Guide, USDA Rev. June 1985.) The lowest temperature recommended by the USDA is 145°F (63°C) for medium rare fresh beef. For well done 170°F (77°C). All cook times shown are after 2 minutes of preheating.

SETTING OVEN CONTROLS

Setting Keep Warm

Keep Warm is best for keeping oven baked foods warm for serving after cooking has finished. The **Keep Warm** key turns on the Keep Warm feature, will maintain an oven temperature of 170°F (77°C), and will keep oven baked foods warm for serving up to 3 hours after cooking.

To set Keep Warm:

1. Arrange interior oven racks and place food in oven.
2. Press **Keep Warm**. "HLd" will appear in the display.
3. Press **START**. If **start** is not touched within 25 seconds the request to turn on the Keep Warm feature will be canceled.
4. To turn off the Keep Warm feature at any time, press **OFF**.

To set Keep Warm to turn on automatically:

1. Arrange interior oven racks and place food in oven. Set the oven properly for Bake Time or Delay Start. For Delay Start instructions, see [page 16](#). For Bake Time instructions, see [page 18](#).
2. Press **Keep Warm**. If no key is touched within 25 seconds, the request to turn on the warm feature will be cancelled.
3. Press **START**. HLd will disappear and the temperature will be displayed. The warm mode is set to turn on automatically after timed bake has finished.
4. To turn the warm feature off at any time, press **OFF**.

Important: After 3 hours, the Keep Warm feature will shut the oven off. The Keep Warm feature may be used without any other cooking operations or can be set to turn on automatically after a Bake Time or Delay Start

Adjusting Oven Temperature

The temperature in the oven is pre-set at the factory. When first using the oven, be sure to follow recipe times and temperatures. If you think the oven is cooking too hot or too cool for the temperature you select, you can adjust the actual oven temperature to be more or less than what is displayed.

Before adjusting, test a recipe by using a temperature setting higher or lower than the recommended temperature. The baking results should help you to decide how much of an adjustment is needed.

Do not use oven thermometers such as those found in grocery stores. The temperatures can vary as much as 20 to 40 degrees.

To adjust the oven temperature higher:

1. Press **Bake** for 6 seconds. **UPO 0** will appear in the display.
2. To increase the temperature, use the number keys to enter the desired change. For 20°F, press **2 0**. To set the oven for -20 °, press **Self Clean** to toggle between **+** and **-**.
3. Press **START** to accept the temperature change and the display will return to the time of day.

Oven temperature adjustments do not affect Broil, Self Clean or Keep Warm functions.

The oven temperature settings can be made even if your oven displays temperatures in ° C (Celsius). Maximum and minimum settings in Celsius range from plus (+) 19 ° C to minus (-) 19 ° C.

SETTING OVEN CONTROLS

Setting the Sabbath Feature (For use on the Jewish Sabbath and Holidays)

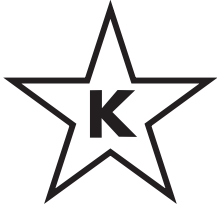

The **Bake Time** and **Delay Start** keys are used to set the Sabbath feature.

For further assistance, guidelines for proper usage, and a complete list of models with the Sabbath feature, please visit the web at <http://www.star-k.org>.

The Sabbath feature may only be used with the Bake function. Once the oven is properly set using Bake with the Sabbath feature active, the oven will remain on until cancelled. The Sabbath feature overrides the factory preset 12 hour energy saving feature.

If the oven light is needed during the Sabbath, press **Oven light** before activating the Sabbath feature. Once the oven light is turned on and the Sabbath feature is active, the oven light will remain on until the Sabbath feature is turned off. If the oven light needs to be off, be sure to turn the oven light off before activating the Sabbath feature.

→ IMPORTANT

It is advised to not activate any cooking function other than Bake while the Sabbath feature is active.

To program the oven to begin baking immediately and activate the Sabbath feature (example: baking at 350°F):

1. Be sure that the clock is set with the correct time of day.
2. Place the food in the oven. Press **Bake**. **350°** appears in the display. Press **START**. The actual oven temperature appears in the display.
3. If you desire to set the oven control for a Bake Time or delayed Bake Time, do so at this time. If not, skip this step and continue to Step 5. For Delay Start instructions, see [page 16](#). For Bake Time instructions, see [page 18](#). Remember the oven will turn off after using Bake Time or Delay Start and may only be used once during the Sabbath/Jewish holidays. The maximum bake time is 5 hours and 59 minutes.
4. The oven will turn on and begin heating.

5. Press and hold both the **Bake Time** and **Delay Start** keys for at least 3 seconds. **SAb** will appear in the display. Once **SAb** appears in the display, the oven control will no longer beep or display any further changes, and the oven is properly set for the Sabbath feature.
6. The oven may be turned off at any time by first pressing **OFF** (this will turn the oven off only).
7. To turn off the Sabbath feature, press and hold both the **Bake Time** and **Delay Start** keys for at least 3 seconds. **SAb** will disappear from the display.

📌 NOTE

You may change the oven temperature once baking has started by pressing **Bake** and the numeric keys for the new temperature. For example, to change from 350°F to 425°F, press **4 2 5**. Then, press **START** twice.

Only the following controls will function after setting the Sabbath feature: numeric keypad, Bake, START, and off. All other features will not function once the Sabbath feature is properly activated.

The display will not show temperature changes or sound any audible tones when the oven is set with the Sabbath feature

Power failure while using Sabbath feature:

Should you experience a power failure or interruption, the oven will shut off. When power is returned, **SF** (Sabbath Failure) will be displayed, and the oven will not turn back on automatically. If your food was nearly fully cooked, you may allow the trapped heat in the oven to finish the cooking process. Otherwise, you should remove the food when the power failure occurs because you may only start the oven once during the Sabbath/Jewish holidays.

After the Sabbath observance turn off the Sabbath feature. Press and hold both the **Bake Time** and **Delay Start** keys for at least 3 seconds. **SAb** will disappear from the display and the oven may be used with all normal functions.

SETTING OVEN CONTROLS

Self Cleaning

A self-cleaning oven cleans itself with high temperatures (well above normal cooking temperatures) which eliminate soils completely or reduces them to a fine powdered ash you can wipe away with a damp cloth. Self clean may be programmed for 2 to 4 hours depending on the need for deep cleaning.

Important: Please read all safety instructions and statements before starting self clean.

CAUTION

To avoid possible burns, use care when opening the oven door after the clean cycle. Stand to the side of the oven when opening the door to allow hot air or steam to escape.

Do not leave small children unattended near the appliance during a clean cycle; the range may become very hot to the touch.

Do not line the oven walls, racks, bottom, or any other part of the oven with aluminum foil. Doing so will block heat distribution, produce poor baking results, and cause permanent damage to the oven interior (aluminum foil will melt to the interior surface of the oven).

The health of some birds is extremely sensitive to the fumes given off during the self-cleaning cycle of any oven. Move birds to another well-ventilated room.

Do not force the oven door open. This can damage the automatic door locking system.

Important:

- Do not use oven cleaners or protective coatings in or around any part of the oven interior. Do not clean the oven door gasket. Take care not to rub, damage, or remove the gasket or use any cleaning substances on the oven door gasket (See [Figure 6](#)). Doing so could cause damage and reduce the efficiency of the oven's performance.
- Clean any soil from the oven frame, door liner outside the oven door gasket, and the small area at the front center of the oven bottom with soap and water (See [Figure 6](#)). These areas heat sufficiently to burn soil on.
- Remove any excessive spills from the oven cavity before starting the self-cleaning cycle. To clean, use hot, soapy water and a cloth. Large spills can cause heavy smoke or fire when subjected to high temperatures. Do not allow food spills with a high sugar or acid content (such as milk, tomatoes, sauerkraut, fruit juices, or pie filling) to remain on the surface as they may leave a dull spot even after cleaning.
- Do not use aluminum foil or liners in the oven. These items are not made to withstand the very high temperatures of a self-clean cycle and will melt.
- Remove all oven racks and accessories. If oven racks are not removed before a self-clean, they will lose their special coating and will no longer slide in and out of the oven cavity effortlessly.
- Oven racks accidentally left in the oven during Self Clean may be wiped down after cooling with a high-temperature cooking oil to lubricate them.
- Do not attempt to open the oven door while it is locking. This can ruin the door lock mechanism. Wait a full 15 seconds until the door lock icon stops flashing before opening the door

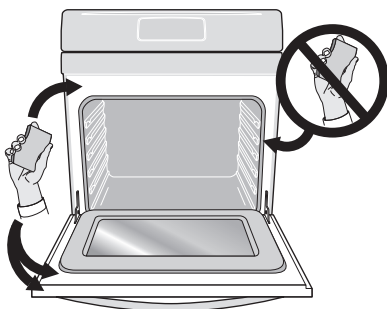

Figure 6: Clean around the oven door gasket

SETTING OVEN CONTROLS

Setting Self-Clean Cycle Duration

The **Self Clean** key controls the self-cleaning feature. If you are planning to use the oven directly after a self-clean cycle remember to allow time for the oven to cool down and the oven door to unlock. This normally takes about one hour. A 3 hour self-clean cycle will actually take about 4 hours to complete.

It is recommended to use a 2 hour self-clean cycle for light soils, a 3 hour cycle for average soils, and a 4 hour cycle for heavy soils.

To set the controls for a 3 hour self-cleaning cycle to start immediately and shut off automatically:

1. Be sure the clock is set with the correct time of day and the oven door is closed.
2. Press **Self Clean**. **CLn** and **3:00 HR** will show in the display. The control will automatically clean for a 3 hour period (default self-cleaning cycle time).
3. Press **START**. **door Loc** will appear, a beep will sound, and the word **DOOR** and the (lock icon) will flash; **CLn** will remain on in the display.
4. As soon as the control is set, the motor driven oven door lock will begin to close automatically. Once the door is locked, the **DOOR** indicator light and lock icon will stop flashing and remain on, and the oven icon will appear in the display. Allow about 15 seconds for the oven door to lock completely.

When the self-clean cycle is completed:

1. **HOT** will appear in the display. The time of day, the word **DOOR**, and the lock icon will remain in the display.
2. Once the oven has cooled for approximately 1 hour, **door OPn** will appear, and the word **DOOR** and the lock icon will flash until the door unlocks. The door can be opened, and the display will show the time of day.

To stop or Interrupt a self-cleaning cycle:

If it becomes necessary to stop or interrupt a self-cleaning cycle due to excessive smoke or fire in the oven:

1. Press **OFF**.
2. The oven door can only be opened after the oven has cooled down for about 1 HOUR. **door OPn** will appear, and the word **DOOR** and the lock icon will flash until the door is unlocked. The oven door can then be opened, and the timer will revert back to the time of day.

The **Self Clean** and **Delay Start** keys control the delayed self-clean operation. The automatic timer will turn the oven on and off at the time you select in advance.

To set the control for the self-cleaning cycle to start at a delayed time and shut off automatically (example: 3 hour self-clean cycle to start at 4:30):

1. Be sure the clock is set with the correct time of day and the oven door is closed.
2. Press **Self Clean**. **CLn** and **3:00 HR** will show in the display. The control will automatically clean for a 3 hour period. If a 2 or 4 hour clean time is desired, press **Self Clean** multiple times to toggle between 2, 3, or 4 hours.
3. Press **START**. **door Loc** will appear, a beep will sound, and the word **DOOR** and the lock icon will flash. The letters **CLn** will remain on in the display.
4. As soon as the control is set, the motor driven oven door lock will begin to close automatically. Once the door has been locked, the word **DOOR** and the lock icon indicator light will quit flashing and remain on.
5. Press **delay START**. Enter the desired start time using the number keys **4 3 0**.
6. Press **START**. **DELAY**, **DOOR**, and the lock icon will remain on.
7. The control will start the self-cleaning at the set start time for the period of time previously selected. At that time, the icon **DELAY** will go out; **CLn** and oven icon will appear in the display.

When the self-clean cycle is completed:

1. **HOT** will appear in the display. The time of day, the word **DOOR**, and the lock icon will remain in the display.
2. When oven cools approximately 1 HOUR, **door OPn** will appear, and the word **DOOR** and the lock icon will flash until the door is unlocked. The oven door can then be opened, and the timer will revert back to the time of day.

Cleaning Various Parts of Your Oven

Before cleaning any part of the oven, be sure all controls are turned off and the oven is cool. Remove spills and any heavy soiling as soon as possible. Regular cleaning will reduce the number of major cleaning later.

CAUTION

- Before cleaning any part of the appliance, be sure all controls are turned off and the appliance is cool.
- If ammonia or appliance cleaners are used, they must be removed and the appliance must be thoroughly rinsed before operating. Follow manufacturer's instructions and provide adequate ventilation.

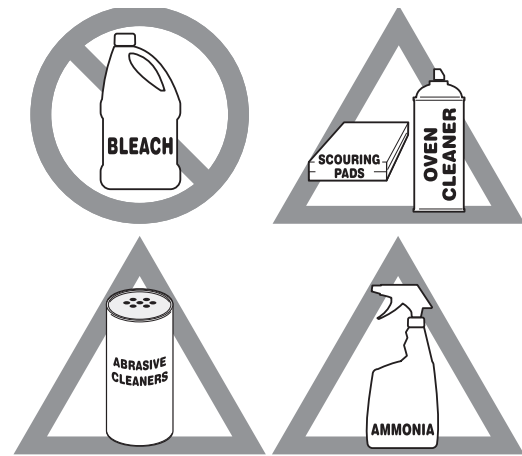

Figure 7: Use cleaners with caution

Surface or Area	Cleaning Recommendation
Aluminum and vinyl	Using a soft cloth, clean with mild dish detergent and water. Rinse with clean water, dry and polish with a soft, clean cloth.
Painted and plastic control knobs Painted body parts Painted decorative trims	Using a soft cloth, clean with mild dish detergent and water or a 50/50 solution of vinegar and water. Rinse with clean water, dry and polish with a soft, clean cloth. Glass cleaners may be used, but do not apply directly to surface; spray onto cloth and wipe.
Control panel	Using a soft cloth, clean with mild dish detergent and water or a 50/50 solution of vinegar and water. Do not spray liquids directly on the oven control and display area. Do not use large amounts of water on the control panel - excess water on the control area may cause damage to the appliance. Do not use other liquid cleaners, abrasive cleaners, scouring pads, or paper towels - they will damage the finish.
Control knobs	Using a soft cloth, clean with mild dish detergent and water or a 50/50 solution of vinegar and water. To remove control knobs: turn to the OFF position, grasp firmly, and pull off the shaft. To replace knobs after cleaning, line up the OFF markings and push the knobs into place.
Stainless Steel	Using a soft cloth, clean with mild dish detergent and water or a 50/50 solution of vinegar and water. Rinse with clean water, dry with a soft clean cloth. Do not use cleaners containing abrasives, chlorides, chlorine, or ammonia.
Smudge Proof™ Stainless Steel Black Stainless Steel	Using a soft cloth, clean with mild dish detergent and water or a 50/50 solution of vinegar and water. Rinse with clean water, dry with a soft clean cloth. Do not use appliance cleaner, stainless steel cleaner, or cleaner containing abrasives, chlorides, chlorine, or ammonia. These cleaners may damage the finish.
Porcelain-enameled broiler pan and insert Porcelain door liner Porcelain body parts	Rinse with clean water and a damp cloth. Scrub gently with a soapy, non-abrasive scouring pad to remove most spots. Rinse with a 50/50 solution of clean water and ammonia. If necessary, cover difficult spots with an ammonia-soaked paper towel for 30 to 40 minutes. Rinse and wipe dry with a clean cloth. Remove all cleaners or future heating could damage the porcelain. Do not allow food spills with a high sugar or acid content (milk, tomatoes, sauerkraut, fruit juices or pie filling) to remain on porcelain surfaces. These spills may cause a dull spot even after cleaning.

CARE AND CLEANING

Self-cleaning oven interior

Before setting a self-clean cycle, clean soils from the oven frame, areas outside the oven door gasket, and the small area at the front center of the oven bottom. See [“Self Clean”](#) on [page 23](#).

Oven door

Use mild dish detergent and water or a 50/50 solution of vinegar and water to clean the top, sides, and front of the oven door. Rinse well. Glass cleaner may be used on the outside glass of the door. Ceramic smoothtop cleaner or polish may be used on the interior door glass. Do not immerse the door in water. Do not spray or allow water or cleaners to enter the door vents. Do not use oven cleaners, cleaning powders, or any harsh abrasive cleaning materials on the outside of the oven door.

Do not clean the oven door gasket. The oven door gasket is made of a woven material which is essential for a good seal. Do not rub, damage, or remove this gasket.

CARE AND CLEANING

General Cleaning

Refer to the table at the beginning of this chapter for more information about cleaning specific parts of the oven.

CAUTION

Before manually cleaning any part of the oven, be sure all controls are turned off and the oven is cool. The oven may be hot and can cause burns.

Remove all racks and accessories from the oven before cleaning.

Ammonia must be rinsed before operating the oven. Provide adequate ventilation.

Follow these cleaning precautions:

- Allow the oven to cool before cleaning.
- Wear rubber gloves when cleaning the appliance manually.

Remove soils using hot, soapy water. Do not allow food spills with a high sugar or acid content (such as milk, tomatoes, sauerkraut, fruit juices or pie filling) to remain on the surface as they may cause a dull spot even after cleaning. Remove spillovers and heavy soiling as soon as possible. Regular cleaning will reduce the effort required for major cleaning later.

Boiler Pan Cleaning Tips

To prevent grease from baking on, remove the broiler pan from the oven as soon as cooking is completed. Use oven mitts because the broiler pan is extremely hot. Pour off grease. Soak the pan in hot, soapy water.

Clean the broiler pan as soon as possible after each use. If necessary, use soap-filled steel wool pads. Heavy scouring may scratch the grid.

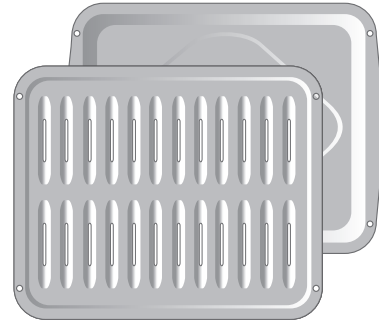

Figure 8: Broiler pan with insert

CARE AND CLEANING

Aluminum Foil, Aluminum Utensils, and Oven Liners

⚠ WARNING

Never cover any slots, holes, or passages in the oven bottom or cover an entire oven rack with materials such as aluminum foil. Doing so blocks air flow through the oven and may cause carbon monoxide poisoning. Aluminum foil linings may trap heat, causing a fire hazard.

Protective liners—Do not use aluminum foil to line the oven bottom. The high heat of the oven can melt these materials to the oven cavity and ruin the oven. These types of materials can also reduce the effectiveness of the air circulation in the oven and produce poor baking results. Only use aluminum foil as recommended in this manual. Improper installation of these liners may result in risk of electric shock or fire.

- Aluminum utensils - The melting point of aluminum is much lower than that of other metals. Care must be taken when aluminum pots or pans are used.
- Oven racks - Do not use aluminum foil to cover the oven racks. Using a liner in the oven restricts the heat and air flow needed to obtain the best possible cooking results for any oven.

Replacing the Oven Light

⚠ CAUTION

Be sure the oven is unplugged and all parts are cool before replacing the oven light.

The interior oven light is located at the rear of the oven cavity and is covered by a glass shield. The glass shield must be in place whenever the oven is in use (Figure 9).

To replace the oven interior light bulb:

1. Turn electrical power off at the main source or unplug the appliance.
2. Remove interior oven light shield by turning a quarter turn counter-clockwise.
3. Replace bulb with a new T-4 type Halogen 25 watt appliance bulb.

📌 NOTE

Wear a cotton glove or use a paper towel when installing a new bulb. Do not touch the new bulb with your fingers when replacing. This will shorten the life of the bulb.

4. Replace glass oven light shield by rotating clockwise.
5. Turn power back on again at the main source (or plug the appliance back in).
6. Be sure to reset the time of day on the clock

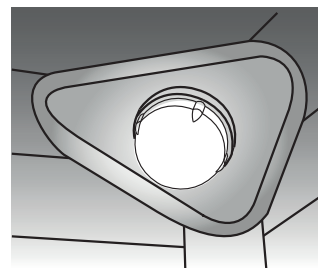

Figure 9: Wall oven Halogen light

Removing and Replacing the Oven Door

→ IMPORTANT

Special door care instructions - The door is heavy. For safe, temporary storage, lay the door flat with the inside of the door facing down.

Most oven doors contain glass that can break. Do not close the oven door until all the oven racks are positioned correctly in the cavity. Do not hit the glass with bakeware or any other objects. Scratching, hitting, jarring, or stressing the glass may weaken its structure, causing an increased risk of breakage at a later time.

To remove the oven door:

1. Open oven door completely, horizontal with floor.
2. Pull up the lock located on each hinge support toward front of the oven until the lock stops. You may have to apply a little upward pressure on the lock to pull it up (Figure 11 and Figure 12).
3. Grasp the door by the sides, and close the door until the door frame makes contact with the unlocked hinges.
4. Pull the bottom of the door toward you while rotating the top of the door toward the appliance to completely disengage the hinge levers (Figure 13).

To Replace Oven Door:

1. Firmly grasp both sides of oven door along the door sides. Do not use the oven door handle (Figure 13).
2. Hold the oven door at the same angle as the removal position. Carefully insert the hinge levers into the oven frame until you feel the hinge levers are seated into the hinge notches. The hinge arms must be fully seated into the hinge notches before the oven door can be fully opened. (Figure 13).
3. Fully open the oven door, horizontal with floor (Figure 10).
4. Push the door hinge locks up toward and into the oven frame on both left and right oven door hinges to the locked position (Figure 11).
5. Close the oven door.

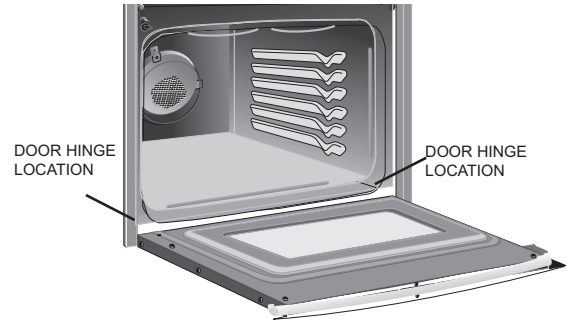

Figure 10: Door hinge location

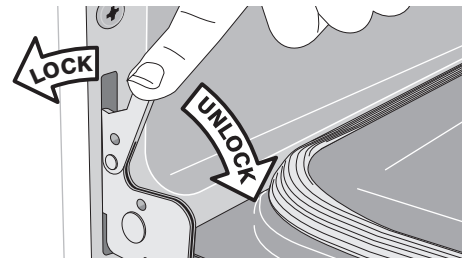

Figure 11: Door hinge locked

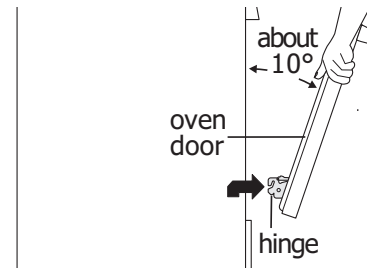

Figure 12: Unlocking door hinge

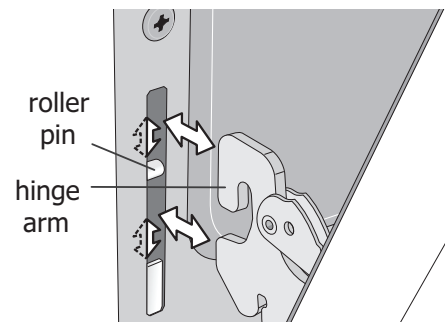

Figure 13: Remove door position

BEFORE YOU CALL





Solutions to Common Baking Problems

For best cooking results, fully preheat the oven before baking cookies, breads, cakes, pies or pastries, etc.

There is no need to preheat the oven for roasting meat or baking casseroles.

The cooking times and temperatures needed to bake a product may vary slightly from your previously owned appliance.

Baking Problems and Solutions Chart

Baking Problems	Causes	Corrections
Cookies and biscuits burn on the bottom. 	<ul style="list-style-type: none"> • Cookies and biscuits put into oven before the preheating time is completed. • Oven rack is overcrowded. • Dark pans absorb heat too fast. 	<ul style="list-style-type: none"> • Allow oven to preheat to desired temperature before placing food in oven, • Choose pan sizes that will permit 2 to 4 inches (5.1 to 10.2 cm) space on all sides when placed in the oven. • Use a medium weight baking sheet.
Cakes too dark on top or bottom. 	<ul style="list-style-type: none"> • Cakes put in oven before preheating time is completed. • Rack position too high or too low. • Oven too hot. 	<ul style="list-style-type: none"> • Allow oven to preheat to the selected temperature before placing food in the oven. • Use proper rack position for baking needs. • Set oven temperature 25°F (13°C) lower than recommended.
Cakes not done in center. 	<ul style="list-style-type: none"> • Oven too hot. • Incorrect pan size. • Pan not centered in oven. 	<ul style="list-style-type: none"> • Set oven temperature 25°F (13°C) lower than recommended. • Use pan size suggested in recipe. • Use proper rack position and place pan to allow for 2 to 4 inches (5.1 cm to 10.2 cm) space on all sides of pan.
Cakes not level. 	<ul style="list-style-type: none"> • Oven not level. • Pan too close to oven wall or rack overcrowded. • Pan warped. • Oven light left on while baking. 	<ul style="list-style-type: none"> • Place a marked glass measuring cup filled with water on the center of the oven rack. If the water level is uneven, refer to the installation instructions for leveling the oven. • Be sure to allow 2" to 4" (5.1 cm to 10.2 cm) of clearance on all sides of each pan in the oven. • Do not use pans that are dented or warped. • Leave oven light off while baking.
Foods not done when cooking time is over. 	<ul style="list-style-type: none"> • Oven too cool. • Oven overcrowded. • Oven door opened too frequently. 	<ul style="list-style-type: none"> • Set oven temperature 25°F (13°C) higher than suggested and bake for the recommended time. • Be sure to remove all pans from the oven except the ones to be used for baking. • Open oven door only after shortest recommended baking time.

BEFORE YOU CALL

Before you call for service, review the following list. It may save you time and expense.

Possible solutions are provided with the problem listed:

Problem	Solution
Oven control panel beeps and displays error codes	<ul style="list-style-type: none">• Oven control has detected a fault or error condition. When this occurs an E or F will show in the display.• Turn both oven selectors to the OFF position; Activate a Bake or Broil using both the oven mode and temperature selectors.• If the F or E code error repeats, turn off power to appliance, wait 5 minutes and then repower appliance. Set clock with correct time of day.• Try Bake or Broil function again. If a fault code appear again, turn both oven selectors to the OFF position to clear the error code and contact your servicer.
Poor baking results	<ul style="list-style-type: none">• Many factors effect baking results.• Use proper oven rack position.• Center food in the oven and space pans to allow air to circulate.• Preheat oven to the set temperature before placing food in the oven.• Try adjusting the recipe's recommended temperature or baking time. See "Adjusting Oven Temperature" on page 19 if you feel the oven is too hot or cold.
Appliance is not level	<ul style="list-style-type: none">• Poor installation. Place oven rack in center of oven. Place a level on the oven rack to check if oven has been properly installed.• Kitchen cabinet alignment may make oven appear not level. Be sure cabinets are square and have sufficient room for appliance clearance.• If cabinets are not square or are built in too tightly, contact builder or installer to make appliance accessible.
Cannot move appliance easily Appliance must be accessible for service	<ul style="list-style-type: none">• Cabinets not square or are built in too tightly.• Contact builder or installer to make appliance accessible.
Appliance does not operate	<ul style="list-style-type: none">• Electrical power outage. Check house lights to be sure.• Call your local electric company for service outage information.• Service wiring is incomplete. Call 1-800-944-9044 for assistance.
Flames inside oven or smoking from oven vent	<ul style="list-style-type: none">• Excessive spills in oven. Grease or food spilled onto oven bottom or oven cavity. Wipe up excessive spills before starting oven.• If flames or excessive smoke are present when broiling, see "Setting Broil" on page 17.
Oven does not operate.	<ul style="list-style-type: none">• The time of day is not set. The oven clock must first be set in order to operate the oven. See "Setting the Clock" on page 13.• Be sure oven controls are set properly. See "Oven Control Features" beginning on page 12 and review instructions for the desired cooking function in this manual.

BEFORE YOU CALL

Oven smokes excessively when broiling.	<ul style="list-style-type: none">• Incorrect setting. See “Setting Broil” on page 17.• Meat too close to the broil element. Reposition rack to provide proper clearance between the meat and broil element. Remove excess fat from meat. Cut remaining fatty edges to prevent curling, but do not cut into lean.• Grease build up on oven surfaces. Regular cleaning is necessary when broiling frequently. Grease or food splatters will cause excessive smoking.
Oven racks discolored or do not slide easily.	<ul style="list-style-type: none">• Clean by using a mild abrasive cleaner following manufacturer's instructions. Rinse with clean water, dry, and replace in oven..
Oven light does not work.	<ul style="list-style-type: none">• Be sure the oven light is secure in the socket. “See “Replacing the Oven Light” on page 26.
Fan noise occurring after the oven is turned off	<ul style="list-style-type: none">• Some models are equipped with a cooling fan that runs during the cooking process to cool internal electronic components. It is normal for this fan to continue to run for an extended period of time, even when the oven has been turned off.

WARRANTY

Your appliance is covered by a one year limited warranty. For one year from your original date of purchase, Electrolux will pay all costs for repairing or replacing any parts of this appliance that prove to be defective in materials or workmanship when such appliance is installed, used and maintained in accordance with the provided instructions.

Exclusions

This warranty does not cover the following:

1. Products with original serial numbers that have been removed, altered or cannot be readily determined.
2. Product that has been transferred from its original owner to another party or removed outside the USA or Canada.
3. Rust on the interior or exterior of the unit.
4. Products purchased "as-is" are not covered by this warranty.
5. Food loss due to any refrigerator or freezer failures.
6. Products used in a commercial setting.
7. Service calls which do not involve malfunction or defects in materials or workmanship, or for appliances not in ordinary household use or used other than in accordance with the provided instructions.
8. Service calls to correct the installation of your appliance or to instruct you how to use your appliance.
9. Expenses for making the appliance accessible for servicing, such as removal of trim, cupboards, shelves, etc., which are not a part of the appliance when it is shipped from the factory.
10. Service calls to repair or replace appliance light bulbs, air filters, water filters, other consumables, or knobs, handles, or other cosmetic parts.
11. Surcharges including, but not limited to, any after hour, weekend, or holiday service calls, tolls, ferry trip charges, or mileage expense for service calls to remote areas, including the state of Alaska.
12. Damages to the finish of appliance or home incurred during installation, including but not limited to floors, cabinets, walls, etc.
13. Damages caused by: services performed by unauthorized service companies; use of parts other than genuine Electrolux parts or parts obtained from persons other than authorized service companies; or external causes such as abuse, misuse, inadequate power supply, accidents, fires, or acts of God.

DISCLAIMER OF IMPLIED WARRANTIES; LIMITATION OF REMEDIES

CUSTOMER'S SOLE AND EXCLUSIVE REMEDY UNDER THIS LIMITED WARRANTY SHALL BE PRODUCT REPAIR OR REPLACEMENT AS PROVIDED HEREIN. CLAIMS BASED ON IMPLIED WARRANTIES, INCLUDING WARRANTIES OF MERCHANTABILITY OR FITNESS FOR A PARTICULAR PURPOSE, ARE LIMITED TO ONE YEAR OR THE SHORTEST PERIOD ALLOWED BY LAW, BUT NOT LESS THAN ONE YEAR. ELECTROLUX SHALL NOT BE LIABLE FOR CONSEQUENTIAL OR INCIDENTAL DAMAGES SUCH AS PROPERTY DAMAGE AND INCIDENTAL EXPENSES RESULTING FROM ANY BREACH OF THIS WRITTEN LIMITED WARRANTY OR ANY IMPLIED WARRANTY. SOME STATES AND PROVINCES DO NOT ALLOW THE EXCLUSION OR LIMITATION OF INCIDENTAL OR CONSEQUENTIAL DAMAGES, OR LIMITATIONS ON THE DURATION OF IMPLIED WARRANTIES, SO THESE LIMITATIONS OR EXCLUSIONS MAY NOT APPLY TO YOU. THIS WRITTEN WARRANTY GIVES YOU SPECIFIC LEGAL RIGHTS. YOU MAY ALSO HAVE OTHER RIGHTS THAT VARY FROM STATE TO STATE.

If You Need Service

Keep your receipt, delivery slip, or some other appropriate payment record to establish the warranty period should service be required. If service is performed, it is in your best interest to obtain and keep all receipts. Service under this warranty must be obtained by contacting Electrolux at the addresses or phone numbers below.

This warranty only applies in the USA and Canada. In the USA, your appliance is warranted by Electrolux Major Appliances North America, a division of Electrolux Home Products, Inc. In Canada, your appliance is warranted by Electrolux Canada Corp. Electrolux authorizes no person to change or add to any obligations under this warranty. Obligations for service and parts under this warranty must be performed by Electrolux or an authorized service company. Product features or specifications as described or illustrated are subject to change without notice.

USA
1.800.944.9044
Electrolux Home Products, Inc.
10200 David Taylor Drive
Charlotte, NC 28262



Canada
1.800.265.8352
Electrolux Canada Corp.
5855 Terry Fox Way
Mississauga, Ontario, Canada
L5V 3E4