

FRIGIDAIRE

All about the

Use & Care

of your Electric Range

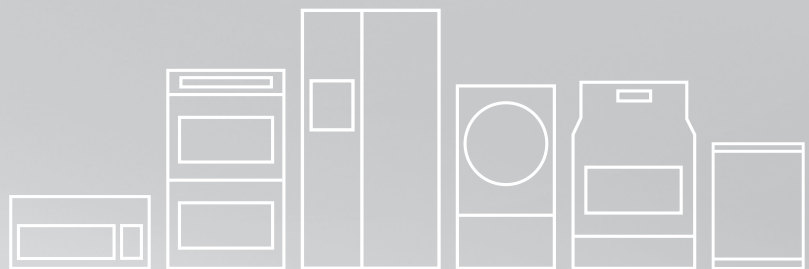

TABLE OF CONTENTS

Important Safety Instructions	3	Setting Oven Controls	16
Cooking Recommendations	8	Care and Cleaning	25
Before Setting Surface Controls	11	Before You Call	31
Setting Surface Controls	14	Warranty	34
Before Setting Oven Controls	15		

PRODUCT RECORD AND REGISTRATION

Need Help?	2
Product Registration	2
Important Safety Instructions	3
Cooking Recommendations	8
Before Setting Surface Controls	11
Setting Surface Controls	14
Before Setting Oven Controls	15
Setting Oven Controls	16
Setting Bake	18
Setting Broil	20
Setting Convection Bake	21
Setting Roast	23
Setting Convection Broil	24
Care and Cleaning	25
Removing and Replacing the Oven Door	29
Oven Baking	31
Before You Call	31
Warranty	34

Need Help?

Visit the Frigidaire web site at www.frigidaire.com

Before you call for service, there are a few things you can do to help us serve you better.

Read this Use & Care Guide

This manual contains instructions to help you use and maintain your appliance properly.

If You Received a Damaged Appliance...

Immediately contact the dealer (or builder) that sold you the appliance.

Save Time and Money

Check "[Solutions to Common Problems:](#)" on page 30. This section helps step you through some common problems that might occur.

If you do need service, help is only a phone call away. Call Frigidaire customer services at **1-800-944-9044**.

Product Registration

Registering your product with Frigidaire enhances our ability to serve you. You can register online at <http://www.frigidaire.com> or by dropping your product registration card in the mail.

Record model and serial numbers here

Purchase Date: _____

Frigidaire model number: _____

Frigidaire serial number: _____

Serial Plate Location

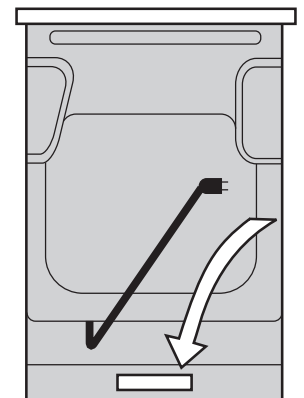
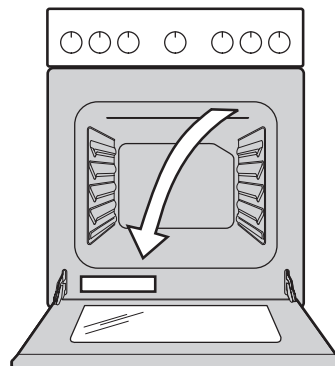

Questions?

For toll-free telephone support in the U.S. and Canada call **1-800-944-9044**

For online support and Internet production information visit <http://www.frigidaire.com>.

Thank you for choosing Frigidaire.

This Use & Care Guide is part of our commitment to customer satisfaction and product quality throughout the service life of your new appliance. We view your purchase as the beginning of a relationship. To ensure our ability to continue serving you, please use this page to record important product information.

IMPORTANT SAFETY INSTRUCTIONS

Read all instructions before using this appliance.

This manual contains important safety symbols and instructions. Please pay attention to these symbols and follow all instructions given.

Do not attempt to install or operate your appliance until you have read the safety precautions in this manual. Safety items throughout this manual are labeled with a WARNING or CAUTION statement based on the risk type.

DEFINITIONS

 Warnings and important instructions appearing in this guide are not meant to cover all possible conditions and situations that may occur. Common sense, caution, and care must be exercised with installing, maintaining, or operating your appliance.

WARNING

Indicates a potentially hazardous situation which, if not avoided, may result in death or serious injury.

CAUTION

Indicates a potentially hazardous situation which, if not avoided, may result in minor or moderate injury.

IMPORTANT

Indicates installation, operation, maintenance, or valuable information that is not hazard related.

NOTE

Indicates a short, informal reference-something written down to assist the memory or for future reference.

WARNING



Tip Over Hazard

- A child or adult can tip the range and be killed.
- Verify the anti-tip device has been installed to floor or wall.
- Ensure the anti-tip device is re-engaged to floor or wall when the range is moved.
- Do not operate the range without the anti-tip device in place and engaged.
- Failure to follow these instructions can result in death or serious burns to children and adults.

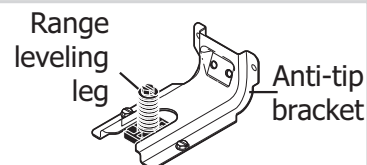

To check if the anti-tip bracket is installed properly, use both arms to grasp the rear edge of the range back. Carefully attempt to tilt range forward. When properly installed, the range should not tilt forward.

Refer to the anti-tip bracket installation instructions supplied with your range for proper installation.

IMPORTANT SAFETY INSTRUCTIONS

IMPORTANT INSTRUCTIONS FOR UNPACKING AND INSTALLATION

IMPORTANT - Read and follow the below instructions and precautions for unpacking, installing, and servicing your appliance:

Remove all tape and packaging before using the appliance. Destroy the carton and plastic bags after unpacking the appliance. Never allow children to play with packaging material. Do not remove the wiring label and other literature attached to the appliance. Do not remove model/serial number plate.

Cold temperatures can damage the electronic control. When using this appliance for the first time, or when the appliance has not been used for an extended period of time, be sure the appliance has been in temperatures above 32°F (0°C) for at least 3 hours before turning on the power to the appliance.

Never modify or alter the construction of the appliance by removing the leveling legs, panels, wire covers, anti-tip brackets/screws, or any other part of the appliance.

Be sure to have an appropriate foam-type fire extinguisher available, visible, and easily accessible located near the appliance.

GROUNDING INSTRUCTIONS

! WARNING

Avoid fire hazard or electrical shock. Failure to follow this warning may cause serious injury, fire, or death.

! WARNING

Avoid fire hazard or electrical shock. Do not use an adapter plug, use an extension cord, or remove grounding prong from the power cord. Failure to follow this warning may cause serious injury, fire, or death.

Proper Installation—Be sure your appliance is properly installed and grounded by a qualified technician. In the United States, install in accordance with the National Fuel Gas Code ANSI Z223.1/NPFA No. 54, latest edition and National Electrical Code NFPA

No. 70 latest edition, and local electrical code requirements. In Canada, install in accordance with CAN/CGA B149.1 and CAN/CGA B149.2 and CSA Standard C22.1, Canadian Electrical code, Part 1-latest editions and local electrical code requirements. Install only per installation instructions provided in the literature package for this appliance.

For personal safety, this appliance must be properly grounded. For maximum safety, the power cord must be securely connected to an electrical outlet or junction box that is the correct voltage, is correctly polarized and properly grounded, and protected by a circuit breaker in accordance with local codes.

It is the personal responsibility of the consumer to have the appropriate outlet or junction box with the correct, properly grounded wall receptacle installed by a qualified electrician. It is the responsibility and obligation of the consumer to contact a qualified installer to assure that the electrical installation is adequate and is in conformance with all local codes and ordinances.

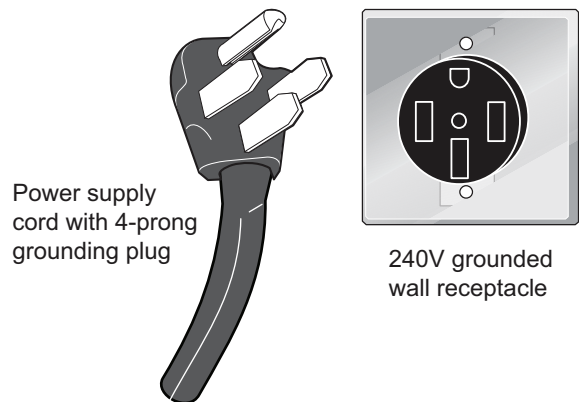

Figure 1: Grounding plug and receptacle

This appliance is equipped with a 4-prong grounding plug for your protection against shock hazard and should be plugged directly into a properly grounded receptacle. Do not cut or remove the grounding prong from this plug.

For personal safety, the appliance must be properly grounded. For maximum safety, the power cord must be plugged into an electrical outlet that is correctly polarized and properly grounded.

IMPORTANT SAFETY INSTRUCTIONS

See the installation instructions packaged with this appliance for complete installation and grounding instructions.

IMPORTANT INSTRUCTIONS FOR USING THE APPLIANCE

WARNING

Storage In or On Appliance—Flammable materials should not be stored in an oven or microwave, near surface burners or elements, or in the storage or warmer drawer (if equipped). This includes paper, plastic, and cloth items, such as cookbooks, plastic ware, and towels, as well as flammable liquids. Do not store explosives, such as aerosol cans, on or near the appliance.

Do not leave children alone - Children should not be left alone or unattended in the area where appliance is in use. They should never be allowed to sit or stand on any part of the appliance, including the storage drawer, lower broiler drawer, warmer drawer, or lower double oven.

Do not store items of interest to children in the cabinets above the appliance or on the backguards of ranges. Children climbing on or near the appliance to reach items could be seriously injured.

Do not allow children to climb or play around the appliance. The weight of a child on an open oven door may cause the appliance to tip, resulting in serious burns or other injury. An open drawer when hot may cause burns.

Stepping, leaning, or sitting on the door or drawers of this appliance can result in serious injuries and also cause damage to the appliance.

Never cover any slots, holes or passages in the oven bottom or cover and entire rack with materials such as aluminum foil. Doing so blocks air flow through the oven and may cause carbon monoxide poisoning. Aluminum foil linings may also trap heat, causing a fire hazard.

WARNING

Do not use oven or warmer drawer (if equipped) for storage.

Never use your appliance as a space heater to heat or warm the room. Doing so may result in carbon monoxide poisoning and overheating of the appliance.

CAUTION

When heating fat or grease, watch it closely. Grease may catch fire if it becomes too hot.

Do not use water or flour on grease fires. Smother fire or flame or use dry chemical or foam-type extinguisher. Cover the fire with a pan lid or use baking soda.

Use dry potholders. Moist or damp potholders on hot surfaces may result in burns from steam. Do not let potholders touch hot cooking areas. Do not use towels or other bulky cloths.

Do not heat unopened food containers - Build-up of pressure may cause container to burst and result in injury.

Wear proper apparel - Loose-fitting or hanging garments should never be worn while using the appliance. Do not let clothing or other flammable materials contact hot surfaces.

Do not touch surface burners or elements, areas near these burners or elements, interior surfaces of the oven, or the warmer drawer (if equipped). Surface burners and elements may be hot even though they appear cool. Areas near surface burners and elements may become hot enough to cause burns. During and after use, do not touch, or let clothing or other flammable materials touch these areas until they are cool. These areas may include the cooktop, surfaces facing the cooktop, oven vent areas, oven door, and oven window.

IMPORTANT SAFETY INSTRUCTIONS

CAUTION

Do not attempt to operate the appliance during a power failure. If the power fails, always turn off the appliance. If the appliance is not turned off and the power resumes, electric surface elements may resume operation when power is restored. Once the power resumes, reset the clock and the oven function.

IMPORTANT INSTRUCTIONS FOR USING YOUR RADIANT COOKTOP

Know which knob or key controls each surface heating area. Place cookware with food on the cooking area before turning it on. Turn the cooking area off before removing the cookware.

Cookware handles should be turned inward and not extend over adjacent surface elements — To reduce the risk of burns, ignition of flammable materials, and spillage due to unintentional contact with the utensil, the handle of the cookware should be positioned so that it is turned inward, and does not extend over other cooking areas.

Use proper pan size - This appliance is equipped with one or more surface units of different sizes. Select cookware with flat bottoms that match the surface unit size. Using the proper cookware on the cooking area will improve efficiency.

Glazed cooking utensils— Only certain types of glass, glass/ceramic, ceramic, earthenware, or other glazed utensils are suitable for cooktop service without breaking due to the sudden change in temperature. Check the manufacturer's recommendations for cooktop use.

Improper cookware may break due to sudden changes in temperature. Check the cookware manufacturer's recommendations for cooktop use.

Never leave surface elements unattended. Boil-overs may cause smoking and greasy spills that may ignite. A pan that has boiled dry could be damaged and may damage the cooktop.

Do not use a searing grill meant for use with a broiler pan on the cooktop. The searing grill is not designed for use on the cooktop. Doing so may result in a fire.

When you are flaming foods under a ventilating hood, turn on the fan.

IMPORTANT INSTRUCTIONS FOR USING YOUR COIL COOKTOP

Make sure reflector pans or drip bowls are in place - absence of these pans or bowls during cooking may subject wiring or components underneath to damage.

Carefully check the reflector pans, drip bowls, and coils for packaging material. Remove all packaging material before using the cooktop.

Protective Liners - Do not use aluminum foil to line surface drip bowls. Improper use of these liners may result in a risk of electric shock or fire.

Do not immerse or soak removable heating elements—Heating elements should never be immersed in water. Heating elements clean themselves during normal operation.

Do not use decorative surface burner covers. If an element is accidentally turned on, the decorative cover will become hot and possibly melt. Burns will occur if the hot covers are touched. Damage may also be done to the cooktop.

Do not allow grease to accumulate around surface burners and drip bowls.

IMPORTANT INSTRUCTIONS FOR USING YOUR OVEN

Protective liners—Do not use aluminum foil, after-market oven liners, or any other materials or devices to line oven bottom, oven racks, or any other part of the appliance. Only use aluminum as recommended for baking, such as lining cookware or as a cover placed on food. Any other use of protective liners or aluminum foil may result in a risk of electric shock or fire or a short circuit.

Use care when opening oven door, lower oven door, or warmer drawer (some models). Stand to the side of the appliance when opening the door of a hot oven.

IMPORTANT SAFETY INSTRUCTIONS

Let hot air or steam escape before you remove or replace food in the oven.

Keep oven vent ducts unobstructed. Touching surfaces in this area when the oven is on may cause severe burns. Do not place plastic or heat-sensitive items on or near the oven vent. These items can melt or ignite.

Placement of oven racks - Always place oven racks in desired location while oven is cool. If rack must be moved while oven is hot, do not let potholder contact hot burner or element in oven. Use potholders and grasp the rack with both hands to reposition. Remove all cookware and utensils before moving the rack.

Do not use a broiler pan without its insert. Broiler pans and inserts allow dripping fat to drain away from the high heat of the broiler. Do not cover the broiler insert with aluminum foil; exposed fat and grease could ignite.

Do not cook food on the oven bottom. Always cook in proper cookware and always use the oven racks.

IMPORTANT INSTRUCTIONS FOR CLEANING YOUR APPLIANCE

CAUTION

Before manually cleaning any part of the appliance, be sure all controls are turned off and the appliance is cool. Cleaning a hot appliance can cause burns.

Clean the appliance regularly to keep all parts free of grease that could catch fire. Do not allow grease to accumulate. Greasy deposits in the fan could catch fire.

Always follow the manufacturer's recommended directions for use of kitchen cleaners and aerosols. Be aware that excess residue from cleaners and aerosols may ignite causing damage and injury.

Clean ventilating hoods frequently - Grease should not be allowed to accumulate on hood or filter. Follow the manufacturer's instructions for cleaning vent hoods.

IMPORTANT INSTRUCTIONS FOR SERVICE AND MAINTENANCE

Do not repair or replace any part of the appliance unless specifically recommended in the manuals. All other servicing should be done only by a qualified technician. This reduces the risk of personal injury and damage to the appliance.

Always contact your dealer, distributor, service agent, or manufacturer about problems or conditions you do not understand.

Ask your dealer to recommend a qualified technician and an authorized repair service. Know how to disconnect the power to the appliance at the circuit breaker or fuse box in case of an emergency.

Remove the oven door from any unused oven if it is to be stored or discarded.

Do not touch a hot oven light bulb with a damp cloth. Doing so could cause the bulb to break. Handle halogen lights (if equipped) with paper towels or soft gloves. Disconnect the appliance or shut off the power to the appliance before removing and replacing the bulb.

WARNING

California Residents: for cancer and reproductive harm information, visit www.P65Warnings.ca.gov

COOKING RECOMMENDATIONS

Bakeware

The material of bakeware affects how evenly and quickly it transfers heat from the pan to the food.

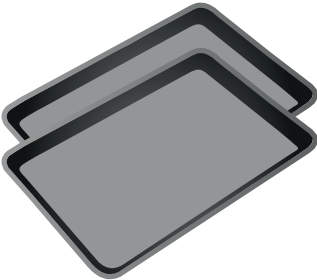
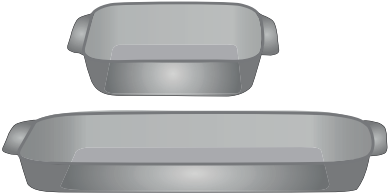
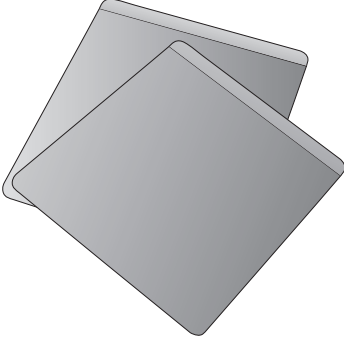
Material	Attributes	Recommendation
Shiny metal bakeware 	Shiny, aluminum, and non-coated bakeware is the best for even heating. It is suitable for all baked goods.	Recommended cooking temperatures and times are based on shiny metal bakeware.
Dark metal bakeware 	Dark bakeware cooks hotter than shiny bakeware.	Reduce the cooking temperature by 25° F (13-14° C) when using dark bakeware.
Glass bakeware 	Glass bakeware cooks hotter than shiny bakeware. Glass is convenient, as the same piece of bakeware can be used for cooking, serving, and storing food.	Reduce the cooking temperature by 25° F (13-14° C) when using glass bakeware.
Insulated bakeware 	Insulated bakeware cooks cooler than shiny bakeware. Insulated bakeware is designed for baking in gas ovens.	Increase the cooking temperature by 25° F (13-14° C) when using insulated bakeware.

COOKING RECOMMENDATIONS

Cooking Conditions

Conditions in your kitchen can affect the performance of your appliance when cooking food.

Condition	Attributes	Recommendation
Aging cookware	As pans age and become discolored, cooking times may need to be reduced slightly.	If food is too dark or overcooked, use the minimum cook time in the recipe or packaging. If food is too light or undercooked, use the middle to maximum cook time in the recipe or packaging.
High altitude	Air is drier and air pressure is lower. Water boils at a lower temperature, and liquids evaporate faster. Foods may take longer to bake. Doughs may rise faster.	Adjust cooking temperature, cooking time, or recipes as needed. Increase amount of liquid in baking recipes. Increase cook time on cooktop. Cover dishes to reduce evaporation. Increase bake time or oven temperature. Reduce amount of baking soda or baking powder in recipe. Reduce rising time or punch down dough and allow it to rise twice.

Cooking Results

Small adjustments may fix a problem with food not being as done as you like or more done than you like.

Result	Recommendation
Food too light	Use the middle to maximum cook time recommended on packaging or recipe.
Food too dark	Use the minimum cook time recommended on packaging or recipe.

Cooking Tips

Use these additional tips to get the best results from your appliance.

Cooking	Tips
Baking	
Rack placement	Follow the instructions in “Setting Oven Controls” on starting on page 16 . When using only one rack, place the rack so the food is in the center of the oven.
Preheat	Fully preheat the oven before baking items like cookies, cakes, biscuits and breads. Insert food immediately after the beep.
Checking food	Use the window and oven light when checking food. Opening the door may reduce baking performance.
Bake or Convection Bake	Convection bake is the best function to use for baking on multiple racks. For best performance, see “Setting Convection Bake” on page 21 .

COOKING RECOMMENDATIONS

Cooking	Tips
Food placement	Allow at least 2 inches (5 cm) of space between bakeware for proper air circulation.
Broiling / Roasting	
Broiling pan	<p>For best results when broiling, use a broil pan with a broil pan insert designed to drain the fat from the food, help avoid spatter, and reduce smoking. The broiler pan will catch grease spills, and the insert helps prevent grease splatters.</p> <p>If a broiler pan and insert are not supplied with this appliance, they may be purchased from Frigidaire.com.</p>
Convection Cooking	
Convection attributes	<p>Convection cooking uses a fan to circulate hot air around the oven and food. It browns food more evenly and reduces hot spots in the oven.</p> <p>Convection saves time when using multiple racks or cooking several food items at once.</p>
Convection bake	<p>Reduce cooking temperature by 25° F (13-14° C) from the recipe unless the recipe is written for convection baking.</p> <p>Preheat the oven for best results.</p>
Convection broil	<p>Reducing the cooking temperature for convection broil is not recommended.</p> <p>Broiling is direct heat cooking and will produce some smoke. If smoke is excessive, move the food farther from the broiler element.</p>

BEFORE SETTING SURFACE CONTROLS

Using Proper Cookware

The size and type of cookware used will influence the radiant element power level setting needed for best cooking results. Be sure to follow the recommendations for using proper cookware as illustrated in [Figure 2](#) and [Figure 3](#).



Figure 2: Testing cookware

Check for flatness by rotating a ruler across the bottom of the cookware ([Figure 2](#)). Cookware should have flat bottoms that make good contact with the entire surface heating element ([Figure 3](#)). For detailed information about the ceramic cooktop, refer to the “[General Cleaning](#)” on [page 28](#).

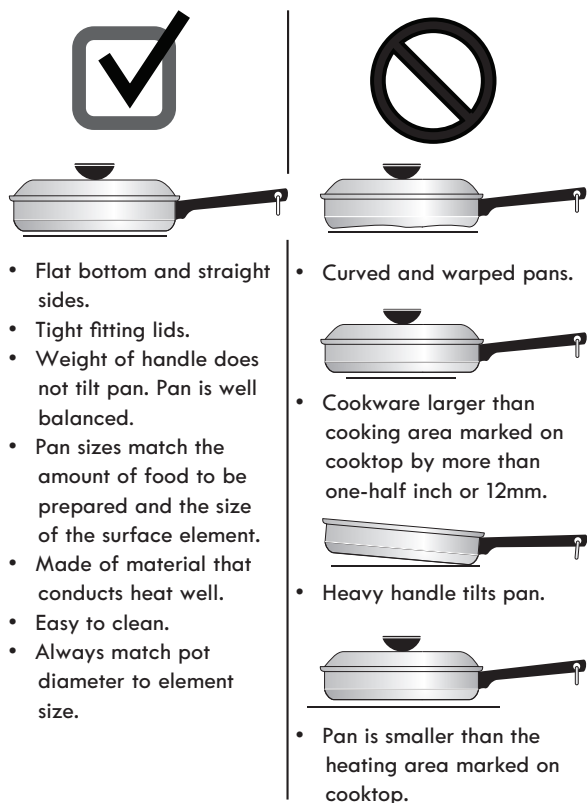

- Flat bottom and straight sides.
- Tight fitting lids.
- Weight of handle does not tilt pan. Pan is well balanced.
- Pan sizes match the amount of food to be prepared and the size of the surface element.
- Made of material that conducts heat well.
- Easy to clean.
- Always match pot diameter to element size.

- Curved and warped pans.
- Cookware larger than cooking area marked on cooktop by more than one-half inch or 12mm.
- Heavy handle tilts pan.
- Pan is smaller than the heating area marked on cooktop.

Cookware Material Types

The cookware material determines how evenly and quickly heat is transferred from the surface element to the pan bottom. The most popular materials available are:

Aluminum - Excellent heat conductor. Some types of food will cause it to darken (Anodized aluminum cookware resists staining and pitting). If aluminum pans slide across the ceramic cooktop, they may leave metal marks which will resemble scratches. Remove these marks immediately.

Copper - Excellent heat conductor but discolors easily (See Aluminum).

Stainless - Slow heat conductor with uneven cooking results. Is durable, easy to clean and resists staining.

Cast Iron - A slow heat conductor however will retain heat very well. Cooks evenly once cooking temperature is reached. Not recommended for use on ceramic cooktops.

Porcelain-enamel on metal - Heating characteristics will vary depending on base material. Porcelain-enamel coating must be smooth to avoid scratching ceramic cooktops.

Glass - Slow heat conductor. Not recommended for ceramic cooktop surfaces because it may scratch the glass.

➔ IMPORTANT

Do not place empty aluminum, glass or porcelain-enamel coated cookware on the ceramic cooktop! The melting point of cookware made with these materials may be reached quickly especially if left empty, and they may bond to the ceramic cooktop. If the cookware melts it will damage the cooktop! Be sure to follow all the cookware manufacturer's suggestions when using any type of cookware on the ceramic cooktop.

Figure 3: Proper cookware placement

BEFORE SETTING SURFACE CONTROLS

About Surface Elements

Your cooking product includes a new generation of electric coil element. This electric coil element design follows/ supports a change made to the UL Standard for Household Electric Ranges related to cooktop surface temperature detection. If ordering replacement electric coil elements, you must refer to the parts catalog to obtain the correct part number for the electric coil element that was designed to function with the specific model that was purchased.

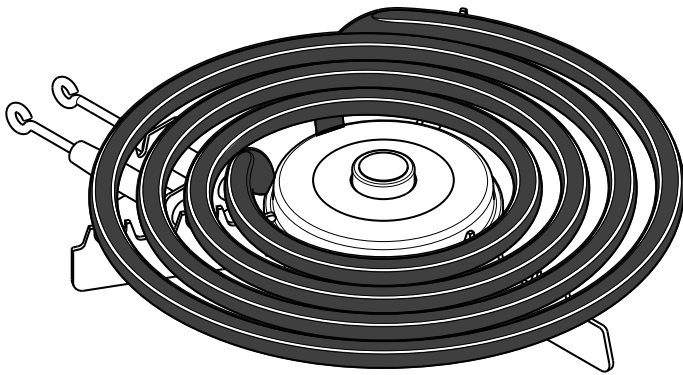

Figure 4: Coil element

! CAUTION

Never cover any slots, holes, or passages in the oven bottom or cover an entire oven rack with any materials, such as aluminum foil or aftermarket oven liners. Aluminum foil and other liners may trap heat, causing a fire hazard.

For efficient cooking, turn off the element several minutes before cooking is complete. This will allow residual heat to complete the cooking process.

The type and size of cookware, the number of surface elements in use and their settings are all factors that will affect the amount of heat that will spread to areas beyond the surface elements. The areas surrounding the elements may become hot enough to cause burns.

Hot Surface Indicator Light

Your appliance is equipped with a radiant surface control indicator light, which is located on the control panel (Figure 5).

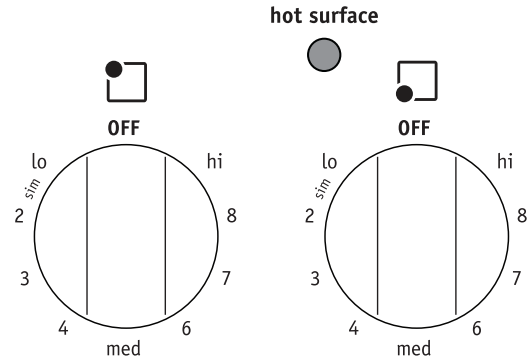

Figure 5: Hot surface indicator light location

The hot surface indicator light will glow when any surface cooking area heats up and will remain on until the cooktop has cooled to a moderate level.

! CAUTION

The surface may still be hot and burns may occur if the surface is touched before the indicator light has turned off.

BEFORE SETTING SURFACE CONTROLS

Home Canning

CAUTION

Canning can generate large amounts of steam. Use extreme caution to prevent burns. Always raise the lid to vent steam away from you. Safe canning requires that harmful micro-organisms are destroyed and the jars are sealed completely. When canning in a water bath canner, a gentle but steady boil must be maintained continuously for the required time.

Be sure to read and observe all the following points when home canning with your appliance. Check with the USDA (United States Department of Agriculture) Web site and be sure to read all the information they have available as well as follow their recommendations for home canning procedures.

- Use only quality flat bottom canners when home canning. Use a straight-edge to check canner bottom.
- Use only a completely flat bottom canner with no ridges that radiate from the bottom center when home canning. Heat is spread more evenly when the bottom surface is flat.
- Make sure the diameter of the canner does not exceed 1 inch beyond the surface element markings or burner. It is recommended to use smaller diameter canners on electric coil and ceramic glass cooktops and to center canners on the burner grates.
- Start with hot tap water to bring water to boil more quickly.
- Use the highest heat setting when first bringing the water to a boil. Once boiling is achieved, reduce heat to lowest possible setting to maintain that boil.
- Use tested recipes and follow instructions carefully. Check with your local Cooperative Agricultural Extension Service or a manufacturer of glass jars for the latest canning information.
- It is best to can small amounts and light loads.
- Do not leave water bath or pressure canners on high heat for an extended amount of time.
- Alternate surface units between each batch to allow the units and surrounding surfaces to cool down. Try to avoid canning on the same burner unit all day.

SETTING SURFACE CONTROLS

Surface Cooking Elements and Settings

The cooktop has four single coil surface elements, depending upon your appliance.

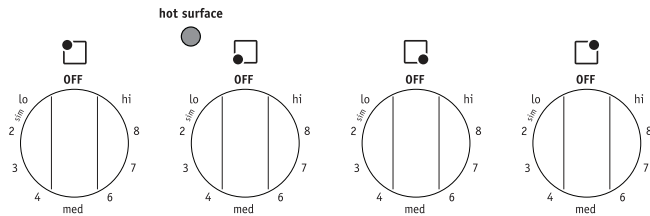

Figure 6: Surface control knobs

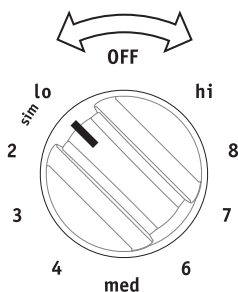

Figure 7: Control knob shown is typical only

The size and type of utensil used, and the amount and type of food being cooked will influence the surface element power level setting needed for best cooking results. Use [Table 1](#) to determine the correct setting for the type of food you are preparing.

Table 1: Recommended settings for surface elements

Setting	Type of Cooking
HIGH (HI)	Start most foods; bring water to a boil and pan broiling.
MEDIUM HIGH (8-10)	Continue a rapid boil; frying, deep fat frying
MEDIUM (6)	Maintain a slow boil; thicken sauces and gravies; steaming vegetables
Medium LOW (2-4)	Keep foods cooking; poaching and stewing
LOW (LO)	Keep warm, melting and simmering

To Operate the Surface Elements:

CAUTION

Radiant surface elements may appear to have cooled after they have been turned off. The indicator light will turn on and will continue to glow until the cooktop has cooled down to a moderate level. The surface may still be hot and burns may occur if the surface is touched before the indicator light has turned off.

CAUTION

Do not allow aluminum foil, empty glass/porcelain cookware or any material that can melt to make contact with the cooktop. If these items melt on the cooktop they may damage the cooktop.

CAUTION

Do not place plastic items such as salt and pepper shakers, spoon holders or plastic wrappings on top of the range when it is in use. These items could melt or ignite. Potholders, towels or wooden spoons could catch fire if placed too close to the surface elements.

1. Place correctly sized cookware on the coil surface element.
2. Push in and turn the surface control knob in either direction to the desired setting ([Figure 7](#)). Start most cooking operations on a higher setting and then turn to a lower setting to finish cooking. Each surface element provides a constant amount of heat at each setting. A glowing red surface heating area extending beyond the bottom edge of the cookware indicates the cookware is too small for the surface heating area.
3. When cooking has completed, turn the surface control knob to OFF before removing the cookware.

Surface Cooking Tips:

- For efficient cooking, turn off the element several minutes before cooking is complete. This will allow residual heat to complete the cooking process.
- The surface Element On indicator lights will glow when one or more elements are turned on. A quick glance at these indicator lights when cooking is finished is an easy check to be sure all surface elements are turned off.

BEFORE SETTING OVEN CONTROLS

Oven Vent Location

The oven vent is located under the control panel. When the oven is on, warm air passes through this vent. This venting is necessary for proper air circulation in the oven and good baking results. Do not block oven vent. Never close off the openings with aluminum foil or any other material. Steam or moisture may appear near the oven vent. This is normal.

The Cooling Fan

The cooling fan operates during cooking. Air is expelled through the vents between the oven door and the control panel, as shown in [Figure 8](#).

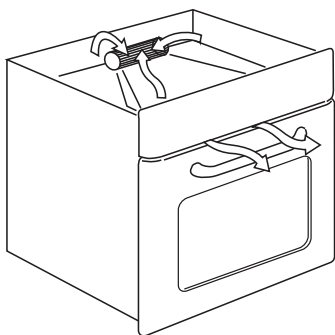

Figure 8: Oven vent location

Removing, Replacing, and Arranging Racks

This appliance comes with two flat racks.

CAUTION

Always use pot holders or oven mitts when using the oven. When cooking, the oven interior and exterior, oven racks, and cooktop will become very hot which can cause burns.

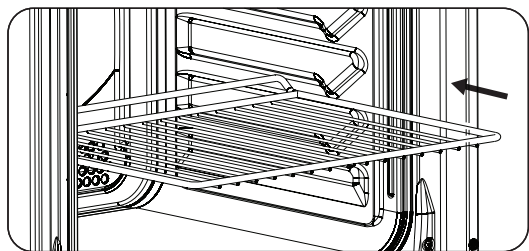

Figure 9: Removing, replacing, and arranging racks

WARNING

Protective Liners — Do not use aluminum foil to line the oven bottom. Only use aluminum foil as recommended in this manual. Improper installation of these liners may result in risk of electric shock or fire.

To arrange - Always arrange the oven racks when the oven is cool (prior to operating the oven).

To remove - Pull the oven rack straight forward until it reaches the stop position. Lift up front of oven rack slightly and slide out.

To replace - Place the oven rack on the rack guides on both sides of oven walls. Tilt the front of oven rack upward slightly and slide the oven rack back into place. Be sure oven racks are level before using.

Flat Oven Rack

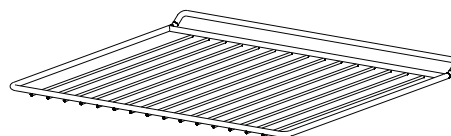

Figure 10: Flat oven rack

Air Circulation in the Oven

The rack has a special shape in the rear which helps with the heat circulation.

Do not push the baking tray all the way to the back wall of the cavity. This prevents the heat from circulating around the tray. The food may be burnt, especially in the rear part of the tray.

For best air circulation when baking, allow a space of 2 inches (5 cm) around the cookware for proper air circulation. Be sure pans and cookware do not touch each other, the oven door, sides, or back of the oven cavity.

Hot air must be able to circulate around cookware for even heat to reach the food.

SETTING OVEN CONTROLS

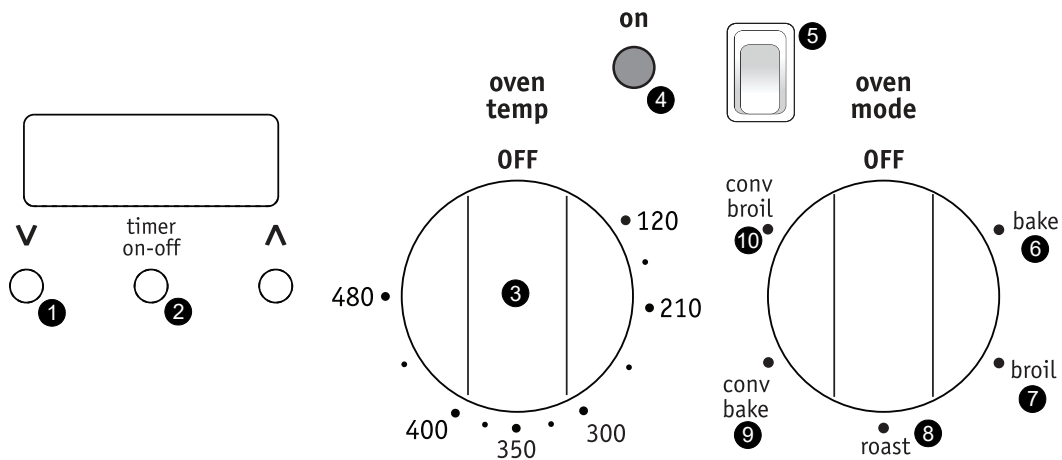

Oven Control Features

- Up / Down arrows** - Use to adjust and set the appliance's timer functionality.
- Timer on-off** - Use to set or cancel the minute timer. The minute timer does not start or stop any cooking function.
- Oven temp knob** - Use to select the desired cooking temperature.
- Oven indicator light** - Glows each time the oven cycles on to maintain the set oven temperature.
- Oven light** - Use this switch to turn the internal oven light on or off.
- Bake** - Use to enter the normal baking mode temperature and start a normal baking function.
- Broil** - Use to set the broil function.
- Roast** - Use to select the roasting function, best for cooking tender cuts of beef, lamb, pork, and poultry.
- Conv bake** - Use to select convection baking, which is used to obtain the best culinary results when baking with multiple pans and racks at any temperature.
- Conv broil** - Use to select the convection broil function, best for thicker cuts of meat, fish and poultry. Convection broiling gently browns the exterior and seals in the juices.

Operating the Oven Light

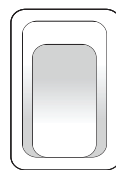

Press the oven light switch located on the control panel to turn the interior oven light on and off. The light is located in the rear of the oven interior. To replace the interior oven light, see "" on [page 30](#).

Figure 11: Oven light switch

Setting the Time

You must set the time before you operate the oven. When you connect the appliance to the electrical supply or after a power outage, the display flashes automatically.

To set the time:

- Press **timer on-off**. The timer activate symbol will come on.
- Use **^** and **V** to set the correct time of day. After approximately five seconds, the flashing stops and the display shows the time of day you set.

To change the time:

- When the appliance is active, press and hold **^** and **V** at the same time.
- When the dot between the hour and minutes flashes, use **^** and **V** to set the new time.

NOTE

On some models, the time of day is a 24-hour clock and cannot be changed to 12 hours.

SETTING OVEN CONTROLS

Timer Functions

This appliance is equipped with three timer options: minute countdown timer, cook time (**dur**), and end time (**END**).

Table 2: Timer Functions

Function	Application
Minute Timer ()	Use to track your cooking times without interfering with the cooking process. The timer may be set from a minimum time of 1 minute to a maximum of 23 hours and 59 minutes.
Cook Time Duration (dur)	Use to set the cooking time of the oven, from 1 minute to 10 hours.
End Time (END)	Use to program the oven when to stop cooking, from 1 minute to 10 hours.

Display Indicators

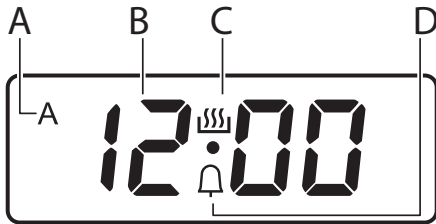



Figure 12: Clock display functions

- **A:** Duration and End time indicator
- **B:** Time display
- **C:** Timer active indicator
- **D:** Minute timer indicator

To set a timer function:

1. For Duration (**dur**) and **END** (**end**), use the **oven temp** and **oven mode** knobs to set an oven function and cooking temperature. (This is not necessary for .)
2. Press **timer on-off** until the desired function option appears, indicated by the bell symbol, **dur**, or **END**, and starts to flash.
3. Press **▲** or **▼** to set the desired timer function. The timer function activates, and the corresponding indicator will appear in the display. For **End** and **dur**, **A** will also appear in the display.

NOTE

Duration and End time may be used at the same time if you want the appliance to activate and deactivate automatically. First, set Duration. Then, set End.

4. When the time ends, the function's indicator on the display will start flashing and an signal will sound for two minutes. Press any button to stop the signal.

IMPORTANT

With the Duration and End functions, the appliance will stop cooking automatically.

To cancel the timer function:

1. Press **timer on-off** until the desired function option appears.
2. Press and hold **▲** and **▼** at the same time. The timer function will go out after several seconds.

To change the acoustic signal:

1. To hear the current signal, press and hold **▼**.
2. Repeatedly press **▼** to change the signal.
3. Release **▼**. The last tone you heard will be the new signal.
4. Wait five seconds for the setting to be confirmed.

NOTE

When the appliance is disconnected from the outlet or after a power outage, the signal tone will be set back to the default tone.

SETTING OVEN CONTROLS

Setting Bake

Use the bake feature whenever the recipe calls for baking using normal temperatures.

To set bake:

CAUTION

Always use pot holders or oven mitts when using the oven. When cooking the oven interior, oven racks, and cooktop will become very hot which can cause burns.

CAUTION

Do not bake foods directly on the oven bottom. To avoid damaging the oven interior and surfaces, always bake foods in the oven using bakeware positioned on an oven rack.

1. Arrange oven racks while the oven is still cool.
2. Allow oven to preheat for 8-to-10 minutes before baking. Preheating is not necessary when roasting, cooking casseroles, or broiling most foods.
3. Turn the **oven mode** knob to the **bake** position (Figure 13).

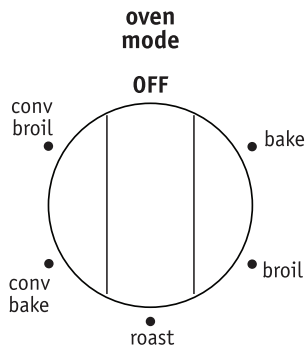

Figure 13: Oven mode knob

4. Turn the **oven temp** knob to the desired temperature position (Figure 14).

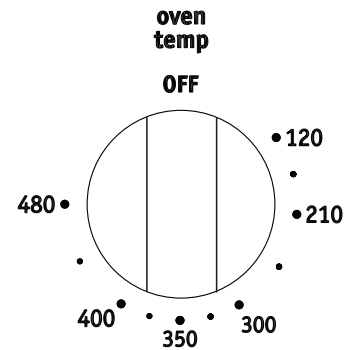

Figure 14: Oven temp knob

WARNING

Incorrect operation of the appliance or defective components can cause dangerous overheating. To prevent this, this appliance has a safety thermostat which interrupts the power supply. The appliance activates again automatically when the temperature drops.

5. To cancel the baking function, turn the **oven mode** and **oven temp** knobs to the **OFF** positions.

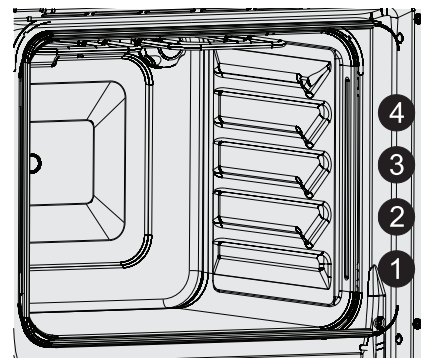

Figure 15: Oven rack positions

SETTING OVEN CONTROLS

Single Rack Baking

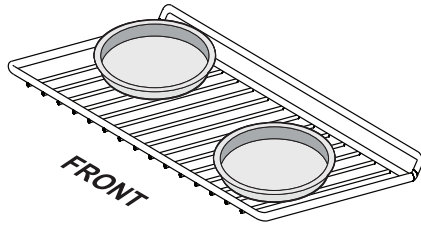

Figure 16: Baking with a single rack

If you choose to use a single rack while cooking, then radiant baking is preferred.

→ IMPORTANT

For this appliance, single rack radiant bake is the recommended bake function for best results for batter and dough-based baked goods such as cakes, pastries, and breads.

- For best results when baking with one oven rack, place racks in positions 2 or 3 (Figure 15).
- When baking using one oven racks, position bakeware as shown in Figure 16. Allow at least 2 inches (5 cm) of space between bakeware for proper air circulation.

📌 NOTE

The single rack baking image is correct, but it's also for presentation purposes. You may also bake with the left pan in the front and the right pan in the back. Either position for either pan bakes correctly.

Multi-Rack Baking

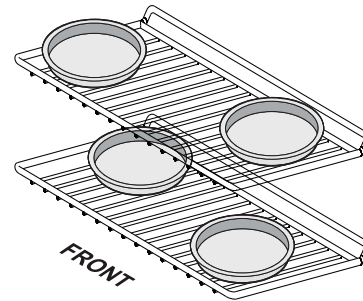

Figure 17: Baking with multiple levels & racks

If you choose to use multiple rack while cooking, then Convection baking is preferred.

- For best results when baking cakes or cookies using two oven racks, place racks in positions 1 and 3 (Figure 15) and place pans as shown in Figure 17.
- Allow at least 2 inches (5 cm) of space between bakeware for proper air circulation.

→ IMPORTANT

When baking using two oven racks, the pans on each rack must be swapped half way through the cook time for best results.

General Baking Tips:

- Preheat the oven 8-10 minutes before baking items like cookies, biscuits, cakes, and breads.
- Dark or dull pans absorb more heat than shiny bakeware, resulting in dark or over browning of foods. It may be necessary to reduce the oven temperature or cook time to prevent over browning of some foods. Dark pans are recommended for pies. Shiny pans are recommended for cakes, cookies, and muffins.
- Do not open the oven door too often. Opening the door will reduce the temperature in the oven.
- Glass bakeware is a slow heat conductor. May require reducing oven temperature.

SETTING OVEN CONTROLS

Setting Broil

Use to cook meats that require direct exposure to radiant heat for optimum browning results. Position the rack as suggested in [Table 3](#).

NOTE

Keep the oven door closed when broiling. The escaping heat could damage appliance knobs and controls.

To set broil

1. Arrange the oven rack while oven is still cool. Turn the **oven mode** knob to the **broil** position ([Figure 13](#)).
2. Turn the **oven temp** knob to the desired temperature position ([Figure 14](#)). For optimum results, preheat broil for 2-to-5 minutes before adding food.
3. Place the insert on the broil pan (if equipped), then place the food on the broil pan insert (if using a broiler pan and insert). To purchase a broiling pan and insert, visit frigidaire.com
4. Place the broiler pan and insert on the oven rack. Center the broiler pan directly under the broiler element. Broil on one side until food is browned. Always pull the oven rack out to the stop position before turning or removing food. Turn and broil food on the second side.
5. To cancel the broiling function, turn the **oven mode** and **oven temp** knobs to the **OFF** positions.

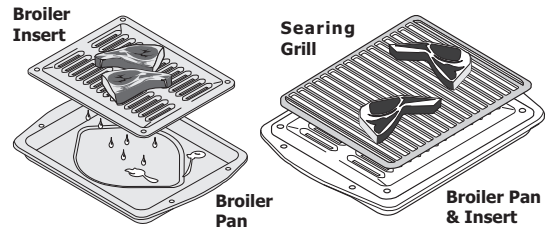

Figure 18: Broil accessories

WARNING

Should an oven fire occur, keep oven door closed and turn off the oven. If the fire continues, throw baking soda on the fire or use a fire extinguisher. Do not put water or flour on the fire. Flour may be explosive and water can cause a grease fire to spread and cause personal injury.

The broiler pan and the insert allow grease to drain and be kept away from the high heat of the broiler. Do not use the pan without the insert. Do not cover the insert with aluminum foil; the exposed grease could ignite.

CAUTION

Always use pot holders or oven mitts when using the oven. When cooking, the oven interior, oven racks, and cooktop will become very hot which can cause burns.

Table 3: Broil recommendations^a

Food item	Rack Position	Temperature	Cook time in minutes		Doneness
			1st side	2nd side	
Steak 1" thick	3rd	480°F	7:00	6:00	Rare
	4th	480°F	8:00	7:00	Medium
Pork Chops 3/4 "thick	3rd or 4th	480°F	8:00	6:00	Well
Chicken - Bone In	3rd	450°F	20:00	10:00	Well
Chicken Boneless	3rd or 4th	450°F	8:00	6:00	Well
Fish	3rd	480°F	13:00	--	Well
Shrimp	3rd	480°F	5:00	--	Well
Hamburger 1" thick	3rd	480°F	7:00	6:00	Rare
	3rd or 4th	480°F	9:00	7:00	Medium

a. The U.S. Department of Agriculture states, "Rare fresh beef is popular, but you should know that cooking it to only 140°F (60°C) means some food poisoning organisms may survive." (Source: Safe Food Book, Your Kitchen Guide, USDA Rev. June 1985.) The lowest temperature recommended by the USDA is 145°F (63°C) for medium rare fresh beef. For beef medium 160°F, well done 170°F.

SETTING OVEN CONTROLS

Setting Convection Bake

Convection functions use a fan to circulate the oven's heat uniformly and continuously around the oven (Figure 19). This improved heat distribution allows for fast, even baking and browning results. It also gives better baking results when using two oven racks at the same time. Heated air flows around the food from all sides, sealing in juices and flavors. Breads and pastry brown more evenly. Most foods baked in a standard pan will bake faster and more evenly with the convection feature. Multiple rack baking may slightly increase bake time for some foods, but the overall result is time saved.

Benefits of Convection Bake:

- Superior multiple oven rack performance
- Foods bake more evenly
- Foods can bake up to 25 to 30% faster.

IMPORTANT

When using convection bake, decrease your normal cooking times. Adjust the cook time for desired doneness as needed. Time reductions will vary depending on the amount and type of food to be cooked.

CAUTION

Be aware that the convection fan will continue to run after the door is opened. This is normal. Use caution when reaching inside of the oven. Hot air will be pushed out of the appliance.

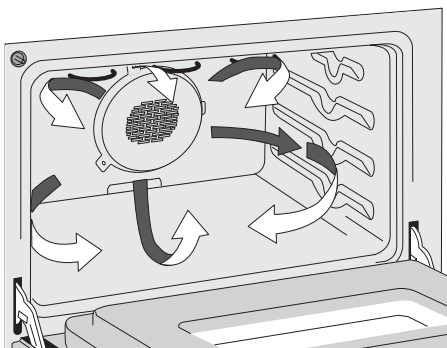

Figure 19: Air movement using convection

To set convection bake:

CAUTION

Always use pot holders or oven mitts when using the oven. When cooking the oven interior, oven racks, and cooktop will become very hot which can cause burns.

CAUTION

Do not bake foods directly on the oven bottom. To avoid damaging the oven interior and surfaces, always bake foods in the oven using bakeware positioned on an oven rack.

1. Arrange oven racks while the oven is still cool.
2. Allow oven to preheat the oven for 8-to-10 minutes before baking. Preheating is not necessary when roasting, cooking casseroles, or broiling most foods.
3. Turn the **oven mode** knob to the **conv bake** position (Figure 20).

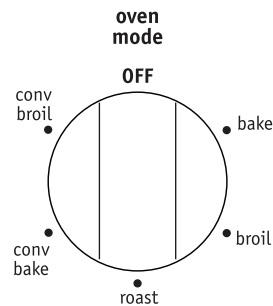

Figure 20: Oven mode knob

4. Turn the **oven temp** knob to the desired temperature position (Figure 21).

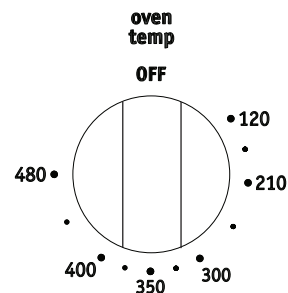

Figure 21: Oven temp knob

SETTING OVEN CONTROLS

WARNING

Incorrect operation of the appliance or defective components can cause dangerous overheating. To prevent this, this appliance has a safety thermostat which interrupts the power supply. The appliance must be manually activated after the temperature drop, restoring the timer.

- To cancel the baking function, turn the **oven mode** and **oven temp** knobs to the **OFF** positions.

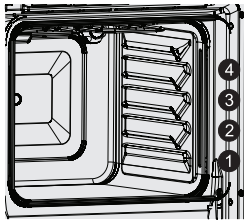

Figure 22: Oven rack positions

Single Rack Baking

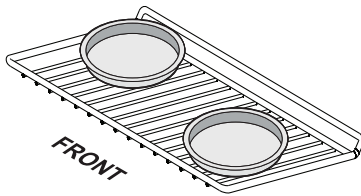

Figure 23: Baking with a single rack

IMPORTANT

For this appliance, single rack radiant bake is the recommended bake function for best results for batter and dough-based baked goods such as cakes, pastries, and breads.

- For best results when baking with one oven rack, place racks in positions 2 or 3 (Figure 22).
- When baking using one oven rack, position bakeware as shown in Figure 23. Allow at least 2 inches (5 cm) of space between bakeware for proper air circulation.
- The single rack baking image is correct, but it's also for presentation purposes. You may also bake with the left pan in the front and the right pan in the back. Either position for either pan bakes correctly.
- If you choose to use a single rack while cooking, then radiant baking is preferred. If you choose to use multiple rack while cooking, then Convection baking is preferred.

Multi-Rack Baking

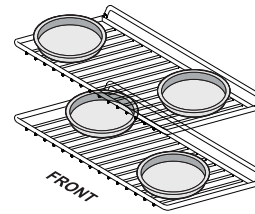

Figure 24: Baking with multiple levels & racks

If you choose to use multiple rack while cooking, then Convection baking is preferred.

- For best results when baking cakes or cookies using two oven racks, place racks in positions 1 and 3 (Figure 22) and place pans as shown in Figure 24.
- Allow at least 2 inches (5 cm) of space between bakeware for proper air circulation.

IMPORTANT

When baking using two oven racks, the pans on each rack must be swapped half way through the cook time for best results. The top rack should go on the bottom rack and the bottom to the top.

General Baking Tips:

- When using convection, use bakeware with low sides. This allows the air to circulate around the food evenly.
- Because most food items will cook faster and more evenly with the convection feature, it is advisable to reduce recipe's recommended temperature by 25° for best results. Follow the recipe's instructions using the minimum recommended cook time.
- When using Conv Bake, cook time reductions may vary depending on the amount and type of food being cooked.
- Fully preheat the oven for 8-10 minutes before baking items like cookies, biscuits and breads.
- Dark or dull pans absorb more heat than shiny bakeware, resulting in dark or over browning of foods. It may be necessary to reduce the oven temperature or cook time to prevent over browning of some foods. Dark pans are recommended for pies. Shiny pans are recommended for cakes, cookies, and muffins.
- Do not open the oven door too often. Opening the door will reduce the temperature in the oven.
- Glass bakeware is a slow heat conductor. May require reducing oven temperature.

SETTING OVEN CONTROLS

Setting Roast

Use the roast function to roast meats and poultry. Meats cooked using the roast function will be juicier and poultry will be crisp on the outside while staying tender and moist on the inside.

Suggestions for roast:

- The broiler pan will catch grease drippings, and the grid will help prevent splatters. The roasting rack will hold the meat.
- Do not cover foods when dry roasting as this will prevent the meat from browning properly.
- It is not recommended to roast chicken on a roasting rack. Use a deep pan instead.
- Use a deep pan for fatty food to prevent the oven from stains that can be permanent.

To set roast:

CAUTION

Always use pot holders or oven mitts when using the oven. When cooking the oven interior, oven racks, and cooktop will become very hot which can cause burns.

CAUTION

Do not bake foods directly on the oven bottom. To avoid damaging the oven interior and surfaces, always bake foods in the oven using bakeware positioned on an oven rack.

1. Arrange oven racks while the oven is still cool.
2. Preheat the oven if desired, but preheating is not necessary when roasting and cooking casseroles. Preheating is necessary when broiling.

3. Turn the **oven mode** knob to the **roast** position (Figure 25).

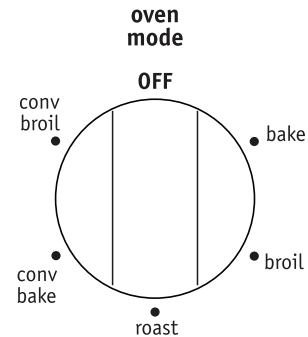

Figure 25: Oven mode knob

4. Turn the **oven temp** knob to the desired temperature setting (Figure 26).

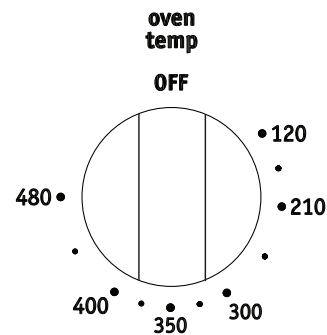

Figure 26: Oven temp knob

WARNING

Incorrect operation of the appliance or defective components can cause dangerous overheating. To prevent this, this appliance has a safety thermostat which interrupts the power supply. The appliance must be manually activated after the temperature drop, restoring the timer.

5. To cancel the roasting function, turn the **oven mode** and **oven temp** knobs to the **OFF** positions.

SETTING OVEN CONTROLS

Setting Convection Broil

Use convection broil to cook thicker cuts of meat, fish, and poultry that require direct exposure to radiant heat and the convection fan for optimum browning results. Convection broil gently browns the exterior and seals in the juices. It uses the broil element and a fan to circulate the oven's heat evenly and continuously within the oven.

The convection fan will begin rotating once convection broil has been activated.

Convection Broiling Tips:

- Always pull the rack out to the stop position before turning or removing food.
- Always broil or convection broil with the oven door closed.
- For optimum results, preheat the broil element for 2-to-5 minutes before adding food.
- Broil one side until the food is browned; turn and cook on the second side. Season and serve.
- Always use the broiler pan and its insert when broiling, if included. It allows the dripping grease to be kept away from the high heat of the broil element.
- Do not use the broil pan without the insert. Do not cover the broil pan insert with foil. The exposed grease could catch fire. Do not use the roasting rack when broiling.
- Since convection broil cooks food quickly, reduce the cook time by 25% from the recommended cook time of your recipe (check the food at this time). If necessary, increase cook time until the desired doneness is obtained.

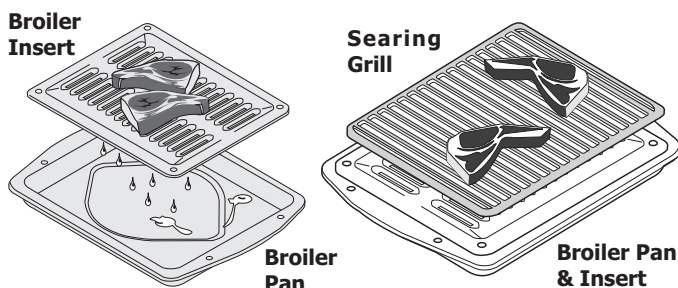

Figure 27: Broil accessories

To set convection broil

! WARNING

Should an oven fire occur, keep oven door closed and turn off the oven. If the fire continues, throw baking soda on the fire or use a fire extinguisher. Do not put water or flour on the fire. Flour may be explosive and water can cause a grease fire to spread and cause personal injury.

The broiler pan and the insert allow grease to drain and be kept away from the high heat of the broiler. Do not use the pan without the insert. Do not cover the insert with aluminum foil; the exposed grease could ignite.

! CAUTION

Always use pot holders or oven mitts when using the oven. When cooking, the oven interior, oven racks, and cooktop will become very hot which can cause burns.

1. Arrange the oven rack while oven is still cool. Turn the **oven mode** knob to the **conv broil** position.
2. Turn the **oven temp** knob to the desired temperature position. For optimum results, preheat broil for 2-to-5 minutes before adding food.
3. Place the insert on the broil pan (if equipped), then place the food on the broil pan insert (if using a broiler pan and insert). To purchase a broiling pan and insert, visit frigidaire.com
4. Place the broiler pan and insert on the oven rack. Center the broiler pan directly under the broiler element. Broil on one side until food is browned.

! NOTE

Always pull the oven rack out to the stop position before turning or removing food.

5. Turn and broil food on the second side.
6. To cancel the broiling function, turn the **oven mode** and **oven temp** knobs to the **OFF** positions.

CARE AND CLEANING

Cleaning Various Parts of Your Appliance

Before cleaning any part of the appliance, be sure all controls are turned off and the cooktop and oven are cool. Remove spills and any heavy soiling as soon as possible. Regular cleaning will reduce the difficulty and time of major cleaning.

Surface Type	Recommendation
Aluminum and Vinyl	Use hot, soapy water and a cloth. Dry with a clean cloth.
Painted and plastic control knobs Painted body parts Painted decorative trims	Using a soft cloth and clean with mild dish detergent and water or a 50/50 solution of vinegar and water. Follow by rinsing the area with clean water; dry and polish with a soft cloth. Glass cleaners may be used if sprayed on a soft cloth first. Do not spray liquids directly on the oven control and display area. Do not use large amounts of water on the control panel - excess water on the control area may cause damage to the appliance. Do not use other liquid cleaners, abrasive cleaners, scouring pads, or paper towels - they will damage the finish. To remove control knobs, turn to the OFF position; grasp firmly and pull straight off the shaft. To replace knobs after cleaning, line up the flat sides of both the knob and the shaft; then push the knob into place.
Stainless Steel	Your appliance's finish may be made with stainless steel (some models). Clean the stainless with warm soapy water using a clean sponge or cloth. Rinse with clean water and dry with a soft clean cloth. Do not use any store bought cleaners like stainless steel cleaners or any other types of cleaners containing any abrasive, chlorides, chlorine or ammonia. It is recommended to use mild dish soap and water or a 50/50 solution of water and vinegar.
Cooktop	Do not use spray oven cleaners on the cooktop.
Porcelain enamel broiler pan and insert (available by mail order) Door liner and body parts	Gentle scouring with a soapy scouring pad will remove most spots. Rinse with a 1:1 solution of clear water and ammonia. If necessary, cover difficult spots with an ammonia-soaked paper towel for 30 to 40 minutes. Rinse with clean water and a damp cloth, and then scrub with a soap-filled scouring pad. Rinse and wipe dry with a clean cloth. Remove all cleaners or the porcelain may become damaged during future heating.
Oven racks	Oven racks must be removed from oven cavity. Clean by using a mild, abrasive cleaner following manufacturer's instructions. Rinse with clean water and dry.
Oven door	Use soap and water to thoroughly clean the top, sides, and front of the oven door. Rinse well. You may use a glass cleaner on the outside glass of the door. Do not immerse the door in water. Do not spray or allow water or the glass cleaner to enter the door vents. Do not use oven cleaners, cleaning powders, or any harsh abrasive cleaning materials on the outside of the oven door. Do not clean the oven door gasket. Care should be taken not to rub, damage, or remove this gasket.
Oven interior	For oven interior remove excessive spillovers from oven cavity bottom. Clean any soils from oven frame and door liner outside the oven door gasket,

CARE AND CLEANING

Control panel
Control keypad membrane
Decorative trim (some models)

Before cleaning the control panel, turn all controls off, activate oven lockout (on some models), and if needed remove any knobs from panel. Do not use abrasive cleaners on any of these materials; they can scratch. Clean using hot, soapy water and a cloth or sponge. Be sure to squeeze excess water from cloth or sponge before wiping control panel, especially when wiping around the controls area. Excess water in or around the controls may cause damage to the appliance. When rinsing, use clean water and a cloth or sponge and be sure to squeeze excess water from cloth or sponge before wiping the control panel.

CARE AND CLEANING

Coil Cooktop Surface Elements and Drip Bowls Cleaning

Surface elements may be unplugged and removed to make cleaning the drip pans easier. The surface elements clean themselves when they are turned on. Food spilled on a hot element will burn off. Food spilled on a cool element may be cleaned with a damp cloth. Any remaining soil will burn off the next time the element is used.

To remove the surface elements and drip bowls:

CAUTION

Surface elements may appear to have cooled after they have been turned off. The surface elements may still be hot and burns may occur if touched before they have cooled sufficiently.

CAUTION

Protective liners — Do not use aluminum foil to line surface drip bowls or reflector pans. Only use aluminum foil as recommended in this manual. Improper installation of these liners may result in risk of electric shock or fire.

1. Lift the edge of the drip bowl across from the terminal end. Lift the surface element and drip bowl together just enough to clear the cooktop.
2. While holding the drip bowl and surface element, gently pull the terminal end out from terminal plug (Figure 28).

Note: Do not remove the Hold Down Clip (if equipped) from the drip bowl.

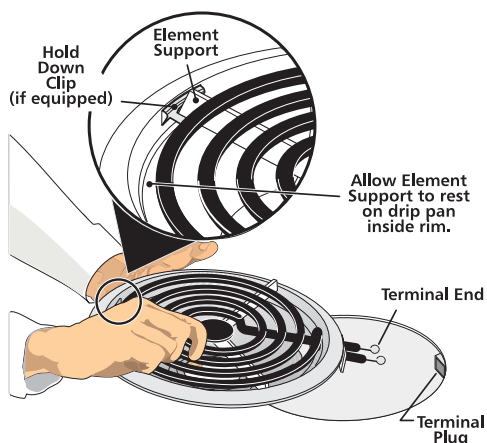

Figure 28: Removing surface elements and drip bowls

Cleaning Drip Bowls

Wash in hot, soapy water or in the dishwasher. Rinse and dry while still warm. Hard to remove, burned on soil can be removed by soaking the drip bowls for about 20 minutes in a lightly diluted liquid cleanser or a solution of ammonia and water (1/2 cup ammonia to 1 gallon of water). A non-abrasive scouring pad may be used after soaking. Do not use abrasive cleaners or steel wool. They will scratch the surface. Always rinse with clean water and polish dry with a soft cloth.

To replace drip bowls and surface elements:

1. Slide the terminal end on the surface element through the opening in the drip bowl (Figure 28).
 2. Align the surface element support to rest on the rim inside the drip bowl.
- Note:** At this time in the procedures, if your drip bowl is equipped with a Hold Down Clip, align the element support opposite the terminal end with the slot in the Hold Down Clip, and snap into place.
3. After the surface element is positioned in the drip bowl, line up the terminal end with the terminal plug as shown (Figure 28).
 4. Hold the surface element and drip bowl together as level as possible and firmly push the terminal end into the terminal plug. Make sure element terminal is seated properly into terminal plug. Make sure the surface element is level to reduce the hazard of cookware sliding off the element.

Important: Be sure the range is cool before removing surface elements or drip bowls. Never immerse a surface element in water. Make sure drip bowls are in place - Absence of these bowls during cooking may subject wiring or components underneath to damage. Be careful not to bend terminal ends when replacing surface elements after cleaning.

CARE AND CLEANING

General Cleaning

Refer to “Cleaning Various Parts of Your Appliance” on page 25 for more detailed information about cleaning specific parts of the range.

CAUTION

Before manually cleaning any part of the range, be sure all controls are turned off and the range is cool. The range may be hot and can cause burns.

CAUTION

Ammonia must be rinsed before operating the oven. Provide adequate ventilation.

Aluminum Foil and Utensils

WARNING

Never cover any slots, holes, or passages in the oven bottom or cover an entire oven rack with materials such as aluminum foil. Aluminum foil linings may trap heat, causing a fire hazard.

WARNING

Protective Liners — Do not use aluminum foil to line the oven bottom. Only use aluminum foil as recommended in this manual. Improper installation of these liners may result in risk of electric shock, or fire.

- Aluminum foil - Use of aluminum foil on a hot cooktop can damage the cooktop. Do not use thin aluminum cooking utensils or allow aluminum foil to touch the surface elements under any circumstances.
- Aluminum utensils - The melting point of aluminum is much lower than that of other metals. Care must be taken when aluminum pots or pans are used on the cooktop. If aluminum pans are allowed to boil dry when using the cooktop, not only will the utensil be damaged or destroyed, but it may fuse to, break, or mark the ceramic glass surface, permanently damaging the cooktop surface.

Replacing the Oven Light

Replacing the oven interior light bulb:

CAUTION

Be sure the oven is unplugged and all parts are cool before replacing oven light.

The interior oven light is located at the rear of the oven cavity. The glass cover must be in place whenever the oven is in use (Figure 29). Only use lamps with the same specifications.

1. Put a cloth on the bottom of the interior of the appliance. It prevents damage to the lamp glass cover and the cavity.
2. Turn electrical power off at the main source or unplug the appliance.
3. Turn the lamp glass cover counterclockwise to remove it.
4. Clean the glass cover.
5. Replace the lamp with a suitable 300°C heat-resistant lamp.

NOTE

Do not allow your fingers to touch the new bulb when replacing. This will shorten the life of the bulb. Use a paper towel or cotton glove while handling the new bulb when installing.

6. Replace glass oven lamp glass cover.
7. Turn power back on again at the main source (or plug the appliance back in).

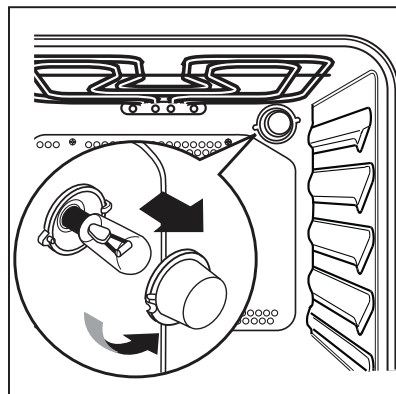

Figure 29: Oven light

Removing and Replacing the Oven Door

The oven door has three glass panels. You can remove the oven door to clean it.

To remove the oven door:

⚠ CAUTION

The door is heavy. For safe, temporary storage, lay the door flat with the inside of the door facing down. Do not use the appliance without the internal glass panel.

1. Open the door fully, horizontal with the floor, and hold the two door hinges (Figure 30).
2. Lift and turn/pull the levers on both of the door hinge locks down from the oven frame completely towards the oven door (Figure 31). A tool such as a small flat-blade screwdriver may be required.
3. Firmly grasp both sides of oven door along the door sides. Do not use the oven door handle. Close the oven door halfway to the first opening position. Then, pull forward and remove the door from its seat (Figure 32).
4. Put the door on a soft cloth on a stable surface (Figure 33).
5. Clean the glass panel with water and soap. Dry the glass panel carefully.

➔ IMPORTANT

Clean the oven door with a wet sponge only. Dry it with a soft cloth. Do not use steel wool, acids or abrasive materials as they can damage the oven surface. Clean the oven control panel with the same precautions.

➔ IMPORTANT

Special door care instructions - Most oven doors contain glass that can break. Do not close the oven door until all the oven racks are fully in place. Do not hit the glass with pots, pans, or any other object. Scratching, hitting, jarring, or stressing the glass may weaken its structure causing an increased risk of breakage at a later time.

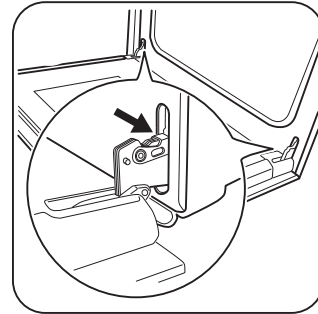

Figure 30: Door hinge locations

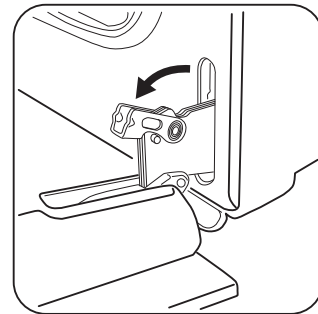

Figure 31: Door hinge locks

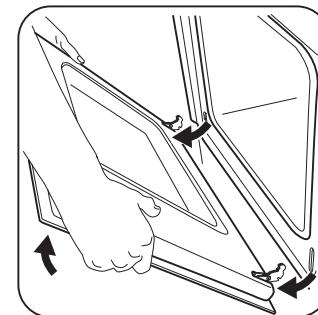

Figure 32: Holding door for removal

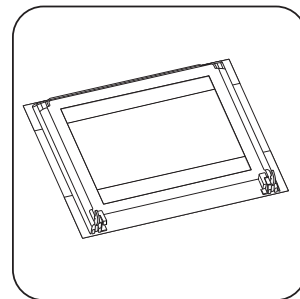

Figure 33: Place door on soft surface

CARE AND CLEANING

To replace the oven door:

IMPORTANT





Special door care instructions - Most oven doors contain glass that can break. Do not close the oven door until all the oven racks are fully in place. Do not hit the glass with pots, pans, or any other object. Scratching, hitting, jarring, or stressing the glass may weaken its structure causing an increased risk of breakage at a later time.

1. Firmly grasp both sides of oven door along the door sides. Do not use the oven door handle (Figure 32).
2. Holding the oven door at the same angle as the removal position, seat the hook of the hinge arm over the roller pins located on each side of the oven door frame (Figure 32). The hook of the hinge arms must be fully seated onto the roller pins.
3. Fully open the oven door, horizontal with floor (Figure 30).
4. Lift and turn/push the levers on both of the door hinge locks up towards and into the oven frame to the locked position (Figure 31).
5. Close the oven door.

Oven Baking

For best cooking results, preheat the oven before baking cookies, breads, cakes, pies, pastries, etc. There is no need to preheat the oven for roasting meat or baking casseroles. The cooking times and temperatures needed to bake a product may vary slightly from your previously owned appliance.

Baking Problems and Solutions

Baking Problems	Causes	Corrections
<p>Cookies and biscuits burn on the bottom.</p> 	<ul style="list-style-type: none"> • Cookies and biscuits put into oven before oven is preheated. • Oven rack is overcrowded. • Dark pan absorbs heat too fast. 	<ul style="list-style-type: none"> • Allow oven to preheat to desired temperature before placing food in oven. • Choose pan sizes that will permit at least 2" of air space (5.1 cm) on all sides when placed in the oven. • Use a medium weight shiny baking sheet.
<p>Cakes too dark on top or bottom</p> 	<ul style="list-style-type: none"> • Cakes put in oven before oven is preheated. • Rack position too high or too low. • Oven too hot. 	<ul style="list-style-type: none"> • Allow oven to preheat to the selected temperature before placing food in the oven. • Use proper rack position for baking needs. • Set oven temperature 25°F (13°C) lower than recommended.
<p>Cakes not done in center</p> 	<ul style="list-style-type: none"> • Oven too hot. • Incorrect pan size. • Pan not centered in oven. • Glass cookware slow heat conductor. 	<ul style="list-style-type: none"> • Set oven temperature 25°F (13°C) lower than recommended. • Use pan size suggested in recipe. • Use proper rack position and place pan so there are at least 2" (5.1 cm) of space on all sides of pan. • Reduce temperature and increase cook time or use shiny bakeware.
<p>Cakes not level.</p> 	<ul style="list-style-type: none"> • Oven not level. • Pan too close to oven wall or rack overcrowded. • Pan warped. • Oven light left on while baking. 	<ul style="list-style-type: none"> • Place a marked glass measuring cup filled with water on the center of the oven rack. If the water level is uneven, refer to the installation instructions for leveling the oven. • Use proper rack position and place pan so there are at least 2" (5.1 cm) of space on all sides of pan. • Do not use pans that are dented or warped. • Do not leave the oven light on while baking.
<p>Foods not done when cooking time is over.</p> 	<ul style="list-style-type: none"> • Oven too cool. • Oven overcrowded. • Oven door opened too frequently. 	<ul style="list-style-type: none"> • Set oven temperature 25°F (13°C) higher than suggested and bake for the recommended time. • Be sure to remove all pans from the oven except the ones to be used for baking. • Open oven door only after the shortest recommended baking time.

BEFORE YOU CALL

Solutions to Common Problems:

Before you call for service, review the following list. It may save you time and expense. Possible solutions are provided with the problem listed.

Problem	Cause / Solution
Entire appliance does not operate.	Appliance not connected. Make sure power cord is plugged properly into outlet. Check your fuse box or breaker box to make sure the circuit is active. Electrical power outage. Check house lights to be sure. Call your local electric company for service outage information.
Oven Problems	
Poor baking results.	Many factors affect baking results. Use proper oven rack position. Center food in the oven and space pans to allow air to circulate. Preheat the oven to the set temperature before placing food in the oven. Try adjusting the recipe's recommended temperature or baking time.
Flames inside oven or smoking from oven vent.	Excessive spills in oven. Grease or food spilled onto the oven bottom or oven cavity. Wipe up excessive spills before starting the oven. If flames or excessive smoke are present when using broil, see "Setting Broil" on page 20 .
Oven smokes excessively when broiling.	Incorrect setting. Follow the "Setting Broil" instructions on page 20 . Meat too close to the broil element or burner. Reposition the broil pan to provide proper clearance between the meat and broil element or burner. Remove excess fat from meat. Cut remaining fatty edges to prevent curling, but do not cut into lean. Grease build up on oven surfaces. Regular cleaning is necessary when broiling frequently. Grease or food splatters will cause excessive smoking.
Oven control panel beeps and displays any F or E code error.	Oven control has detected a fault or error condition. To clear the error, press the OFF key on the control panel. Once the error code is cleared, try the bake or broil function. If the F or E code error repeats, turn off the power to appliance, wait 5 minutes, and then repower the appliance. Set the clock with correct time of day. Try the bake or broil function again. If the fault recurs, press the OFF key to clear.
Oven portion of appliance does not operate.	The time of day is not set. The clock must be set in order to operate the oven. See "Setting the Time" on page 16 . Be sure the oven controls are set properly for the desired function. See "Setting Oven Controls" starting on page 16 and review instructions for the desired cooking function in this manual or see "Entire appliance does not operate." in this checklist.
Convection fan does not rotate.	Oven door is open. The convection fan will turn off if the oven door is opened when convection is active. Close the oven door. On gas models, the convection fan will begin to rotate about 6 minutes into the preheating process.

BEFORE YOU CALL

Problem	Cause / Solution
Cooktop Problems	
Surface element is too hot or not hot enough.	Incorrect surface control setting. Adjust power level setting.
Surface element does not heat or does not heat evenly.	Be sure the correct surface control knob is turned on for the element needed. Cookware is light weight or warped. Use only flat, evenly balanced, medium or heavy-weight cookware. Flat pans heat better than warped pans. Cookware materials and weight of the material affect heating. Heavy and medium-weight pans heat evenly. Because lightweight pans heat unevenly, foods may burn easily.
Drip bowls are pitting or rusting.	Foods with acids, such as tomatoes, will cause corrosion if allowed to stand in/on bowls. When cool, remove and wash drip bowls as soon as possible after a spill. Normal environment - Houses located along sea coasts are exposed to salt air. Protect bowls as much as possible from direct exposure to salt air.
Drip bowls have changing or distorting colors.	Bottom of cookware extends beyond surface element and touches cooktop surface. This can cause high enough temperatures to discolor drip bowls. DO NOT use cookware of this type. Pan sizes should match the size of the element. Replacement drip bowls may be purchased from your appliance dealer.
Other Problems	
Appliance is not level.	Be sure the floor is level, strong, and stable enough to adequately support the range. If the floor is sagging or sloping, contact a carpenter to correct the situation. Poor installation. Place the oven rack in the center of the oven. Place a level on the oven rack. Adjust the leveling legs at the base of the appliance until the rack is level. Kitchen cabinet alignment may make range appear not level. Be sure cabinets are square and have sufficient room for appliance clearance.
Cannot move appliance easily. Appliance must be accessible for service.	Cabinets not square or are built in too tightly. Contact the builder or installer to make the appliance accessible. Carpet interferes with appliance. Provide sufficient space so the appliance can be lifted over carpet. Installation over carpet is not advised. See the installation instructions for guidelines specific to your appliance.
Oven light does not work.	Be sure the oven light is secure in the socket. See "Replacing the Oven Light" on page 28 .

WARRANTY

Your appliance is covered by a one year limited warranty. For one year from your original date of purchase, Electrolux will pay all costs for repairing or replacing any parts of this appliance that prove to be defective in materials or workmanship when such appliance is installed, used and maintained in accordance with the provided instructions.

Exclusions

This warranty does not cover the following:

1. Products with original serial numbers that have been removed, altered or cannot be readily determined.
2. Product that has been transferred from its original owner to another party or removed outside the USA or Canada.
3. Rust on the interior or exterior of the unit.
4. Products purchased "as-is" are not covered by this warranty.
5. Food loss due to any refrigerator or freezer failures.
6. Products used in a commercial setting.
7. Service calls which do not involve malfunction or defects in materials or workmanship, or for appliances not in ordinary household use or used other than in accordance with the provided instructions.
8. Service calls to correct the installation of your appliance or to instruct you how to use your appliance.
9. Expenses for making the appliance accessible for servicing, such as removal of trim, cupboards, shelves, etc., which are not a part of the appliance when it is shipped from the factory.
10. Service calls to repair or replace appliance light bulbs, air filters, water filters, other consumables, or knobs, handles, or other cosmetic parts.
11. Surcharges including, but not limited to, any after hour, weekend, or holiday service calls, tolls, ferry trip charges, or mileage expense for service calls to remote areas, including the state of Alaska.
12. Damages to the finish of appliance or home incurred during installation, including but not limited to floors, cabinets, walls, etc.
13. Damages caused by: services performed by unauthorized service companies; use of parts other than genuine Electrolux parts or parts obtained from persons other than authorized service companies; or external causes such as abuse, misuse, inadequate power supply, accidents, fires, or acts of God.

DISCLAIMER OF IMPLIED WARRANTIES; LIMITATION OF REMEDIES

CUSTOMER'S SOLE AND EXCLUSIVE REMEDY UNDER THIS LIMITED WARRANTY SHALL BE PRODUCT REPAIR OR REPLACEMENT AS PROVIDED HEREIN. CLAIMS BASED ON IMPLIED WARRANTIES, INCLUDING WARRANTIES OF MERCHANTABILITY OR FITNESS FOR A PARTICULAR PURPOSE, ARE LIMITED TO ONE YEAR OR THE SHORTEST PERIOD ALLOWED BY LAW, BUT NOT LESS THAN ONE YEAR. ELECTROLUX SHALL NOT BE LIABLE FOR CONSEQUENTIAL OR INCIDENTAL DAMAGES SUCH AS PROPERTY DAMAGE AND INCIDENTAL EXPENSES RESULTING FROM ANY BREACH OF THIS WRITTEN LIMITED WARRANTY OR ANY IMPLIED WARRANTY. SOME STATES AND PROVINCES DO NOT ALLOW THE EXCLUSION OR LIMITATION OF INCIDENTAL OR CONSEQUENTIAL DAMAGES, OR LIMITATIONS ON THE DURATION OF IMPLIED WARRANTIES, SO THESE LIMITATIONS OR EXCLUSIONS MAY NOT APPLY TO YOU. THIS WRITTEN WARRANTY GIVES YOU SPECIFIC LEGAL RIGHTS. YOU MAY ALSO HAVE OTHER RIGHTS THAT VARY FROM STATE TO STATE.

If You Need Service

Keep your receipt, delivery slip, or some other appropriate payment record to establish the warranty period should service be required. If service is performed, it is in your best interest to obtain and keep all receipts. Service under this warranty must be obtained by contacting Electrolux at the addresses or phone numbers below.

This warranty only applies in the USA and Canada. In the USA, your appliance is warranted by Electrolux Major Appliances North America, a division of Electrolux Home Products, Inc. In Canada, your appliance is warranted by Electrolux Canada Corp. Electrolux authorizes no person to change or add to any obligations under this warranty. Obligations for service and parts under this warranty must be performed by Electrolux or an authorized service company. Product features or specifications as described or illustrated are subject to change without notice.

USA
1.800.944.9044
Electrolux Home Products, Inc.
10200 David Taylor Drive
Charlotte, NC 28262



Canada
1.800.265.8352
Electrolux Canada Corp.
5855 Terry Fox Way
Mississauga, Ontario, Canada
L5V 3E4