



Under-Cabinet Hoods

F30WC19E C/S/B

30" Wall Mount



Signature Features

2-Speed Fan

Effectively and quietly removes smoke, vapors and smells from the kitchen.

Cooking Surface Light

Provides ample illumination of the cooking surface.

Dishwasher-Safe Filter

Dishwasher-safe for easy cleaning.

Convertible Exhaust Duct Options¹

Ventilation is convertible to be either ducted outside, or recirculated inside requiring no ducting.

Features

Nominal Width	30"
Installation Type	Wall Mount
Style	Under-Cabinet
Controls	Rocker Switch
Air Discharge	Vertical or Horizontal
Air Delivery (CFM) ²	190 (7" Round)/ 160 (Vert./Horiz.)
Blower Type	Fan
Fan Speeds	2
Cooktop Light(s)	1
Dishwasher-Safe Filter(s)	Yes
Exhaust Duct	Convertible ³
Duct Required	7" Round or 3-1/4" x 10"

Optional Accessories

Duct-Free Kit (Single-Pack)	PN# 5304455848
Duct-Free Kit (6-Pack)	PN# DFKIT306PK

Specifications

Product Dimensions -	
Height	6"
Width	30"
Depth	17-1/2"
Voltage Rating	120V / 60Hz / 15A
Connected Load (kW Rating) @ 120 Volts ⁴	TBD
Amps @ 120 Volts	2.5
Shipping Weight (Approx.)	13 Lbs.
Sones Rating	6.5

¹Recirculated option requires use of optional Duct-Free Kit.
²190 CFM external exhaust (7" round-vertical only). 160 CFM external exhaust (3-1/4" x 10").

³Ventilation system is preset to recirculate air inside with no ducting. Converting to exterior exhaust is optional.

⁴For use on adequately wired 120V, dedicated circuit having 2-wire service with a separate ground wire. Appliance must be grounded for safe operation.

NOTE: Always consult local and national electric codes. Check local building codes for installation requirements, as they may vary per locale. Refer to Product Installation Guide for detailed installation instructions on the web at frigidaire.com.

Specifications subject to change.

Available in:



Stainless (C)

White (S)

Black (B)

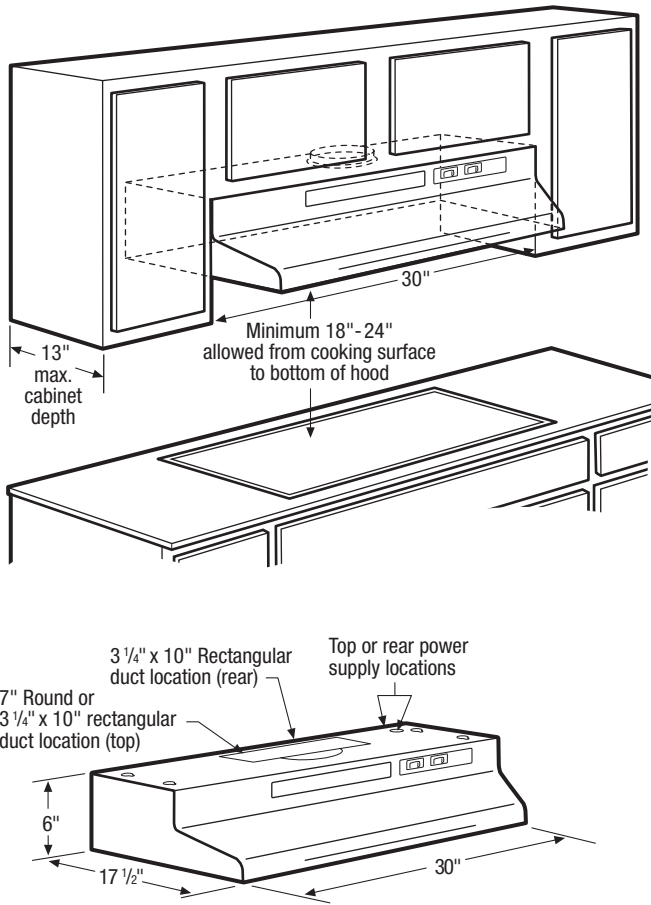

Exhaust Options

Vent hood can be vertically or horizontally ducted outside using round or rectangular duct; or recirculated inside with no ducting required. For detailed duct preparation and installation specifications, refer to installation instructions on web.

Outside Vertical – 7" Round Duct Cabinet Bottom

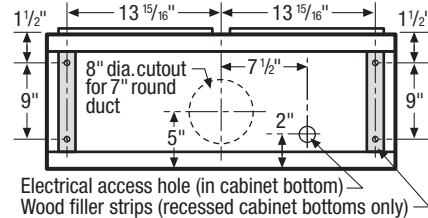

Outside Vertical – 3 1/4" x 10" Rectangular Duct Cabinet Bottom

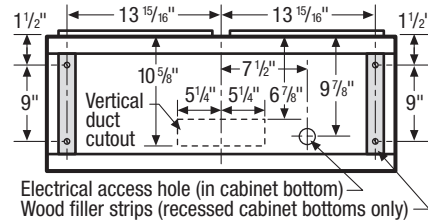

Outside Horizontal – 3 1/4" x 10" Rectangular Duct Cabinet Front

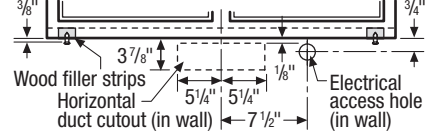

Under-Cabinet Hood Specifications

- Product Shipping Weight (Approx.) - 13 Lbs.
- Wall-Mount Installation - can be ducted vertically or horizontally.
- Ventilation system is preset to recirculate air inside with no ducting system required. Exhausting air outside is optional, using either vertical or horizontal ducting system. (Refer to Ducted Option Specifications for outside ventilation.)
- Sones Rating - 6.5
- Voltage Rating - 120V / 60 Hz / 15 Amps
- Connected Load (kW Rating) @ 120 Volts = TBD (For use on adequately wired 120V, dedicated circuit having 2-wire service with a separate ground wire. Appliance must be grounded for safe operation.)
- Amps @ 120 Volts = 2.5 Amps
- Always consult local and national electric codes. Check local building codes for installation requirements, as they may vary per locale.
- Connect vent hood with copper wire only.
- Minimum installation height allowed from bottom of hood to cooking surface is 18" - 24".
- To improve performance, optional Duct-Free Kit recommended for use with recirculating system.

Ducted Option Specifications

- For outside ventilation.
- Exhaust Duct Required - 7" round or 3-1/4" x 10" (3-1/4" x 10" to 6"-round transition duct can be used if needed)
- For most efficient airflow exhaust, use a straight run or as few elbows as possible.
- Use metallic flex ducting only to connect rigid duct directly to transitions (if allowed by code).
- Thermal breaks such as short section of nonmetallic duct, should be used in areas of extreme cold.
- Cold weather installations should have additional backdraft damper installed.
- Refer to installation instructions on web for detailed duct preparation and converting exhaust vent blower system for exterior exhaust ventilation.

Note: For planning purposes only. Refer to Product Installation Guide on the web at frigidaire.com for detailed instructions.

Optional Accessories

- Duct-Free Kit (Single-Pack) - (PN# 5304455848).
- Duct-Free Kit (6-Pack) - (PN# DFKIT306PK).

Accessories information available on the web at frigidaire.com



Use these dimensions and clearance instructions for planning purposes only. For detailed installation instructions, refer to installation guide, packed with product, or on the web at frigidaire.com.



When installing appliances adjacent to each other, 20" minimum distance between each appliance required.

When installing built-in cooking appliances in combination, 2" minimum visible gap between appliance faceplates required.



When installing side-by-side refrigerator adjacent to wall, cabinet or another appliance that extends beyond front edge of unit, 20" minimum clearance recommended to allow for optimum 120° to 180° door swing, providing complete drawer/crisper access and removal.

When installing appliance with sliding drawer, swinging or drop-down door directly across from obstructions, provide sufficient clearance for drawer extension or door swings.



When installing appliance with sliding drawer or drop-down door directly across from obstructions, provide sufficient clearance for drawer extension or door swing.

When installing appliance with sliding drawer or drop-down door adjacent to wall, cabinet, or other obstruction that extends beyond front edge of appliance, allow 2" minimum clearance between drawer or door and obstruction.

Use these dimensions and clearance instructions for planning purposes only. For detailed installation instructions, refer to installation guide, packed with product, or on the web at frigidaire.com.

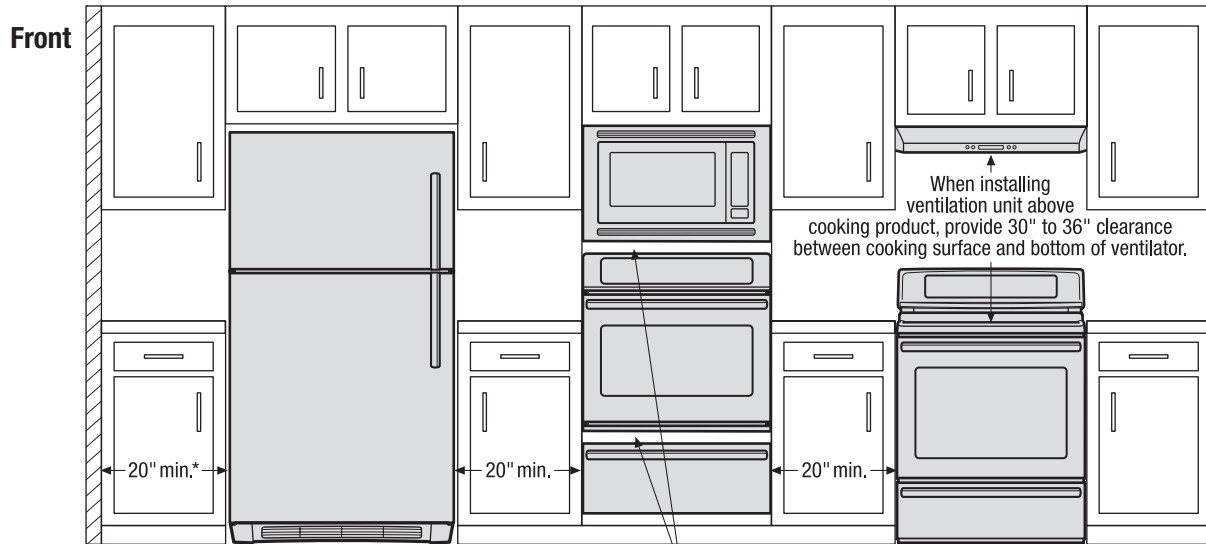

When installing appliances adjacent to each other, 20" minimum distance between each appliance required.

When installing built-in cooking appliances in combination, 2" minimum visible gap between appliance faceplates required.

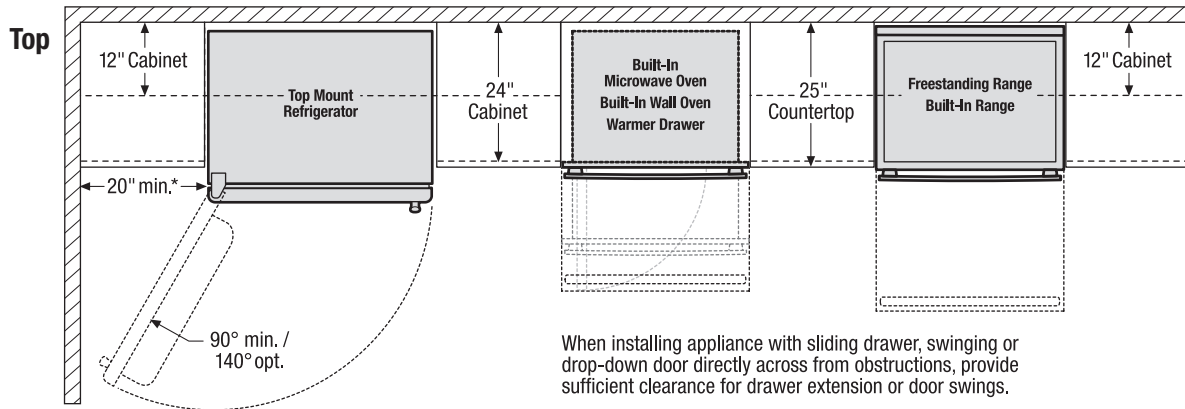

When installing appliance with sliding drawer, swinging or drop-down door directly across from obstructions, provide sufficient clearance for drawer extension or door swings.

*When installing refrigerator adjacent to wall, cabinet or other appliance that extends beyond front edge of unit, 20" minimum clearance recommended to allow for optimum 140° door swing, providing complete crisper access and removal. (Absolute 3" minimum clearance will ONLY allow for 90° door swing which will provide limited crisper access with restricted removal.)

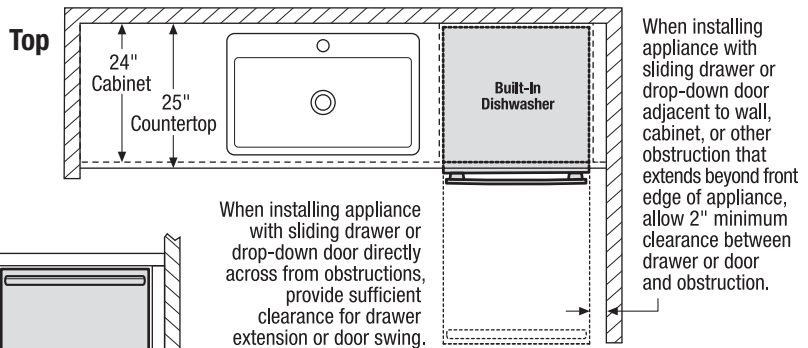

When installing appliance with sliding drawer or drop-down door directly across from obstructions, provide sufficient clearance for drawer extension or door swing.

