

FRIGIDAIRE

PROFESSIONAL®



# Convection Oven & Microwave

## *use & care*

Introduction . . . . .	2
Important Safety Instructions . . . . .	3
Precautions Microwave Energy . . . . .	4
Names Of Oven Parts And Accessories . . . . .	8
Operation . . . . .	9
Maintenance . . . . .	16

Cleaning And Care . . . . .	17-19
Warranty . . . . .	21

A06823446 (November 2022)

# 2 INTRODUCTION

---

Welcome to our *family*

Thank you for bringing Frigidaire into your home! We see your purchase as the beginning of a long relationship together.

This manual is your resource for the use and care of your product. Please read it before using your appliance. Keep it handy for quick reference. If something doesn't seem right, the troubleshooting section will help you with common issues.

FAQs, helpful tips and videos, cleaning products, and kitchen and home accessories are available at [www.frigidaire.com](http://www.frigidaire.com).

We are here for you! Visit our website, chat with an agent, or call us if you need help. We may be able to help you avoid a service visit. If you do need service, we can get that started for you.

Let's make it official! Be sure to register your product.

Keep your product info here so it's easy to find.

Model Number: \_\_\_\_\_

Serial Number: \_\_\_\_\_

Purchase Date: \_\_\_\_\_

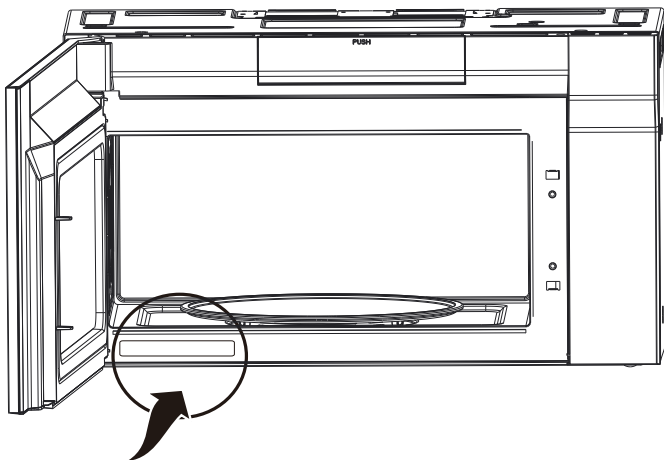

Serial Number Location

---

# IMPORTANT SAFETY INSTRUCTIONS

# 3

Read all instructions before using this appliance.

This manual contains important safety symbols and instructions. Please pay attention to these symbols and follow all instructions given.

Do not attempt to install or operate your appliance until you have read the safety precautions in this manual. Safety items throughout this manual are labeled with a WARNING or CAUTION statement based on the risk type.

Warnings and important instructions appearing in this guide are not meant to cover all possible conditions and situations that may occur. Common sense, caution, and care must be exercised with installing, maintaining, or operating your appliance.

## DEFINITIONS

 This is the safety alert symbol. It is used to alert of potential personal injury hazards. Obey all safety messages that follow this symbol to avoid possible injury or death.

### WARNING

Indicates a potentially hazardous situation which, if not avoided, may result in death or serious injury.

### CAUTION

Indicates a potentially hazardous situation which, if not avoided, may result in minor or moderate injury.

### NOTE

Indicates a short, informal reference - something written down to assist the memory or for future reference.

### IMPORTANT

Indicates installation, operation or maintenance information which is important but not hazard-related.

### NOTE

## ELECTRICAL REQUIREMENTS

Product rating is 120 volts AC, 60 Hertz, 1.5 kilowatts and 13.5 amps. This product must be connected to a separate and dedicated supply circuit of the proper voltage and frequency. Wire size must conform to the requirements of the National Electrical Code or the prevailing local code for this kilowatt rating. The power supply cord and plug should be brought to a separate and dedicated 15- to 20- ampere branch circuit single grounded outlet. The outlet box should be located in the cabinet above the microwave oven. The outlet box and supply circuit should be installed by a qualified electrician and conform to the National Electrical Code or the prevailing local code.

### IMPORTANT

1. If you have any questions about the grounding or electrical instructions, consult a qualified electrician or service person.
2. Neither Electrolux nor the dealer can accept any liability for damage to the microwave oven or personal injury resulting from failure to observe the correct electrical connection procedures.

## SAVE THESE INSTRUCTIONS

# 4

## PRECAUTIONS MICROWAVE ENERGY

### PRECAUTIONS TO AVOID POSSIBLE EXPOSURE TO EXCESSIVE MICROWAVE ENERGY

Do not attempt to operate this oven with the door open since open door operation can result in harmful exposure to microwave energy. It is important not to defeat or tamper with the safety interlocks.

Do not place any object between the oven front face and the door or allow soil or cleaner residue to accumulate on sealing surfaces.

#### **WARNING**

To reduce the risk of burns, electric shock, fire, injury to persons or exposure to excessive microwave energy:

Do not operate the oven if it is damaged. It is particularly important that the oven door close properly and that there is no damage to the:

- (1) DOOR (bent)
- (2) HINGES AND LATCHES (broken or loosened)
- (3) DOOR SEALS AND SEALING SURFACES.

The oven should not be adjusted or repaired by anyone except properly qualified service personnel.

**This device complies with part 18 of the FCC Rules. (Only for USA)**

### RADIO INTERFERENCE

- Operation of the microwave oven may cause interference to your radio, TV or similar equipment.
- When there is interference, it may be reduced or eliminated by taking the following measures:
  - Clean door and sealing surface of the oven.
  - Reorient the receiving antenna of radio or television.
  - Relocate the microwave oven with respect to the receiver.
  - Move the microwave oven away from the receiver.
  - Plug the microwave oven into a different outlet so that microwave oven and receiver are on different branch circuits.

### UTENSILS

#### **CAUTION**

- Personal Injury Hazard

- Tightly-closed utensils could explode. Closed containers should be opened and plastic pouches should be pierced before cooking.
- See the instructions on "Materials you can use in microwave oven or to be avoided in microwave oven."  
There may be certain non-metallic utensils that are not safe to use for microwaving. If in doubt, you can test the utensil in question following the procedure below.

#### **Utensil Test:**

- Fill a microwave-safe container with 1 cup of cold water (250ml) along with the utensil in question.
- Cook on maximum power for 1 minute.
- Carefully feel the utensil. If the empty utensil is warm, do not use it for microwave cooking.
- Do not exceed 1 minute cooking time.

**SAVE THESE INSTRUCTIONS**

# IMPORTANT SAFETY INSTRUCTIONS

When using electrical appliances basic safety precautions should be followed, including the following:

## **WARNING**

To reduce the risk of burns, electric shock, fire, injury to persons or exposure to excessive microwave energy:

- Read all instructions before using the appliance.
- Read and follow the specific: "PRECAUTIONS TO AVOID POSSIBLE EXPOSURE TO EXCESSIVE MICROWAVE ENERGY" found on page 4.
- This appliance must be grounded. Connect only to properly grounded outlet. See "GROUNDING INSTRUCTIONS" found on page 6.
- Install or locate this appliance only in accordance with the provided installation instructions.
- Some products such as whole eggs and sealed containers - for example, closed glass jars - are able to explode and should not be heated in this oven.
- Use this appliance only for its intended use as described in the manual. Do not use corrosive chemicals or vapors in this appliance. This type of oven is specifically designed to heat, cook or dry food. It is not designed for industrial or laboratory use.
- **HOT CONTENTS CAN CAUSE SEVERE BURNS. DO NOT ALLOW CHILDREN TO USE THE MICROWAVE.** Use caution when removing hot items.
- Do not operate this appliance if it has a damaged cord or plug, if it is not working properly, or if it has been damaged or dropped.
- This appliance should be serviced only by qualified service personnel. Contact nearest authorized service facility for examination, repair, or adjustment.
- Do not cover or block any openings on the appliance.
- Do not store this appliance outdoors. Do not use this product near water - for example, near a kitchen sink, in a wet basement, near a swimming pool, or similar location.
- Do not immerse cord or plug in water.
- Keep cord away from heated surface.
- Do not let cord hang over edge of table or counter. When cleaning surfaces of door and oven that comes together on closing the door, use only mild, nonabrasive soaps, or detergent applied with a sponge or soft cloth.
- To reduce the risk of fire in the oven cavity:
  - Do not overcook food. Carefully attend appliance when paper, plastic, or other combustible materials are placed inside the oven to facilitate cooking.
  - Remove wire twist-ties from paper or plastic bag before when placing bag in oven.
  - If material inside of the oven ignite, keep oven door closed, turn oven off, and disconnect the power cord, or shut off power at the fuse or circuit breaker panel.
  - Do not use the cavity for storage purposes. Do not leave paper products, cooking utensils, or food in the cavity when not in use.
- Liquids, such as water, coffee, or tea are able to be overheated beyond the boiling point without appearing to be boiling. Visible bubbling or boiling when the container is removed from the microwave oven is not always present. **THIS COULD RESULT IN VERY HOT LIQUID SUDDENLY BOILING OVER WHEN THE CONTAINER IS DISTURBED OR A UTENSIL IS INSERTED INTO THE LIQUID.** To reduce the risk of injury to persons:
  - Do not overheat the liquid.
  - Stir the liquid both before and halfway through heating it.
  - Do not use straight-sided containers with narrow necks.
  - After heating, allow the container to stand in the microwave oven for a short time before removing the container.
  - Use extreme care when inserting a spoon or other utensil into the container.
  - Oversized food or oversized metal utensils should not be inserted in a microwave/toaster oven as they may create a fire or risk of electric shock. Do not clean with metal scouring pads. Pieces can burn off the pad and touch electrical parts involving a risk of electric shock.
  - Do not use paper products when appliance is operated in the toaster, air fry or convection mode.
  - Do not store any materials, other than manufacturer's recommended accessories, in this oven when not in use.
  - Do not cover racks or any other part of the oven with metal foil. This will cause over- heating of the oven.
  - Clean Ventilation Hoods Frequently -Grease should not be allowed to accumulate on hood or filter.
  - When flaming foods under the hood, turn the fan on.
  - Use care when cleaning the vent-hood filter. Corrosive cleaning agents, such as lye-based oven cleaners, may damage the filter.
  - Suitable for use above both gas and electric cooking equipment.

## SAVE THESE INSTRUCTIONS

# 6

## IMPORTANT SAFETY INSTRUCTIONS

### GROUNDING INSTRUCTIONS

This appliance must be grounded. In the event of an electrical short circuit, grounding reduces the risk of electric shock by providing an escape wire for the electric current. This appliance is equipped with a cord having a grounding wire with a grounding plug. The plug must be plugged into an outlet that is properly installed and grounded.

#### **WARNING**

Improper use of the grounding can result in a risk of electric shock.

Consult a qualified electrician or serviceman if the grounding instructions are not completely understood, or if doubt exists as to whether the appliance is properly grounded. If it is necessary to use an extension cord, use only a 3-wire extension cord that has a 3-blade grounded plug, and 3-slot receptacle that will accept the plug on the appliance. The marked rating of the extension cord shall be equal to or greater than the electrical rating of the appliance.

#### **IMPORTANT**

1. If you have any questions about the grounding or electrical instructions, consult a qualified electrician or service person.
2. Neither Electrolux nor the dealer can accept any liability for damage to the microwave oven or personal injury resulting from failure to observe the correct electrical connection procedures.

#### **DANGER**

##### Electric Shock Hazard

Touching some of the internal components can cause serious personal injury or death. Do not disassemble this appliance.

#### **WARNING**

##### Electric Shock Hazard

Improper use of the grounding can result in electric shock. Do not plug into an outlet until appliance is properly installed and grounded.

- A short power supply cord is provided to reduce the risks resulting from becoming entangled in or tripping over a longer cord.
- Longer cord sets or extension cords are available and may be used if care is exercised in their use.
- If a long cord or extension cord is used:
  - The marked electrical rating of the cord set or extension cord should be at least as great as the electrical rating of the appliance.
  - The extension cord must be a grounding-type 3-wire cord.
  - The longer cord should be arranged so that it will not drape over the counter top or tabletop where it can be pulled on by children or tripped over unintentionally.

**SAVE THESE INSTRUCTIONS**

# IMPORTANT SAFETY INSTRUCTIONS

## Materials you can use in microwave oven

Browning dish	Follow manufacturer instructions. The bottom of browning dish must be at least 3/16 inch (5mm) above the turntable. Incorrect usage may cause the turntable to break.
Dinnerware	Microwave-safe only. Follow manufacturer's instructions. Do not use cracked or chipped dishes.
Glass jars	Always remove lid. Use only to heat food until just warm. Most glass jars are not heat resistant and may break.
Glassware	Heat-resistant oven glassware only. Make sure there is no metallic trim. Do not use cracked or chipped dishes.
Oven cooking bags	Follow manufacturer instructions. Do not close with metal tie. Make slits to allow steam to escape.
Paper plates and cups	Use for short term cooking/warming only. Do not leave oven unattended while cooking.
Paper towels	Use to cover food for reheating and absorbing fat. Use with supervision for a short-term cooking only.
Parchment paper	Use as a cover to prevent splattering or a wrap for steaming.
Plastic	Microwave-safe only. Follow the manufacturer instructions. Should be labeled "Microwave Safe". Some plastic containers soften, as the food inside gets hot. "Boiling bags" and tightly closed plastic bags should be slit, pierced or vented as directed by package.
Plastic wrap	Microwave-safe only. Use to cover food during cooking to retain moisture. Do not allow plastic wrap to touch food.
Thermometers	Microwave-safe only (meat and candy thermometers).
Wax paper	Use as a cover to prevent splattering and retain moisture.

## Materials to be avoided in microwave oven

Aluminum tray	May cause arcing. Transfer food into microwave-safe dish.
Food carton with metal handle	May cause arcing. Transfer food into microwave-safe dish.
Metal or metal-trimmed utensils	Metal shields the food from microwave energy. Metal trim may cause arcing.
Metal twist ties	May cause arcing and could cause a fire in the oven.
Paper bags	May cause a fire in the oven.
Plastic foam	Plastic foam may melt or contaminate the liquid inside when exposed to high temperature.
Wood	Wood will dry out when used in the microwave oven and may split or crack.

# 8 NAMES OF OVEN PARTS AND ACCESSORIES

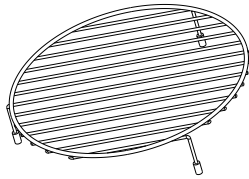
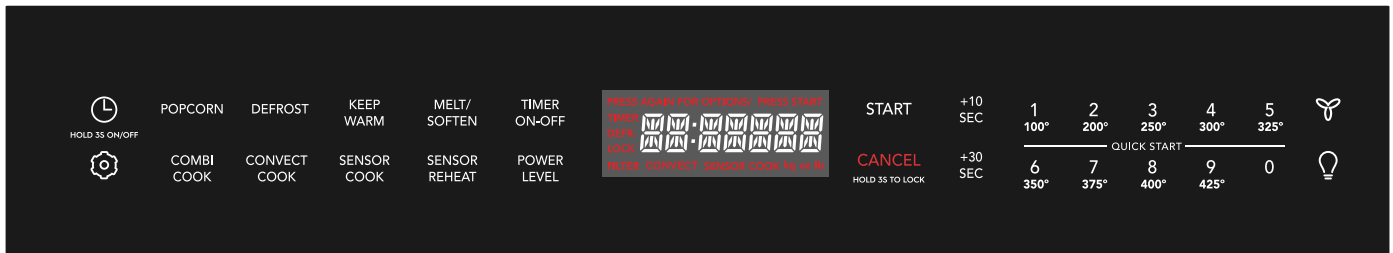

Round Wire Rack

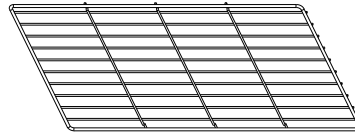

Wire Rack

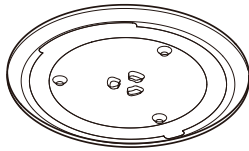

Glass Turntable

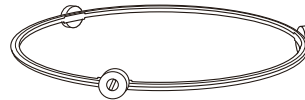

Turntable Ring Assembly

**→ NOTE**  
The Round Wire Rack can be used for Convection cooking and Microwave Cooking functions.



**→ NOTE**  
The wire rack can be used for microwave cooking only.



- Before operating your new appliance make sure you read and understand this Use and Care Guide completely.
- The clock can be disabled when the microwave is first plugged in and the CANCEL key is selected. To re-enable the clock follow clock instructions.

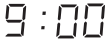
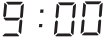

## Setting the clock

### Example: setting clock display for 9:00:



1. Touch  pad once .   
HOLD 3S ON/OFF HOLD 3S ON/OFF
2. Enter time using number pads.  PRESS START
3. Touch START pad . 

## Setting the clock ON/OFF

### Example: to turn off clock display:

1. Touch  and hold pad .   
HOLD 3S ON/OFF HOLD 3S ON/OFF
2. Time will display, after 3s, OFF will display. 

### Example: to turn on clock display:





1. Hold the clock button for 3s and the clock will show in the display and when ON is shown in the display the clock will remain on.   
HOLD 3S ON/OFF
2. Tap the clock button to see the current time if the display is off.   
HOLD 3S ON/OFF

## CHILD LOCK



- Suppose you want to lock or unlock the controls.

Touch:	Display Shows:
1. CANCEL (for 3 seconds)	LOCKED <small>LOCK</small> XX:XX (current time will display after 2 seconds)

## VENT FAN

Touch:	Display Shows:
1.  x 1	HIGH
2.  x 2	MED
3.  x 3	LOW
4.  x 4	OFF

## SURFACE LIGHT

Touch:	Display Shows:
1.  x 1	HIGH
2.  x 2	LOW
3.  x 3	OFF

# 10 OPERATION

## Convection Cooking

### For Best Results...

Always use the round wire rack when convection cooking. Reduce package/recipe temperature 25°F for baked goods. The round wire rack is required for good air circulation and even browning.

### Using convection with preheating

- Suppose you want to convection cook at 400°F for 5 minutes with preheating.

**Touch:** \_\_\_\_\_ **Display Shows:** \_\_\_\_\_

1. **CONVECT COOK** PRESS AGAIN FOR OPTIONS/ CONVECT **PREHEAT ENTER TEMP**
2. **(8)** PRESS START **400 F**  
CONVECT
3. **START**  
(When oven is preheated it will beep.) CONVECT COOK **PREHEAT**
4. Temperature will display **400F PREHEAT END** if no action is taken. CONVECT COOK
5. Place food in oven and enter time CONVECT COOK **ENTER TIME**
6. **(5) (0) (0)** PRESS START **5:00**  
CONVECT COOK
7. **START**  
**5:00**  
CONVECT COOK  
Time counting down

### Using convection without preheating

- Suppose you want to convection cook at 400°F for 5 minutes without preheating.

**Touch:** \_\_\_\_\_ **Display Shows:** \_\_\_\_\_

1. **CONVECT COOK** x2 PRESS AGAIN FOR OPTIONS/ CONVECT **BAKE/ROAST ENTER TEMP**
2. **(8)** PRESS START **400 F**  
CONVECT
3. **START** CONVECT **ENTER TIME**
4. **(5) (0) (0)** PRESS START **5:00**  
CONVECT
5. **START**  
**5:00**  
CONVECT COOK  
Time counting down

## Broil-High

- Suppose you want Broil-High for 10 minutes.

**Touch:** \_\_\_\_\_ **Display Shows:** \_\_\_\_\_

1. **CONVECT COOK** x3 PRESS AGAIN FOR OPTIONS/ CONVECT **BROIL HIGH ENTER TIME**
2. **(1) (0) (0) (0)** PRESS START **10:00**  
CONVECT
3. **START**  
**10:00**  
CONVECT COOK  
Time counting down

## Broil-Low

- Suppose you want to Broil-Low for 5 minutes.

**Touch:** \_\_\_\_\_ **Display Shows:** \_\_\_\_\_

1. **CONVECT COOK** x4 PRESS AGAIN FOR OPTIONS/ CONVECT **BROIL LOW ENTER TIME**
2. **(5) (0) (0)** PRESS START **5:00**  
CONVECT
3. **START**  
**5:00**  
CONVECT COOK  
Time counting down

## KEEP WARM

- Suppose you want to keep warm for 5 minutes.

**Touch:** \_\_\_\_\_ **Display Shows:** \_\_\_\_\_

1. **KEEP WARM** PRESS START **ENTER TIME**  
CONVECT
2. **(5) (0) (0)** PRESS START **5:00**  
CONVECT
3. **START**  
**5:00**  
CONVECT COOK  
Time counting down

## NOTE

When cooking is finished the oven will beep and the display will show REMOVE FOOD FAN COOLING. After the food is removed from the oven the display will continue to show FAN COOLING.

## COMBI COOK

Suppose you want to Bake for 5 minutes at 250°F.

Touch:	Display Shows:
1. COMBI COOK X1	<small>PRESS AGAIN FOR OPTIONS/ CONVECT</small> BAKE <small>PRESS AGAIN FOR OPTIONS/ CONVECT</small> 325 F <small>CONVECT</small>
2. 3	<small>PRESS AGAIN FOR OPTIONS/ CONVECT</small> 250 F <small>CONVECT</small>
3. START	ENTER TIME <small>CONVECT</small>
4. 5 0 0	<small>PRESS AGAIN FOR OPTIONS/ CONVECT</small> 5:00 <small>CONVECT</small>
5. START	5:00 <small>CONVECT COOK</small> Time counting down

## Power chart of bake

Degree(F)	Press number	Microwave
250	3	10%
300	4	
325	5 (default)	
350	6	
375	7	
400	8	
425	9	

## Power chart of roast

Degree(F)	Press number	Microwave
300	4	30%
325	5	
350	6 (default)	
375	7	
400	8	
425	9	

## Using the +10 SEC /+ 30 SEC key

This feature will let you quickly start or add 10 or 30 seconds.

Touch the +10 SEC /+30 SEC pad to:+10 SEC / +30 SEC

1. Start cooking for 10 seconds/30 seconds at 100% power level.
2. Extend cooking time in multiples of 10 seconds/30 seconds each time this pad is touched during microwave cooking.

## NOTE

Touch the +10 SEC or +30 SEC to add time to any cooking cycle in progress.

## POPCORN

- Suppose you want to cook 3.0 oz. popcorn.

**Touch:** **Display Shows:**

1. POPCORN	<small>PRESS AGAIN FOR OPTIONS/ CONVECT</small> 3.3 oz
2. POPCORN	<small>PRESS AGAIN FOR OPTIONS/ CONVECT</small> 3.0 oz
3. START	Time counting down

Touch POPCORN	Amount
X1	3.3 oz
X2	3.0 oz
X3	1.75 oz

# 12 OPERATION

## MELT/SOFTEN

- Suppose you want to melt 2 sticks of Butter.

Touch:	Display Shows:
1. MELT/ SOFTEN X1	<small>PRESS AGAIN FOR OPTIONS/ PRESS START</small> MELT BUTTER
2. START	ENTER 1-2 STK
3. (2)	<small>PRESS START</small> 2 STICK
4. START	Time counting down

Touch MELT/ SOFTEN	Food	Amount
x1	Melt Butter	1 or 2 sticks
x2	Melt Chocolate	2/4/8 oz
x3	Soften Ice Cream	Pint/1.5Quart
x4	Soften Cream Cheese	3 or 8 oz

## DEFROST

- Suppose you want to defrost 1.2 lbs of meat.

Touch:	Display Shows:
1. DEFROST X1	<small>PRESS AGAIN FOR OPTIONS/ PRESS START</small> MEAT
2. START	ENTER WEIGHT
3. (1) (2)	<small>PRESS START</small> 1.2 lb
4. START	Time counting down

Touch DEFROST	Menu	Amount
x1	Meat	0.1-6.0 lbs.
x2	Poultry	0.1-6.0 lbs.
x3	Fish	0.1-6.0 lbs.

## SENSOR COOK

- Suppose you want to cook a frozen dinner.

Touch:	Display Shows:
1. SENSOR COOK	<small>PRESS AGAIN FOR OPTIONS/ PRESS START</small> BACON <small>SENSOR</small>
2. SENSOR COOK	<small>PRESS AGAIN FOR OPTIONS/ PRESS START</small> POTATO <small>SENSOR</small>
3. SENSOR COOK	<small>PRESS AGAIN FOR OPTIONS/ PRESS START</small> FROZEN DINNER <small>SENSOR</small>
4. START	FROZEN DINNER <small>SENSOR COOK</small>

### NOTE

When the food is near completion, the display will show time count down.

Touch sensor cook once, Bacon displays, then Touch start to enter the slice setting, 1-3 SLE will display, touch 1, 2, or 3 slices.

Touch SENSOR REHEAT	Food	Amount
X1	Bacon	1-3 slices
X2	Potato	1-4 pcs
X3	Frozen Dinner	10oz/20oz.
X4	Rice	1-2 cups
X5	Frozen Breakfast	8oz/12oz
X6	Fresh Veggie	1-4 CUPS
X7	Frozen Veggie	1-4 CUPS
X8	Fresh Pizza	12oz
X9	Frozen Pizza	12oz

## SENSOR REHEAT

- Suppose you want to reheat Pizza.

Touch:	Display Shows:
1. SENSOR REHEAT	<small>PRESS AGAIN FOR OPTIONS/ PRESS START</small> BEVERAGE <small>SENSOR</small>
2. SENSOR REHEAT	<small>PRESS AGAIN FOR OPTIONS/ PRESS START</small> SOUP SAUCE <small>SENSOR</small>
3. SENSOR REHEAT	<small>PRESS AGAIN FOR OPTIONS/ PRESS START</small> PIZZA <small>SENSOR</small>
4. START	PIZZA <small>SENSOR COOK</small>

## NOTE

When the food is near completion, the display will show time count down.

Touch SENSOR REHEAT	Food	Amount
X1	Beverage	1-2 Cups
X2	Soup/Sauce	1-2 Cups
X3	Pizza	2-3 Slices
X4	Dinner Plate	1-2 Plate
X5	Casserole	10.5 oz Serving
X6	Rolls	1-3 Pieces

## USING ONE TOUCH START

Touch 1 - 9 for 1 - 9 minutes microwave cooking. The cooking will start 2 seconds after your selection.

- Suppose you want to microwave for 3 minutes.

**Touch:** \_\_\_\_\_ **Display Shows:** \_\_\_\_\_

1. (3)

3:00  
PRESS START

Time counting down automatically after 2 seconds

## NOTE

Touch the +10 SEC or +30 SEC to add time to any cooking cycle in progress.

## NOTE

"Food" will be displayed if a quick start cooking cycle or +10 SEC / +30 SEC key is touch more than 5 minutes after the door of microwave oven is closed. You must open then close the door again to clear "Food" from the display.

## MULTI-STAGE COOKING

For best results, some recipes call for different power levels during a cook cycle. You can program your microwave for two power level stages during the cooking cycle.

- Suppose you want to set a 2-stage cook cycle. The first stage is a 3 minute cook time at 80% cook power then a 7 minute cook time at 50% cook power.

**Touch:** \_\_\_\_\_ **Display Shows:** \_\_\_\_\_

(3) (0) (0)

3:00  
PRESS START

1. To set a 3 minute cook time for first stage.

2. POWER LEVEL X3

PL-80  
PRESS START

3. (7) (0) (0)

- To set a 7 minute cook power for the second stage.

7:00  
PRESS START

4. POWER LEVEL X6

PL-50  
PRESS START

5. START

3:00  
COOK  
Time counting down

## NOTE

At the end of 3 minutes the display will change to 7 minutes.

## NOTE

Defrost and auto menu can not be set in multi-stage cook.

# 14 OPERATION

## SETTING THE TIMER

- Your microwave oven can be used as a kitchen timer. You can set up to 99:99. The kitchen timer can be used while the microwave oven is running.
- Suppose you want to set a timer for 10:59.

Touch:	Display Shows:
1. TIMER ON-OFF	TIMER ENTER TIME
2. (1) (0) (5) (9)	TIMER 10:59
3. TIMER ON-OFF	TIMER 10:59 (Timer counts down)

### NOTE

There are not any other programs during the kitchen timer. During the process of setting the timer, if you touch CANCEL or there is not any operation in 5 minutes, the oven will enter to waiting state.

### NOTE

The display will return to default setting after 15 minutes if a cooking cycle is stopped and not restarted.

## MICROWAVE AT LOWER POWER LEVEL

Your Over the Range Microwave Oven can be programmed for 99 minutes 99 seconds (99 :99). Always enter the seconds after the minutes, even if they are both zeros.

- Suppose you want to cook for 2 minutes at 90% power.

Touch:	Display Shows:
1. (2) (0) (0)	2:00 <small>PRESS START</small>
2. POWER LEVEL	PL-HI <small>PRESS START</small>
3. POWER LEVEL	PL-90 <small>PRESS START</small>
4. START	2:00 <small>COOK</small>

Time counting down

## POWER CHART

TOUCH	POWER LEVEL	DISPLAY
POWER LEVEL x 1	100%	PL-HI
POWER LEVEL x 2	90%	PL-90
POWER LEVEL x 3	80%	PL-80
POWER LEVEL x 4	70%	PL-70
POWER LEVEL x 5	60%	PL-60
POWER LEVEL x 6	50%	PL-50
POWER LEVEL x 7	40%	PL-40
POWER LEVEL x 8	30%	PL-30
POWER LEVEL x 9	20%	PL-20
POWER LEVEL x 10	10%	PL-10
POWER LEVEL x 11	0%	PL-0

## USER SETTING

### Volume

- Suppose you want to set the volume for "off".

Touch:	Display Shows:
1.  x 1	<small>PRESS AGAIN FOR OPTIONS/ PRESS START</small> VOLUME LOW  <small>PRESS AGAIN FOR OPTIONS/ PRESS START</small> VOLUME MED (after 3 seconds)  <small>PRESS AGAIN FOR OPTIONS/ PRESS START</small> VOLUME HIGH (after 3 seconds)  <small>PRESS AGAIN FOR OPTIONS/ PRESS START</small> VOLUME OFF (after 3 seconds)
2. START	OFF

## TURNTABLE ON/OFF

**Touch:**

**Display Shows:**

1.  x 2

PRESS AGAIN FOR OPTIONS/ PRESS START  
TURNTABLE  
PRESS AGAIN FOR OPTIONS/ PRESS START  
ON

2. START

TT OFF

ON

2. START

OFF

YES

NO

## SETTING WEIGHT LB/KG

- Suppose you want to change from lb to kg.

**Touch:**

**Display Shows:**

1.  x 3

PRESS AGAIN FOR OPTIONS/ PRESS START  
LB / KG

2. START

KG  
kg

## DEMO SETTING

- Suppose you want to turn on Demo Mode.

**Touch:**

**Display Shows:**

1.  x 6

PRESS AGAIN FOR OPTIONS/ PRESS START  
DEMO OFF

2. START

ON

## SETTING FILTER

**Touch:**

**Display Shows:**

1.  x 5

The display will scroll.  
When you see the  
desired setting touch  
Start.

PRESS AGAIN FOR OPTIONS/ PRESS START  
ON  
FILTER  
PRESS AGAIN FOR OPTIONS/ PRESS START  
YES  
FILTER  
PRESS AGAIN FOR OPTIONS/ PRESS START  
OFF  
FILTER  
PRESS AGAIN FOR OPTIONS/ PRESS START  
YES  
FILTER  
PRESS AGAIN FOR OPTIONS/ PRESS START  
RESET  
FILTER  
PRESS AGAIN FOR OPTIONS/ PRESS START  
YES  
FILTER  
PRESS AGAIN FOR OPTIONS/ PRESS START  
RESET  
FILTER  
PRESS AGAIN FOR OPTIONS/ PRESS START  
NO  
FILTER

## SETTING LANGUAGE

- When previous language is english, suppose you want to set the language.

**Touch:**

**Display Shows:**

1.  x 4

PRESS AGAIN FOR OPTIONS/ PRESS START  
LANGUAGE  
PRESS AGAIN FOR OPTIONS/ PRESS START  
FRENCH

2. START

FRANCAIS

When the setting is completed ,the current time will display 2 seconds later,if the time is not set,the oven will return to waiting state.

### NOTE

When START is pressed and the previous setting was English it will be set to French. If you want switch back to English you will have to again press START four times and then press START.

On yes	FILTER indicator light on by default for recirculation. The FILTER indicator light will track the vent fan on time.
Off yes	Turn off the FILTER indicator light when vented to outside. The FILTER indicator light will not track the vent fan on time.
Reset yes	Reset FILTER Indicator The filter indicator light on the display will track the vent fan on time. When it is time to change the charcoal filter, the FILTER indicator light will come on. Use RESET YES to reset the vent motor tracking time and to turn off the FILTER indicator light.
Reset no	Will not reset the time for FILTER indicator light.

# 16 MAINTENANCE

## Troubleshooting

Check your problem by using the chart below and try the solutions for each problem. If the microwave oven still does not work properly, contact the nearest authorized service center.

TROUBLE	POSSIBLE CAUSE	POSSIBLE REMEDY
Oven will not start	<ul style="list-style-type: none"><li>• Electrical cord for oven is not plugged in.</li><li>• Door is open.</li><li>• Cord not plugged in.</li></ul>	<ul style="list-style-type: none"><li>• Plug into the outlet.</li><li>• Close the door and try again.</li></ul>
Arcing or sparking	<ul style="list-style-type: none"><li>• Materials to be avoided in microwave oven were used.</li><li>• The oven is operated when empty.</li><li>• Spilled food remains in the cavity.</li></ul>	<ul style="list-style-type: none"><li>• Use microwave-safe cookware only.</li><li>• Do not operate with oven empty.</li><li>• Clean cavity with wet towel.</li></ul>
Unevenly cooked foods	<ul style="list-style-type: none"><li>• Materials to be avoided in microwave oven were used.</li><li>• Food is not defrosted completely.</li><li>• Cooking time, power level is not suitable.</li><li>• Food is not turned or stirred.</li></ul>	<ul style="list-style-type: none"><li>• Use microwave-safe cookware only.</li><li>• Completely defrost food.</li><li>• Use correct cooking time, power level.</li><li>• Turn or stir food.</li></ul>
Overcooked foods	<ul style="list-style-type: none"><li>• Cooking time, power level is not suitable.</li></ul>	<ul style="list-style-type: none"><li>• Use correct cooking time, power level.</li></ul>
Undercooked foods	<ul style="list-style-type: none"><li>• Materials to be avoided in microwave oven were used.</li><li>• Food is not defrosted completely.</li><li>• Oven ventilation ports are restricted.</li><li>• Cooking time, power level is not suitable.</li></ul>	<ul style="list-style-type: none"><li>• Use microwave-safe cookware only.</li><li>• Completely defrost food.</li><li>• Check to see that oven ventilation ports are not restricted.</li><li>• Use correct cooking time, power level.</li></ul>
Improper defrosting	<ul style="list-style-type: none"><li>• Materials to be avoided in microwave oven were used.</li><li>• Cooking time, power level is not suitable.</li><li>• Food is not turned or stirred.</li></ul>	<ul style="list-style-type: none"><li>• Use microwave-safe cookware only.</li><li>• Use correct cooking time, power level.</li><li>• Turn or stir food.</li></ul>



**Disconnect the power cord or leave the door open to deactivate the oven during cleaning. Disconnect the power cord before replacing filters and lights.**

## EXTERIOR

The outside surface is precoated steel and plastic. Clean the outside with mild soap and water; rinse and dry with a soft cloth. Do not use any type of household or abrasive cleaner.

## DOOR

Wipe the window on both sides with a soft cloth to remove any spills or splatters. Metal parts will be easier to maintain if wiped frequently with a soft cloth. Avoid the use of spray and other harsh cleaners as they may stain, streak or dull the door surface.

## EASY CARE™ STAINLESS STEEL / SMUDGE-PROOF™ STAINLESS STEEL / BLACK STAINLESS STEEL (SOME MODELS)

Your microwave oven (some models) may have a Stainless Steel finish or coating. Clean the stainless with warm soapy water using a clean sponge or cloth. Rinse with clean water and dry with a soft clean cloth. **DO NOT** use ANY store bought cleaners like Stainless Steel cleaners or any other types of cleaners containing any abrasive, chlorides, chlorines or ammonia. It is recommended to use mild dish soap and water or a 50/50 solution of water and vinegar.

## TOUCH CONTROL PANEL

Care should be taken in cleaning the touch control panel. If the control panel becomes soiled, open the microwave oven door before cleaning. Wipe the panel with a cloth dampened slightly with water only. Dry with a soft cloth. Do not scrub or use any sort of chemical cleaners. Close door and touch **Cancel**

## INTERIOR

To clean the interior surfaces, wipe with a soft cloth and warm water. **DO NOT USE ABRASIVE OR HARSH CLEANERS OR SCOURING PADS.** For heavier soil, use baking soda or a mild soap; rinse thoroughly with hot water. The round wire rack and shelf can be cleaned with hot soapy water, rinsed and dried.

## WAVEGUIDE COVER

The waveguide cover is located on the right side in the microwave oven cavity. It is made from mica so requires special care. Keep the waveguide cover clean to assure good microwave oven performance. Carefully wipe with a damp cloth any food splatters from the surface of the cover immediately after they occur. Built-up splashes may overheat and cause smoke or possibly catch fire.

**DO NOT REMOVE THE WAVEGUIDE COVER.**

## ODOR REMOVAL

Occasionally, a cooking odor may remain in the microwave oven. To remove, combine 1 cup water, grated peel and juice of 1 lemon in a 2-cup glass measuring cup.

Boil for several minutes using 100% power.

Allow to set in microwave oven until cool. Wipe interior with a soft cloth.

## TURNTABLE/TURNTABLE SUPPORT

The turntable and turntable support can be removed for easy cleaning. Wash them in mild, sudsy water; for stubborn stains use a mild cleanser and non-abrasive scouring sponge. They are also dishwasher-proof. Use upper

wirerack of dishwasher. The turntable motor shaft is not sealed, so excess water or spills should be wiped up immediately.

# 18 CLEANING AND CARE

Disconnect the power cord or leave the door open to deactivate the oven during cleaning. Disconnect the power cord before replacing filters and lights.

## Charcoal filter replacement

Charcoal filter part number **FRPAMRAF**

To order parts call **800-599-7569**

Charcoal Filter when installed in your microwave oven, is used for nonvented, recirculated Installation. When it is time to replace the charcoal filter, the FILTER light on display will turn on.

If your microwave is vented to the outside, then you can turn off the filter light in the settings.

1. Disconnect power to the microwave oven at the circuit breaker panel or by unplugging.
2. Press the "Push" position on the cover.
3. And then open the cover.

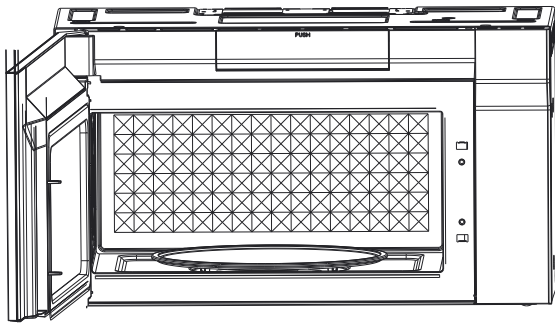

4. Remove the charcoal filter by pushing the top of the filter inwards, then pull it forward out from the unit.

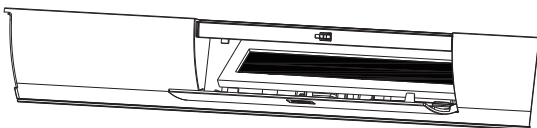
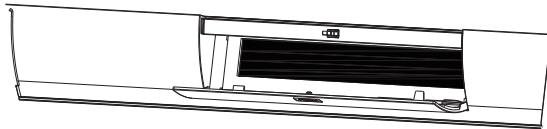

5. Slide the top of the new charcoal filter the top area of the filter cavity.

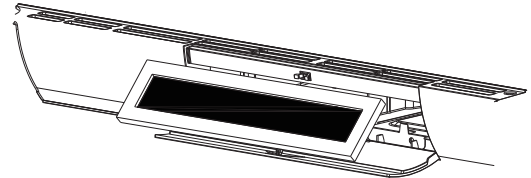

6. Press the bottom of charcoal filter to place it into the correct position.

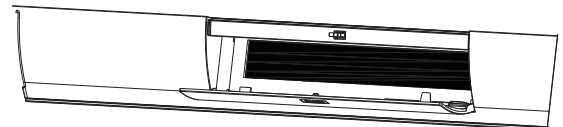

7. Press the "Push" to close the cover

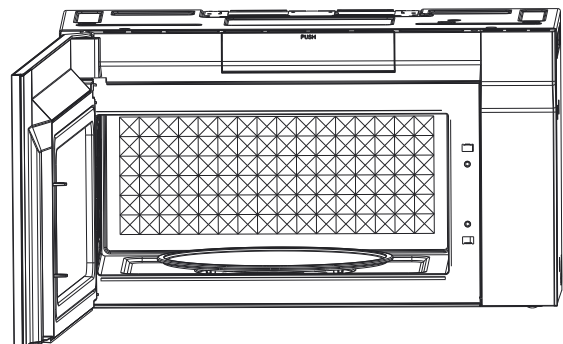

## WARNING

Disconnect the power cord before cleaning or leave the door open to deactivate the oven during cleaning.

## CLEANING THE GREASE FILTER

The oven ventilation grease filters should be removed and cleaned often; generally at least once every month.

## CAUTION

To avoid risk of personal injury or property damage, do not operate oven hood without filter properly in place.

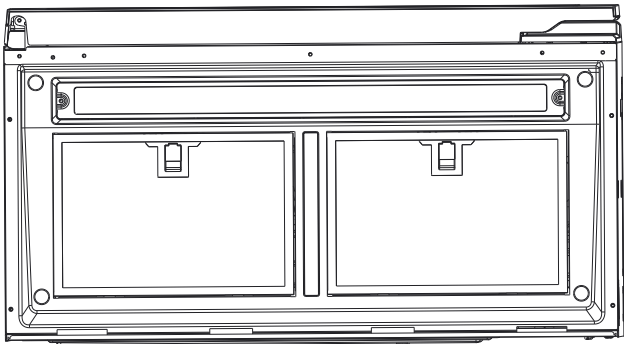

1. To remove the grease filter, pull the lever, then pull filter downward. The filter will drop out.

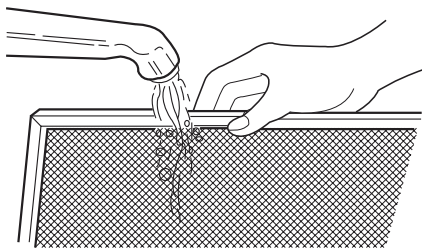

2. Soak the grease filter in hot water using a mild detergent. Rinse well and shake to dry or wash grease filter in dishwasher. It is best to place in upper rack of dishwasher for cleaning.

## NOTE

Do not use ammonia cleaner. The ammonia cleaner may corrode and darken the aluminum on the filter.

3. To reinstall the grease filter, infix the hooks into the holes of base plate, then pull the lever and toward oven to lock.

## CAUTION

### CAUTION GREASE FILTER

Filter should be cleaned at least once a month. Never operate the fan or microwave oven without the filter in place.

1. Pull down slightly on the tab toward the front of the microwave oven and remove the filter.
2. Soak the filter in a sink or dish pan filled with hot water and detergent. DO NOT use ammonia or other alkali; they will react with the filter material and darken it.
3. Agitate and scrub with a brush to remove embedded dirt.
4. Rinse thoroughly and shake dry.
5. Replace by fitting the filter back into the opening.

# 20 SERVICE CALL CHECK

Please check the following before calling for service:

Place one cup of water in a glass measuring cup in the microwave oven and close the door securely. Operate the microwave oven for one minute at HIGH 100%.

- A Does the microwave oven light come on? YES \_\_\_ NO \_\_\_
- B Does the cooling fan work? (Put your hand at top above Display) YES \_\_\_ NO \_\_\_
- C Does the turntable rotate? (It is normal for the turntable to turn in either direction.) YES \_\_\_ NO \_\_\_
- D Is the water in the microwave oven warm? YES \_\_\_ NO \_\_\_

**If “NO” is the answer to any of the above questions, please check electrical outlet, fuse and/or circuit breaker. If they are functioning properly, CONTACT YOUR NEAREST ELECTROLUX AUTHORIZED SER-VICER.**

**A microwave oven should never be serviced by a “do-it-yourself” repair person.**



## NOTES

1. If time appearing in the display is counting down very rapidly, check Demonstration Mode on page 15.

## SPECIFICATIONS

AC Line Voltage:	Single phase 120V, 60Hz, AC only
AC Power Required:	1500W 13.5amps
Output Power*:	900 W
Frequency:	2450 MHz (Class B/Group2)**
Outside Dimensions:	75.9 "(W) x 44.6 "(D) x 40.8 "(H)
Cavity Dimensions:	54.0"(W) x 25.2 "(D) x 37.36 "(H)
Microwave oven Capacity***:	1.9 Cu.Ft.
Cooking Uniformity:	Turntable
Weight:	Approx. (net) 79.1 lbs, (gross) 84.2 lbs
Work/Night Light:	2*1.2W LED
Oven Light:	1*1.2W LED

\* The International Electrotechnical Commission’s standardized method for measuring output wattage. This test method is widely recognized.

\*\* This is the classification of ISM (Industrial, Scientific and Medical) equipment described in the International Standard CISPR11.

\*\*\* Internal capacity is calculated by measuring maximum width, depth and height. Actual capacity for holding food is less. In compliance with standards set by:

**FCC**

- Federal Communications Commission Authorized.

**DHHS**

- Complies with Department of Health and Human Services (DHHS) rule, CFR, Title 21, Chapter I, Subchapter J.



- This symbol on the nameplate means the product is listed by Underwriters Laboratories, Inc.



- This symbol on the nameplate means the product is listed by Underwriters Laboratories, Inc. for use in USA or Canada.

Your appliance is covered by a one year limited warranty. For one year from your original date of purchase, Electrolux will pay all costs for repairing or replacing any parts of this appliance that prove to be defective in materials or workmanship when such appliance is installed, used and maintained in accordance with the provided instructions.

## Exclusions

This warranty does not cover the following:

1. Products with original serial numbers that have been removed, altered or cannot be readily determined.
2. Product that has been transferred from its original owner to another party or removed outside the USA or Canada.
3. Rust on the interior or exterior of the unit.
4. Products purchased "as-is" are not covered by this warranty.
5. Food loss due to any refrigerator or freezer failures.
6. Products used in a commercial setting.
7. Service calls which do not involve malfunction or defects in materials or workmanship, or for appliances not in ordinary household use or used other than in accordance with the provided instructions.
8. Service calls to correct the installation of your appliance or to instruct you how to use your appliance.
9. Expenses for making the appliance accessible for servicing, such as removal of trim, cupboards, shelves, etc., which are not a part of the appliance when it is shipped from the factory.
10. Service calls to repair or replace appliance light bulbs, air filters, water filters, other consumables, or knobs, handles, or other cosmetic parts.
11. Surcharges including, but not limited to, any after hour, weekend, or holiday service calls, tolls, ferry trip charges, or mileage expense for service calls to remote areas, including the state of Alaska.
12. Damages to the finish of appliance or home incurred during installation, including but not limited to floors, cabinets, walls, etc.
13. Damages caused by: services performed by unauthorized service companies; use of parts other than genuine Electrolux parts or parts obtained from persons other than authorized service companies; or external causes such as abuse, misuse, inadequate power supply, accidents, fires, or acts of God.

## DISCLAIMER OF IMPLIED WARRANTIES; LIMITATION OF REMEDIES

CUSTOMER'S SOLE AND EXCLUSIVE REMEDY UNDER THIS LIMITED WARRANTY SHALL BE PRODUCT REPAIR OR REPLACEMENT AS PROVIDED HEREIN. CLAIMS BASED ON IMPLIED WARRANTIES, INCLUDING WARRANTIES OF MERCHANTABILITY OR FITNESS FOR A PARTICULAR PURPOSE, ARE LIMITED TO ONE YEAR OR THE SHORTEST PERIOD ALLOWED BY LAW, BUT NOT LESS THAN ONE YEAR. ELECTROLUX SHALL NOT BE LIABLE FOR CONSEQUENTIAL OR INCIDENTAL DAMAGES SUCH AS PROPERTY DAMAGE AND INCIDENTAL EXPENSES RESULTING FROM ANY BREACH OF THIS WRITTEN LIMITED WARRANTY OR ANY IMPLIED WARRANTY. SOME STATES AND PROVINCES DO NOT ALLOW THE EXCLUSION OR LIMITATION OF INCIDENTAL OR CONSEQUENTIAL DAMAGES, OR LIMITATIONS ON THE DURATION OF IMPLIED WARRANTIES, SO THESE LIMITATIONS OR EXCLUSIONS MAY NOT APPLY TO YOU. THIS WRITTEN WARRANTY GIVES YOU SPECIFIC LEGAL RIGHTS. YOU MAY ALSO HAVE OTHER RIGHTS THAT VARY FROM STATE TO STATE.

## If You Need Service

Keep your receipt, delivery slip, or some other appropriate payment record to establish the warranty period should service be required. If service is performed, it is in your best interest to obtain and keep all receipts. Service under this warranty must be obtained by contacting Electrolux at the addresses or phone numbers below.

This warranty only applies in the USA and Canada. In the USA, your appliance is warranted by Electrolux Major Appliances North America, a division of Electrolux Home Products, Inc. In Canada, your appliance is warranted by Electrolux Canada Corp. Electrolux authorizes no person to change or add to any obligations under this warranty. Obligations for service and parts under this warranty must be performed by Electrolux or an authorized service company. Product features or specifications as described or illustrated are subject to change without notice.

**USA**  
**1-800-374-4432**

Frigidaire  
10200 David Taylor Drive  
Charlotte, NC 28262



**Electrolux**

**Canada**

**1.800.265.8352**

Electrolux Canada Corp.  
5855 Terry Fox Way  
Mississauga, Ontario, Canada  
L5V 3E4

# FRIGIDAIRE®

welcome *home*

Our home is your home. Visit us if you need help with any of these things:



owner support



accessories



service



registration

(See your registration card for more information.)

Frigidaire.com  
1-800-374-4432

Frigidaire.ca  
1-800-265-8352