

FRIGIDAIRE

All about the

Use & Care

of your Refrigerator

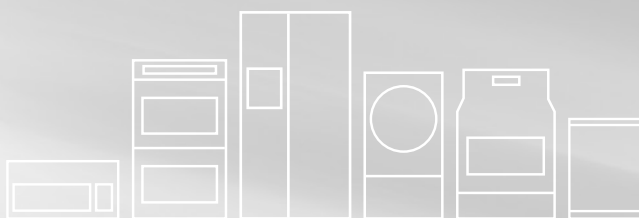

TABLE OF CONTENTS

Important Safety Instructions.....	2	Changing The Filter.....	11
Feature Overview.....	4	Interior Lighting.....	12
Installation.....	5	Storage Features.....	13
Door Removal.....	8	Energy-Saving Tips.....	14
Electronic Control.....	8	Care & Cleaning.....	15
Sabbath Mode.....	10	Before you Call.....	17
Alerts.....	10	Major Appliance Warranty.....	19

IMPORTANT SAFETY INSTRUCTIONS



WARNING

Please read all instructions before using this refrigerator.

Definitions

 This is the safety alert symbol. It is used to alert you to potential personal injury hazards. Obey all safety messages that follow this symbol to avoid possible injury or death.



DANGER

DANGER indicates an imminently hazardous situation which, if not avoided, will result in death or serious injury.



WARNING

WARNING indicates a potentially hazardous situation which, if not avoided, could result in death or serious injury.



CAUTION

CAUTION indicates a potentially hazardous situation which, if not avoided, may result in minor or moderate injury.



IMPORTANT

IMPORTANT indicates installation, operation or maintenance information which is important but not hazard-related.



WARNING

For your safety

- Do not store or use gasoline or other flammable vapors and liquids in the vicinity of this or any other appliance. Read product labels for flammability and other warnings.
- Do not operate the unit in the presence of explosive fumes.
- Remove and discard any spacers used to secure the shelves during shipping. Small objects are a choke hazard to children.
- Remove all staples from the carton. Staples can cause severe cuts, and also destroy finishes if they come in contact with other appliances or furniture.



Installation Checklist

Doors

- Handles are secure and tight
- Door seals completely to cabinet on all sides
- Refrigerator door is level across the top

Leveling

- Refrigerator is level, side-to-side and tilted $\frac{1}{4}$ " (6mm) front-to-back
- Kick plate is properly attached to refrigerator
- Cabinet is setting solid on all corners

Electrical Power

- House power turned on
- Refrigerator plugged in

Final Checks

- Shipping material removed
- Fresh food temperatures set
- Crisper humidity controls set
- Registration card sent in



WARNING

Child Safety

- Destroy carton, plastic bags, and any exterior wrapping material immediately after the unit is unpacked. Children should never use these items for play. Cartons covered with rugs, bedspreads, plastic sheets or stretch wrap may become airtight chambers and can quickly cause suffocation.
- An empty, discarded icebox, refrigerator, or freezer is a very dangerous attraction to children.
- Remove the door(s) of any appliance that is not in use, even if it is being discarded.

IMPORTANT SAFETY INSTRUCTIONS



WARNING

Risk of child entrapment

Child entrapment and suffocation are not problems of the past. Junked or abandoned appliances are still dangerous – even if they will sit for “just a few days”. If you are getting rid of your old appliance, please follow the instructions below to help prevent accidents.

We strongly encourage responsible appliance recycling/disposal methods. Check with your utility company or visit www.recyclemyoldfridge.com for more information on recycling your old appliance.

Before you throw away your old appliance:

- Remove door.
- Leave shelves in place so children may not easily climb inside.
- Have the refrigerator removed by a qualified technician.

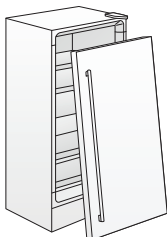

WARNING

Avoid fire hazard or electric shock. Do not use an extension cord or an adapter plug. Do not remove any prong from power cord.

Grounding type wall receptacle

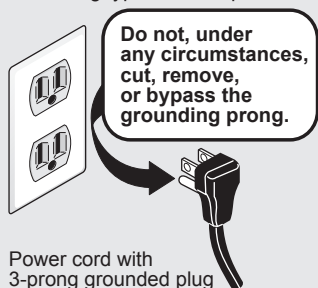

WARNING

Electrical Information

These guidelines must be followed to ensure that safety mechanisms in the design of this appliance will operate properly.

- Refer to the serial plate for correct electrical rating. The power cord of the appliance is equipped with a three-prong grounding plug for your protection against electrical shock hazards. It must be plugged directly into a properly grounded three-prong receptacle, protected with a 15-amp time delay fuse or circuit breaker. The receptacle must be installed in accordance with the local codes and ordinances. Consult a qualified electrician. Receptacles protected by Ground Fault Circuit Interrupters (GFCI) are NOT RECOMMENDED. Do NOT use an extension cord or adapter plug.
- If the power cord is damaged, it should be replaced by an authorized service technician to prevent any risk.
- Never unplug the unit by pulling on the power cord. Always grip the plug firmly, and pull straight out from the receptacle to prevent damaging the power cord.
- Unplug the appliance before cleaning and before replacing a light bulb to avoid electrical shock.
- If voltage varies by 10% or more, appliance performance may be affected. Operating the unit with insufficient power can damage the compressor. Such damage is not covered under the warranty. If you suspect your household voltage is high or low, consult your power company for testing.
- To prevent the appliance from being turned off accidentally, do not plug unit into an outlet controlled by a wall switch or pull cord.



IMPORTANT

To disconnect power to the unit, unplug the unit or switch the breaker that supplies power to the unit to the off position.

FEATURE OVERVIEW

Understanding Features and Terms

Your Frigidaire refrigerator is designed for optimal convenience and storage flexibility. The illustration below is provided to assist you with familiarizing yourself with product features and terminology.

NOTE

Features may vary according to model.

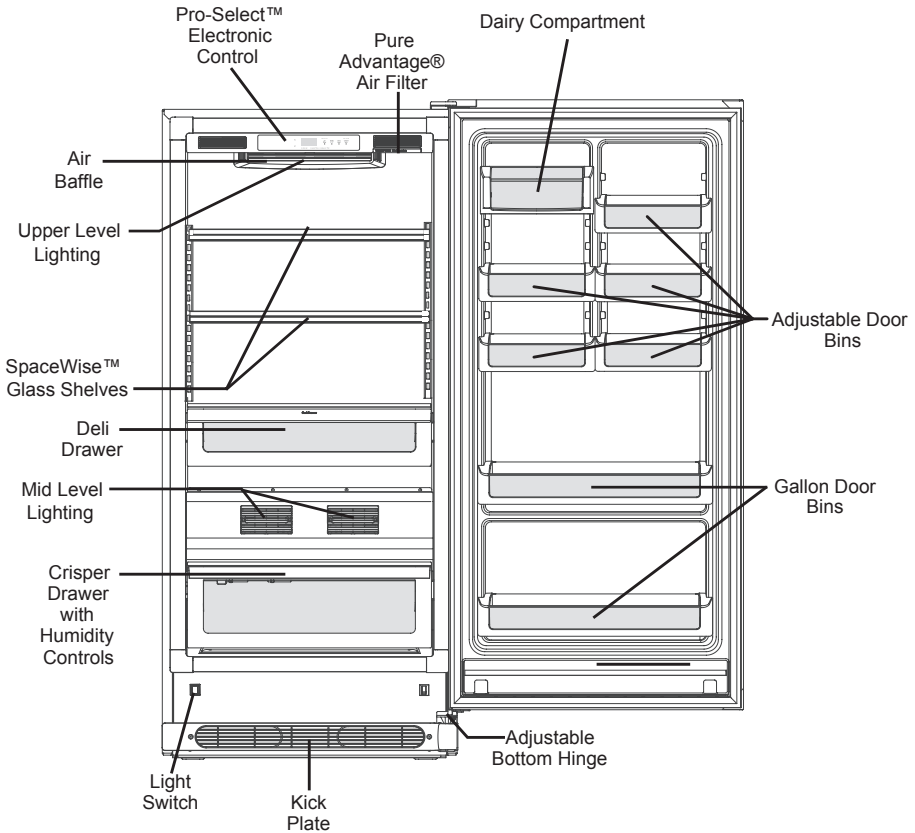

Required Tools:

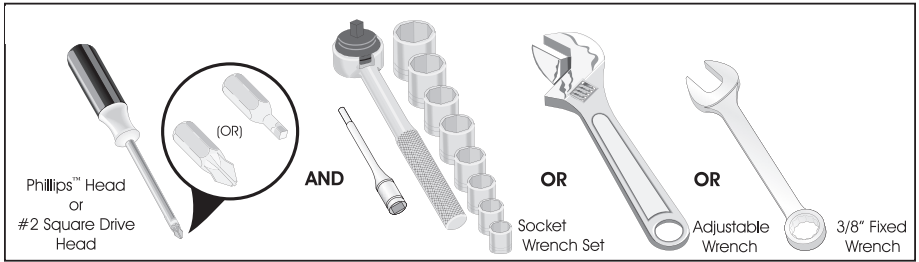

This Use & Care Guide provides general operating instructions for your model. Use the refrigerator only as instructed in this Use & Care Guide. Before starting the refrigerator, follow these important first steps.

Location

- Choose a place that is near a grounded electrical outlet. **Do Not** use an extension cord or an adapter plug.
- If possible, place the refrigerator out of direct sunlight and away from the range, dishwasher or other heat sources.
- The refrigerator must be installed on a floor that is level and strong enough to support a fully loaded refrigerator.



CAUTION

DO NOT install the refrigerator where the temperature will drop below 55°F (13°C) or rise above 110°F (43°C). The compressor will not be able to maintain proper temperatures inside the refrigerator.

DO NOT block the kick plate on the lower front of your refrigerator. Sufficient air circulation is essential for the proper operation of your refrigerator.

NOTE

If your refrigerator is placed with the door hinge side against a wall, you may have to allow additional space so the door can be opened wider.

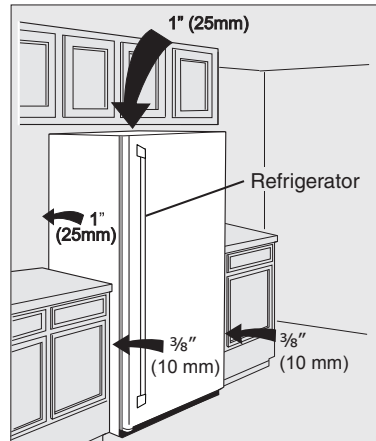

Installation

Installation clearances:

- Allow the following clearances for ease of installation, proper air circulation, and plumbing and electrical connections:
 - Sides - 3/8"
 - Top and Back - 1"
- Allow for trim kit if it is to be installed with the unit.

INSTALLATION

Door Handle Mounting Instructions

1. Remove handle from carton and any other protective packaging.
2. Position refrigerator handle end caps over upper and lower pre-installed shoulder bolts (A) that are fastened into door, ensuring the holes for the set screws are facing towards the outside of door if a single unit installation or the freezer door (if installing the matching freezer).
3. While holding handle firmly against door, fasten upper and lower Allen set screws (B) with supplied Allen wrench.
4. Repeat steps 2 and 3 to install freezer handle (if installing the matching freezer). Ensure the holes for the set screws are facing towards the refrigerator door.

Frigidaire Gallery®

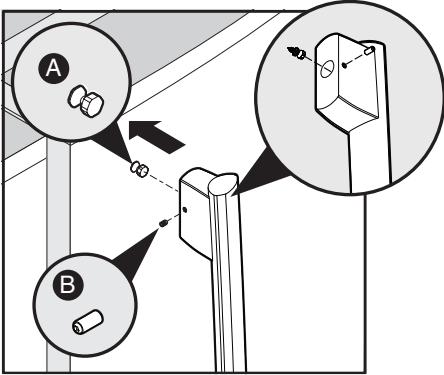

Frigidaire Professional®

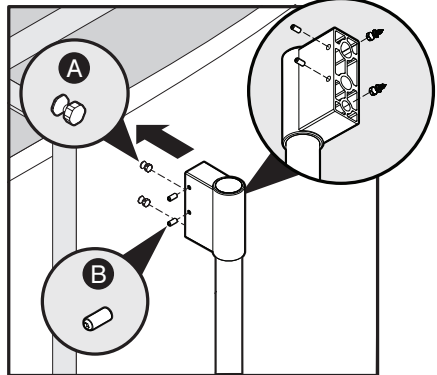

Single Unit Installation

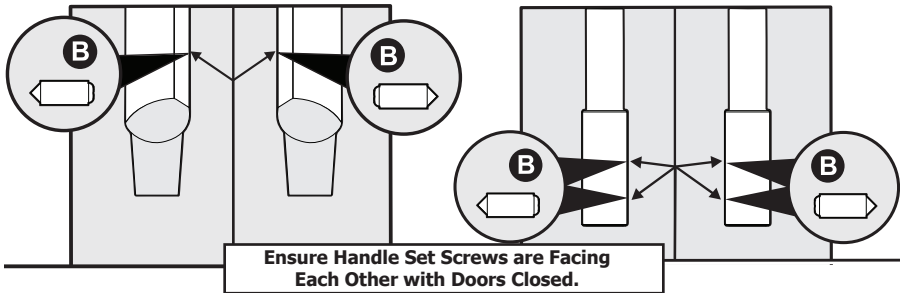

Matching Refrigerator and Freezer Door Handle Installation

NOTE

All set screws should be tightened and sub-flush (Allen set screw should be seated just below the surface of the end cap) of handle end cap. The end caps should be drawn tight to refrigerator door with no gaps.

Kick Plate Removal

To remove the kick plate, use a Phillips head screwdriver and remove the two screws holding the kick plate to the cabinet. Then pull the kick plate away from the unit.

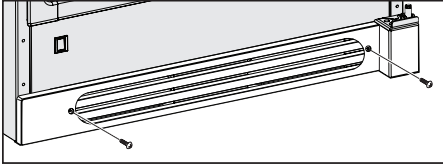

Kick Plate Removal

Leveling

The refrigerator must have all bottom corners resting firmly on a solid floor.

The floor must be strong enough to support a fully loaded refrigerator.

It is VERY IMPORTANT for your refrigerator to be level in order to function properly. If the refrigerator is not leveled during installation, the door may be misaligned and not close or seal properly, causing cooling, frost or moisture problems.

To Level the Refrigerator:

While unit is lying on its back, note the location of the four (4) leg levelers installed at each corner. These leg levelers will be used to level the refrigerator and to adjust the height. Use a carpenter's level to level the refrigerator from front to back and side to side. Adjust the plastic leveling feet in front, 1/2 bubble higher, so that the door closes easily when left halfway open.

Leveling Instructions for Matching Refrigerator / Freezer Pair:

- Level door of first unit using all four levelers and slide unit into place. Recheck for levelness and adjust if necessary.
- Measure distance from floor to bottom of door on first unit. Adjust and level second unit so door height matches.

Leg Level Adjustments:

- One full turn of all four leg levelers will raise door 5/32".
- Slide second unit into place leaving a minimum gap of 3/16" between units for door swing clearance.

- This last step may require at least one extraction of the second unit to properly align units in a "built-in" application.

Leveling Door with Adjustable Hinge

Use the lower hinge adjustment to fine tune the door height and for final cabinet spacing. Use a 7/16" socket or wrench to adjust the screw at the bottom of the lower hinge.

Adjusting Doors for Matching Refrigerator / Freezer Pair

The doors may also be adjusted side to side with the slotted hinge for aligning the doors parallel to each other. Loosen the two bolts with a 3/8" wrench and one screw with a Phillips screwdriver. Shift the doors until parallel, then retighten the screw and bolts securely. (See illustration below.)

Lower Hinge Adjustment for Leveling the Doors of the Matching Refrigerator / Freezer Pair

To level the doors using the adjustable lower hinge (some models):

1. If the refrigerator door is lower than the freezer door, raise the refrigerator door by turning the adjustment screw clockwise using a 7/16" socket wrench. (See illustration below.)
2. If the freezer door is lower than the refrigerator door, raise the freezer door by turning the adjustment screw clockwise using a 7/16" socket wrench. (See illustration below.)

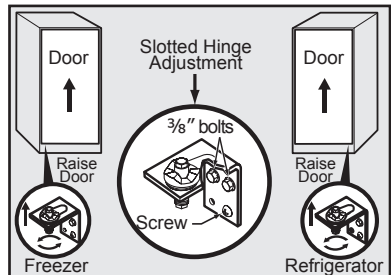

DOOR REMOVAL

If door must be removed:

- Unplug the unit or switch the breaker that supplies power to the unit to the off position.
- Remove the plastic top hinge cover.
- Hold the door in place while removing the top hinge from the cabinet.
- Remove the two $\frac{3}{8}$ " hex head bolts from the top hinge with a $\frac{3}{8}$ " wrench or socket.
- Lift the door upwards and pull up and away from the cabinet until free of the bottom hinge pin mounted on the front of the cabinet.
- To replace the door, reverse the above procedures and securely tighten all screws to prevent hinge slippage.



CAUTION

Doors are heavy. Two people are recommended to remove or replace the door assembly from the cabinet.

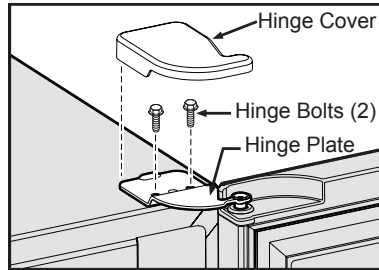

ELECTRONIC CONTROL

Setting the PRO-SELECT™ Electronic Control

Cool Down Period

For safe food storage, allow 4 hours for refrigerator to cool down completely. The refrigerator will run continuously for the first several hours.

Pro-Select™ Electronic Control

The Pro-Select™ Electronic Control is located inside the refrigerator. Temperature is factory preset to provide satisfactory food storage temperatures. However, the temperature control is adjustable to provide a range of temperatures for your personal satisfaction.

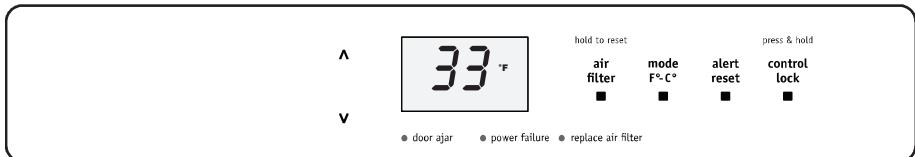

To adjust the temperature setting, press the UP (^) key for warmer temperature and DOWN (v) key for colder temperature on the control panel. Allow several hours for the temperature to stabilize between adjustments. The refrigerator can be adjusted between 33°F (1°C) and 46°F (8°C). By pressing the TEMP MODE key, the temperature display will toggle between °F and °C.

To turn the refrigerator OFF, press the UP (▲) key until the warmest temperature setting of 46°F (8°C) shows in the display. Then press the UP (▲) key 3 times within 3 seconds to turn the refrigerator OFF. The display will then show "OF". To turn the unit back ON, press the DOWN (▼) key 3 times within 3 seconds. The control will then display "46°F (8°C)" and may be adjusted to the desired temperature.

PRO-SELECT™ Electronic Control Features

Replace Air Filter

When the "REPLACE AIR FILTER" LED is illuminated yellow, the air filter needs to be replaced. The control will signal for air filter replacement after 3600 hours of refrigerator operation. After replacing the air filter, reset the air filter timer by pressing the AIR FILTER key for 3 seconds. The "REPLACE AIR FILTER" LED will be illuminated green for 3 seconds, confirming a timer reset.

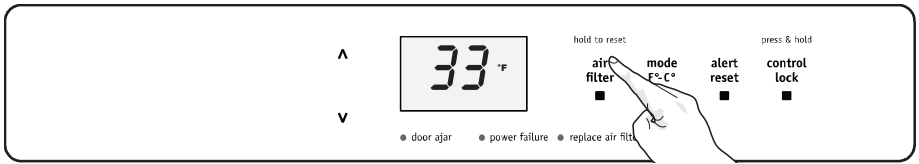

Control Lock

To disable the keypads on the control, begin by pressing the CONTROL LOCK key for 3 seconds until "LO" is displayed for 1 second. With the control locked, when keys are pressed on the control panel, "LO" will be displayed. To unlock the control, press the CONTROL LOCK key for 3 seconds. The display will show "UL" for one second.

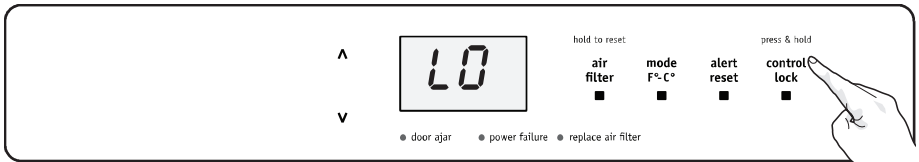

Power Fail

The POWER FAIL indicator light informs you that due to a power failure, the cabinet temperature exceeded 55°F (13°C). If the power failure lasted more than 1 hour, the display alternates between showing the power failure duration (Hours and DURATION LED illuminate in the display) and the cabinet temperature (°F or °C illuminates) every ½ second. This safety feature will aid in determining what food spoilage action to take.

The Power Fail indicator light and duration display can be turned off by pressing Alert Reset.

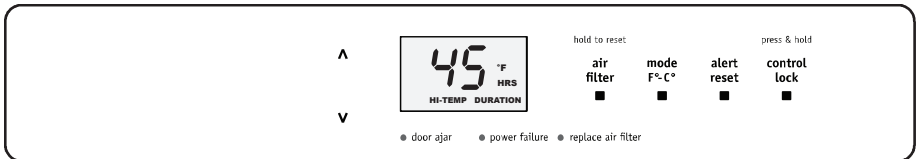

SABBATH MODE

The Sabbath mode is a feature that disables portions of the refrigerator and its controls in accordance with observance of the weekly Sabbath and religious holidays within the Orthodox Jewish community.

To initiate or exit Sabbath Mode, press and hold the CONTROL LOCK and TEMP MODE keys for 3 seconds. Then "Sb" will be displayed on the control panel indicating that the unit is in Sabbath mode.

In the Sabbath mode, the High Temp alarm is active for health reasons. If a high temperature alarm is activated during this time, for example due to a door left ajar, the alarm will sound for about 10 minutes. The alarm will then silence on its own and a "high temp" icon will be displayed on the control panel. The high temp icon will continue to display even if the door is closed until Sabbath mode is exited and the icon reset.



For further assistance, guidelines of proper usage and a complete list of models with the Sabbath feature, please visit the web at <http://www.star-k.org>.

NOTE: While in Sabbath mode, neither the lights nor the control panel will work until Sabbath mode has been deactivated.

The unit stays in Sabbath mode after a power failure recovery. It must be deactivated with the buttons on the control panel.

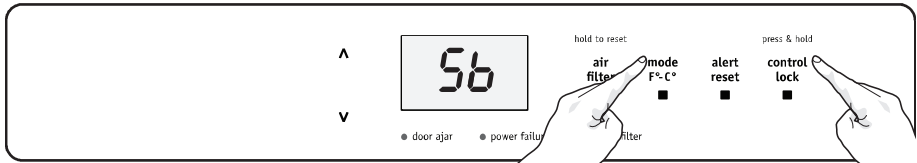

ALERTS

There are 4 possible conditions that will cause the alert tone to sound.

High Temp Alert

If the temperature inside the cabinet exceeds 55°F (13°C), the HIGH TEMP LED will illuminate, and after 1 hour, the HIGH TEMP Alarm will sound with 4 short beeps every ½ second, and the cabinet temperature is shown in the display. The LED and temperature alert will remain active until the cabinet temperature is below 55°F (13°C).

The audible alert can be turned off by pressing Alert RESET key.

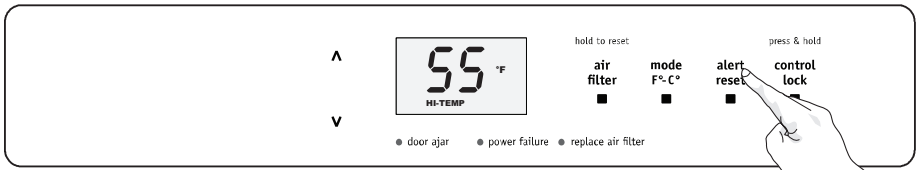

Door Ajar Alert

This alert will sound to alert you that the door has been open for 5 minutes or more. The DOOR AJAR LED will illuminate and the audible alert will sound until the door is closed.

The audible alert can be turned off by pressing the Alert RESET key or by closing the door. If the door is ajar for 15 minutes, the interior light will turn off.

Temp Error Alert

The sensor alert signals you that a problem exists with a temperature sensor. The audible alarm will sound after 1 hour and the display will alternate between "E8" or "E9" and 33°F (1°C) at ½ second intervals. The control will then enter a mode that runs the refrigerator in a manner that maintains the factory set cabinet temperature.

The audible alert can be turned off by pressing the Alert RESET key.

Stuck Key Alert

The stuck key alert will sound if the control reads a keypress for longer than 30 seconds. The audible alert will sound and will be limited to one minute and will stop automatically. The display will alternate between "E7" and 33°F (1°C) at ½ second intervals. The control will then enter a mode that runs the refrigerator in a manner that maintains the factory set cabinet temperature until the condition is resolved.

The audible alert can be turned off by pressing the Alert RESET key.

CHANGING THE FILTER

PURE ADVANTAGE™ Air Filter

Your new Pure Advantage air filter is located inside one of the 2-Liter Door Bins. The air filter cover is located on the upper right side of the control box. In general, you should change the air filter with Part Number "EAFCBF" every 6 months to ensure optimal filtering of freezer odors. The replacement air filter can be purchased on the Frigidaire website (<http://frigidaire.stores.yahoo.net>) or call toll free in the U.S. and Canada: 1-800-599-7569. Your electronic control is equipped with a Replace Air Filter indicator to remind you to change your filter.

To Install Or Replace The Air Filter

- Pull down on the front of the Pure Advantage™ air filter cover to release the hinged bottom cover.
- Allow bottom cover to swing open and then remove the old filter and discard it.
- Unpackage the new filter and place it inside the hinged bottom cover of the housing.
- Push the hinged bottom cover upward until the tab snaps into closed position.

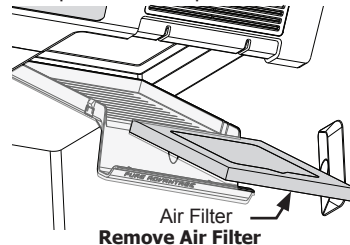
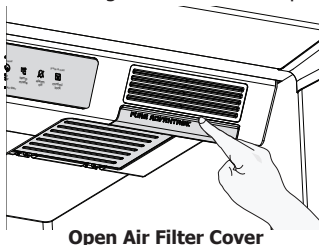

INTERIOR LIGHTING

Mid-Level Lighting (some models)

The mid level and upper level lighting comes on automatically when the door is opened.



IMPORTANT

To disconnect power to the unit, unplug the unit or switch the breaker that supplies power to the unit to the off position. Replace the old bulb with a bulb of the same wattage.

To replace the light bulbs:

1. To replace the light bulb, turn the temperature control to OFF and unplug the electrical cord.
2. Remove the lens from the lamp housing by unsnapping it from the lamp housing using your fingers or a screwdriver. Be careful not to break the locking tabs on the lamp housing.
3. Replace the old bulb with a bulb of the same type and wattage.
4. To replace the lens, snap one side of the lens opening to the tab on the lamp housing. Then carefully attach the other side.

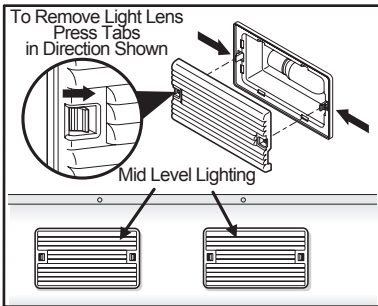

Mid-Level Lighting Light Bulb Removal

LED Lighting (some models)

To Replace LED Lights:

1. Unplug the power cord.
2. Remove light cover by pushing up and out.
3. Hold the LED cover with one hand and pull the connector with the other hand while pressing the connector latch.
4. Replace LED light and snap in place assuring the light is facing in toward the unit (inside fresh food).

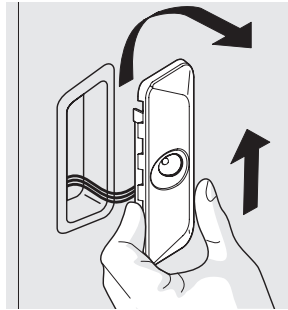

LED Light Removal

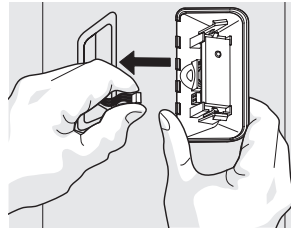

LED Light Harness Removal



NOTE

LED lights are in series, so if one is bad or unplugged, several lights may not light up.

Upper-Level Lighting (some models)

The upper level lighting comes on automatically when the door is opened.



IMPORTANT

To disconnect power to the unit, unplug the unit or switch the breaker that supplies power to the unit to the off position. Replace the old bulb with a bulb of the same wattage.

To replace the light bulbs:

1. To replace the light bulb, turn the temperature control to OFF and unplug the electrical cord.
2. Remove the light shield by pushing in on the sides where the two tabs are located in the back, then rotate the light shield down and out.
3. Replace the old bulb with a bulb of the same type and wattage.

4. When replacing the light shield, insert the three tabs in the front of the light shield into the slots in the control box and then rotate the rear upward until the two retaining latches lock into place.

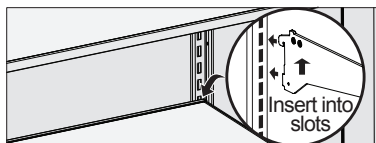
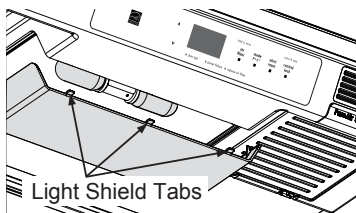
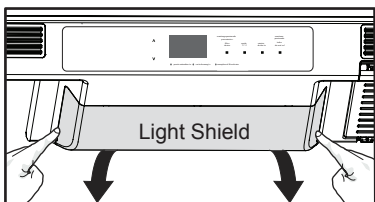

Deli Drawer

This model is equipped with a Deli Drawer for storage of luncheon meats, spreads, cheeses, and other deli items.

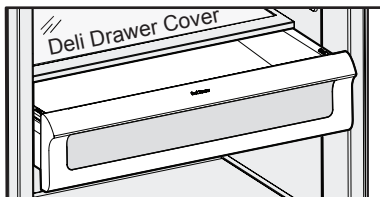

Crisper Drawer With Adjustable Dividers

The crisper drawer, located at the bottom of the refrigerator interior, is designed for storing fruits, vegetables, and other fresh produce. Wash items in clean water and then remove excess water before placing them in the crisper. Items with strong odors or high moisture content should be wrapped before storing. Dividers may be adjusted for different size items within the crisper.

To remove the Crisper Drawer or Deli Drawer:

1. Remove the glass cover from the drawer to be removed.
2. With both hands, lift up on the front of the drawer until it releases from the side supports.
3. Carefully remove the drawer from the refrigerator.

STORAGE FEATURES

SpaceWise™ Glass Shelves

Multi-position adjustable slide out glass shelves can be moved to any position for larger or smaller packages. The shipping spacers that stabilize the shelves for shipping may be removed and discarded.

To Adjust The Shelves

- Lift front edge up.
- Pull shelf out.
- Replace the shelf by inserting the hooks at rear of the shelf into the wall bracket. Lower the shelf into the desired slots and lock into position.

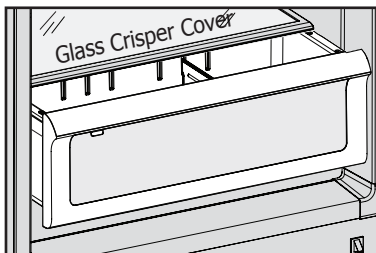
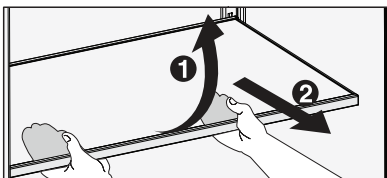

STORAGE FEATURES

NOTE

Leafy vegetables keep best when stored with the humidity control set on HIGH HUMIDITY, or in a drawer without a humidity control. This keeps incoming air to a minimum and maintains maximum moisture content.

Adjustable Two-Liter Door Bins

This model is equipped with adjustable door bins that can be moved to suit individual needs.

To Move Door Bins:

- Lift the bin straight up.
- Remove the bin.
- Place the bin in desired position.
- Lower the bin onto supports until locked in place.

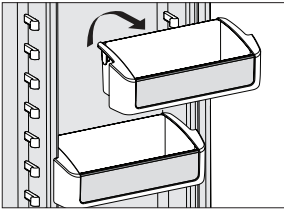

Dairy Bin

Use the dairy compartment, at the top of the fresh food compartment door, for short term storage of cheese, spreads, or butter. The dairy compartment is designed to be warmer than the open storage area to accommodate these types of food.

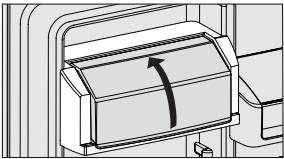

Full Width Gallon Bin

The full width gallon bin is especially designed to hold gallon-sized containers like milk gallons.

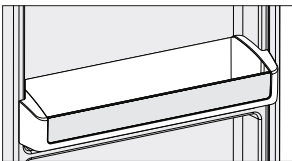

STORAGE FEATURES

Storing Foods

Fresh Food Storage

- Keep the fresh food compartment between 34°F and 40°F with an optimum temperature of 37°F.
- Avoid overcrowding the refrigerator shelves, which reduces air circulation and causes uneven cooling.

Fruits and Vegetables

- Store fruits and vegetables in crisper drawers, where trapped moisture helps preserve food quality for longer time periods.

Meat

- Wrap raw meat and poultry securely so leakage and contamination of other foods or surfaces does not occur.

ENERGY-SAVING TIPS



- Locate the appliance in the coolest part of the room, out of direct sunlight, and away from heating ducts or registers. Do not place the unit next to heat-producing appliances such as a range, oven, or dishwasher. If this is not possible, a section of cabinetry or an added layer of insulation between the two appliances will help the unit operate more efficiently.
- Level appliance so that the door closes tightly.
- Refer to the "SETTING THE TEMPERATURE CONTROL" section for the suggested temperature control settings.
- Do not overcrowd the unit or block cold air vents. Doing so causes the appliance to run longer and use more energy.
- Cover foods and wipe containers dry before placing them in the appliance. This cuts down on moisture build-up inside the unit.
- Organize the appliance to reduce door openings. Remove as many items as needed at one time and close the door as soon as possible.

Keep your refrigerator clean to prevent odor build-up. Wipe up any spills immediately and clean at least twice a year. Never use metallic scouring pads, brushes, abrasive cleaners or strong alkaline solutions on any surface. Do not wash any removable parts in a dishwasher. Always unplug the electrical power.



CAUTION

- **When moving the refrigerator, pull straight out. Do not shift the refrigerator from side to side as this may tear or gouge the floor covering.**
- **Damp objects stick to cold metal surfaces. Do not touch interior metal surfaces with wet or damp hands.**

Vacation and Moving Tips

Short Vacations:

- Leave the refrigerator operating during vacations of less than 3 weeks.

Long Vacations:

If the refrigerator will not be used for several months:

- Remove all food and unplug the power cord.
- Clean and dry the interior thoroughly.
- Leave the refrigerator door open slightly, blocking it open if necessary, to prevent odor and mold growth.

Moving: When moving the refrigerator, follow these guidelines to prevent damage:

- Disconnect the power cord plug from the wall outlet.
- Remove foods, then defrost, and clean the refrigerator.
- Secure all loose items such as base panel, baskets, and shelves by taping them securely in place to prevent damage.
- In the moving vehicle, secure refrigerator in an upright position to prevent movement. Also protect outside of refrigerator with a blanket, or similar item.

NOTE

- Turning the refrigerator temperature control to "OFF" (See Pro Select™ Electronic Control) turns off the compressor, but does not disconnect electrical power to the lights or other electrical components. Unplug the unit or switch the breaker that supplies power to the unit to the off position.
- Do not use razor blades or other sharp instruments which can scratch the appliance surface when removing adhesive labels. Any glue left from tape or labels can be removed with a mixture of warm water and mild detergent, or, touch the glue residue with the sticky side of tape you have already removed. Do not remove the serial plate.

CARE AND CLEANING

Care and Cleaning Chart

Part	Cleaning Agents	Tips and Precautions
Interior & Door Liners	<ul style="list-style-type: none"> • Soap and water • Baking soda and water 	<ul style="list-style-type: none"> • Use 2 tablespoons (25 g.) of baking soda in 1 quart (1 l) of warm water. • Be sure to wring excess water out of sponge or cloth before cleaning around controls, light bulb or any electrical part.
Door Gaskets	<ul style="list-style-type: none"> • Soap and water 	<ul style="list-style-type: none"> • Wipe gaskets with a clean soft cloth.
Drawers & Bins	<ul style="list-style-type: none"> • Soap and water 	<ul style="list-style-type: none"> • Use a soft cloth to clean drawer runners and tracks. • Do not wash any removable items (bins, drawers, etc.) in dishwasher.
Glass Shelves	<ul style="list-style-type: none"> • Soap and water • Glass cleaner • Mild liquid sprays 	<ul style="list-style-type: none"> • Allow glass to warm to room temperature before immersing in warm water.
Exterior & Handles	<ul style="list-style-type: none"> • Soap and water • Non-Abrasive Glass Cleaner 	<ul style="list-style-type: none"> • Do not use commercial household cleaners, ammonia, or alcohol to clean handles. • Use a soft cloth to clean smooth handles. • Do not use a dry cloth to clean smooth doors.
Exterior & Handles (Stainless Steel Models Only)	<ul style="list-style-type: none"> • Soap and water • Ammonia • Stainless Steel Cleaners 	<ul style="list-style-type: none"> • Never use CHLORIDE to clean stainless steel. • Clean stainless steel front and handles with non-abrasive soapy water and a dishcloth. Rinse with clean water and a soft cloth. • Wipe stubborn spots with an ammonia-soaked paper towel, and rinse. Use a non-abrasive stainless steel cleaner. These cleaners can be purchased at most home improvement or major department stores. Always follow manufacturer's instruction. • NOTE: Always, clean, wipe and dry with grain to prevent cross-grain scratching. • Wash the rest of the cabinet with warm water and mild liquid detergent. Rinse well, and wipe dry with a clean soft cloth.

BEFORE YOU CALL

1-800-944-9044 (United States)
1-800-265-8352 (Canada)

Visit our web site at
www.frigidaire.com.

Before calling for service, review this list. It may save you time and expense. This list includes common occurrences that are not the result of defective workmanship or materials in this appliance.

PROBLEM	CAUSE	CORRECTION
APPLIANCE OPERATION		
Appliance does not run.	<ul style="list-style-type: none"> • Appliance is plugged into a circuit that has a ground fault interrupt. • Temperature Control is in the OFF position. • Appliance may not be plugged in or plug is loose. • House fuse blown or tripped circuit breaker. • Power outage. 	<ul style="list-style-type: none"> • Use another circuit. If you are unsure about the outlet, have it checked by a certified technician. • See ELECTRONIC CONTROL section. • Ensure plug is tightly pushed into outlet. • Check/replace fuse with a 15-amp time-delay fuse. Reset circuit breaker. • Check house lights. Call local electric company.
Appliance runs too much or too long.	<ul style="list-style-type: none"> • Room or outside weather is hot. • Appliance has recently been disconnected for a period of time. • Large amounts of warm or hot food have been stored recently. • Door is opened too frequently or too long. • Door may be slightly open. • Temperature control is set too low. • Gaskets are dirty, worn, cracked, or poorly fitted. 	<ul style="list-style-type: none"> • It's normal for the appliance to work longer under these conditions. • It takes 24 hours for the appliance to cool down completely. • Warm food will cause appliance to run more until the desired temperature is reached. • Warm air entering the appliance causes it to run more. Open door less often. • See "DOOR PROBLEMS". • Turn control knob to a warmer setting. Allow several hours for the temperature to stabilize. • Clean or change gasket. Leaks in door seal will cause appliance to run longer in order to maintain desired temperatures.
APPLIANCE TEMPERATURES		
Interior appliance temperature is too cold.	<ul style="list-style-type: none"> • Temperature control is set too low. 	<ul style="list-style-type: none"> • Set control to a warmer setting. Allow several hours for temperature to stabilize.
Temperature inside appliance is too warm.	<ul style="list-style-type: none"> • Temperature control is set too warm. • Door is opened too frequently or too long. • Door may not be seating properly. • Large amount of warm or hot food has been stored recently. • Appliance has recently been disconnected for a period of time. 	<ul style="list-style-type: none"> • Turn control to a colder setting. Allow several hours for temperature to stabilize. • Warm air enters the appliance every time the door is opened. Open door less often. • See "DOOR PROBLEMS". • Wait until the appliance has had a chance to reach its selected temperature. • Appliance requires 24 hours to cool down completely.
"LO" is displayed on control.	<ul style="list-style-type: none"> • Control has been locked. 	<ul style="list-style-type: none"> • Press the CONTROL LOCK key for three seconds to unlock.

BEFORE YOU CALL

PROBLEM	CAUSE	CORRECTION
"E7", "E8", "E9" is displayed on control.	<ul style="list-style-type: none"> The control has registered an error code. 	<ul style="list-style-type: none"> For toll-free telephone support in the U.S. and Canada: 1-800-374-4432
"Sb" is displayed on control.	<ul style="list-style-type: none"> The control is in Sabbath Mode. 	<ul style="list-style-type: none"> Pressing the CONTROL LOCK and TEMP MODE keys to exit Sabbath Mode.
SOUND AND NOISE		
Louder sound levels whenever appliance is on.	<ul style="list-style-type: none"> Appliance operates at higher pressures during the start of the ON cycle. 	<ul style="list-style-type: none"> This is normal. Sound will level off or disappear as appliance continues to run.
Popping or cracking sound when compressor comes on. Bubbling or gurgling sound.	<ul style="list-style-type: none"> Metal parts undergo expansion and contraction, as in hot water pipes. Refrigerant (used to cool refrigerator) is circulating throughout the system. 	<ul style="list-style-type: none"> This is normal. Sound will level off or disappear as appliance continues to run. This is normal.
Vibrating or rattling noise.	<ul style="list-style-type: none"> Appliance is not level. It rocks on the floor when it is moved slightly. Floor is uneven or weak. Appliance is touching the wall. 	<ul style="list-style-type: none"> Level the appliance. Refer to "Leveling" section. Ensure floor can adequately support the appliance. Level the appliance by putting wood or metal shims under part of the appliance. Re-level appliance or move appliance slightly. Refer to "Leveling" in the INSTALLATION section.
WATER / MOISTURE / FROST INSIDE APPLIANCE		
Moisture forms on inside appliance walls.	<ul style="list-style-type: none"> Weather is hot and humid, which increases internal rate of frost buildup. Door is slightly open. Door is kept open too long. 	<ul style="list-style-type: none"> This is normal. See "DOOR PROBLEMS". Open the door less often.
ODOR IN APPLIANCE		
Odors in appliance.	<ul style="list-style-type: none"> Interior needs to be cleaned. Foods with strong odors are in the appliance. 	<ul style="list-style-type: none"> Clean interior with sponge, warm water, and baking soda. Replace air filter. Cover the food tightly.
DOOR PROBLEMS		
Door will not close.	<ul style="list-style-type: none"> Appliance is not level. It rocks on the floor when it is moved slightly. Floor is uneven or weak. 	<ul style="list-style-type: none"> This condition can force the cabinet out of square and misalign the door. Refer to "Leveling" section. Ensure floor can adequately support appliance. Level the appliance by putting wood or metal shims under part of the appliance.
LIGHTING PROBLEMS		
Light bulb is not on.	<ul style="list-style-type: none"> The light bulb is burned out. No electric current is reaching the appliance. Control is in Sabbath mode (Sb is displayed on control). 	<ul style="list-style-type: none"> Follow directions under INTERIOR LIGHTING section. See "Appliance does not run". Depress TEMP MODE key and CONTROL LOCK key for 3 seconds.

MAJOR APPLIANCE WARRANTY

Your appliance is covered by a one year limited warranty. For one year from your original date of purchase, Electrolux will pay all costs for repairing or replacing any parts of this appliance that prove to be defective in materials or workmanship when such appliance is installed, used and maintained in accordance with the provided instructions.

Exclusions

This warranty does not cover the following:

1. Products with original serial numbers that have been removed, altered or cannot be readily determined.
2. Product that has been transferred from its original owner to another party or removed outside the USA or Canada.
3. Rust on the interior or exterior of the unit.
4. Products purchased "as-is" are not covered by this warranty.
5. Food loss due to any refrigerator or freezer failures.
6. Products used in a commercial setting.
7. Service calls which do not involve malfunction or defects in materials or workmanship, or for appliances not in ordinary household use or used other than in accordance with the provided instructions.
8. Service calls to correct the installation of your appliance or to instruct you how to use your appliance.
9. Expenses for making the appliance accessible for servicing, such as removal of trim, cupboards, shelves, etc., which are not a part of the appliance when it is shipped from the factory.
10. Service calls to repair or replace appliance light bulbs, air filters, water filters, other consumables, or knobs, handles, or other cosmetic parts.
11. Surcharges including, but not limited to, any after hour, weekend, or holiday service calls, tolls, ferry trip charges, or mileage expense for service calls to remote areas, including the state of Alaska.
12. Damages to the finish of appliance or home incurred during installation, including but not limited to floors, cabinets, walls, etc.
13. Damages caused by: services performed by unauthorized service companies; use of parts other than genuine Electrolux parts or parts obtained from persons other than authorized service companies; or external causes such as abuse, misuse, inadequate power supply, accidents, fires, or acts of God.

DISCLAIMER OF IMPLIED WARRANTIES; LIMITATION OF REMEDIES

CUSTOMER'S SOLE AND EXCLUSIVE REMEDY UNDER THIS LIMITED WARRANTY SHALL BE PRODUCT REPAIR OR REPLACEMENT AS PROVIDED HEREIN. CLAIMS BASED ON IMPLIED WARRANTIES, INCLUDING WARRANTIES OF MERCHANTABILITY OR FITNESS FOR A PARTICULAR PURPOSE, ARE LIMITED TO ONE YEAR OR THE SHORTEST PERIOD ALLOWED BY LAW, BUT NOT LESS THAN ONE YEAR. ELECTROLUX SHALL NOT BE LIABLE FOR CONSEQUENTIAL OR INCIDENTAL DAMAGES SUCH AS PROPERTY DAMAGE AND INCIDENTAL EXPENSES RESULTING FROM ANY BREACH OF THIS WRITTEN LIMITED WARRANTY OR ANY IMPLIED WARRANTY. SOME STATES AND PROVINCES DO NOT ALLOW THE EXCLUSION OR LIMITATION OF INCIDENTAL OR CONSEQUENTIAL DAMAGES, OR LIMITATIONS ON THE DURATION OF IMPLIED WARRANTIES, SO THESE LIMITATIONS OR EXCLUSIONS MAY NOT APPLY TO YOU. THIS WRITTEN WARRANTY GIVES YOU SPECIFIC LEGAL RIGHTS. YOU MAY ALSO HAVE OTHER RIGHTS THAT VARY FROM STATE TO STATE.

If You Need Service

Keep your receipt, delivery slip, or some other appropriate payment record to establish the warranty period should service be required. If service is performed, it is in your best interest to obtain and keep all receipts. Service under this warranty must be obtained by contacting Electrolux at the addresses or phone numbers below.

This warranty only applies in the USA and Canada. In the USA, your appliance is warranted by Electrolux Major Appliances North America, a division of Electrolux Home Products, Inc. In Canada, your appliance is warranted by Electrolux Canada Corp. Electrolux authorizes no person to change or add to any obligations under this warranty. Obligations for service and parts under this warranty must be performed by Electrolux or an authorized service company. Product features or specifications as described or illustrated are subject to change without notice.

USA

1.800.944.9044

Frigidaire
10200 David Taylor Drive
Charlotte, NC 28262



Electrolux

Canada

1.800.265.8352

Electrolux Canada Corp.
5855 Terry Fox Way
Mississauga, Ontario, Canada
L5V 3E4