

Use & Care Manual

Gas ***Cooktop***

CONTENTS

Page

Versión en español	2
Product Registration	2
Important Safety Instructions	3-4
Grounding Instructions	4
Liquefied Petroleum (Propane) Gas Conversion	5
Flame Size	5
Proper Burner Adjustment	5
Setting Surface Control	
Venturi (open) Burner Models	6
Sealed Burner Models	6
Electric Ignition	6
Selecting Surface Cooking Utensils	7
Specialty Pans & Trivets	7
Canning Tips & Information	8
General Cleaning	
Cleaning Various Parts of your Cooktop	9
Venturi (open) Burner Models	10
Sealed Burner Models	11-14
Avoid Service Checklist	15
Warranty	16

Visit the Frigidaire Web Site at:
<http://www.frigidaire.com>

Product Registration

Register Your Product

The **PRODUCT REGISTRATION CARD** should be filled in completely, signed and returned to Electrolux Home Products North America.

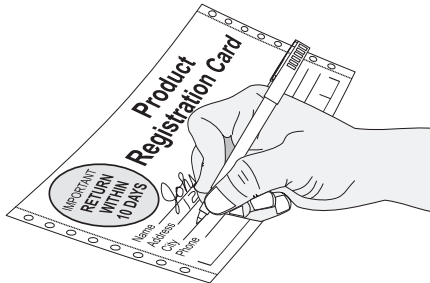

Versión en español

Si desea obtener una copia en español de este Manual del Usuario, sírvase escribir a la dirección que se incluye a continuación. Solicite la P/N **318204005**.

Electrolux Home Products
Attn : Care Use
P.O. Box 212378
Augusta, GA 30917

Thank you for choosing this appliance. The information contained within this **Owner's Guide** will instruct you on how to properly operate and care for your cooktop. Please read through the information contained in your literature pack to learn more about your new appliance.

Record Your Model and Serial Numbers

Record in the space provided below the model and serial numbers found underneath or inside the cooktop.

Model Number: _____

Serial Number: _____

Date of Purchase: _____

This Owner's Guide contains general operating instructions for your cooktop and feature information for several models. Your cooktop **may not** have all the described features.

Note: The instructions appearing in this Owner's Guide are not meant to cover every possible condition and situation that may occur. Common sense and caution must be practiced when installing, operating and maintaining any appliance.



⚠ WARNING If the information in this manual is not followed exactly, a fire or explosion may result causing property damage, personal injury or death.

FOR YOUR SAFETY:

- Do not store or use gasoline or other flammable vapors and liquids in the vicinity of this or any other appliance.
- **WHAT TO DO IF YOU SMELL GAS:**
 - Do not try to light any appliance.
 - Do not touch any electrical switch; do not use any phone in your building.
 - Immediately call your gas supplier from a neighbor's phone. Follow the gas supplier's instructions.
 - If you cannot reach your gas supplier, call the fire department.
- Installation and service must be performed by a qualified installer, servicer or the gas supplier.

IMPORTANT SAFETY INSTRUCTIONS

Read all instructions before using this appliance.
Save these instructions for future reference.

This guide contains important safety symbols and instructions. Please pay special attention to these symbols and follow all instructions given. Here is a brief explanation of the use of these symbols.

⚠ WARNING This symbol will help alert you to situations that may cause serious bodily harm, death or property damage.

⚠ CAUTION This symbol will help alert you to situations that may cause bodily injury or property damage.

- **Remove all tape and packaging wrap before using the cooktop. Destroy the carton and plastic bags after unpacking the cooktop.** Never allow children to play with packaging material. Do not remove the model/serial plate attached to the cooktop.
- **Proper Installation—Be sure your appliance is properly installed and grounded by a qualified technician in accordance with the National Fuel Gas Code ANSI Z223.1 latest edition in the United States, or in Canada CAN/CGA B149.1, and CAN/CGA B149.2, and the National Electrical Code ANSI/NFPA No. 70—latest edition in United States, or in Canada CSA Standard C22.1, Canadian Electrical Code, Part 1, and local code requirements.** Install and/or adjust only per installation instructions provided in the literature package for this cooktop.

Ask your dealer to recommend a qualified technician and an authorized repair service. Know how to shut off gas supply at the meter and disconnect the electrical power to the cooktop at the circuit breaker or fuse box in case of an emergency.

- **User Servicing—Do not repair or replace any part of the appliance unless specifically recommended in the manuals.** All other servicing should be done only by a qualified technician. This may reduce the risk of personal injury and damage to the cooktop.
- **Never modify or alter the construction of a cooktop by removing panels, wire covers, or any other part of the product.**

⚠ WARNING Stepping or leaning on this cooktop can result in serious injuries and may also cause damage to the cooktop. Do not allow children to climb or play around the cooktop.

- **Storage on Appliance—Flammable materials should not be stored on the cooktop, near surface burners.** This includes paper, plastic and cloth items, such as cookbooks, plasticware and towels, as well as flammable liquids. Do not store explosives, such as aerosol cans, on the cooktop. Flammable materials may explode and result in fire or property damage.

⚠ CAUTION Do not store items of interest to children in the cabinets above the cooktop.

- **Do not leave children alone—Children should not be left alone or unattended in the area where an appliance is in use.** They should never be allowed to sit or stand on any part of the appliance.
- **DO NOT TOUCH SURFACE BURNERS, GRATES, OR AREAS NEAR THESE BURNERS.** Surface burners may be hot even though the flames are not visible. Areas near surface burners may become hot enough to cause burns. During and after use, do not touch or let clothing or other flammable materials touch these areas until they have had sufficient time to cool. Among these areas are the cooktop and the surfaces facing the cooktop.

- **Wear Proper Apparel—Loose-fitting or hanging garments should never be worn while using the appliance.** Do not let clothing or other flammable materials contact hot surfaces.

⚠ WARNING NEVER use this appliance as a space heater to heat or warm the room. Doing so may result in carbon monoxide poisoning.

- **Do Not Use Water or Flour on Grease Fires—Smother the fire with a pan lid, or use baking soda, a dry chemical or foam-type extinguisher.**
- **When heating fat or grease, watch it closely.** Fat or grease may catch fire if allowed to become too hot.
- **Use Only Dry Pot holders—Moist or damp pot holders on hot surfaces may result in burns from steam.** Do not let the pot holders touch the flame or burners. Do not use a towel or other bulky cloth instead of a pot holder.
- **Do Not Heat Unopened Food Containers—Buildup of pressure may cause container to burst and result in injury.**
- **Know which knob controls each surface burner.** Always turn the knob to the LITE position when igniting the burners. Visually check that the burner has lit. Then adjust the flame so it does not extend beyond the edge of the utensil.

⚠ WARNING Use Proper Flame Size—Adjust flame size so it does not extend beyond the edge of the utensil. The use of undersized utensils will expose a portion of the burner flame to direct contact and may result in ignition of clothing. Proper relationship of utensil to flame will also improve efficiency.

⚠ WARNING Do not use stove top grills on your sealed gas burners. If you use a stove top grill on a sealed gas burner, it will cause incomplete combustion and can result in exposure to carbon monoxide levels above allowable current standards. This can be hazardous to your health.

- **Use proper pan size—**This appliance is equipped with one or more surface burners of different sizes. Select utensils having flat bottom large enough to cover the surface burner. The use of undersized utensils will expose a portion of the surface burner to direct contact and may result in ignition of clothing. Proper relationship of utensil to the surface burner will also improve efficiency.
- **Utensil Handles Should Be Turned Inward and Not Extend Over Adjacent Surface Burners—**To reduce the risk of burns, ignition of flammable materials, and spillage due to unintentional contact with the utensil, the handle of the utensil should be positioned so that it is turned inward, and does not extend over adjacent surface burners.

IMPORTANT SAFETY INSTRUCTIONS (continued)

- **Never Leave Surface Burners Unattended at High Heat Settings**—Boilovers cause smoking and greasy spillovers that may ignite, or a pan that has boiled dry may melt.
- **Protective Liners**—Do not use aluminum foil to line surface burner pans. Protective liners or aluminum foil may interfere with heat and air distribution, and combustion. Damage to the cooktop or personal injury may result.
- **Glazed Cooking Utensils**—Only certain types of glass, glass/ceramic, ceramic, earthenware, or other glazed utensils are suitable for cooktop service without breaking due to the sudden change in temperature. Check the manufacturer's recommendations for cooktop use.
- **Do Not Use Decorative Surface Burner Covers.** If a burner is accidentally turned on, the decorative cover will become hot and possibly melt. You will not be able to see that the burner is on. Burns will occur if the hot covers are touched. Damage may also be done to the cooktop or burners because the covers may cause overheating. Air will be blocked from the burner and cause combustion problems.

GLASS COOKTOPS (some models):

- **Do Not Operate or Clean a Broken Cooktop Glass**—If glass top should break, cleaning solutions and spillovers may penetrate the broken cooktop and create a risk of electric shock. Contact a qualified technician immediately.
- **Clean Cooktop Glass with Caution**—If a wet sponge or cloth is used to wipe spills on a hot cooking area, be careful to avoid a steam burn. Some cleaners can produce harmful fumes if applied to a hot surface.
- **Avoid scratching the cooktop glass with sharp objects.**

IMPORTANT SAFETY NOTICE

The California Safe Drinking Water and Toxic Enforcement Act requires the Governor of California to publish a list of substances known to the state to cause cancer, birth defects or other reproductive harm, and requires businesses to warn customers of potential exposure to such substances.

SAVE THESE INSTRUCTIONS

Grounding Instructions (electric ignition models only)

IMPORTANT: READ AND SAVE THESE INSTRUCTIONS.

⚠ WARNING This appliance is equipped with a 3 prong grounding plug for your protection against shock hazard and should be plugged directly into a properly grounded receptacle. **DO NOT** cut or remove the grounding prong from this plug.

For personal safety, this cooktop must be properly grounded. For maximum safety, the power cord must be plugged into a 120V—60 Hz. outlet that is correctly polarized and properly grounded.

If a two-prong wall receptacle is the only available outlet, it is the personal responsibility of the consumer to have it replaced with a properly grounded three-prong wall receptacle installed by a qualified electrician.

DO NOT UNDER ANY CIRCUMSTANCES CUT OR REMOVE THE THIRD ROUND GROUNDING PRONG FROM THE POWER CORD PLUG. SEE THE INSTALLATION INSTRUCTIONS PACKAGED WITH THIS COOKTOP FOR COMPLETE INSTALLATION AND GROUNDING INSTRUCTIONS. DO NOT OPERATE THE COOKTOP USING A TWO-PRONG ADAPTER OR AN EXTENSION CORD.

⚠ WARNING Avoid fire hazard or electrical shock. Do not use an adaptor plug, an extension cord, or remove grounding prong from electrical power cord. Failure to follow this warning can cause serious injury, fire or death.

Grounding type wall receptacle

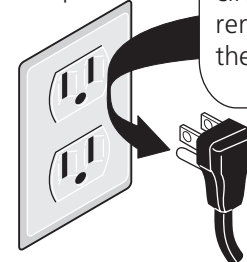

Power supply cord with 3-prong grounding plug

Liquefied Petroleum (Propane) Gas Conversion

⚠ WARNING Severe shock or damage to the cooktop may occur if the cooktop is not installed by a qualified installer or electrician.

This appliance can be used with Natural Gas and Propane Gas. It is shipped from the factory for use with natural gas.

If you wish to convert your cooktop for use with Liquefied Petroleum (propane) gas:

- Models with **Venturi (open) Burners**, see the installation instructions guide for the conversion instructions.
- Models with **Sealed Burners**:
 - **For some of them**, you should order the conversion kit from your local dealer or from an authorized service agency (see Warranty). See the installation instructions for the conversion kit number.
 - **For others**, the conversion kit is included in the packaging, if you wish to convert your cooktop for use with propane gas, use the supplied fixed orifices located in the package containing the installation instruction, in a bag marked "FOR LP/PROPANE GAS CONVERSION". Follow the instructions packaged with the orifices (for models with sealed burners only).

The conversion must be performed by a qualified service technician in accordance with the manufacturer's instructions and all codes and requirements of the authority having jurisdiction. Failure to follow the instructions could result in serious injury or property damage. The qualified agency performing this work assumes responsibility for the conversion.

Flame Size

For most cooking, start on the highest control setting and then turn to a lower one to complete the process. Use the chart below as a guide for determining proper flame size for various types of cooking. The size and type of utensil used and the amount of food being cooked will influence the setting needed for cooking.

For deep fat frying, use a thermometer and adjust the surface control knob accordingly. If the fat is too cool, the food will absorb the fat and be greasy. If the fat is too hot, the food will brown so quickly that the center will be undercooked. Do not attempt to deep fat fry too much food at once as the food will neither brown nor cook properly.

*Flame size	Type of Cooking
High Flame	Start most foods; bring water to a boil; pan broiling.
Medium Flame	Maintain a slow boil; thicken sauces, gravies; steam.
Low Flame	Keep foods cooking; poach; stew.

*** These settings are based on using medium-weight aluminum pans with lids. Settings may vary when using other types of pans.**

Never extend the flame beyond the outer edge of the utensil. A higher flame simply wastes heat and energy, and increases your risk of being burned by the flame.

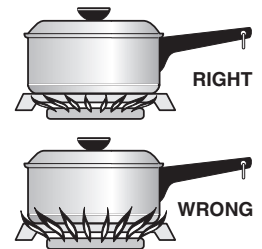

Proper Burner Adjustments

The color of the flame is the key to proper burner adjustment. A good flame is clear, blue and hardly visible in a well-lighted room. Each cone of flame should be steady and sharply defined. Adjust or clean burner if flame is yellow-orange. To clean burner, see instructions under **General Cleaning**.

Setting Surface Controls

The surface control knobs shown below may not look identical to the Surface Controls Knobs on your range; They are only representational.

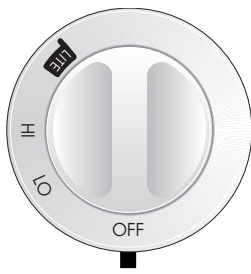
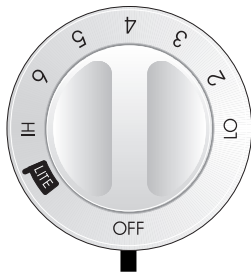

Venturi (opened) Burner Models

To Adjust Low or "Simmer" Setting (some models)

The burner flame, at low setting, can be adjusted if it is too high or too low; refer to the installation instruction for adjustment procedure.

To Adjust Standing Pilot Model (some models)

Each burner lights automatically either an electric or a standing pilot, depending on your model. Standing pilots must be lit initially. To light the standing pilot, open gas supply on pilot shutoff valves (screw), lift the cooktop from the front edge and hold a match near the pilot. *Standing pilots* will remain lit when the burners are turned off; because of that, the porcelain enamel cooktop can be hot even if burners are not used; refer to Installation Instructions for proper pilot adjustment. Models with *electric ignitors* light automatically each time a control knob is turned to the LITE position.

To operate the Surface Burner:

1. Place cooking utensil on burner.
2. Push in and turn the Surface Control knob to LITE. **Note:** All electronic ignitors will click at the same time. However, only the burner you are turning on will ignite.
3. Visually check that the burner has lit.
4. After the burner lights, turn the control knob to the desired flame size. The control knobs do not have to be set at a particular mark. Use the guides and adjust the flame as needed. **DO NOT** cook with the control knob in the LITE position. (The electronic ignitor will continue to click if left in the LITE position.)

Sealed Burner Models

Your appliance may be equipped with any combination of the following burners:

Simmer Burner, this burner is best used for simmering delicate sauces, etc.

Standard Burner, can be used for most all surface cooking needs.

Large Burner, the larger burner is best used when bringing large quantities of liquid to temperature and when preparing larger quantities of food.

Regardless of size, always select a utensil that is suitable for the amount and type of food being prepared. Select a burner and flame size appropriate to the pan. Never allow flames to extend beyond the outer edge of the pan.

Each burner lights automatically from an electric ignitor each time a control knob is turned to the lite position.

To operate the surface burner:

1. Place cooking utensil on burner.
2. **Push in and turn** the Surface Control knob to LITE. **Note:** All electronic ignitors will click at the same time. However, only the burner you are turning on will ignite.
3. Visually check that the burner has lit.
4. After the burner lights, turn the control knob to the desired flame size. The control knobs do not have to be set at a particular mark. Use the guides and adjust the flame as needed. **DO NOT** cook with the control knob in the LITE position. (The electronic ignitor will continue to click if left in the LITE position.)
5. To turn the burner off, turn the control knob as far as it will go, to the OFF position.

The surface control knobs shown below may not look identical to the Surface Controls Knobs on your range; They are only representational.

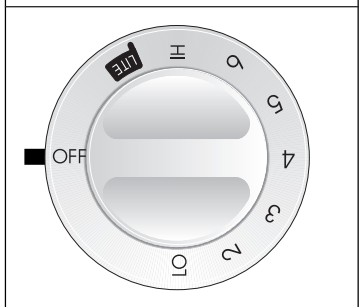

Electric Ignition Models

In the event of an electrical power outage, the surface burners can be lit manually. To light a surface burner, hold a lit match to the burner head, then slowly turn the surface control knob to LITE. Use caution when lighting surface burners manually.

Surface burner in use when an electrical power failure occurs will continue to operate normally.

CAUTION Do not operate the burner for an extended period of time without cookware on the grate. The finish on the grate may chip without cookware to absorb the heat.

CAUTION Do not place plastic items such as salt and pepper shakers, spoon holders or plastic wrappings on top of the cooktop when it is in use. These items could melt or ignite. Pot holders, towels or wood spoons could catch fire if placed too close to a flame.

Selecting Surface Cooking Utensils

For best results and energy conservation, choose cooking utensils that have these characteristics:

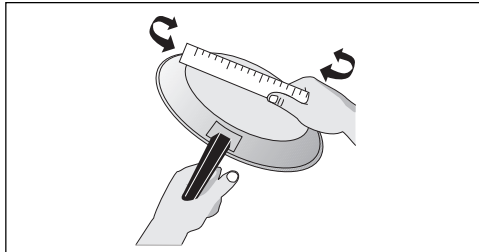

Pans should have flat bottoms. Check for flatness by rotating a ruler across the bottom. There should be no gaps between the pan and ruler.

Note: Always use a utensil for its intended purpose. Follow manufacturer's instructions. Some utensils were not made to be used in the oven or on the cooktop.

Note: Do not use griddle over more than one burner. That can damage your cooktop and that can result in exposure to carbon monoxide levels above allowable current standards. That can be hazardous to your health.

*GOOD

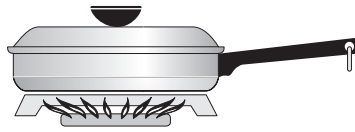

- **Flat bottom** and straight sides.
- Tight fitting lids.
- Weight of handle does not tilt pan. Pan is well balanced.
- Pan sizes match the amount of food to be prepared.
- Made of material that conducts heat well.
- Easy to clean.

POOR

- Curved and warped pan bottoms.

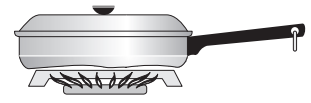

- Pan overhangs unit by more than 2.5 cm (1").

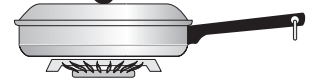

- Heavy handle tilts pan.



- Flame extends beyond unit.



* Specialty pans such as lobster pots, griddles and pressure cookers may be used but must conform to the above recommended cookware requirements.

Specialty Pans & Trivets



Woks with flat bottoms suitable for use on your cooktop are available in most cookshop or hardware stores. Round-bottomed woks (with a support ring that does not extend beyond the burner unit) may also be used. The metal ring was designed to support the wok safely when it is filled with large amounts of liquids (soup making) or fat (frying).

DO NOT use a wok if it is equipped with a metal ring that extends beyond the burner unit. Because this ring traps heat, the surface unit and cooktop surface could be damaged.

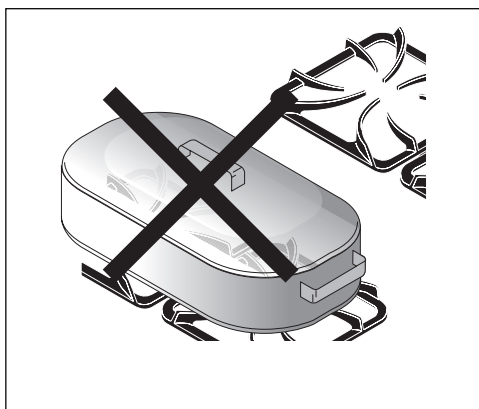

Wire trivets: Do not use wire trivets. Cookware bottoms must be in direct contact with the grates.

CAUTION DO NOT use two burner units to heat one large pan such as a roaster or griddle, or allow cooking utensils to boil dry. The bottom surface of the pan in either of these situations could cause discoloring or crazing of the appliance cooking surface, and damage to the grates and burner units.

Canning Tips & Information

⚠ CAUTION Canning can generate large amounts of steam. Use extreme caution to prevent burns. Always raise the lid to vent steam away from you.



1. Use tested recipes and follow instructions carefully. Check with your local Cooperative Agricultural Extension Service or a manufacturer of glass jars for the latest canning information.
2. Use flat-bottomed canners only. Heat is spread more evenly when the bottom surface is flat.
3. Center canner on the burner grate.
4. Start with hot water and a high heat setting to reduce the time it takes to bring the water to a boil; then reduce the heat setting as low as possible to maintain a constant boil.
5. It is best to can small amounts and light loads.

⚠ CAUTION Prevent damage to cooktop and burner grates:

1. Do not use water bath or pressure canners that extend more than one inch beyond the edge of the burner grate.
2. Do not leave water bath or pressure canners on high heat for an extended amount of time.
3. Alternate surface units between each batch to allow the units and surrounding surfaces to cool down. Try to avoid canning on the same burner unit all day.

⚠ CAUTION Safe canning requires that harmful micro-organisms are destroyed and the jars are sealed completely. When canning in a water bath canner, a gentle but steady boil must be maintained continuously for the required time.

General Cleaning

Cleaning Various Parts of Your Cooktop

Before cleaning any part of the cooktop, be sure all controls are turned OFF and the cooktop is COOL. Remove spillovers and heavy soiling as soon as possible. Regular cleaning will reduce the number of major cleaning later.

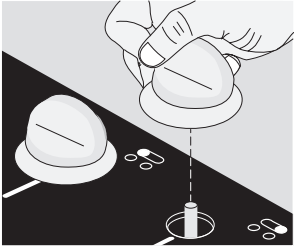
Surfaces	How to Clean
Aluminum (Trim Pieces) & Vinyl	Use hot, soapy water and a cloth. Dry with a clean cloth.
Glass, Painted and Plastic Control Knobs, Body Pieces, and Decorative Trim	<i>For general cleaning</i> , use hot soapy water and a cloth. <i>For more difficult soils and built-up grease</i> , apply a liquid detergent directly onto the soil. Leave on soil for 30 to 60 minutes. Rinse with a damp cloth and dry. DO NOT use abrasive cleaners on any of these materials; they can scratch.
Control Panel 	<i>Before cleaning the control panel</i> , turn all controls to OFF and remove the control knobs. To remove, pull each knob straight off the shaft. Clean using hot, soapy water and a cloth. Be sure to squeeze excess water from the cloth before wiping the panel; especially when wiping around the controls. Excess water in or around the controls may cause damage to the appliance. To replace knobs after cleaning, line up the flat sides of both the knob and the shaft; then push the knob into place.
Stainless Steel, Chrome Decorative Trim	Gentle scouring with a soapy nylon pad will remove most spots. Rinse with a 1:1 solution of clean water and ammonia. Cover difficult spots with an ammonia soaked paper towel for 30 minutes, scrub with a nylon pad and rinse with clean water. Cleaners made especially for stainless steel or chrome are recommended. Bluish stains on these materials are caused by overheating and cannot be removed. Remove all cleaners or the finish may be damaged during future heating. DO NOT use spray oven cleaners on the cooktop.
Porcelain Enamel Burner Grates, Burner Pans (some models), Burner Rings (some models), Cooktop Surface	Gentle scouring with a soapy nylon pad will remove most spots. Rinse with a 1:1 solution of clean water and ammonia. <i>If necessary</i> , cover difficult spots with an ammonia-soaked paper towel for 30 to 40 minutes. Rinse with clean water and damp cloth, then scrub with a soap-filled scoring pad. Rinse and wipe dry with a clean cloth. Remove all cleaners or the porcelain may become damaged during future heating. DO NOT use spray oven cleaners on the cooktop.
Surface Burners	<p>The holes in the burners of your cooktop must be kept clean at all times for proper ignition and a complete, even flame. Clean the burner holes routinely with a small gauge wire or needle and especially after bad spillovers which could clog these holes.</p> <p>To remove and replace burner units per your model, see instructions under General Cleaning. To clean, soak the burners in a 1:1 solution of ammonia and water for 30 to 40 minutes. For stubborn stains, scrub with soap and water or a mild abrasive cleanser and damp cloth. Dry the burners thoroughly in a warm oven for 30 minutes. Then replace them, making sure they are seated and level. DO NOT wash burner units in the dishwasher.</p>

General Cleaning (continued)

Venturi (open) Burner Models (some models)

To Raise and Lower the Top for Cleaning

The cooktop is hinged and can be raised to clean the area underneath. Be sure all cooktop controls are turned to OFF and burner grates are cool.

1. Remove controls knobs, burner grates and spillover bowls. Set aside.
2. Grasp the front of the cooktop and lift. Some models have a swing-up rod to support the cooktop in its raised position.
3. Clean under the cooktop.
4. Lower the top gently after lowering the support rod (some models).
5. Replace bowls, grates and control knobs.

⚠ WARNING When lowering the top, grasp the sides with fingertips only. Be careful not to pinch fingers. Also, **DO NOT** drop or bend the cooktop when raising or lowering. This could damage the surface.

⚠ WARNING **DO NOT** turn on the burners when the cooktop is raised for cleaning. Be sure that the top is completely lowered and securely in place before turning on the burners.

To Remove and Replace Burners

The burners on your cooktop maybe removed for cleaning. Be sure all controls are turned to OFF and burner grates are cool before removing cooktop burner units.

To Remove Burners

1. Remove the shipping screws from the support bracket. See illustrations for location of screws.
2. Grasp the burner head and tilt it to the right to release the tab from the burner support (A in Figure 1).
3. Lift the end of the burner assembly. Then pull away from the front of the cooktop to free the air shutter from the gas valve orifice (B in Figure 1).

If your cooktop is equipped with a standing gas pilot, use caution when removing burner. The flash tube may be hot because it is located near the pilot.

Check the lighter and burner ports (Figure 2). If they are clogged, use a wire or needle to clear them.

To remove burned-on food, soak the burners in a vinegar and water solution for 20-30 minutes. For stubborn stains, scrub with soap and water or a mild abrasive cleanser and a damp cloth. Do not wash burners in a dishwasher.

To Replace Burners

1. Slide the air shutter over the gas valve orifice (Figure 1).
2. Lower the burner assembly and hook the tab in the slots in the burner support. Make sure it is properly seated and level.
3. Be sure both tabs are in the correct slots, the burner sits level and straight, and the flash tube forms a straight line from the igniter to the burner (Figure 2).
4. Replace shipping screws if desired. These screws are not necessary for the operation of the burner. They stabilize the burner during shipping of the appliance. Retain the screws for later use in the event the range is moved.

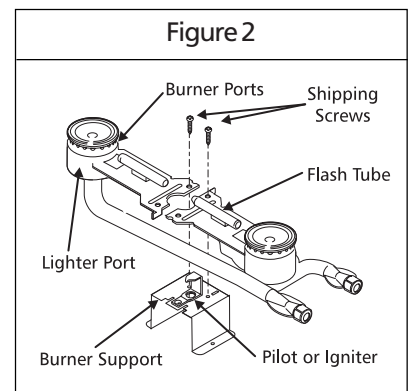
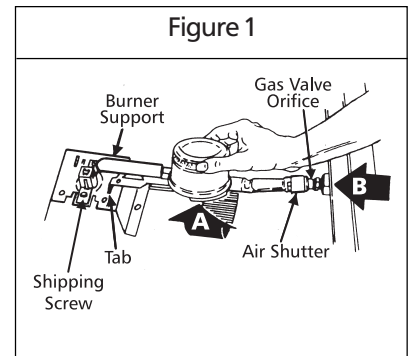

General Cleaning (continued)

Sealed Burner Models (some models)

Unlike the standard gas range, **THIS COOKTOP IS NOT REMOVABLE**. Do not attempt to remove or lift the cooktop.

⚠ CAUTION Before cleaning the cooktop, be sure the controls are turned to **OFF** and the cooktop is **COOL**.

⚠ WARNING **DO NOT** use a cooktop cleaner on a hot cooktop. The fumes can be hazardous to your health, and can chemically damage the ceramic- glass surface. Be sure the controls are turned to **OFF**. **Do not use commercial oven cleaners on any part of the cooktop. Damage to the finish or parts could result.**

To Clean the Tempered-glass Cooktop (some models)

The cooktop is designed to make cleaning easier. Because the four burners are sealed, cleanups are easy when spillovers are cleaned up immediately. To clean, wipe with a clean, damp cloth and wipe dry.

Correct and consistent cleaning is essential to maintaining your heat-resistant glass top. Spills and spatters should be wiped up using a clean paper towel and sudsy water. This should be done either as soon as possible after spill occurs, after cooking is completed, or at the latest, before using the cooktop again. Use caution if the cooktop is hot. For heavy spills, spatter or burned-on materials, use razor blade scraper. Hold the razor blade scraper at a 30° angle and remove food spills or burned on food residue.

For sugary spillovers:

Sugary spills can cause pitting of your cooktop surface. Therefore, you must begin cleaning the spills while the cooktop is still hot.

Finish the cleaning process by applying a recommended heat- resistant glass cooktop cleaning cream. Apply cleaner with clean, damp paper towel. Rinse with a paper towel dampened with clean water and wipe dry. Always wipe the cooktop thoroughly to avoid heating any cleaner residue.

Do NOT use the following on the heat-resistant glass cooktop:

- Abrasive plastic, nylon, metal scouring or cloth pads. They may scratch the cooktop and make it more difficult to clean later. Always use a new, clean paper towel when cleaning the heat-resistant glass top.
- Anything that may melt (plastics, aluminum foil, sugar or food with a high sugar content).
- Heavy duty cleansers, rust or stain removers.
- Chlorine bleach, ammonia, hydrofluoric acid or any other kind of chemical cleaners. They may etch or discolor the cooktop.
- Sponges, cloths or dish towels. Always use a new, clean paper towel when cleaning the cooktop. Lint or soil remaining on the cooktop from a cloth or sponge can burn and cause discoloration.



To Clean the Ceramic-glass Cooktop (some models)

The cooktop is designed to make cleaning easier. Cleanups are easy when spillovers are cleaned up immediately. To clean, wipe with a clean, damp cloth and wipe dry.

Correct and consistent cleaning is essential to maintaining your heat-resistant glass top. Spills and spatters should be wiped up using a clean paper towel and sudsy water. This should be done either as soon as possible after the spill occurs, after cooking is completed, or at the latest, before using the cooktop again. Use caution if the cooktop is hot. For heavy spills, spatter or burned-on materials, use a razor blade scraper. Hold the razor blade scraper at a 30° angle and remove food spills or burned on food residue.

For sugary spillovers:

Sugary spills can cause pitting of your cooktop surface. Therefore, you must begin cleaning the spills while the cooktop is still hot.

Finish the cleaning process by applying a recommended heat- resistant glass cooktop cleaning cream. Apply cleaner with clean, damp paper towel. Rinse with a paper towel dampened with clean water and wipe dry. Always wipe the cooktop thoroughly to avoid heating any cleaner residue.



Sealed Burner Models (some models) (continued)

To Clean the Ceramic-glass Cooktop (some models) (continued)

Special Caution for Aluminum Foil and Aluminum Cooking Utensils

1) Aluminum foil

Use of aluminum foil will damage the cooktop. Do not use under any circumstances.

2) Aluminum utensils

The melting point of aluminum being much lower than that of other metals, care must be taken when aluminum pots or pans are used. If allowed to boil dry, not only will the utensil be ruined, but also permanent damage in the form of breakage, fusing or marking may affect the ceramic glass surface.

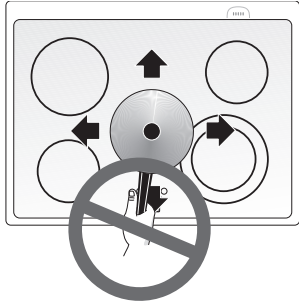

Sliding aluminum or copper clad bottom pans on the cooktop can cause metal markings on the cooktop surface. These marks should be removed **immediately** after the cooktop has cooled using the cooktop cleaning cream. Metal marks can become permanent if not removed prior to future use.

Cookware (cast iron, metal, ceramic or glass) with rough bottoms can mark or scratch the cooktop surface. **Do not slide anything metal or glass** across the cooktop. **Do not** use your cooktop as a cutting board or work surface in the kitchen. **Do not** cook foods directly on the cooktop surface without a pan.

Do not drop heavy or hard objects on the glass cooktop, they may cause it to crack.

Things to Remember

1. AVOID using bleach and don't use ammonia to clean the ceramic surface.
2. Do not put plastic items on warm cooking areas.
3. Never slide oven racks across cooktop surface. They may scratch or metalmark the cooktop.
4. **If cooktop should break, do not use cooktop or attempt to clean it. Call your authorized service technician immediately.**
5. Never use a trivet or metal stand between the cooking utensil and the ceramic cooktop. The ceramic surface may be scratched, metal marked or etched by such items.
6. Sugary spills can cause pitting of your cooktop surface. Therefore, you must begin cleaning the spills while the cooktop is still hot. Use caution when following the steps below.
 - a) Turn off all surface units and remove all pans immediately.
 - b) Wearing an oven mitt, use a razor blade scraper to scrape the hot spill out of the cooking zone to a cooler area on the cooktop.
 - c) Allow the cooktop to cool.

Use and Care of Glass Surface

Problem	Cause	To Prevent	To Remove
Fine "brown lines" (tiny scratches or abrasions which have collected soil)	Coarse particles (salt, sand, sugar or grit) between bottom of cookware and cooktop that are not removed before cooking. Using incorrect cleaning materials.	Clean cooktop after every use. Daily use of cleaner cream.	Tiny scratches are not removable. They can be minimized by continual use of cleaner cream. Such scratches do not affect cooking.
Metal marking (mark or black marks).	Sliding or scraping metal utensils or oven shelves across cooktop.	Do not slide cookware across cooktop.	Apply cleaner cream with dampened paper towel to a cooled surface.
Brown streaks and specks.	Cleaning with a sponge or dishcloth that has been used for other kitchen tasks.	Use cleaner cream with clean, damp paper towel.	Use a small amount of cleaner cream with clean, damp paper towel.

NOTE: Due to the high intensity of heat generated by the surface elements, the glass surface will turn green when the element will be turned off. This phenomenon is normal and the glass will come back to its original white color after it has completely cooled down. (White glass cooktops only).

Ceramic Glass Cooktop (some models) (continued)

Sealed Burner Model (some models) (continued)

Use and Care of Glass Surface (continued)

Cleaning Materials for Ceramic Glass Cooktop

Some cleaning materials may contain an ingredient which can damage the cooktop. Use recommended materials only (see below). Cleaner cream should be used regularly. Prior to using your cooktop for the first time, apply a cleaner cream to the ceramic surface. A sample of **CERAMA BRYTE®** cleaner cream is supplied with your range. More are available in stores if needed.

Use only recommended cleaning products and follow these basic cleaning suggestions.

1. BEFORE THE COOKTOP IS USED. Thoroughly clean and saturate the cooktop with cleaner cream.
 - a) Dampen clean paper towel and clean unit.
 - b) Wipe off with another clean, damp paper towel; then wipe dry.
2. For normal daily cleaning, apply a dab of cleaner cream in the center of each unit-area to be cleaned. Start with approximately 1/8 teaspoon. (Apply more if needed). Then, proceed as stated above in (a and b).
3. Make sure bottom of cookware and cooking area are clean and dry.
4. Select heat settings and cookware large enough for food and liquid. This stops boilovers and splatterings.
5. Wipe up food spills and spatters before they burn into surface.

IMPORTANT Regularly use cleaner cream. If you run out of cleaner cream, use one of the cleansers listed. Be sure to get a new supply of cleaner cream.

CAUTION Never mix cleaning products! Mixtures may interact, with damaging or hazardous results.

Do Use on Ceramic Glass Cooktop

1. Baking soda.
2. Non-impregnated plastic and nylon pads.
3. For burned on material, scrape with single-edged razor blade, held at a 30° angle.
4. Ceramic glass cleaning cream.
5. **CERAMA BRYTE®** cleaner cream.

Do not Use on Ceramic Glass Cooktop

1. Avoid pads, that can leave marks and scratches.
2. Avoid heavy-duty cleansing powders, these can scratch, depending on their abrasiveness and cleaning pressure applied.
3. Avoid chemical oven cleaners. These can etch the cooktop surface and are caustic.
4. Avoid rust stain removers containing hydrofluoric acid.
5. Avoid using bleach and don't use ammonia.

Special Cleaning Instructions for Mineral Deposits and Discolorations

Problem: A gray brown stain that is not removed when using cleaner cream.

Cause: Condensation, when cooking, often collects and drips from cookware. The minerals found in water supply and foods may cause a gray or brown film to develop on cooktop. This film is so thin it cannot be felt and appears to be under cooktop.

To Prevent: Daily and proper use of cleaner cream.

To Remove:

- Wet surface with water and sprinkle on cleaner cream.
- Scrub with clean, damp paper towel until stain disappears.
- Clean remaining paste away with damp paper towel.
- Apply dab of cleaner cream and polish with a clean paper towel.

WARNING

- Do not use cleansers on a heated surface. Fumes could be hazardous. Wait for area to cool before cleaning.
- Do not use cleaner cream to clean porcelain, paint or aluminium.

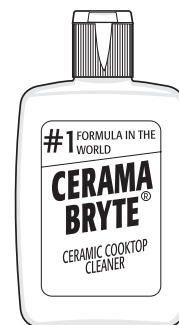

CERAMA BRYTE®
(Cleaner cream for ceramic cooktops)

General Cleaning (continued)

Sealed Burner Models (some models) (continued)

To Clean the Burner Grates, Contoured Burner Pans, Burner Cap and Burner Base

The burner grates, contoured burner pans, burner caps and burner base should be routinely cleaned. Keeping the burner ports clean will prevent improper ignition and an uneven flame. See instructions below.

To Clean the Burner Grates

Be sure burners and grates are cool before you place your hand, a pot holder, cleaning cloths or other material on them. The cast iron burner grates can be washed in hot soapy water. Rinse thoroughly and dry the grates with a cloth - don't put them on the cooktop while still wet. Be sure the grates are positioned securely over the burners.

To remove burned on food, place the grates in a covered container or plastic bag. Add 1/4 cup ammonia and soak for 30 minutes. Wash, rinse well and dry. An abrasive cleaner can be used for stubborn stains.

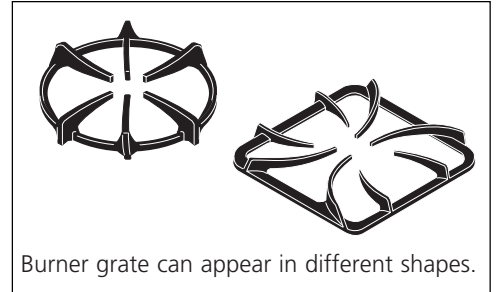

To Clean the Contoured Burner Pans

The burner pans are attached to the cooktop and are not removable. The burner pan forms a recessed well area located around each burner unit. If spill occurs in one of the well areas, blot up spill with an absorbent cloth. Rinse with a clean, damp cloth and wipe dry.

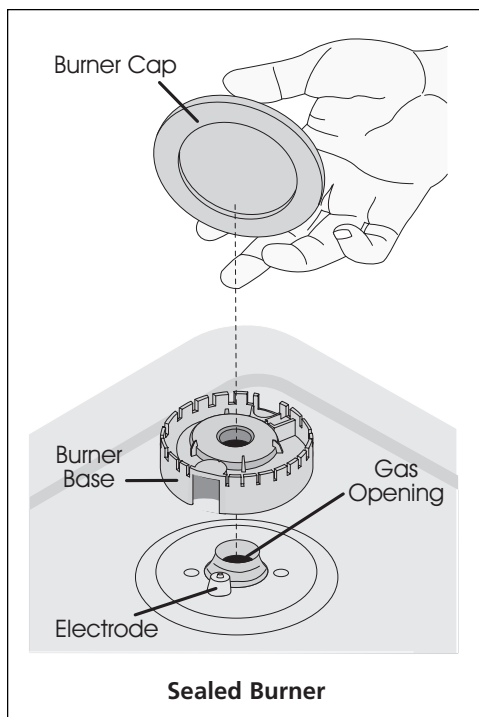

To Clean the Burner Cap

Remove burner cap. Use soap-filled pad or mild abrasive cleanser to clean burner caps. If necessary, cover stubborn spots with an ammonia-soaked paper towel for 30 minutes. Rub gently with a mixture of clean water and vinegar. Wipe dry. Remove all cleaners or the porcelain may become damaged during future heating.

To Clean the Removable Burner Base and Gas Opening (some models)

The ports (or slots) around the burner base must be routinely cleaned. Use a small-gauge wire or needle to clean small slots or holes.

Note: If the electrode is damaged or broken, the surface burner will not light because it will not spark. Manual lighting with a match is still possible.

For proper flow of gas and ignition of the burner - DO NOT ALLOW SPILLS, FOOD, CLEANING AGENTS OR ANY OTHER MATERIAL TO ENTER THE GAS OPENING TUBE. Gas must flow freely through the small hole in the brass orifice for the burners to light properly. If the gas opening orifice becomes soiled or clogged, use a small-gauge or needle to clean. ALWAYS keep the burner cap in place whenever a surface burner is in use.

To Replace the Burner Base and the Burner Cap

Make sure the pieces are thoroughly dry before placing back.

1. Replace burner base and burner cap at their place. Make sure each burner cap and burner base are properly aligned and leveled.
2. Replace the burner grate.
3. Turn the burner on to determine if it lights. If the burner does not light after cleaning, contact an authorized servicer. Do not service the sealed burner yourself.

Avoid Service Checklist

Before you call for service, review this list. It may save you time and expense. The list includes common occurrences that are not the result of defective workmanship or materials in this appliance.

OCCURRENCE	POSSIBLE CAUSE/SOLUTION
Surface burners do not light.	Surface Control knob has not been completely turned to LITE. Push in and turn the Surface Control knob to LITE until burner ignites and then turn control to desired flame size.
	Be sure gas supply valve is open.
	Gas-air mixture needs a straight line to travel. Be sure burner is properly seated in its support (models with open burners only).
	Burner ports or slots are clogged. With the burner off, use a small-gauge wire or needle to clean ports or slots.
	Power cord is disconnected from outlet (electric ignition models). Be sure cord is plugged securely into outlet.
	Electrical power outage (electric ignition models). Burners can be lit manually. See Setting Surface Controls in this Owner's Guide.
Surface burner flame burns half way around.	Burner ports or slots are clogged. With the burner off, clean ports with a small-gauge wire or needle to clean ports or slots.
	Moisture is present after cleaning. Lightly fan the flame and allow burner to operate until flame is full. Dry the burners thoroughly following instructions under General Cleaning .
Surface burner flame is orange.	Dust particles in main line. Allow the burner to operate a few minutes until flame turns blue.
	In coastal areas, a slightly orange flame is unavoidable due to salt air.
Scratches or abrasion on cooktop surface.	Coarse particles such as salt or sand between cooktop and utensil can cause scratches. Be sure cooktop surface and bottoms of utensils are clean before usage. Small scratches do not affect cooking and will become less visible with time.
	Cleaning materials not recommended for ceramic-glass cooktop have been used. See "To Clean the Ceramic-glass Cooktop" section under General Cleaning.
	Cookware with rough bottom has been used. Use smooth, flat-bottomed cookware.
Metalmarks.	Sliding or scraping of metal utensils on cooktop surface. Do not slide metal utensils on cooktop surface. Use ceramic-glass cooktop cleaning cream to remove the marks. See "To Clean the Ceramic-glass Cooktop" section under General Cleaning.
Brown streaks or specks.	Boilover are cooked onto surface. Use razor blade scraper to remove soil. See "To Clean the Ceramic-glass Cooktop" section under General Cleaning.
Areas of discoloration with metallic sheen.	Mineral deposits from water and food. Remove using a ceramic-glass cooktop cleaning cream. Use cookware with clean, dry bottoms.



Major Appliance Warranty Information

Your appliance is covered by a one year limited warranty. For one year from your original date of purchase, Electrolux will pay all costs for repairing or replacing any parts of this appliance that prove to be defective in materials or workmanship when such appliance is installed, used and maintained in accordance with the provided instructions.

Exclusions **This warranty does not cover the following:**

1. Products with original serial numbers that have been removed, altered or cannot be readily determined.
2. Product that has been transferred from its original owner to another party or removed outside the USA or Canada.
3. Rust on the interior or exterior of the unit.
4. Products purchased "as-is" are not covered by this warranty.
5. Food loss due to any refrigerator or freezer failures.
6. Products used in a commercial setting.
7. Service calls which do not involve malfunction or defects in materials or workmanship, or for appliances not in ordinary household use or used other than in accordance with the provided instructions.
8. Service calls to correct the installation of your appliance or to instruct you how to use your appliance.
9. Expenses for making the appliance accessible for servicing, such as removal of trim, cupboards, shelves, etc., which are not a part of the appliance when it is shipped from the factory.
10. Service calls to repair or replace appliance light bulbs, air filters, water filters, other consumables, or knobs, handles, or other cosmetic parts.
11. Surcharges including, but not limited to, any after hour, weekend, or holiday service calls, tolls, ferry trip charges, or mileage expense for service calls to remote areas, including the state of Alaska.
12. Damages to the finish of appliance or home incurred during installation, including but not limited to floors, cabinets, walls, etc.
13. Damages caused by: services performed by unauthorized service companies; use of parts other than genuine Electrolux parts or parts obtained from persons other than authorized service companies; or external causes such as abuse, misuse, inadequate power supply, accidents, fires, or acts of God.

DISCLAIMER OF IMPLIED WARRANTIES; LIMITATION OF REMEDIES

CUSTOMER'S SOLE AND EXCLUSIVE REMEDY UNDER THIS LIMITED WARRANTY SHALL BE PRODUCT REPAIR OR REPLACEMENT AS PROVIDED HEREIN. CLAIMS BASED ON IMPLIED WARRANTIES, INCLUDING WARRANTIES OF MERCHANTABILITY OR FITNESS FOR A PARTICULAR PURPOSE, ARE LIMITED TO ONE YEAR OR THE SHORTEST PERIOD ALLOWED BY LAW, BUT NOT LESS THAN ONE YEAR. ELECTROLUX SHALL NOT BE LIABLE FOR CONSEQUENTIAL OR INCIDENTAL DAMAGES SUCH AS PROPERTY DAMAGE AND INCIDENTAL EXPENSES RESULTING FROM ANY BREACH OF THIS WRITTEN LIMITED WARRANTY OR ANY IMPLIED WARRANTY. SOME STATES AND PROVINCES DO NOT ALLOW THE EXCLUSION OR LIMITATION OF INCIDENTAL OR CONSEQUENTIAL DAMAGES, OR LIMITATIONS ON THE DURATION OF IMPLIED WARRANTIES, SO THESE LIMITATIONS OR EXCLUSIONS MAY NOT APPLY TO YOU. THIS WRITTEN WARRANTY GIVES YOU SPECIFIC LEGAL RIGHTS. YOU MAY ALSO HAVE OTHER RIGHTS THAT VARY FROM STATE TO STATE.

If You Need Service

Keep your receipt, delivery slip, or some other appropriate payment record to establish the warranty period should service be required. If service is performed, it is in your best interest to obtain and keep all receipts. Service under this warranty must be obtained by contacting Electrolux at the addresses or phone numbers below.

This warranty only applies in the USA and Canada. In the USA, your appliance is warranted by Electrolux Major Appliances North America, a division of Electrolux Home Products, Inc. In Canada, your appliance is warranted by Electrolux Canada Corp. Electrolux authorizes no person to change or add to any obligations under this warranty. Obligations for service and parts under this warranty must be performed by Electrolux or an authorized service company. Product features or specifications as described or illustrated are subject to change without notice.

USA
1.800.944.9044
Electrolux Major Appliances
North America
P.O. Box 212378
Augusta, GA 30907



Canada
1.800.668.4606
Electrolux Canada Corp.
5855 Terry Fox Way
Mississauga, Ontario, Canada
L5V 3E4