







Use & Care Manual

Gas Cooktop

Welcome	2	
Important Safety Instructions ..	3-5	
Before Setting Surface Controls	6	
Setting Surface Controls	7	
Care & Cleaning	8-11	
Before You Call Solutions to Common Problems	11	
Warranty	12	

Visit the Frigidaire Web Site at:
<http://www.frigidaire.com>



Welcome & Congratulations

Questions?

1-800-944-9044

(United States)

1-866-294-9911

(Canada)

Please attach sales receipt here for future reference.

Congratulations on your purchase of a new appliance! At **Electrolux Home Products**, we are very proud of our product and are completely committed to providing you with the best service possible. Your satisfaction is our number one priority.

We know you'll enjoy your new appliance and **Thank You** for choosing our product. We hope you consider us for future purchases.

PLEASE CAREFULLY READ AND SAVE THESE INSTRUCTIONS

This Use & Care Manual contains general operating instructions for your appliance and feature information for several models. Your product **may not** have all the described features. The graphics shown are representative. The graphics on your appliance may not look exactly like those shown. These instructions are not meant to cover every possible condition and situation that may occur. Common sense and caution must be practiced when installing, operating and maintaining any appliance.

Please record your model and serial numbers below for future reference.

Model Number: _____

Serial Number: _____

Purchase Date: _____

Product Registration

Register Your Product

The **PRODUCT REGISTRATION CARD** should be filled in completely, signed and returned to Electrolux Home Products.

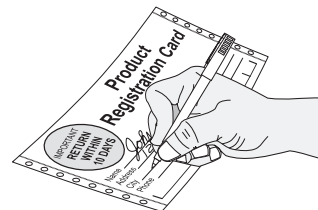

Serial Plate Location

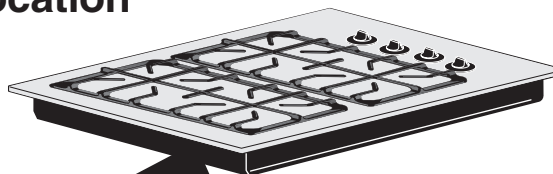

Cooktop Serial Plate Location



Versión en español

Si desea obtener una copia en español de este Manual del Usuario, sírvase escribir a la dirección que se incluye a continuación. Solicite la P/N 318200672sp.

Spanish Use & Care Manual
Electrolux Home Products
P. O. Box 212378
Augusta, GA 30917

Important Safety Instructions



**Read all instructions before using this appliance.
Save these instructions for future reference.**

This manual contains important safety symbols and instructions. Please pay attention to these symbols and follow all instructions given.

⚠ WARNING This symbol will help alert you to situations that may cause serious bodily harm, death or property damage.

⚠ CAUTION This symbol will help alert you to situations that may cause bodily injury or property damage.

⚠ WARNING If the information in this manual is not followed exactly, a fire or explosion may result causing property damage, personal injury or death.

FOR YOUR SAFETY:

- **Do not store or use gasoline or other flammable vapors and liquids in the vicinity of this or any other appliance.**
 - **WHAT TO DO IF YOU SMELL GAS:**
 - **Do not try to light any appliance.**
 - **Do not touch any electrical switch; do not use any phone in your building.**
 - **Immediately call your gas supplier from a neighbor's phone. Follow the gas supplier's instructions.**
 - **If you cannot reach your gas supplier, call the fire department.**
 - **Installation and service must be performed by a qualified installer, servicer or the gas supplier.**
-
- **Remove all tape and packaging wrap before using the cooktop. Destroy the carton and plastic bags after unpacking the cooktop.** Never allow children to play with packaging material. Do not remove the model/serial plate attached to the cooktop.
 - **Proper Installation—Be sure your appliance is properly installed and grounded by a qualified technician in accordance with the National Fuel Gas Code ANSI Z223.1 latest edition and CAN/CGA B149.2, and the National Electrical Code ANSI/NFPA No. 70—latest edition, and local code requirements.** Install and/or adjust only per installation instructions provided in the literature package for this cooktop.
- Ask your dealer to recommend a qualified technician and an authorized repair service. Know how to shut off gas supply at the meter and disconnect the electrical power to the cooktop at the circuit breaker or fuse box in case of an emergency.
- **User Servicing—Do not repair or replace any part of the appliance unless specifically recommended in the manuals.** All other servicing should be done only by a qualified technician. This may reduce the risk of personal injury and damage to the cooktop.
 - **Never modify or alter the construction of a cooktop by removing panels, wire covers, or any other part of the product.**

- **Storage on Appliance—Flammable materials should not be stored on the cooktop, near surface burners.** This includes paper, plastic and cloth items, such as cookbooks, plasticware and towels, as well as flammable liquids. Do not store explosives, such as aerosol cans, on the cooktop. Flammable materials may explode and result in fire or property damage.

⚠ CAUTION Do not store items of interest to children in the cabinets above the cooktop.

- **Do not leave children alone—Children should not be left alone or unattended in the area where an appliance is in use.** They should never be allowed to sit or stand on any part of the appliance.
- **DO NOT TOUCH SURFACE BURNERS, GRATES, OR AREAS NEAR THESE BURNERS.** Surface burners may be hot even though the flames are not visible. Areas near surface burners may become hot enough to cause burns. During and after use, do not touch or let clothing or other flammable materials touch these areas until they have had sufficient time to cool. Among these areas are the cooktop and the surfaces facing the cooktop.
- **Wear Proper Apparel—Loose-fitting or hanging garments should never be worn while using the appliance.** Do not let clothing or other flammable materials contact hot surfaces.

⚠ WARNING Stepping or leaning on this cooktop can result in serious injuries and may also cause damage to the cooktop. Do not allow children to climb or play around the cooktop.

⚠ WARNING NEVER use this appliance as a space heater to heat or warm the room. Doing so may result in carbon monoxide poisoning.



Important Safety Instructions

- **Do Not Use Water or Flour on Grease Fires—Smother the fire with a pan lid, or use baking soda, a dry chemical or foam-type extinguisher.**
 - **When heating fat or grease, watch it closely.** Fat or grease may catch fire if allowed to become too hot.
 - **Use Only Dry Pot holders—Moist or damp pot holders on hot surfaces may result in burns from steam.** Do not let the pot holders touch the flame or burners. Do not use a towel or other bulky cloth instead of a pot holder.
 - **Do Not Heat Unopened Food Containers—Buildup of pressure may cause container to burst and result in injury.**
 - **Know which knob controls each surface burner.** Always turn the knob to the LITE position when igniting the burners. Visually check that the burner has lit. Then adjust the flame so it does not extend beyond the edge of the utensil.
- ⚠ WARNING Use Proper Flame Size—Adjust flame size so it does not extend beyond the edge of the utensil.** The use of undersized utensils will expose a portion of the burner flame to direct contact and may result in ignition of clothing. Proper relationship of utensil to flame will also improve efficiency.
- ⚠ WARNING Do not use stove top grills on your sealed gas burners.** If you use a stove top grill on a sealed gas burner, it will cause incomplete combustion and can result in exposure to carbon monoxide levels above allowable current standards. This can be hazardous to your health.
- **Use proper pan size—**This appliance is equipped with one or more surface burners of different sizes. Select utensils having flat bottom large enough to cover the surface burner. The use of undersized utensils will expose a portion of the surface burner to direct contact and may result in ignition of clothing. Proper relationship of utensil to the surface burner will also improve efficiency.
 - **Utensil Handles Should Be Turned Inward and Not Extend Over Adjacent Surface Burners—**To reduce the risk of burns, ignition of flammable materials, and spillage due to unintentional contact with the utensil, the handle of the utensil should be positioned so that it is turned inward, and does not extend over adjacent surface burners.
 - **Never Leave Surface Burners Unattended at High Heat Settings—**Boilovers cause smoking and greasy spillovers that may ignite, or a pan that has boiled dry may melt.
 - **Protective Liners—**Do not use aluminum foil to line surface burner pans. Protective liners or aluminum foil may interfere with heat and air distribution, and combustion. Damage to the cooktop or personal injury may result.
 - **Glazed Cooking Utensils—**Only certain types of glass, glass/ceramic, ceramic, earthenware, or other glazed utensils are suitable for cooktop service without breaking due to the sudden change in temperature. Check the manufacturer's recommendations for cooktop use.
 - **Do Not Use Decorative Surface Burner Covers.** If a burner is accidentally turned on, the decorative cover will become hot and possibly melt. You will not be able to see that the burner is on. Burns will occur if the hot covers are touched. Damage may also be done to the cooktop or burners because the covers may cause overheating. Air will be blocked from the burner and cause combustion problems.

GLASS COOKTOPS (some models):

- **Do Not Operate or Clean a Broken Cooktop Glass—**If glass top should break, cleaning solutions and spillovers may penetrate the broken cooktop and create a risk of electric shock. Contact a qualified technician immediately.
- **Clean Cooktop Glass with Caution—**If a wet sponge or cloth is used to wipe spills on a hot cooking area, be careful to avoid a steam burn. Some cleaners can produce harmful fumes if applied to a hot surface.
- **Avoid scratching the cooktop glass with sharp objects.**

IMPORTANT SAFETY NOTICE

The California Safe Drinking Water and Toxic Enforcement Act requires the Governor of California to publish a list of substances known to the state to cause cancer, birth defects or other reproductive harm, and requires businesses to warn customers of potential exposure to such substances.

SAVE THESE INSTRUCTIONS

Important Safety Instructions



Grounding Instructions

For personal safety, the cooktop must be properly grounded. For maximum safety, the power cord must be plugged into an electrical outlet that is correctly polarized and properly grounded.

DO NOT operate the cooktop using a 2-prong adapter or an extension cord. If a 2-prong wall receptacle is the only available outlet, it is the personal responsibility of the consumer to have it replaced with a properly grounded 3-prong wall receptacle installed by a qualified electrician.

See the **INSTALLATION INSTRUCTIONS** packaged with this cooktop for complete installation and grounding instructions.

⚠ WARNING This appliance is equipped with a 3-prong grounding plug for your protection against shock hazard and should be plugged directly into a properly grounded receptacle. **DO NOT** cut or remove the grounding prong from this plug.

Grounding type wall receptacle

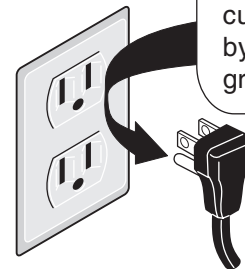

Do not, under any circumstances, cut, remove, or bypass the grounding prong.

Power supply cord with 3-prong grounding plug

⚠ WARNING Avoid fire hazard or electrical shock. **DO NOT** use an adapter plug, an extension cord, or remove grounding prong from electrical power cord. Failure to follow this warning can cause serious injury, fire or death.

Conversion to Liquefied Petroleum Gas (or L.P. Gas)

This natural gas range is designed to allow for conversion to Liquefied Petroleum (L.P.) Gas.

If L.P. conversion is needed, contact the service center for assistance. The L.P. Conversion Kit is provided with this cooktop and is located in the literature envelope. Before installing the kit be sure to follow the L.P. Installation Instructions carefully.

⚠ WARNING Personal injury or death from electrical shock may occur if the range is not installed by a qualified installer or electrician.

⚠ CAUTION Any additions, changes or conversions required in order for this appliance to satisfactorily meet the application needs must be made by an authorized Service Center.

Before Setting Surface Controls

Assembly of the Surface Burner Heads, Burner Caps and Burner Grates (Porcelain & Stainless Steel Cooktop models)

It is very important to make sure that all of the Surface Burner Heads, Surface Burner Caps and Surface Burner Grates are installed correctly and at the correct locations.

1. Remove all packing tape from cooktop area. Remove all Burner Caps and Burner Heads.
2. Discard all packing material located under Burner Heads (if applicable).
3. To replace the Burner Heads & Caps, match the letters located under center of Burner Caps with the letters located inside Burner Heads (Figure 1).
4. Match Burner Skirts (some models) or the emboss on the cooktop with Burner Heads and Burner Caps (see Figure 1). Replace the Burner Heads and Caps on cooktop (see Figure 2). Carefully align the Electrodes into slot or hole of each Burner Head (Figure 3). Note: The Burner Heads should sit flat on Cooktop Burner Skirts.
5. Unpack Burner Grates and position on the cooktop.

REMEMBER — DO NOT ALLOW SPILLS, FOOD, CLEANING AGENTS OR ANY OTHER MATERIAL TO ENTER THE GAS ORIFICE HOLDER OPENING. Always keep the Burner Caps and Burner Heads in place whenever the surface burners are in use.

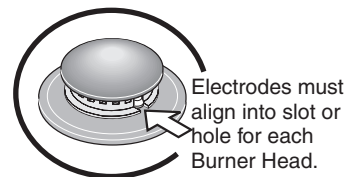

Figure 2

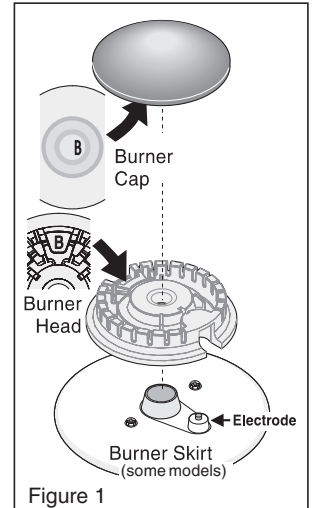

Figure 1

Assembly of the Surface Burner Heads, Burner Caps and Burner Grates (Ceramic Glass Cooktop models)

It is very important to make sure that all of the Surface Burner Heads, Surface Burner Caps and Surface Burner Grates are installed correctly and at the correct locations.

1. Be sure to follow the Installation Instructions before installing and using your new cooktop.
2. Remove all packing tape from cooktop. Remove Burner Caps and Burner Heads (See Figure 3).
3. Discard all packing material located under all Burner Heads (if applicable).
4. To replace Burner Heads & Caps, match the letters located under center of Burner Caps with the letters located inside Burner Head (See Figure 5). Place all Burner Heads & Caps on the cooktop while carefully aligning the Electrodes into slots or holes of the Burner Heads (Figure 4). Note: The Burner Heads should sit flat on Cooktop Burner Skirts.
5. Unpack Burner Grates. NOTE: Do not force End Burner Grates down on cooktop. Be careful to line up the 2 Grate Pins located on each of the 2 End Burner Grates into the Pilot holes located on top of the Burner Caps (See Figure 5). Position Burner Grates on cooktop and check that all the Burner Grate legs lie on the glass surface.

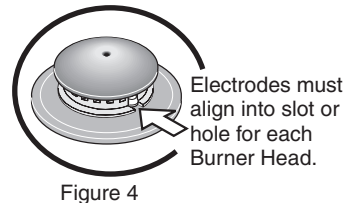

Figure 4

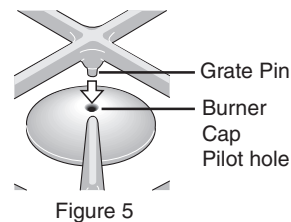

Figure 5

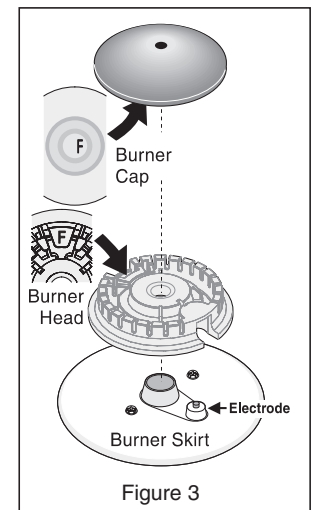

Figure 3

REMEMBER — DO NOT ALLOW SPILLS, FOOD, CLEANING AGENTS OR ANY OTHER MATERIAL TO ENTER THE GAS ORIFICE HOLDER OPENING. Always keep the Burner Caps and Burner Heads in place whenever the surface burners are in use.

Setting Surface Controls

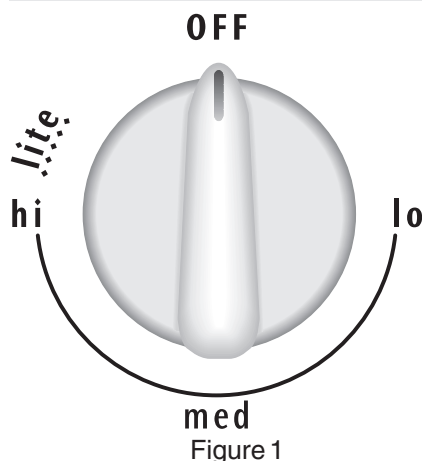

Figure 1

Operating the Gas Surface Controls:

1. Place cooking utensil on surface burner.
2. Push the surface control knob down and turn **counterclockwise** out of the OFF position.
3. Release the knob and rotate to the LITE position (see figure 1). Note: All four electronic surface igniters will spark at the same time. However, only the burner you are turning on will ignite.
4. Visually check that the burner has a flame.
5. Turn the control knob **counterclockwise** to the desired flame size. The control knobs do not have to be set at a particular setting. Use the knob indicator settings to adjust the flame as needed. **DO NOT** cook with the surface control knob in the LITE position. (The electronic ignitor will continue to spark if the knob is left in the LITE position.)

⚠ CAUTION Do not place plastic items such as salt and pepper shakers, spoon holders or plastic wrappings on top of the range when it is in use. These items could melt or ignite. Potholders, towels or wood spoons could catch fire if placed too close to a flame.

⚠ CAUTION Do not operate the burner for an extended period of time without cookware on the grate. The finish on the grate may chip without cookware to absorb the heat.

In the event of an electrical power outage, the surface burners can be lit manually. To light a surface burner, hold a lit match to the burner head, then slowly turn the surface control knob to **LITE**. After burner lights turn the knob to desired setting. Use caution when lighting surface burners manually.

Setting Proper Surface Burner Flame Size

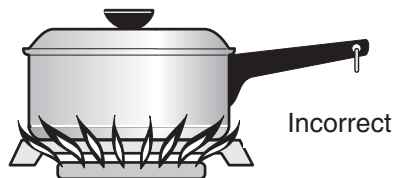
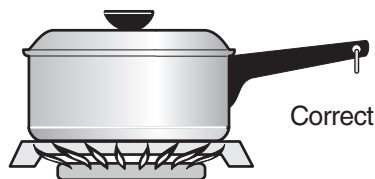

For most cooking - start on the highest control setting and then turn to a lower one to complete the process. Use the recommendations below as a guide for determining proper flame size for various types of cooking. The size and type of utensil used and the amount of food being cooked will influence the setting needed.

*Flame Size

High Flame
Medium Flame
Low Flame

Type of Cooking

Start most foods; bring water to a boil; pan broiling.
Maintain a slow boil; thicken sauces, gravies; steaming.
Keep foods cooking; poach; stewing.

Never extend the flame beyond the outer edge of the utensil. A higher flame simply wastes heat and energy, and increases the risk of being burned by the gas flame.

For deep fat frying - use a thermometer and adjust the surface control knob accordingly. If the fat is too cool, the food will absorb the fat and be greasy. If the fat is too hot, the food will brown so quickly that the center will be undercooked. Do not attempt to deep fat fry too much food at once as the food will neither brown nor cook properly.

***Note: Settings are based on using medium-weight metal or aluminum pans. Settings may vary when using other types of pans.** The color of the flame is the key to proper burner adjustment. A good flame is clear, blue and hardly visible in a well-lighted room. Each cone of flame should be steady and sharp. Clean burner if flame is yellow-orange.



Care & Cleaning (Cleaning Chart)

Cleaning Various Parts of Your Cooktop

Before cleaning any part of the cooktop, be sure all controls are turned OFF and the cooktop is COOL. REMOVE SPILLOVERS AND HEAVY SOILING AS SOON AS POSSIBLE. REGULAR CLEANING WILL REDUCE THE NUMBER OF MAJOR CLEANING LATER.

Surfaces

How to Clean

Aluminum (Trim Pieces) & Vinyl

Use hot, soapy water and a cloth. Dry with a clean cloth.

Glass, Painted and Plastic Control Knobs, Body Pieces, and Decorative Trim

Using a soft cloth, clean with mild dish detergent and water or a 50/50 solution of vinegar and water. Follow by rinsing the area with clean water; dry and polish with a soft cloth. Glass cleaners may be used if sprayed on a soft cloth first. **DO NOT** spray liquids directly on the control pad and display area. Do not use large amounts of water on the control panel - excess water on the control area may cause damage to the appliance. Do not use other liquid cleaners, abrasive cleaners, scouring pads, or some paper towels - they will damage the finish.

Control Panel

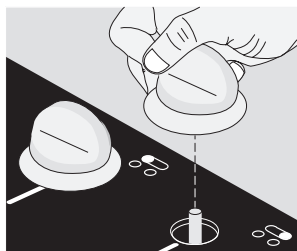

Wipe the control panel clean after each use. Before cleaning the control panel, turn all controls to OFF and remove the control knobs. To remove, pull each knob straight off the shaft. Clean using hot, soapy water and a cloth. Be sure to squeeze excess water from the cloth before wiping the panel; especially when wiping around the controls. Excess water in or around the controls may cause damage to the appliance. To replace knobs after cleaning, line up the flat sides of both the knob and the shaft; then push the knob into place.

Stainless Steel, Chrome Decorative Trim (some models)

Clean **stainless steel** with hot, soapy water and a dishcloth. Rinse with clean water and a cloth. **Do not use cleaners with high concentrations of chlorides or chlorines.** Do not use harsh scrubbing cleaners. Only use kitchen cleaners that are especially made for cleaning stainless steel. Always be sure to rinse the cleaners from the surface as bluish stains may occur during heating that cannot be removed.

Porcelain Enamel Burner Grates, Burner Rings (some models), Cooktop Surface (some models)

Gentle scouring with a soapy scouring pad will remove most spots. Rinse with a 1:1 solution of clear water and ammonia. If necessary, cover difficult spots with an ammonia-soaked paper towel for 30 to 40 minutes. Rinse with clean water and a damp cloth, and then scrub with a soap-filled scouring pad. Rinse and wipe dry with a clean cloth or paper towel. Remove all cleaners or the porcelain may become damaged during future heating. **DO NOT** use spray oven cleaners on the cooktop.

Surface Burners

The holes in the burners of your cooktop must be kept clean at all times for proper ignition and a complete, even flame. Clean the burner holes routinely with a small gauge wire or needle and especially after bad spillovers which could clog these holes.

To remove and replace burner units per your model, see instructions under **General Cleaning**. To clean, soak the burners in a 1:1 solution of ammonia and water for 30 to 40 minutes. For stubborn stains, scrub with soap and water or a mild abrasive cleanser and damp cloth. Dry the burners thoroughly in a warm oven for 30 minutes. Then replace them, making sure they are seated and level. **DO NOT** wash burner units in the dishwasher.

Care & Cleaning



Cleaning the Cooktop, Burner Heads, Caps & Grates

The cooktop is designed to make cleaning easier. Because the gas Burners are sealed, cleanups are easy when spills are cleaned up immediately.

The cooktop, Burner Heads and Caps should be routinely cleaned. Keeping the Burner Head Ports clean will prevent improper ignition and an uneven flame. Refer to the following instructions:

THE COOKTOP IS NOT REMOVABLE. Do not attempt to remove or lift the cooktop.

CAUTION Use caution when replacing the Burner Caps so the Electrodes are not damaged. This may cause a delayed ignition or prevent the burner from igniting.

CAUTION Any additions, changes or conversions required in order for this appliance to perform satisfactorily must be made by an authorized Service Center.

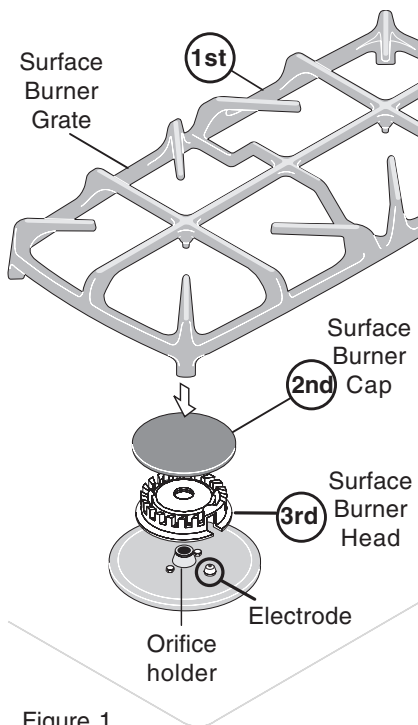

Figure 1

To Remove and Replace the Surface Burner Caps and Burner Heads -

Remove in the following order: (1st) surface Burner Grates, (2nd) Burner Caps and (3rd) Burner Heads. Replace in the following order: Burner Heads, Burner Caps and Burner Grates.

Do not remove any parts from the cooktop until they have completely cooled and are safe to handle. Do not operate the surface Burners without the Burner Caps and Burner Heads properly in place.

To Clean the surface Burner Caps and Burner Heads (all models)- Use a soap-filled scouring pad or a mild abrasive cleanser to clean the surface Burner Caps and Burner Heads. The ports (or slots) around the Burner Heads must be routinely cleaned. If residue still remains in these ports, use a small-gauge wire or needle to clean the slots or holes. For proper flow of gas and ignition of the burner—**DO NOT ALLOW SPILLS, FOOD, CLEANING AGENTS OR ANY OTHER MATERIAL TO ENTER THE GAS ORIFICE HOLDER OPENING. ALWAYS** keep the surface Burner Caps and Burner Heads in place whenever the gas Burners are in use.

To Clean the Burner Grates (all models)- Be sure burners and grates are cool before you place your hand, a pot holder, cleaning cloths or other material on them. The cast iron burner grates can be washed in hot soapy water. Rinse thoroughly and dry the grates with a cloth - don't put them on the cooktop while still wet. Be sure the grates are positioned securely over the burners.

To remove burned on food, place the grates in a covered container or plastic bag. Add 1/4 cup ammonia and soak for 30 minutes. Wash, rinse well and dry. An abrasive cleaner can be used for stubborn stains.

To Clean the Cooktop and contoured areas of the cooktop (for models with Porcelain Cooktop only)- If a spill occurs on the porcelain cooktop, blot up spill with an absorbent cloth. Rinse with a clean, damp cloth and wipe dry. Do not use harsh abrasive cleaners on the cooktop. They can scratch the porcelain. Completely rinse any mild cleaners used from the surface or the porcelain cooktop may become damaged during future heating. **DO NOT** use spray oven cleaners on the cooktop.

To Clean the Ceramic Glass Cooktop (for models with Ceramic Glass Cooktop only)- See Ceramic Glass Cooktop Cleaning & Maintenance later in this section.



Care & Cleaning

Models with Ceramic Glass Cooktop (Some Models) Ceramic Glass Cooktop Cleaning & Maintenance

Consistent and proper cleaning is essential to maintaining your Ceramic glass cooktop

Prior to using your cooktop for the first time, apply the recommended CERAMA BRYTE® Cleaning Creme to the ceramic surface. Clean and buff with a non abrasive cloth or pad. This will make cleaning easier when soiled from cooking. The special cooktop cleaning cream leaves a protective finish on the glass to help prevent scratches and abrasions.

Sliding aluminum or copper clad bottom pans on the cooktop can cause metal markings on the cooktop surface. These marks should be removed **immediately** after the cooktop has cooled using the cooktop cleaning cream. Metal marks can become permanent if not removed prior to future use.

Cookware (cast iron, metal, ceramic or glass) with rough bottoms can mark or scratch the cooktop surface. **Do not slide anything metal or glass** across the cooktop. **Do not** use your cooktop as a cutting board or work surface in the kitchen. **Do not** cook foods directly on the cooktop surface without a pan. **Do not** drop heavy or hard objects on the glass cooktop, or they may crack it.

⚠ CAUTION Before cleaning the cooktop, be sure the controls are turned to **OFF** and the cooktop is **COOL**.

⚠ WARNING **DO NOT** use a cooktop cleaner on a hot cooktop. The fumes can be hazardous to your health, and can chemically damage the ceramic glass surface.

Cleaning Recommendations for the Ceramic Glass Cooktop

For light to moderate soil:

Apply a few drops of CERAMA BRYTE® Cleaning Creme directly to the cooktop. Use a paper towel or a Multi-Purpose No Scratch Scrub Sponge to clean the entire cooktop surface. Make sure the cooktop is cleaned thoroughly, leaving no residue. Do not use the sponge you use to clean the cooktop for any other purpose.

For heavy, burned on soil:

First, clean the surface as described above. Then, if soils remain, carefully scrape soils with a metal razor blade scraper, holding scraper at a 30 degree angle to the surface. Remove loosened soils with cooktop cleaning cream and buff surface clean.

⚠ CAUTION Damage to the ceramic glass cooktop may occur if you use any scrub pad other than a Multi-Purpose No Scratch Scrub Sponge.

Plastic or foods with a high sugar content:

These types of soils need be removed immediately if spilled or melted onto the ceramic cooktop surface. Permanent damage (such as pitting of the cooktop surface) may occur if not removed **immediately**. After turning the surface elements OFF, use a razor blade scraper or a metal spatula with a mitt and scrape the soil from the hot surface (as illustrated). Allow the cooktop to cool, and use the same method for heavy or burned on soils.

Special Caution for Aluminum Foil and Aluminum Cooking Utensils

- **Aluminum foil**

Use of aluminum foil will damage the cooktop. Do not use under any circumstances.

- **Aluminum utensils**

Since the melting point of aluminum is much lower than that of other metals, care must be taken when aluminum pots or pans are used. Pans that boil dry may permanently damage cooktop by breaking, fusing to, or marking it.

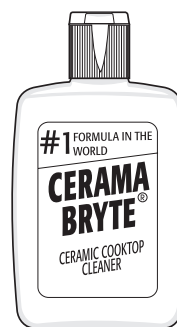

CERAMA BRYTE®
(Cleaner cream for ceramic cooktops)

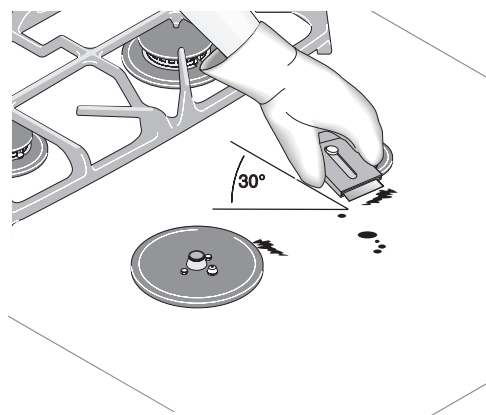

Care & Cleaning



Models with Ceramic Glass Cooktop (Continued)

Do not use the following on the ceramic glass cooktop:

- Do not use abrasive cleaners and scouring pads, such as metal and some nylon pads. They may scratch the cooktop, making it more difficult to clean.
- Do not use harsh cleaners, such as chlorine bleach, ammonia or oven cleaners, as they may etch or discolor the cooktop.
- Do not use dirty sponges, cloths or paper towels, as they can leave soil or lint on the cooktop which can burn and cause discoloration.

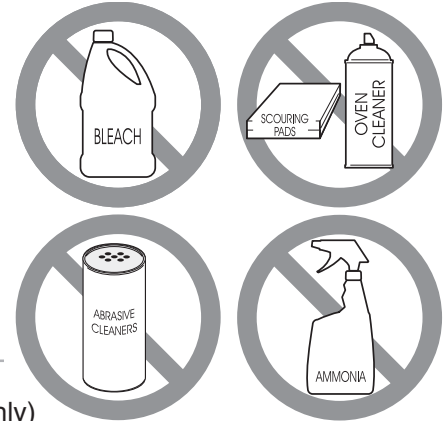

Care and Cleaning of Stainless Steel (Stainless Steel models only)

Some models are equipped with stainless steel exterior parts. Special care and cleaning are **required** for maintaining the appearance of stainless parts. Please refer to the table provided at the beginning of the **General Care & Cleaning** section in this Use & Care Guide.

Before you call Solutions to Common Problems



Before you call for service, review this list. It may save you time and expense. The list includes common occurrences that are not the result of defective workmanship or materials in this appliance.

OCCURRENCE	POSSIBLE CAUSE/SOLUTION
Surface burners do not light.	(1) Surface Control knob has not been completely turned to LITE. Push in and turn the Surface Control knob to LITE until burner ignites and then turn control to desired flame size. (2) Be sure gas supply valve is open. (3) Burner ports or slots are clogged. With the burner off, use a small-gauge wire or needle to clean ports or slots. (4) Power cord is disconnected from outlet (electric ignition models). Be sure cord is plugged securely into outlet. (5) Electrical power outage (electric ignition models). Burners can be lit manually. See Setting Surface Controls in this Owner's Guide.
Surface burner flame burns half way around.	(1) Burner ports or slots are clogged. With the burner off, clean ports with a small-gauge wire or needle to clean ports or slots. (2) Moisture is present after cleaning. Lightly fan the flame and allow burner to operate until flame is full. Dry the burners thoroughly following instructions under General Cleaning .
Surface burner flame is orange.	(1) Dust particles in main line. Allow the burner to operate a few minutes until flame turns blue. (2) In coastal areas, a slightly orange flame is unavoidable due to salt air.
Scratches or abrasion on cooktop surface.	(1) Coarse particles such as salt or sand between cooktop and utensil can cause scratches. Be sure cooktop surface and bottoms of utensils are clean before usage. Small scratches do not affect cooking and will become less visible with time. (2) Cleaning materials not recommended for ceramic-glass cooktop have been used. See "To Clean the Ceramic-glass Cooktop" section under General Cleaning. (3) Cookware with rough bottom has been used. Use smooth, flat-bottomed cookware.
Metalmarks.	(1) Sliding or scraping of metal utensils on cooktop surface. Do not slide metal utensils on cooktop surface. Use ceramic-glass cooktop cleaning cream to remove the marks. See "To Clean the Ceramic-glass Cooktop" section under General Cleaning.
Brown streaks or specks.	(1) Boilover are cooked onto surface. Use razor blade scraper to remove soil. See "To Clean the Ceramic-glass Cooktop" section under General Cleaning.
Areas of discoloration with metallic sheen.	(1) Mineral deposits from water and food. Remove using a ceramic-glass cooktop cleaning cream. Use cookware with clean, dry bottoms.



Major Appliance Warranty Information

Your appliance is covered by a one year limited warranty. For one year from your original date of purchase, Electrolux will pay all costs for repairing or replacing any parts of this appliance that prove to be defective in materials or workmanship when such appliance is installed, used and maintained in accordance with the provided instructions.

Exclusions **This warranty does not cover the following:**

1. Products with original serial numbers that have been removed, altered or cannot be readily determined.
2. Product that has been transferred from its original owner to another party or removed outside the USA or Canada.
3. Rust on the interior or exterior of the unit.
4. Products purchased "as-is" are not covered by this warranty.
5. Food loss due to any refrigerator or freezer failures.
6. Products used in a commercial setting.
7. Service calls which do not involve malfunction or defects in materials or workmanship, or for appliances not in ordinary household use or used other than in accordance with the provided instructions.
8. Service calls to correct the installation of your appliance or to instruct you how to use your appliance.
9. Expenses for making the appliance accessible for servicing, such as removal of trim, cupboards, shelves, etc., which are not a part of the appliance when it is shipped from the factory.
10. Service calls to repair or replace appliance light bulbs, air filters, water filters, other consumables, or knobs, handles, or other cosmetic parts.
11. Surcharges including, but not limited to, any after hour, weekend, or holiday service calls, tolls, ferry trip charges, or mileage expense for service calls to remote areas, including the state of Alaska.
12. Damages to the finish of appliance or home incurred during installation, including but not limited to floors, cabinets, walls, etc.
13. Damages caused by: services performed by unauthorized service companies; use of parts other than genuine Electrolux parts or parts obtained from persons other than authorized service companies; or external causes such as abuse, misuse, inadequate power supply, accidents, fires, or acts of God.

DISCLAIMER OF IMPLIED WARRANTIES; LIMITATION OF REMEDIES

CUSTOMER'S SOLE AND EXCLUSIVE REMEDY UNDER THIS LIMITED WARRANTY SHALL BE PRODUCT REPAIR OR REPLACEMENT AS PROVIDED HEREIN. CLAIMS BASED ON IMPLIED WARRANTIES, INCLUDING WARRANTIES OF MERCHANTABILITY OR FITNESS FOR A PARTICULAR PURPOSE, ARE LIMITED TO ONE YEAR OR THE SHORTEST PERIOD ALLOWED BY LAW, BUT NOT LESS THAN ONE YEAR. ELECTROLUX SHALL NOT BE LIABLE FOR CONSEQUENTIAL OR INCIDENTAL DAMAGES SUCH AS PROPERTY DAMAGE AND INCIDENTAL EXPENSES RESULTING FROM ANY BREACH OF THIS WRITTEN LIMITED WARRANTY OR ANY IMPLIED WARRANTY. SOME STATES AND PROVINCES DO NOT ALLOW THE EXCLUSION OR LIMITATION OF INCIDENTAL OR CONSEQUENTIAL DAMAGES, OR LIMITATIONS ON THE DURATION OF IMPLIED WARRANTIES, SO THESE LIMITATIONS OR EXCLUSIONS MAY NOT APPLY TO YOU. THIS WRITTEN WARRANTY GIVES YOU SPECIFIC LEGAL RIGHTS. YOU MAY ALSO HAVE OTHER RIGHTS THAT VARY FROM STATE TO STATE.

If You Need Service

Keep your receipt, delivery slip, or some other appropriate payment record to establish the warranty period should service be required. If service is performed, it is in your best interest to obtain and keep all receipts. Service under this warranty must be obtained by contacting Electrolux at the addresses or phone numbers below.

This warranty only applies in the USA and Canada. In the USA, your appliance is warranted by Electrolux Major Appliances North America, a division of Electrolux Home Products, Inc. In Canada, your appliance is warranted by Electrolux Canada Corp. Electrolux authorizes no person to change or add to any obligations under this warranty. Obligations for service and parts under this warranty must be performed by Electrolux or an authorized service company. Product features or specifications as described or illustrated are subject to change without notice.

USA
1.800.944.9044
Electrolux Major Appliances
North America
P.O. Box 212378
Augusta, GA 30907



Canada
1.800.668.4606
Electrolux Canada Corp.
5855 Terry Fox Way
Mississauga, Ontario, Canada
L5V 3E4