

FULGOR MILANO

30"-36"-48" Dual Fuel Ranges 600 SERIES

Weight & Dimensions

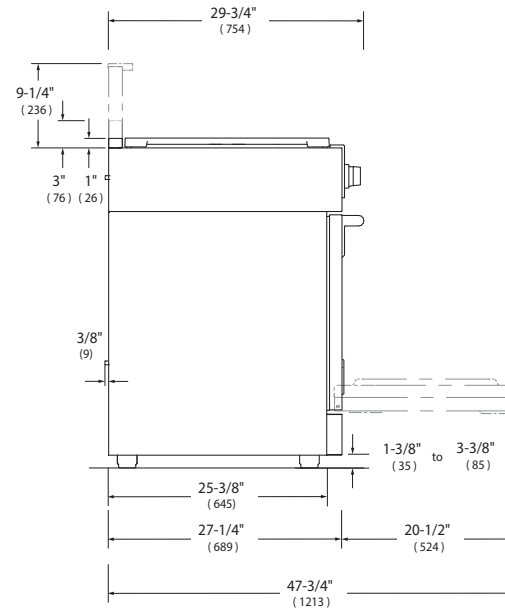
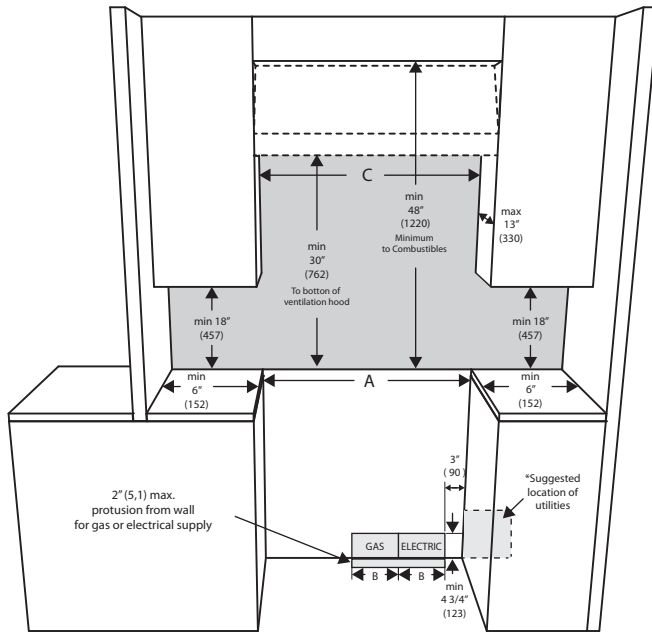

PACKAGING 30"		lb / inch	Kg / mm
GROSS WEIGHT		326 lb	148 Kg
DIMENSION	W	33"	840
	H	45-3/4"	1162
	D	32-1/4"	820

PACKAGING 36"		lb / inch	Kg / mm
GROSS WEIGHT		382 lb	173 Kg
DIMENSION	W	39"	990
	H	45-3/4"	1162
	D	32-1/4"	820

PACKAGING 48"		lb / inch	Kg / mm
GROSS WEIGHT		512 lb	232 Kg
DIMENSION	W	51-1/2"	990
	H	46-1/8"	1173
	D	32-1/4"	820

OPENING WIDTH	A & C	B
Range 30"	30" (762)	6" (152)
Range 36"	36" (914)	7" (178)
Range 48"	48" (1220)	7" (178)

SHADED AREA:
The surface of the entire back wall above the range and below the hood must be covered with a noncombustible material.
*Consult local code for exact location requirements.

Note: Clearances from non-combustible materials are not part of the ANSI Z21.1 scope and not certified. Clearances to non-combustible materials must conform with local codes or, in the absence of local codes, with the National Fuel Gas Code, ANSI Z223.1/NFPA 54.

Minimum clearances:

- Above cooking surface (above 36" [91.4 cm])
 - Sides - 6" (15.2 cm)
 - Within 6" (15.2 cm) side clearance, wall cabinets no deeper than 13" (33.0 cm) must be minimum 18" (45.7 cm) above cooking surface
 - Wall cabinets directly above product must be a minimum of 48" (122 cm) above cooking surface.
 - Rear - 0" with 9" backguard; 0" with non-combustible rear wall.

Below cooking surface (36" [91.4 cm] and below)

- Install with zero clearance between adjacent combustible construction below the cooking surface and the back and sides of the appliance

ADDITIONAL CLEARANCES:

For island installation, maintain 2-1/2 in. minimum from cutout to back edge of countertop and 3 in. minimum from cutout to side edges of countertop (see top view).
For installation in a stepped island, 12" (30.5 cm) minimum clearance is required from the back or sides of the range to a combustible riser. The island installation is not part of the ANSI Z21.1 scope and not certified.

