

OVEN 700 SERIES 30"













CODE ID

30" TOUCH CONTROL DOUBLE OVEN - BLACK GLASS

F7DP30B1



-  **CREACTIVE COOKING SYSTEM**
-  **PIZZA COOKING MODE 590 °F**
-  Dual Convection
-  Self Clean Oven
-  Multi-level cooking
-  1 Telescopic Rack
-  Cool Touch Door
-  TFT Display
-  Meat Probe
-  Fast Pre-Heat
-  Interior Lighting

OVENS

Creative Touch Control System
Dual True Convection
Self-cleaning oven with Multifunction baking
Black Porcelain enamel interior
Cool to the touch
Extra-large baking cavity and viewing area
3 Halogen lights for flawless visibility
Gross capacity 4.4 cu. ft.
2 chromed racks
1 telescopic rack per oven
Enameled Broiler Pan
Lock Keys
Door Lock

OVEN FUNCTIONS

Bake (cooking group)
Broil
Convection (cooking group)
Keep Warm (cooking group)
Recipes
Classic Pizza Function 590°F
Preset default temperature
Preheat (display instantaneous temperature)
Fast Preheat Mode
Sabbath Mode
Setting Temperature °C/°F
Setting Weight Kg/lb
Event Logs (for Service)
Meat Probe (only upper oven)
Self-Clean

OPTIONAL ACCESSORIES

FMTR630 30" Telesc. Rack

SOFIA

30" TOUCH CONTROL DOUBLE OVEN



F7DP30S1
Stainless Steel



F7DP30B1
Black Glass



F7DP30W1
White Glass

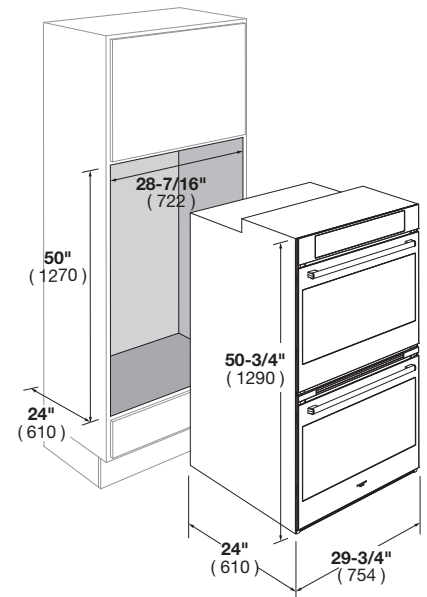

| CODE ID | F7DP30S1 30" TOUCH CONTROL DOUBLE OVEN | F7DP30B1 30" TOUCH CONTROL DOUBLE OVEN | F7DP30W1 30" TOUCH CONTROL DOUBLE OVEN |
|--|--|---|---|
| Series and Finish | 700 Series - Stainless Steel | 700 Series - Black Glass | 700 Series - White Glass |
| CONTROL PANEL | Creative Electronic Touch Control | | |
| Control Type | TFT 3.5" | | |
| Display: Clock - Temperature - Function | English (USA) / English (UK) / French / Spanish / Italian / German | | |
| Language | Control Interface | Chime Volume Setting | |
| | Full Touch: Functions - Recipes | Date Format | |
| | Settings Menu - Brightness Setting | Demo Mode | |
| OVEN | Dual True Convection | | |
| Type | Electronic Control (min/max 170/550°F - 75/290°C) | | |
| Temperature Regulation | | | |
| OVEN FUNCTIONS | Pyrolytic Self-Clean | Broil | |
| | True Convection | Dehydrate | |
| | Convection Broil | Thaw (Defrost) | |
| | Convection Roast | Proof (Warm) | |
| | Pizza (Lower Convection) | Keep warm (Warm Plus) | |
| | Bake | Oven Lights | |
| ELECTRIC OVEN FEATURES | Preset default temperature | Display instantaneous temperature | |
| | Child Door Lock | Control Display Lock | |
| | Sabbath Mode | 12/24 Hour Clock Formats | |
| | Automatic Fast Preheat | Display | |
| | Meat Probe (Upper Oven Only) | Event Logs (for Service) | |
| OVEN DOOR(S) | Large See Through Glass | | |
| Oven Glass Window | 4 Heat Resistant Glasses | | |
| Door Cooling System | Heavy Duty Steady Tilt | | |
| Door Hinges | | | |
| OVEN CAVITY | Gross Capacity (cbft) 4.4 | | |
| Gross Capacity (cbft) | Usable Capacity (cbft) 4.1 | | |
| Usable Capacity (cbft) | Cavity Enamel Colour Black | | |
| Cavity Enamel Colour | 6 Rack Positions | | |
| Rack Positions | 3x20W Halogen Oven Lights | | |
| Oven Lights | | | |
| HEATING ELEMENTS (@240V) | Broil Upper Heating Element 3500 W | | |
| Broil Upper Heating Element | Upper Auxiliary Element 1032 W | | |
| Upper Auxiliary Element | Concealed Bake Lower Heating Element 3000 W | | |
| Concealed Bake Lower Heating Element | Convection Element 2 x 1300 W | | |
| Convection Element | | | |
| OVEN ACCESSORIES | Chromed Racks 2 | | |
| Chromed Racks | Enameled Broiler Pan (basin + anti splash) 1 | | |
| Enameled Broiler Pan (basin + anti splash) | Telescopic Chromed Rack 1 | | |
| Telescopic Chromed Rack | | | |
| DIMENSIONS/WEIGHT | Overall dim - Width 29 - 11/16" (754 mm) | | |
| Overall dim - Width | Overall dim - Height 50 - 13/16" (1290 mm) | | |
| Overall dim - Height | Overall dim - Depth 24" (610 mm) | | |
| Overall dim - Depth | Cut-out - Width 28 - 7/16" (722 mm) | | |
| Cut-out - Width | Cut-out - Height (min) 50" (1270 mm) | | |
| Cut-out - Height (min) | Cut-out - Depth (min) 23 - 1/4" (590 mm) | | |
| Cut-out - Depth (min) | Gross Weight 326 lbs (148 kg) | | |
| Gross Weight | | | |
| POWER / RATINGS (208/240 V, 60 HZ) | kW / Amps rating at 120-240V, 60Hz 7.50kW - 31.2A | | |
| kW / Amps rating at 120-240V, 60Hz | kW / Amps rating at 120-208V, 60Hz 6.30kW - 30.3A | | |
| kW / Amps rating at 120-208V, 60Hz | Power Cable Conduit | | |
| Power Cable | | | |
| INSTRUCTIONS FOR USE | Use & Care Manual / Installation Manual English / French / Spanish | | |
| Use & Care Manual / Installation Manual | | | |