

OVEN 700 SERIES 30"













CODE ID

30" TOUCH CONTROL DOUBLE OVEN - WHITE GLASS

F7DP30W1



-  **CREACTIVE COOKING SYSTEM**
-  **PIZZA COOKING MODE 590 °F**
-  Dual Convection
-  Self Clean Oven
-  Multi-level cooking
-  1 Telescopic Rack
-  Cool Touch Door
-  TFT Display
-  Meat Probe
-  Fast Pre-Heat
-  Interior Lighting

OVENS

Creative Touch Control System
Dual True Convection
Self-cleaning oven with Multifunction baking
Black Porcelain enamel interior
Cool to the touch
Extra-large baking cavity and viewing area
3 Halogen lights for flawless visibility
Gross capacity 4.4 cu. ft.
2 chromed racks
1 telescopic rack per oven
Enameled Broiler Pan
Lock Keys
Door Lock

OVEN FUNCTIONS

Bake (cooking group)
Broil
Convection (cooking group)
Keep Warm (cooking group)
Recipes
Classic Pizza Function 590°F
Preset default temperature
Preheat (display instantaneous temperature)
Fast Preheat Mode
Sabbath Mode
Setting Temperature °C/°F
Setting Weight Kg/lb
Event Logs (for Service)
Meat Probe (only upper oven)
Self-Clean

OPTIONAL ACCESSORIES

FMTR630 30" Telesc. Rack

SOFIA

30" TOUCH CONTROL DOUBLE OVEN



F7DP30S1
Stainless Steel



F7DP30B1
Black Glass



F7DP30W1
White Glass

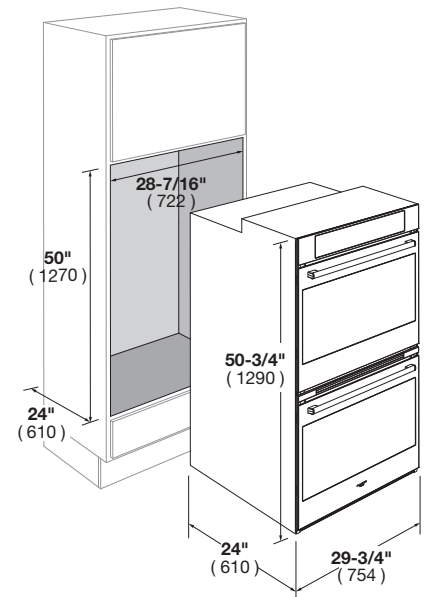

CODE ID	F7DP30S1 30" TOUCH CONTROL DOUBLE OVEN	F7DP30B1 30" TOUCH CONTROL DOUBLE OVEN	F7DP30W1 30" TOUCH CONTROL DOUBLE OVEN
Series and Finish	700 Series - Stainless Steel	700 Series - Black Glass	700 Series - White Glass
CONTROL PANEL	Creative Electronic Touch Control		
Control Type	TFT 3.5"		
Display: Clock - Temperature - Function	English (USA) / English (UK) / French / Spanish / Italian / German		
Language	Control Interface	Chime Volume Setting	
	Full Touch: Functions - Recipes	Date Format	
	Settings Menu - Brightness Setting	Demo Mode	
OVEN	Dual True Convection		
Type	Electronic Control (min/max 170/550°F - 75/290°C)		
Temperature Regulation			
OVEN FUNCTIONS	Pyrolytic Self-Clean	Broil	
	True Convection	Dehydrate	
	Convection Broil	Thaw (Defrost)	
	Convection Roast	Proof (Warm)	
	Pizza (Lower Convection)	Keep warm (Warm Plus)	
	Bake	Oven Lights	
ELECTRIC OVEN FEATURES	Preset default temperature	Display instantaneous temperature	
	Child Door Lock	Control Display Lock	
	Sabbath Mode	12/24 Hour Clock Formats	
	Automatic Fast Preheat	Display	
	Meat Probe (Upper Oven Only)	Event Logs (for Service)	
OVEN DOOR(S)	Large See Through Glass		
Oven Glass Window	4 Heat Resistant Glasses		
Door Cooling System	Heavy Duty Steady Tilt		
Door Hinges			
OVEN CAVITY	Gross Capacity (cbft) 4.4		
Gross Capacity (cbft)	Usable Capacity (cbft) 4.1		
Usable Capacity (cbft)	Cavity Enamel Colour Black		
Cavity Enamel Colour	6 Rack Positions		
Rack Positions	3x20W Halogen Oven Lights		
Oven Lights			
HEATING ELEMENTS (@240V)	Broil Upper Heating Element 3500 W		
Broil Upper Heating Element	Upper Auxiliary Element 1032 W		
Upper Auxiliary Element	Concealed Bake Lower Heating Element 3000 W		
Concealed Bake Lower Heating Element	Convection Element 2 x 1300 W		
Convection Element			
OVEN ACCESSORIES	2 Chromed Racks		
Chromed Racks	1 Enameled Broiler Pan (basin + anti splash)		
Enameled Broiler Pan (basin + anti splash)	1 Telescopic Chromed Rack		
Telescopic Chromed Rack			
DIMENSIONS/WEIGHT	Overall dim - Width 29 - 11/16" (754 mm)		
Overall dim - Width	Overall dim - Height 50 - 13/16" (1290 mm)		
Overall dim - Height	Overall dim - Depth 24" (610 mm)		
Overall dim - Depth	Cut-out - Width 28 - 7/16" (722 mm)		
Cut-out - Width	Cut-out - Height (min) 50" (1270 mm)		
Cut-out - Height (min)	Cut-out - Depth (min) 23 - 1/4" (590 mm)		
Cut-out - Depth (min)	Gross Weight 326 lbs (148 kg)		
Gross Weight			
POWER / RATINGS (208/240 V, 60 HZ)	kW / Amps rating at 120-240V, 60Hz 7.50kW - 31.2A		
kW / Amps rating at 120-240V, 60Hz	kW / Amps rating at 120-208V, 60Hz 6.30kW - 30.3A		
kW / Amps rating at 120-208V, 60Hz	Power Cable Conduit		
Power Cable			
INSTRUCTIONS FOR USE	Use & Care Manual / Installation Manual English / French / Spanish		
Use & Care Manual / Installation Manual			