







SOFIA PROFESSIONAL 30"

30" PROFESSIONAL WARMING DRAWER - STAINLESS STEEL

CODE ID

F6PWD30S1



-  Sliding Telescopic Rails
-  Keep Warm Function
-  Leavening
-  Slow Cooking
-  Thawing
-  Soft Closing



COLOR KIT

	STAINLESS STEEL
	MATTE BLACK RAL 9004
	GLOSSY BLACK RAL 9004
	GLOSSY RED RAL 3003
	GLOSSY WHITE RAL 9016
	MATTE WHITE RAL 9016
	MATTE GREY RAL 9007

WARMING DRAWER 30"

Knob Control
Heavy Duty full extendable telescopic rails
Large capacity 2,1 cu. ft.
Convection heating system for even heat distribution
All stainless steel structure
Warming Temperature range; min. 86 °F up to 190 °F
Slow closing assistance
2 Internal lights
Non-slip rubber mat

DRAWER 30" FUNCTIONS

Pre-heat dishes
Pre-heat coffee cups
Keep warm ready food
Defrosting
Leavening dough
Slow cooking min. 86 °F up to 190 °F

OPTIONAL ACCESSORIES

PWDKIT30 ... Colour kit

SOFIA

30" PROFESSIONAL WARMING DRAWER

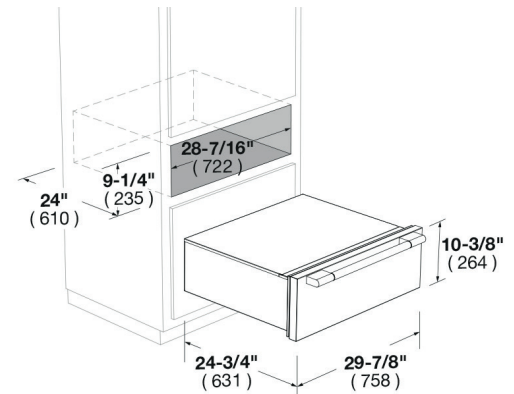

CODE ID	F6PWD30S1 - 30" PROFESSIONAL WARMING DRAWER	
Type	Warming Drawer	
Front finish	Stainless Steel with Pro - Handle	
Internal shelf	Inox	
Compatible with ovens	F6PSP30S1 - F6PDP30S1	
PERFORMANCE		
Maximum temperature	194°F / 90°C	
Cooking at low temperature (slow cooking)	•	
Leavening	•	
Heating dishes and food	•	
Slow close assistance	•	
Open / Close push - pull system	-	
CONTROL		
Thermostat	86°F - 194°F / 30°C - 90°C	
Fan assisted	•	
Function Indicator / Thermostat on/off	•	
SAFETY		
Safety front	•	
ELECTRICAL SPECIFICATIONS		
Max power absorbed (W)	1100W	
Power (V-Hz)	120/60	
Power cord	•	
Plug	•	
CAPACITY		
Volume (cbft-litri)	2,1	61.4
DIMENSIONS		
Overall dim - Width	29 7/8"	(758 mm)
Overall dim - Height	10 3/8"	(264 mm)
Overall dim - Depth	23"	(583 mm)
Door Depth with Overlay	2 1/8"	(54 mm)
Door Depth with Pro Handle	4 11/16"	(119 mm)
Cut-out - Width	28 7/16"	(722 mm)
Cut-out - Height	9 1/4"	(235 mm)
Cut-out - Depth	24"	(610 mm)
WEIGHT		
Net Weight	68.5 lbs	31.0 Kg
Gross Weight	75.2 lbs	34.1 Kg