

# 36" FRENCH DOOR FRIDGE









CODE ID

36" FRENCH DOOR FRIDGE SHOWN WITH PRO HANDLE KIT

**F6FBM36S2**



-  Fingerprint-Proof Stainless Steel
-  ION Fresh
-  LED Lighting
-  Ice Maker
-  Total No Frost
-  Holiday Mode

## NOTE:

Pro Handle Kit sold separately.

The Fulgor Milano badge, included in the Pro Handle Kit, is optional and its position can be decided by the installer or by the customer.

F6FBM36S2                      French Door Fridge  
F6HK36FFBS                      Pro Handle Kit



## SPECIFICATIONS

### FRIDGE

Duo Cycling Cooling  
Ion Fresh  
Inner Digital Display  
Sabbath Mode  
Large Pantry Drawer  
Height Adjustable Cantilever Shelves  
Interior Filtered Water Dispenser  
Interior Theatre Lighting with LED lights

### FREEZER FEATURES

Automatic Ice Machine  
Large Freezer Drawer

## REQUIRED ACCESSORIES

F6HK36FFBS  
Sofia French Door Pro Handle Kit

# 36" FRENCH DOOR

FRENCH DOOR WITH PRO HANDLE KIT

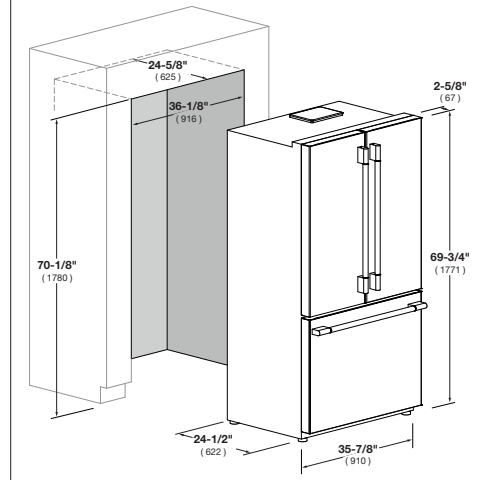

CODE ID	36" FRENCH DOOR + PROFESSIONAL HANDLE KIT F6FBM36S2 + F6HK36FFBS
Finish	Stainless Steel
<b>CONTROLS</b>	
Cooling System	Duo Frost Free Cooling
Control system	Electronic System
<b>CAPACITIES</b>	
Total Net Volume, cu. ft.	19.86
Fresh Food Net Volume, cu. ft.	13.3
Freezer Net Volume, cu. ft.	6.56
<b>FRIDGE FEATURES</b>	
IonFresh	•
Carbon Filter	•
Interior Filtered Water Dispenser	•
Electronic Control Display Type	Hidden Digital Display on Front Top Trim
Auto Defrost	•
Inner Illumination	Side Walls, Ceiling and Fresh Food Compartment
Shelves	4 Safety Glass
Crispers	2
Door Racks	6
Compressor	Variable Speed VCC
Large Pantry Drawer	•
Fan Ventilation	•
<b>FREEZER FEATURES</b>	
Automatic Ice Maker	•
Auto Defrost	•
Interior LED Lighting	Ceiling
<b>TECHNICAL FEATURES</b>	
Supply Voltage, V/Hz	120V / 60Hz
Rated Current, A	2.2A
Noise Level, dBA	44
<b>DIMENSIONS</b>	
H x W x D, in.	69 - 3/4" x 35 - 3/4" x 26 - 13/16"
H x W x D, cm	177.1 x 90.8 x 68
Product Weight, lbs.	289 lbs
Product Weight, kg	135 Kg
<b>PERFORMANCE</b>	
Energy Star Qualified	•
Climatic Class	T
Annual Energy Consumption, wh/year	566
Cooling Gas	R134
<b>INSTRUCTIONS FOR USE</b>	
Use & Care Manual / Installation Manual	English / French / Spanish