

SOFIA PROFESSIONAL 30"







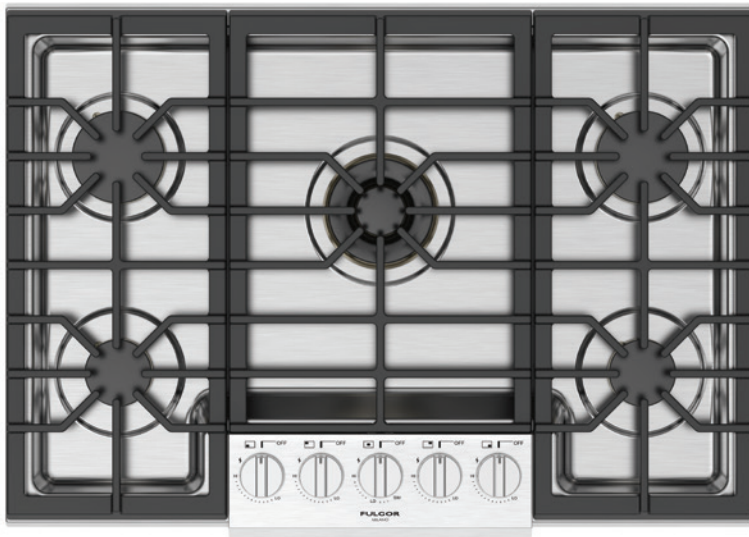

CODE ID

30" PROFESSIONAL PRO GAS COOK TOP

F6PGK305S1



-  Knob control with back light system
-  1 Center Dual Burner
-  4 Single Burners
-  Heavy Duty Grates
-  Continuous Grate Surface
-  Heavy Duty Control Panel



COOKING SURFACE

- 3 Heavy duty continuous cast iron grates
- Heavy Gauge 304 Stainless Steel Burner Bowl
- 1 Solid Brass Dual Flame Burner with 20.000 BTU Max (NG)
- 2 Solid Brass Rapid Burners with 10.500 BTU Max (NG)
- 2 Solid Brass Semirapid Burners with 8.000 BTU Max (NG)
- Backlit Control Knob indicates burner operation (White)
- Backlit Control Knob indicates residual heat (Red)
- Heavy duty control panel
- Large cooking area
- Full pot stability
- Natural Gas (LP Convertible)

OPTIONAL ACCESSORIES

- FMWOK Wok ring
- FMSIM Simmer plate

NOTE:

Wok ring (FMWOK) to be used with centre burner only.

SOFIA

30" PROFESSIONAL PRO GAS COOK TOP

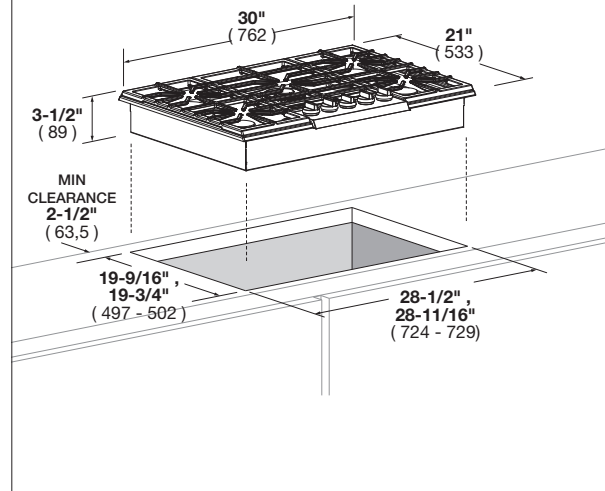
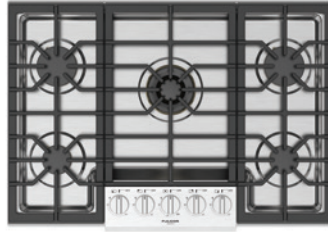

CODE ID	F6PGK305S1 - 30" PROFESSIONAL PRO GAS COOK TOP	
Series and Finish	600 Series - Stainless Steel	
CONTROL PANEL		
Control Type	Knobs	
COOKTOP		
Type	GAS (NG or LP)	
Cooking Surface	Matte Black Enamel	
GAS COOKTOP FEATURES		
Electric Re-ignition system	•	
Flame-out sensing	•	
Dual Crown Brass Burner	•	
Simmer Plate	Optional	
Small Pot Insert (for single burners only)	Optional	
Wok Ring (for dual burner only)	Optional	
Heavy Duty Cast Iron Grates	2	
Cooking Zones	5	
Burners types	All Brass Dual Flame/Simmer Burner	
Power (Max/Min) (Front-L)	8000 (BTU/h) - 2345W / 1300 (BTU/h) - 382W	
Power (Max/Min) (Rear-L)	10500 (BTU/h) - 3080W / 2200 (BTU/h) - 645W	
Power (Max/Min) (Center)	20000 (BTU/h) - 5880W / 750 (BTU/h) - 220W	
Power (Max/Min) (Rear-R)	10500 (BTU/h) - 3080W / 2200 (BTU/h) - 645W	
Power (Max/Min) (Front-R)	8000 (BTU/h) - 2345W / 1300 (BTU/h) - 382W	
DIMENSIONS/WEIGHT		
Overall dim - Width	30"	(762 mm)
Overall dim - Height	4 - 5/8"	(118 mm)
Overall dim - Depth	21"	(533 mm)
Cut-out - Width (min - max)	28" - 1/2 , 28" - 11/16	(724 mm) - (729 mm)
Cut-out - Height (min)	3 - 3/8"	(87 mm)
Cut-out - Depth (min - max)	19" - 9/16 , 19" - 3/4	(497 mm) - (502 mm)
Gross Weight	61 lbs	(27.5 kg)
POWER / RATINGS (120 V, 60 HZ)		
Amps	0.1A	
Max Power	57000 (BTU/h) - 16730W	
Power Cable	Nema 5-15P	
INSTRUCTIONS FOR USE		
Use & Care Manual / Installation Manual	English / French / Spanish	