



FULGOR
MILANO

SINCE
PASSIONE | ITALIANA
1949

FULGOR

MILANO

PROFESSIONAL

PROFESSIONAL	pag 12
COOKING	pag 24
HOODS	pag 54
FRIDGE	pag 64
CLEAN	pag 72
ACCESSORIES	pag 74

DISTINTO

DISTINTO	pag 88
COOKING	pag 92
HOODS	pag 142
FRIDGE	pag 150
CLEAN	pag 156
ACCESSORIES	pag 162

TECHNICAL

DWG	pag 168
DATA	pag 187





FULGOR
MILANO

DESIGN OF MILANO



Milano is renowned the world over as the center of style and design. At Fulgor Milano we are inspired by this great city and its rich history of combining form and function with architecture. It is from this city which Sofia is born.

Sofia embodies a styling that is all her own, with an attention to detail and design that is unsurpassed in the industry. As it is with the Cathedral of Milano, our Sofia range stands out in a crowd. Drawing inspiration from the modern

cosmopolitan city of today, Fulgor Milano brings modern technology to the kitchen and is continuously seeking innovative solutions for our customers to allow them to achieve the best cooking experience imaginable.



FULGOR
MILANO

POWER

OF ROMA



Not unlike the incredible eternal city of Roma, our Sofia products are designed to stand the test of time. A product that embodies endurance and is built on a tradition of beauty, durability, and functionality.

Roma has survived over two Millennia through evolution of design and innovation.

Fulgor Milano's passion for innovation has resulted in premium products born from a culinary culture dating back to ancient

Roma but in synergy with today's lifestyle. Every one of our Sofia products has been developed to offer a lifetime of performance in an ergonomic and comfortable design that is both elegant and simple to use.



FULGOR
MILANO

GUSTO OF FIRENZE

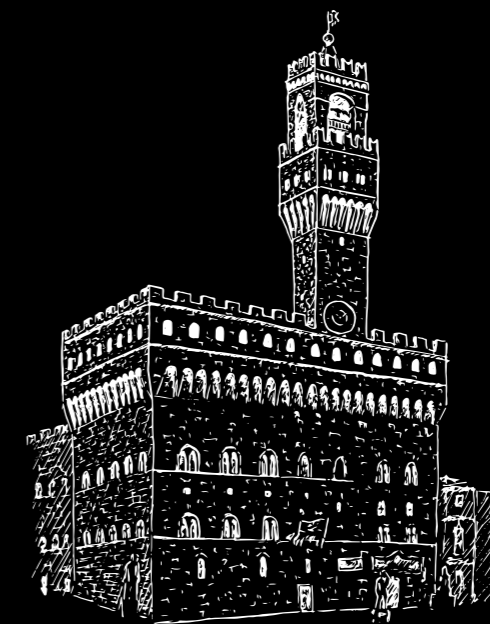

As the kitchen has once again become the center of the home over the past decade, Fulgor Milano understands our desire to incorporate appliances that meet the needs of both form and function. There are few places in the world that can boast a rich history of form, function, art and

design. Florence was the birth place of the renaissance, where Michelangelo and Leonard da Vinci sculpted and painted forms in perfect balance. It was during this renaissance that the art of cooking was born. Florence would become the birth place of gastronomy and was

the culinary center of the modern world at that time. Fulgor Milano has endeavored to incorporate all of these aspects into their cooking products. Drawing further inspiration from this great city and blending a perfect balance of quality, design and performance into every product.



FULGOR
MILANO

UNIQUE

LIKE VENEZIA



There is not a more unique city in the world than Venice. A city that by modern engineering standards should not exist. A city built on the sea, that has inspired generations of visitors for centuries.

The original gateway to the east, Venice is a city whose architecture incorporates design aspects from the middle east and Asia, adding to its unique appeal. No other place influences the styling of Sofia more than Venice.

Sofia's designer, having attended the school of Architecture at the University of Venice, drew his inspiration during this time in Venice. It is only fitting that this unique city influenced the unique design of our beautiful Sofia range.



FULGOR
MILANO

SOFIA

PROFESSIONAL

SCOPRI IL PROFILO ITALIANO DI SOFIA

DESIGN

POWER

GUSTO

UNIQUE

Sofia represents the beauty and sophistication that is Italy and the Meneghetti Family has paid tribute to all the unique cultural aspect of this storied country with Sofia and the complete

line of Fulgor Milano products. Inspired by all the great regions of Italy, Sofia was born in the heart of the Veneto region, culturally rich in art and tradition. Sofia embodies a contemporary

design that is feminine and powerful, which inspires us to prepare dishes worthy of admiration. The Meneghetti Family has presented us with a symbol of the ultimate expression of Italian excellence.

PROFESSIONAL LINE



SOFIA

PROFESSIONAL



CLASSIC BEAUTY

Sofia is a solid, generously sized freestanding range with a clean and rigorous style. Designed, developed and engineered in Italy to exceed all expectations of quality, performance and style. Sofia will captivate the most discerning chef with nuanced features that are traditional yet innovative.

SOFIA PROFESSIONAL

FULGOR
MILANO



SOFIA IS AN INDIVIDUAL

We designed a professional range with a style and presence unique to her name. Sofia integrates the use of stainless and brushed aluminum for a design that is elegant and distinctive.

TOTAL CONTROL AND DELICATE POWER

Every aspect of Sofia is beautiful and her gas cooking surface is no exception. Every burner allows you to temper the most delicate chocolate or sear a steak to perfection.

TOTAL ACCESS AT YOUR FINGER TIPS

Choose multiple baking functions, timed bake, meat probe, and a variety of other customizable settings and baking features.

PROFESSIONALLY CRAFTED

This multifunction range, combines all the features of a fully-equipped professional range with a stainless steel design which highlights the elegance and uniqueness of Italian style.



TRILAMINATE GRIDDLE

As if 6 powerful burners wasn't enough, the addition of a Trilaminate griddle allows additional versatility to the cooking surface. With 12,500 BTU's of even heat, Sofia sears with conviction and the easy to care for surface will be beautiful for its entire lifetime.

CAST IRON GRATES AND MATTE BURNER BASIN

Heavy duty cast iron grates form a continuous surface for easy movement of pots and pans. You'll barely notice spillovers in this recessed burner basin and they'll clean up easily, too.

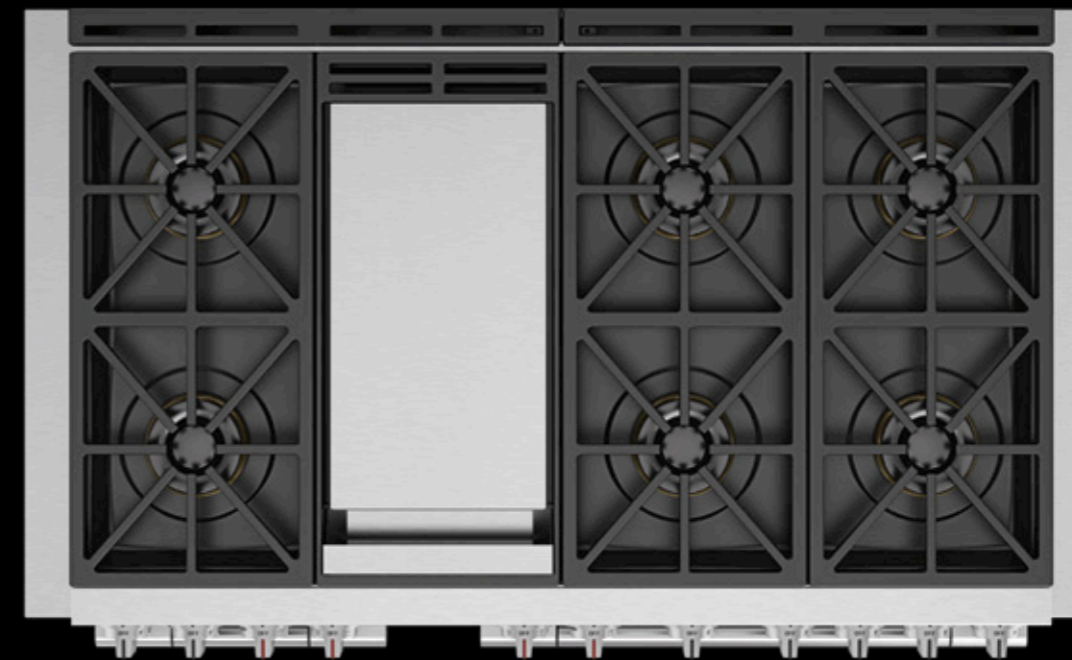

DUAL BURNER WITH BRASS BURNER RING

For perfect control, easy cleaning, and lasting performance, the brass burner ring and the precision flame ports remain corrosion free.

ROBUST CONTROL KNOBS

A perfect match for the bold design of the control panel, robust brushed metal knobs ensure easy handling and precise control while cooking.

FULGOR
MILANO

5 in 1

CRESCENDO BURNER

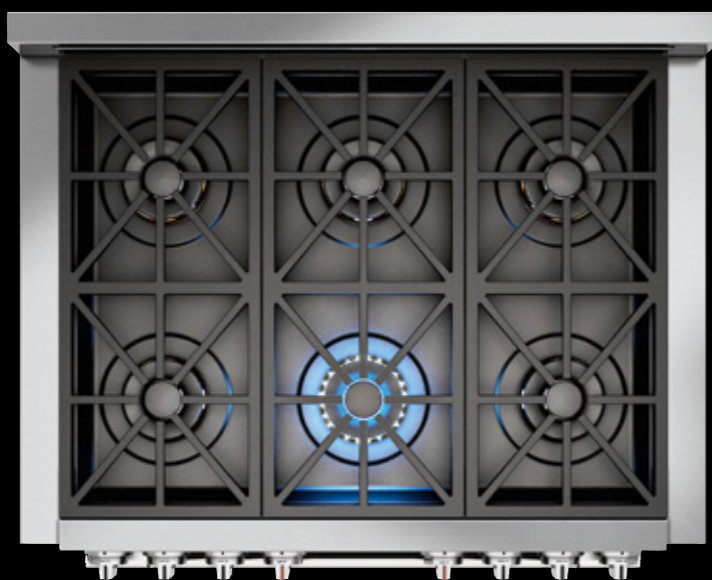

Because precision is important for powerful high and gentle low flames, our sealed burners offer five combinations of flame configurations for near infinite control. Durable brass burner rings provide exceptional heat distribution to the base of the cooking vessel at its maximum output of 20,000 BTU and is also capable of the gentlest simmer aided by its oversized burner cap.



FORTE

1

At the peak of its 20,000 BTU capability, meat is seared to produce a crust worthy of your favorite chef. Large pots quickly recover to a rigorous boil, and no culinary conquest seems unattainable. All burner rings engage to produce the most powerful flame for cooking.



MEZZOFORTE

2

Perfect al dente pasta is a snap. Progressive control of the burner ensures maximum heat distribution without excessive flame for an even and moderate boil.



MEZZO

3

Creamy risotto and smooth custards come to life as the burner rings combine to provide enough heat to encourage the cooking but discourage scorching.



PIANOFORTE

4

Simmer, poach, or braise your way to a tender sauce, soup or stew. Flame curls around the diffuser cap to barely brush the base of the cooking vessel with perfect control for extended periods of low heat cooking.



PIANO

5

Melt butter, temper chocolate, or gently coax the flavor from savory vegetables, this lowest setting is achieved by the flame from the simmer burner rolling gently under the diffuser cap to radiate whisper soft heat.



AUTOGRAPH YOUR KITCHEN

MAKE IT EXCLUSIVELY YOURS!

Customize your Sofia kitchen with your name of a chosen. Visit the Fulgor Milano website to create your personalized name plate for the oven door. The complimentary plate will be delivered to your home where your unique Sofia kitchen is exclusively yours.



NEW

48" DUAL FUEL PROFESSIONAL RANGE

THE ART OF COOKING EXPANDED

FULGOR
MILANO

Thoughtfully designed surface cooking with six burner positions, each with a 5 in 1 Crescendo burner beneath continuous cast iron grates and a Trilaminare Stainless Steel griddle, providing unparalleled power and control to melt, simmer, saute, and sear as you desire. Below the cooking surface, two self cleaning convection ovens with intuitive multiple baking and broiling functions and the convenience of telescoping racks encourages you to cook the way you want.



48" DUAL FUEL

PROFESSIONAL RANGE CHARACTERISTICS

TRILAMINATE GRIDDLE

Functional and beautiful with layers of two unique types of stainless steel for durability and easy cleaning form a three layer griddle with the addition of aluminum for even and consistent heat distribution.

UNSURPASSED CRAFTSMANSHIP

Superior Italian steelmaking craftsmanship ensures perfectly polished edges and smooth corners, concealing screws and welds for an impeccable finish.

COOL TOUCH DOOR

4 layers of thermo-reflecting glass ensure the safety of a cool touch door while the oven is on - even at its highest temperature during the self-clean cycle.

CONVENIENCE OVEN

Identically featured as its larger mate, but without meat probe, this self-cleaning, multi function convection oven does everything in a smaller space, adding efficiency and flexibility. It even has a telescopic rack.



CAST IRON GRATES

Built to withstand searing heat and rapid temperature changes without losing their strength, continuous cast iron grates allow pans to be easily repositioned at your convenience.

SIX BURNERS

6 cooking zones, each with Crescendo burners create 5 levels of cooking power. At each level, the perfect combination of power and even distribution of heat allows precise results from temper to sear at 20,000 BTU. A combination of burner rings at different levels controls the relation of the flame to the bottom of the cooking vessel, allowing whisper soft heat for melting or rendering to ultra high searing and deglazing.

DUAL OVENS

Two self-cleaning convection ovens with multiple baking functions allow for ultimate flexibility, performance and capacity. Telescopic chrome oven racks allow for convenient inspection of dishes during cooking and effortless removal when done.

SOFT CLOSING DOOR

Robust stainless oven doors with wide viewing windows get an assist from shock absorbing hinges, facilitating an effortless soft closing oven.

SPECIAL TRILAMINATE STAINLESS STEEL GRIDDLE

The ultimate in performance and beauty, heat is evenly and uniformly distributed across the griddle surface allowing for golden pancakes, perfectly crusted steaks, and everything in between. With an easy to clean surface, the griddle resists discoloration at even the highest temperatures to remain unaffected for years to come.

GRIDDLE BURNER

12,500 BTU tubular aluminum burner with evenly distributed flame ports conducts heat to the griddle for optimal performance at maximum power. 4,200 BTUs at low power for more delicate foods. Sear a steak or make a golden griddle cake with ease.

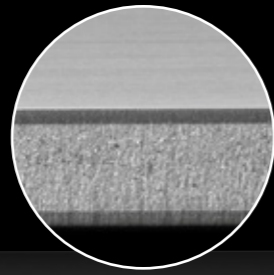

3 METAL LAYERS GRIDDLE

1 SURGICAL STAINLESS STEEL

Provides unrelenting protection against corrosion, pitting, and discoloration, this non-reactive surgical grade stainless ensures easy cleaning and durability.

2 ALUMINUM

Allows for even heat distribution across the entire grilling surface from edge to edge for precise cooking and consistent browning.

3 STAINLESS STEEL

Establishes a stable and rigid foundation for a consistently flat and enduring direct cooking surface.



SOFIA PROFESSIONAL 48"

48" DUAL FUEL PROFESSIONAL RANGE

NEW



CODE ID



F6PDF486GS1



Heavy Duty Grates



Continuous Grate Surface



Dual Crescendo Burner



Trilaminated Stainless Steel Griddle



Dual Convection (main oven)



True Convection (accessory oven)



Soft Closing Door



Self Clean Ovens



Multi-level cooking



1 Telescopic Rack



Cool Touch Door



Digital Controls



Meat Probe (main oven)



Fast Pre-Heat

OPTIONAL ACCESSORIES

pag

PDRKIT48 ...	Colour kit	80
FMWOK	Wok ring	83
FMSIM	Simmer plate	83
F6BG48BCI	Island trim	83
F6BG48STD	Standard trim	82
F6BG48HBT	High back trim	82
FMTRP30	Telescopic rack	84
FMTRP18	Telescopic rack	84
FMGRIDCOV48	Griddle Cover	83

TECHNICAL DWG

170

TECHNICAL DATA

188

SPECIFICATIONS

COOKING SURFACE

3 Heavy Duty, continuous cast iron grates
Trilaminated Stainless Steel Griddle with
Tubular Gas Burner
12,500 BTU high / 4,200 BTU low
Matte finish porcelain burner bowl
6 Dual-Flame Crescendo Burners
2 X 20,000 BTU max (NG)
4 X 18,000 BTU max (NG)
Natural Gas (LP convertible)

OVENS

Dual True Convection in main oven and
True Convection in accessory oven
Self-cleaning oven with Multifunction baking
Black Porcelain enamel interior
Cool to the touch, soft closing door
Extra-large baking cavity and viewing area
3 Halogen lights on main oven
1 Halogen light on convenience oven
Gross capacity 4.4 cu. ft. and 2.7 cu. ft.
2 chromed racks
1 telescopic rack per oven

OVEN FUNCTIONS

Bake
Broil
Roast
Convection
True Convection
Warm / Proof / Dehydrate
Electronic cooking programmer
Meat Probe on main oven only
Self-Clean
Sabbath Mode

SOFIA PROFESSIONAL 36"













36" DUAL FUEL PROFESSIONAL RANGE



CODE ID



F6PDF366S1

-  Heavy Duty Grates
-  Continuous Grate Surface
-  Dual Crescendo Burner
-  Dual Convection
-  Soft Closing Door
-  Self Clean Oven
-  Multi-level cooking
-  1 Telescopic Rack
-  Cool Touch Door
-  Digital Controls
-  Meat Probe
-  Fast Pre-Heat

OPTIONAL ACCESSORIES pag

PDRKIT36 ...	Colour kit	81
FMWOK	Wok ring	83
FMSIM	Simmer plate	83
F6BG30BCI	Island trim	83
F6BG36STD	Standard trim	82
F6BG36HBT	High back trim	82
FMGRID36	Griddle	83
FMTRP36	Telescopic rack	84

TECHNICAL DWG 171

TECHNICAL DATA 189

SPECIFICATIONS

COOKING SURFACE

3 Heavy Duty, continuous cast iron grates
One piece, matte finish porcelain burner bowl
6 Dual-Flame Crescendo Burners
2 X 20,000 BTU max (NG)
4 X 18,000 BTU max (NG)
Natural Gas (LP convertible)

OVEN

Dual True Convection
Self-cleaning oven with Multifunction baking
Black Porcelain enamel interior
Cool to the touch, soft closing door
Extra-large baking cavity and viewing area
3 Halogen lights for flawless visibility
Gross capacity 5.7 cu. ft.
2 chromed racks
1 telescopic rack
Enameled Broiler Pan

OVEN FUNCTIONS

Bake
Broil
Roast
Convection
True Convection
Warm / Proof / Dehydrate
Electronic cooking programmer
Meat Probe
Self-Clean
Sabbath Mode

SOFIA PROFESSIONAL 30"













30" DUAL FUEL PROFESSIONAL RANGE



CODE ID



F6PDF304S1

-  Heavy Duty Grates
-  Continuous Grate Surface
-  Dual Crescendo Burner
-  Dual Convection
-  Soft Closing Door
-  Self Clean Oven
-  Multi-level cooking
-  1 Telescopic Rack
-  Cool Touch Door
-  Digital Controls
-  Meat Probe
-  Fast Pre-Heat

OPTIONAL ACCESSORIES pag

PDRKIT36 ...	Colour kit	81
FMWOK	Wok ring	83
FMSIM	Simmer plate	83
F6BG30BCI	Island trim	83
F6BG30STD	Standard trim	82
F6BG30HBT	High back trim	82
FMGRID30	Griddle	83
FMTRP30	Telescopic rack	84

TECHNICAL DWG 171

TECHNICAL DATA 189

SPECIFICATIONS

COOKING SURFACE

2 Heavy Duty, continuous cast iron grates
One piece, matte finish porcelain burner bowl
4 Dual-Flame Crescendo Burners
1 X 20,000 BTU max (NG)
3 X 18,000 BTU max (NG)
Natural Gas (LP convertible)

OVEN

Dual True Convection
Self-cleaning oven with Multifunction baking
Black Porcelain enamel interior
Cool to touch, soft closing door
Extra-large baking cavity and viewing area
3 Halogen lights for flawless visibility
Gross capacity 4.4 cu. ft.
2 chromed racks
1 telescopic rack
Enameled Broiler Pan

OVEN FUNCTIONS

Bake
Broil
Roast
Convection
True Convection
Warm / Proof / Dehydrate
Electronic cooking programmer
Fast Pre-Heat
Self-Clean
Sabbath Mode

SOFIA PROFESSIONAL 36"

36" ALL GAS PROFESSIONAL RANGE



CODE ID



F6PGR366S2

- Heavy Duty Grates
- Continuous Grate Surface
- Dual Crescendo Burner
- Dual Convection
- Soft Closing Door
- Cool Touch Door
- Multi-level cooking
- 1 Telescopic Rack
- Digital Controls
- Nova Broiler System

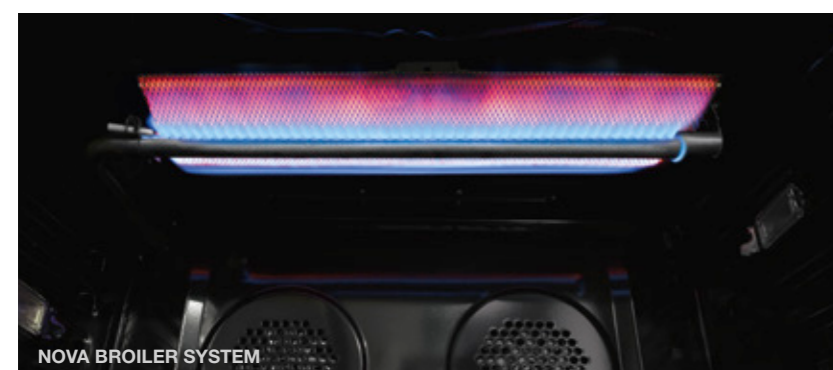

OPTIONAL ACCESSORIES pag

PDRKIT36 ...	Colour kit	81
FMWOK	Wok ring	83
FMSIM	Simmer plate	83
F6BG30BCI	Island trim	83
F6BG36STD	Standard trim	82
F6BG36HBT	High back trim	82
FMGRID36	Griddle	83
FMTRP36	Telescopic rack	84

TECHNICAL DWG	171
TECHNICAL DATA	190

SPECIFICATIONS

COOKING SURFACE

3 Heavy Duty, continuous cast iron grates
 One piece, matte finish porcelain burner bowl
 6 Dual-Flame Crescendo Burners
 2 X 20,000 BTU max (NG)
 4 X 18,000 BTU max (NG)
 Natural Gas (LP convertible)

NEW NOVA BROILER SYSTEM

Intense heat sears meats and fish locking in juices, with large broiling area. All Gas Pro Ranges ventilation allows for closed door broiling, which ensures constant cooking.

OVEN

Dual Convection
 Oven temperature electronic control
 Nova Broiler System
 Black Porcelain enamel interior
 Cool to the touch, soft closing door
 Extra-large baking cavity and viewing area
 3 Halogen lights for flawless visibility
 Gross capacity 5.7 cu. ft.
 2 chromed racks
 1 telescopic rack
 Enameled Broiler Pan

OVEN FUNCTIONS

Bake
 Broil
 Convection
 Pizza cooking mode 590 °F
 Dehydrate
 Timer
 Sabbath Mode

SOFIA PROFESSIONAL 30"

30" ALL GAS PROFESSIONAL RANGE



CODE ID



F6PGR304S2

- Heavy Duty Grates
- Continuous Grate Surface
- Dual Crescendo Burner
- Dual Convection
- Soft Closing Door
- Cool Touch Door
- Multi-level cooking
- 1 Telescopic Rack
- Digital Controls
- Nova Broiler System



OPTIONAL ACCESSORIES pag

PDRKIT36 ...	Colour kit	81
FMWOK	Wok ring	83
FMSIM	Simmer plate	83
F6BG30BCI	Island trim	83
F6BG30STD	Standard trim	82
F6BG30HBT	High back trim	82
FMGRID30	Griddle	83
FMTRP30	Telescopic rack	84

TECHNICAL DWG	171
TECHNICAL DATA	190

SPECIFICATIONS

COOKING SURFACE

2 Heavy Duty, continuous cast iron grates
 One piece, matte finish porcelain burner bowl
 4 Dual-Flame Crescendo Burners
 1 X 20,000 BTU max (NG)
 3 X 18,000 BTU max (NG)
 Natural Gas (LP convertible)

NEW NOVA BROILER SYSTEM

Intense heat sears meats and fish locking in juices, with large broiling area. All Gas Pro Ranges ventilation allows for closed door broiling, which ensures constant cooking.

OVEN

Dual Convection
 Oven temperature electronic control
 Nova Broiler System
 Black Porcelain enamel interior
 Cool to touch, soft closing door
 Extra-large baking cavity and viewing area
 3 Halogen lights for flawless visibility
 Gross capacity 4.4 cu. ft.
 2 chromed racks
 1 telescopic rack
 Enameled Broiler Pan

OVEN FUNCTIONS

Bake
 Broil
 Convection
 Pizza cooking mode 590 °F
 Dehydrate
 Timer
 Sabbath Mode

NEW

FULGOR
MILANO

PROFESSIONAL 36" INDUCTION RANGE

The Sofia induction range features powerful premium induction technology under an elegant glass surface featuring a new 11" Dual Max Power burner.

The instant response and precise control of induction is highlighted by the Digital Minute Minder control, paired beautifully with the easy to clean surface, offering maximum performance while minimizing energy consumption.

NEW

PROFESSIONAL 36" INDUCTION RANGE

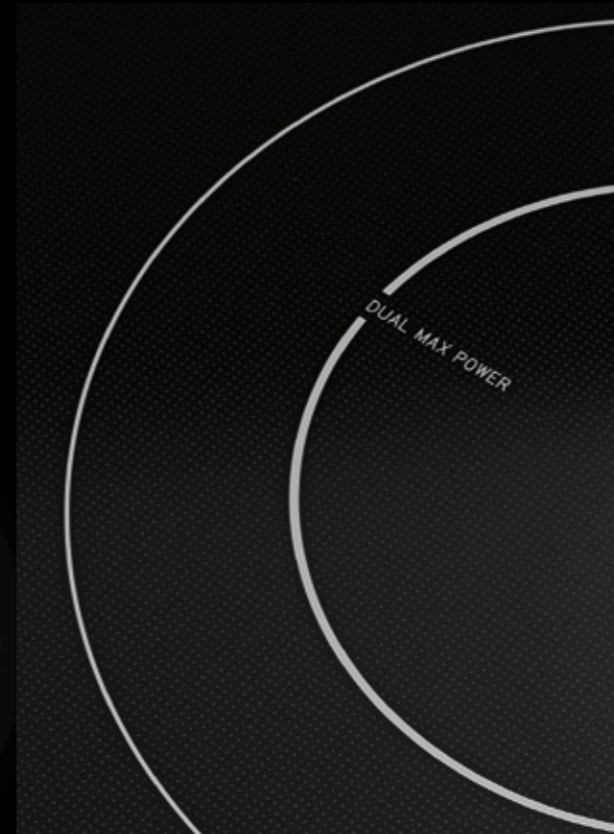

DUAL MAX POWER

Large pans receive full power for capacity and consistent heat distribution while cooking. The 11" Dual Induction Zone offers a fifth burner for any size pan at any power level for ultimate flexibility.

DIGITAL MINUTE MINDER CONTROL

Set it and forget it! The Digital Minute Minder chime will remind you of the end of the timer cycle.

COMMAND CONTROL KNOBS

Quick control, efficient and fast, a choice that combines style, practicality and professional touch.

SOFIA PROFESSIONAL 36"

36" INDUCTION PROFESSIONAL RANGE

NEW



CODE ID



F6PIR365S1



- Easy Clean Ceramic Glass
- Power Boost Burner
- Dual Max Power
- Pan Detection system
- Residual Heat Sensor
- Soft Closing Door
- Self Clean Oven
- Multi-level cooking
- 1 Telescopic Rack
- Cool Touch Door
- Digital Controls
- Meat Probe
- Fast Pre-Heat

OPTIONAL ACCESSORIES pag

PDRKIT36 ...	Colour kit	81
F6BG36BCI	Island trim	83
F6BG36STD	Standard trim	82
F6BG36HBT	High back trim	82
INDUKIT4	Induction plate adapters	85
FMTRP36	Telescopic rack	84

TECHNICAL DWG	171
TECHNICAL DATA	191

SPECIFICATIONS

COOKING SURFACE

4 Single Induction cooking zones
 1 Dual Max Power with Ø 11" cooking zone
 Elegant Ceramic glass surface
 Premium induction technology for unsurpassed performance
 Booster function for each cooking zone
 Residual heat and Power-on Indicators
 Melting and Simmering function
 Knob Controlled
 Digital Minute Minder
 Pot Detection System
 Child Lock Function

OVEN

Dual True Convection
 Self-cleaning oven with Multifunction baking
 Black Porcelain enamel interior
 Cool to the touch, soft closing door
 Extra-large baking cavity and viewing area
 3 Halogen lights for flawless visibility
 Gross capacity 5.7 cu. ft.
 2 chromed racks
 1 telescopic rack
 Enameled Broiler Pan

OVEN FUNCTIONS

Bake
 Broil
 Roast
 Convection
 True Convection
 Warm / Proof / Dehydrate
 Electronic cooking programmer
 Meat Probe
 Self-Clean
 Sabbath Mode

SOFIA PROFESSIONAL 30"

30" INDUCTION PROFESSIONAL RANGE



CODE ID



F6PIR304S1



- Easy Clean Ceramic Glass
- Power Boost Burner
- Pan Detection system
- Residual Heat Sensor
- Soft Closing Door
- Self Clean Oven
- Multi-level cooking
- 1 Telescopic Rack
- Cool Touch Door
- Digital Controls
- Meat Probe
- Fast Pre-Heat

OPTIONAL ACCESSORIES pag

PDRKIT30 ...	Colour kit	81
F6BG30BCI	Island trim	83
F6BG30STD	Standard trim	82
F6BG30HBT	High back trim	82
INDUKIT4	Induction plate adapters	85
FMTRP30	Telescopic rack	84

TECHNICAL DWG	171
TECHNICAL DATA	191

SPECIFICATIONS

COOKING SURFACE

4 Single Induction cooking zones
 Elegant Ceramic glass surface
 Premium induction technology for unsurpassed performance
 Booster function for each cooking zone
 Residual heat and Power-on Indicators
 Melting and Simmering function
 Pot Detection System
 Child Lock Function
 Failure Codes Indication
 Automatic Heat-up Time

OVEN

Dual True Convection
 Self-cleaning oven with Multifunction baking
 Black Porcelain enamel interior
 Cool to the touch, soft closing door
 Extra-large baking cavity and viewing area
 3 Halogen lights for flawless visibility
 Gross capacity 4.4 cu. ft.
 2 chromed racks
 1 telescopic rack
 Enameled Broiler Pan

OVEN FUNCTIONS

Bake
 Broil
 Roast
 Convection
 True Convection
 Warm / Proof / Dehydrate
 Electronic cooking programmer
 Meat Probe
 Self-Clean
 Sabbath Mode

SOFIA PROFESSIONAL 30"

30" PROFESSIONAL SINGLE OVEN - STAINLESS STEEL



CODE ID

F6PSP30S1



- Dual Convection
- Soft Closing Door
- Self Clean Oven
- Multi-level cooking
- 1 Telescopic Rack
- Cool Touch Door
- Digital Controls
- Meat Probe
- Fast Pre-Heat
- Interior Lighting

SPECIFICATIONS

OVEN

- Knob and electronic controls
- Dual True Convection
- Self-cleaning oven with Multifunction baking
- Black Porcelain enamel interior
- Cool to the touch, soft closing door
- Extra-large baking cavity and viewing area
- 3 Halogen lights for flawless visibility
- Gross capacity 4.4 cu. ft.
- 2 chromed racks
- 1 telescopic rack
- Enameled Broiler Pan

OVEN FUNCTIONS

- Bake
- Broil
- Roast
- Convection
- True Convection
- Warm / Proof / Dehydrate
- Electronic cooking programmer
- Meat Probe
- Self-Clean
- Sabbath Mode

OPTIONAL ACCESSORIES

pag

FMTRP30	Telescopic rack	84
TECHNICAL DWG		174
TECHNICAL DATA		192

SOFIA PROFESSIONAL 30"

30" PROFESSIONAL DOUBLE OVEN - STAINLESS STEEL



CODE ID

F6PDP30S1



- Dual Convection
- Soft Closing Door
- Self Clean Ovens
- Multi-level cooking
- 1 Telescopic Rack per oven
- Cool Touch Door
- Digital Controls
- Meat Probe (Upper Oven Only)
- Fast Pre-Heat
- Interior Lighting

SPECIFICATIONS

OVENS

- Knob and electronic controls
- Dual True Convection
- Self-cleaning oven with Multifunction baking
- Black Porcelain enamel interior
- Cool to the touch, soft closing door
- Extra-large baking cavity and viewing area
- 3 Halogen lights for flawless visibility
- Gross capacity 4.4 cu. ft. per oven
- 2 chromed racks
- 1 telescopic rack per oven
- Enameled Broiler Pan

OVEN FUNCTIONS

- Bake
- Broil
- Roast
- Convection
- True Convection
- Warm / Proof / Dehydrate
- Electronic cooking programmer
- Meat Probe (Upper Oven Only)
- Self-Clean
- Sabbath Mode

OPTIONAL ACCESSORIES

pag

FMTRP30	Telescopic rack	84
TECHNICAL DWG		174
TECHNICAL DATA		192

NEW

PROFESSIONAL 30" WARMING DRAWER



More than a warming drawer, this functional appliance can slow cook, proof, leaven, and defrost in its compact and fully enclosed space. Warm plates, hold side dishes warm for serving, keep pies warm for dessert, allow homemade bread to rise to perfection.

SOFIA PROFESSIONAL 30"





30" PROFESSIONAL WARMING DRAWER - STAINLESS STEEL

NEW

CODE ID

F6PWD30S1



-  Sliding Telescopic Rails
-  Keep Warm Function
-  Leavening
-  Slow Cooking
-  Thawing
-  Soft Closing

SPECIFICATIONS

WARMING DRAWER 30"

- Knob Control
- Heavy Duty full extendable telescopic rails
- Large capacity 2,1 cu. ft.
- Convection heating system for even heat distribution
- All stainless steel structure
- Warming Temperature range; min. 86 °F up to 190 °F
- Slow closing assistance
- 2 Internal lights
- Non-slip rubber mat

DRAWER 30" FUNCTIONS

- Pre-heat dishes
- Pre-heat coffee cups
- Keep warm ready food
- Defrosting
- Leavening dough
- Slow cooking min. 86 °F up to 190 °F

OPTIONAL ACCESSORIES

TECHNICAL DWG	174
TECHNICAL DATA	193



SOFIA PROFESSIONAL 36"





36" PROFESSIONAL GAS RANGE TOP

CODE ID

F6GRT366S1



-  Heavy Duty Grates
-  Continuous Grate Surface
-  Dual Crescendo Burner

SPECIFICATIONS

GAS RANGE TOP

- 3 Heavy Duty, continuous cast iron grates
- One piece, matte finish porcelain burner bowl
- 6 Dual-Flame Crescendo Burners
- 2 X 20,000 BTU max (NG)
- 4 X 18,000 BTU max (NG)
- Natural Gas (LP convertible)
- Electric Re-ignition system
- Flame-out Sensing
- Top Mount Injectors

OPTIONAL ACCESSORIES

pag

FMWOK	Wok ring	83
FMSIM	Simmer plate	83
F6BG36BCI	Island trim	83
F6BG36STD	Standard trim	82
F6BG36HBT	High back trim	82
FMGRID36	Griddle	83

TECHNICAL DWG 172

TECHNICAL DATA 194

SOFIA PROFESSIONAL 30"

30" PROFESSIONAL GAS RANGE TOP



CODE ID

F6GRT304S1



- Heavy Duty Grates
- Continuous Grate Surface
- Dual Crescendo Burner



SPECIFICATIONS

GAS RANGE TOP

- 2 Heavy Duty, continuous cast iron grates
- One piece, matte finish porcelain burner bowl
- 4 Dual-Flame Crescendo Burners
- 1 X 20,000 BTU max (NG)
- 3 X 18,000 BTU max (NG)
- Natural Gas (LP convertible)
- Electric Re-ignition system
- Flame-out Sensing
- Top Mount Injectors

OPTIONAL ACCESSORIES

		pag
FMWOK	Wok ring	83
FMSIM	Simmer plate	83
F6BG30BCI	Island trim	83
F6BG30STD	Standard trim	82
F6BG30HBT	High back trim	82
FMGRID30	Griddle	83

TECHNICAL DWG 172

TECHNICAL DATA 194

SOFIA PROFESSIONAL 30"

30" PROFESSIONAL INDUCTION RANGE TOP



CODE ID

F6IRT304S1



- Easy Clean Ceramic Glass
- Power Boost Burner
- Pan Detection system
- Digital Controls
- Residual Heat Sensor
- Warming Function

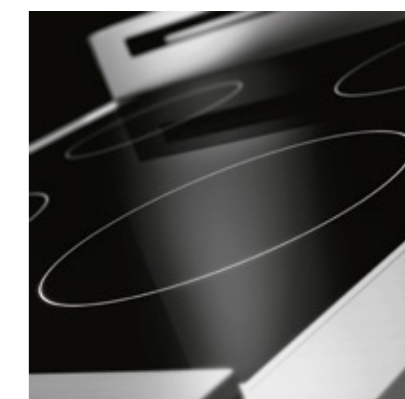

SPECIFICATIONS

INDUCTION RANGE TOP

- 4 Single Induction cooking zones
- Elegant Ceramic glass surface
- Premium induction technology for unsurpassed performance
- Booster function for each cooking zone
- Residual heat and Power on Indicators
- Melting and Simmering functions
- Pot Detection System
- Child Lock Function
- Failure Codes Indication
- Digital Display for Power Level
- Automatic Heat-up Time

OPTIONAL ACCESSORIES

		pag
F6BG30BCI	Island trim	83
F6BG30STD	Standard trim	82
F6BG30HBT	High back trim	82
INDUKIT4	Induction plate adapters	85

TECHNICAL DWG 172

TECHNICAL DATA 195

NEW

FULGOR
MILANO

PROFESSIONAL PRO GAS COOK TOP



STRONG, POWERFUL, DISTINCTIVE

With sleek lines, a continuous surface grate over powerful brass burners, and LED illuminated controls, the Sofia cooktop combines elegant design, responsive performance, and thoughtful convenience. Sofia enters a new realm with this low profile cooktop allowing design flexibility for your kitchen. Enjoy the power of a 20,000 BTU Dual Brass Burner of this Sofia cooktop while using the additional 4 Dual Stack Burners, designed to surpass all of your expectations. New Halo Effect knobs let you know at a glance if the gas is on or if residual heat is present, giving you peace of mind at every turn. Continuous cast iron grates offer an even cooking surface for easy movement of pans from burner to burner so that even your biggest cooking events can be handled with ease.

NEW

HALO VISION

HEAT MADE VISIBLE



HALO CONTROL

for when the gas is on

Have you ever walked away from your cook top forgetting a burner is on?

Whether you are searing a steak or tempering chocolate, the glowing halo of white light will alert you to a burner that is on.

Walk away from the kitchen with confidence, knowing that your burners are safely off when the halo disappears.

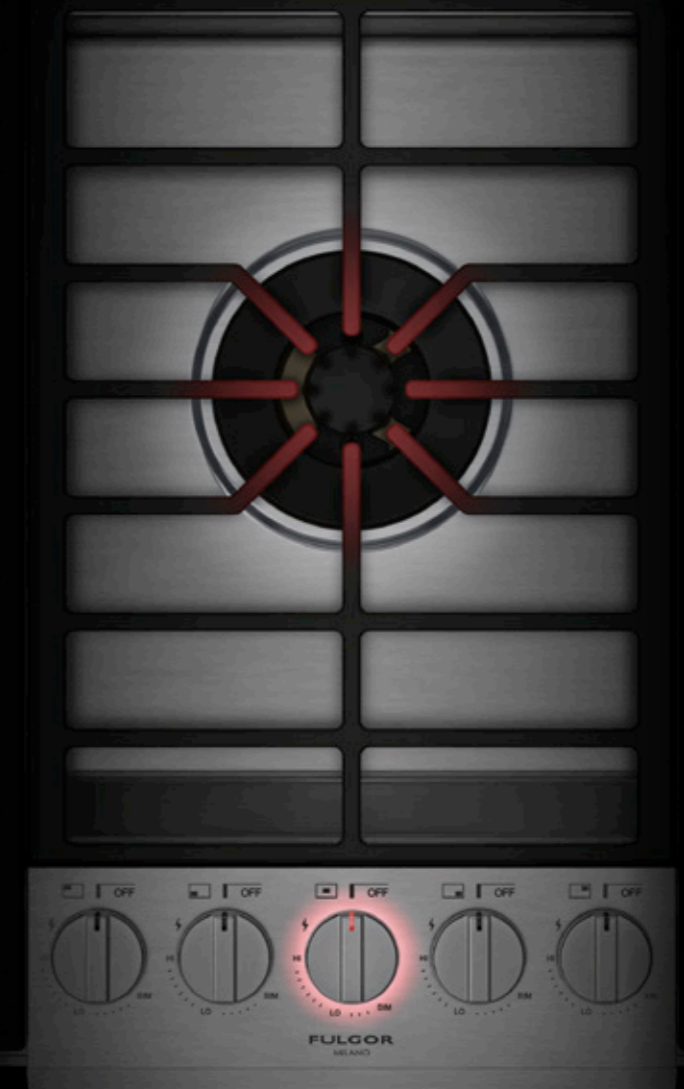

HALO SAFE

residual heat indicator

A Professional cook top would not be complete without powerful burners and strong cast iron grates. These grates can continue to radiate a heat, even after the burner is off. Protect yourself and your family with our Halo Safe system. A red Halo light around the control knob indicates the presence of residual heat at the grate.

NEW

SOFIA PROFESSIONAL 36"







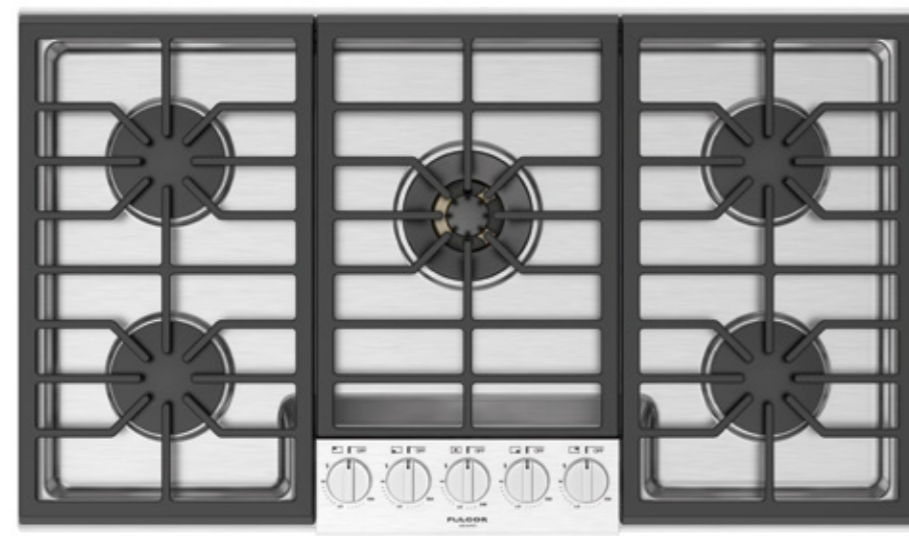

CODE ID

F6PGK365S1

36" PROFESSIONAL PRO GAS COOK TOP



-  Knob control with back light system
-  1 Center Dual Burner
-  4 Stack Burner
-  Heavy Duty Grates
-  Continuous Grate Surface
-  Heavy Duty Control Panel



SPECIFICATIONS

COOKING SURFACE

3 Heavy duty continuous cast iron grates
 Heavy Gauge 304 Stainless Steel Burner Bowl
 1 Solid Brass Dual Flame Burner with 20.000 BTU Max (NG)
 4 Solid Brass Stacked Burners with 18.000 BTU Max (NG)
 Backlit Control Knob indicates burner operation (White)
 Backlit Control Knob indicates residual heat (Red)
 Heavy duty control panel
 Large cooking area
 Full pot stability
 Natural Gas (LP Convertible)

OPTIONAL ACCESSORIES

pag

FMWOK	Wok ring	83
FMSIM	Simmer plate	83

TECHNICAL DWG 173

TECHNICAL DATA 196

NEW

SOFIA PROFESSIONAL 30"







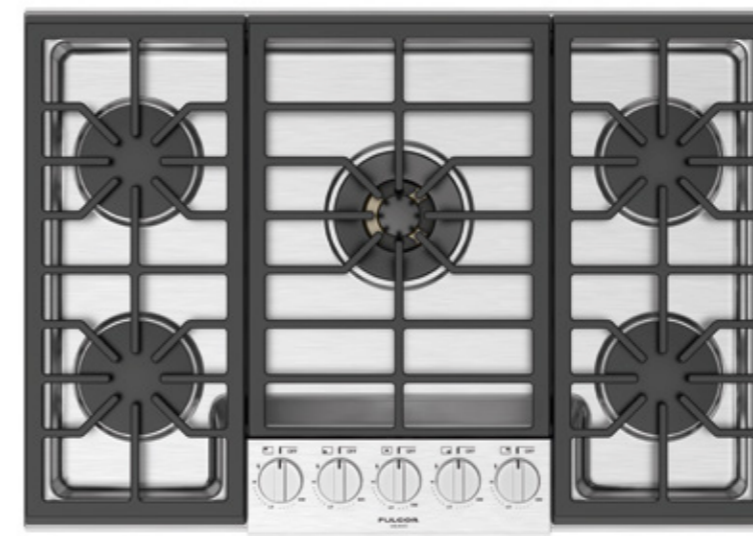

CODE ID

F6PGK305S1

30" PROFESSIONAL PRO GAS COOK TOP



-  Knob control with back light system
-  1 Center Dual Burner
-  4 Stack Burner
-  Heavy Duty Grates
-  Continuous Grate Surface
-  Heavy Duty Control Panel



SPECIFICATIONS

COOKING SURFACE

3 Heavy duty continuous cast iron grates
 Heavy Gauge 304 Stainless Steel Burner Bowl
 1 Solid Brass Dual Flame Burner with 20.000 BTU Max (NG)
 2 Solid Brass Stacked Burners with 18.000 BTU Max (NG)
 2 Solid Brass Stacked Burners with 15.000 BTU Max (NG)
 Backlit Control Knob indicates burner operation (White)
 Backlit Control Knob indicates residual heat (Red)
 Heavy duty control panel
 Large cooking area
 Full pot stability
 Natural Gas (LP Convertible)

OPTIONAL ACCESSORIES

pag

FMWOK	Wok ring	83
FMSIM	Simmer plate	83

TECHNICAL DWG 173

TECHNICAL DATA 197

NEW

FULGOR
MILANO

PROFESSIONAL HOODS 600 SERIES

Complete your powerful Sofia cooking suite with a matching wall mounted vent hood designed to keep your kitchen environment free from smoke, cooking residue, and excess heat. Motors in sturdy housings combine with Pro Baffle filters to quietly whisk away the effects of your culinary adventures. Your hood allows fresh air to circulate freely in your home, while overhead LED illumination highlights your Sofia cooking surface. Like jewelry for your home, hoods offer the very best of function and design. Your well ventilated kitchen will thank you for it!



HOODS

HOODS

LED LIGHTING UNIFORM CONTROLS

To get the best possible view of your culinary creations while you work, illuminate the entire cooking surface with 6 high powered LED lights. When you are finished cooking, Sofia can bask in the lower level lighting, casting your kitchen as the star of your home.

ADJUSTABLE DUAL MOTORS WITH DIRECT INDIVIDUAL MOTOR CONTROL

At the heart of the hood, dual motors are housed separately in sturdy bodies, keeping noise and vibration to a minimum. Quiet enough to be unnoticed even at its maximum 1000 cfm speed, the hood works hard to whisk away heat, smoke, odor and moisture, keeping your kitchen fresh and clean while you entertain your family and friends.





SOFIA PROFESSIONAL SERIES 600 48"

48" PROFESSIONAL HOOD

NEW



CODE ID

F6PH48DS1



Filtering



CFM max 1000



6 LED lamps



Noise Level 75 (dB)



Wall hung installation

SPECIFICATIONS

HOOD

Scotch brite stainless steel (AISI 430)
 Heavy Duty Control Panel with Knobs
 4 + 4 Speed Mechanical Control
 LED lighting
 Led 6x1,2 W - 3200 K
 Double fan motors
 1000 CFM
 75 dB sound rating
 Baffle filter
 Minimum distance
 Electric hob 20 1/2" - 52 cm
 Gas hob 24 3/4" - 63 cm

OPTIONAL ACCESSORIES

pag

F6CK48-12	Chimney cover	86
FMFIL	Charcoal filter	86

TECHNICAL DWG 175

TECHNICAL DATA 198

SOFIA PROFESSIONAL 600 SERIES 36"





36" PROFESSIONAL HOOD



NEW





CODE ID

F6PH36DS1 2 FAN - KNOBS

-  Filtering
-  CFM max 1000
-  4 LED lamps
-  Noise Level 75 (dB)
-  Wall hung installation

CODE ID

F6PH36S1 1 FAN - SLIDER

-  Filtering
-  CFM max 600
-  4 LED lamps
-  Noise Level 72 (dB)
-  Wall hung installation



SPECIFICATIONS

HOOD F6PH36DS1

Scotch brite stainless steel (AISI 430)
Heavy Duty Control Panel with Knobs
4 + 4 Speed - Mechanical Control
LED lighting: Led 4x1.2 W - 3200 K
Dual fan motors
CFM max 1000
75 dB sound rating
Baffle filter
Minimum distance:
Electric hob 20 1/2" - 52 cm
Gas hob 24 3/4" - 63 cm

HOOD F6PH36S1

Scotch brite stainless steel (AISI 430)
Slider controls
LED lighting: Led 4x1.2 W - 3200 K
One fan motor
CFM max 600
72 dB sound rating
Baffle filter
Minimum distance:
Electric hob 20 1/2" - 52 cm
Gas hob 24 3/4" - 63 cm

OPTIONAL ACCESSORIES

pag

F6CK36-12	Chimney cover	86
FMFIL	Charcoal filter	86

TECHNICAL DWG 175

TECHNICAL DATA 198

SOFIA PROFESSIONAL 600 SERIES 30"





30" PROFESSIONAL HOOD



NEW





CODE ID

F6PH30S2 1 FAN - KNOBS

-  Filtering
-  CFM max 600
-  4 LED lamps
-  Noise Level 72 (dB)
-  Wall hung installation

CODE ID

F6PH30S1 1 FAN - SLIDER

-  Filtering
-  CFM max 600
-  2 LED lamps
-  Noise Level 72 (dB)
-  Wall hung installation



SPECIFICATIONS

HOOD F6PH30S2

Scotch brite stainless steel (AISI 430)
Heavy Duty Control Panel with Knobs
4 Speed - Mechanical Control
LED lighting: Led 4x1.2 W - 3200 K
One fan motor
CFM max 600
72 dB sound rating
Baffle filter
Minimum distance:
Electric hob 20 1/2" - 52 cm
Gas hob 24 3/4" - 63 cm

HOOD F6PH30S1

Scotch brite stainless steel (AISI 430)
Slider controls
LED lighting: Led 2x1.2 W - 3200 K
One fan motor
CFM max 600
72 dB sound rating
Baffle filter
Minimum distance:
Electric hob 20 1/2" - 52 cm
Gas hob 24 3/4" - 63 cm

OPTIONAL ACCESSORIES

pag

F6CK30-12	Chimney cover	86
FMFIL	Charcoal filter	86

TECHNICAL DWG 175

TECHNICAL DATA 198

NEW

SOFIA PROFESSIONAL 600 SERIES 48"



CODE ID

F6BP46DS1

48" PROFESSIONAL INSERT HOOD



Filtering



CFM max 1000



6 LED lamps



Noise Level 75 (dB)



Ceiling installation

NEW

SOFIA PROFESSIONAL 600 SERIES 36"



CODE ID

F6BP34DS1

36" PROFESSIONAL INSERT HOOD



Filtering



CFM max 1000



4 LED lamps



Noise Level 75 (dB)



Ceiling installation

SPECIFICATIONS

INSERT HOOD

Scotch brite stainless steel (AISI 430)
 Heavy Duty Control Panel with Knobs
 LED lighting: Led 6x1,2 W - 3200 K
 4 + 4 Speed - Mechanical Control
 Baffle filter
 Dual fan motors - CFM max 1000
 75 dB sound rating
 Minimum distance:
 Electric hob 20 1/2" - 52 cm
 Gas hob 24 3/4" - 63 cm

Overall dim - width 45 3/4" - 116 cm
 Overall dim - height 13 1/8" - 33 cm
 Overall dim - depth 18 1/2" - 47 cm
 Cut out (wxd) 43 7/16" x 16 1/2"
 Gross weight 68 lbs - 31 kg
 Net weight 57 lbs - 26 kg
 KW rating 860W - 3.8A
 Power cord + Plug

OPTIONAL ACCESSORIES

pag

FMFIL Charcoal filter 86

TECHNICAL DWG 175

TECHNICAL DATA 199

SPECIFICATIONS

INSERT HOOD

Scotch brite stainless steel (AISI 430)
 Heavy Duty Control Panel with Knobs
 LED lighting: Led 4x1,2 W - 3200 K
 4 + 4 Speed - Mechanical Control
 Baffle filter
 Dual fan motors - CFM max 1000
 75 dB sound rating
 Minimum distance:
 Electric hob 20 1/2" - 52 cm
 Gas hob 24 3/4" - 63 cm

Overall dim - width 34 1/4" - 87 cm
 Overall dim - height 13 1/8" - 33 cm
 Overall dim - depth 18 1/2" - 47 cm
 Cut out (wxd) 32" 1/16 x 16 1/2"
 Gross weight 60 lbs - 27 kg
 Net weight 51 lbs - 23 kg
 KW rating 860W - 3.8A
 Power cord + Plug

OPTIONAL ACCESSORIES

pag

FMFIL Charcoal filter 86

TECHNICAL DWG 175

TECHNICAL DATA 199

NEW

FULGOR
MILANO

PROFESSIONAL FRIDGE & WINE

COLD TEMP. TOTAL CONTROL.

As beautiful as it is functional, the Sofia Professional Fridge and Wine Series features brushed stainless exteriors for maximum impact and a brilliant white aluminum interior. Food preservation is key and like the rest of the Professional Series, we combine the latest technology to ensure the highest performance.

Dual compressors provide independently controlled cooling zones with consistent and precise temperatures throughout, to ensure that the finest foods and wines stay fresher longer.

Robust doors on the Fridge and triple layer UV protected glass on the Wine Cellar protect contents from external temperature and humidity changes which can be damaging to your stored items.

FRIDGE

FRIDGE

NEW

PROFESSIONAL FRIDGE & WINE



FLEXZONE

Fridge, Fresco, or Freezer: you can decide on a whim! Need more space for cold drinks? Turn the bottom Flexzone drawer into a Fresco compartment through a simple menu. You have the flexibility to manage your food preservation how you desire.

ICE MAKER

Located in the upper section of the Flexzone drawer, the ice maker uses purified water from the integrated filtering system to produce up to 2.2 lbs of your desired sized cube. Activate SuperIce and increase ice production to 3.3 lbs.

WINE CELLAR

Natural beechwood shelves accommodate various sized bottles for secure storage and can even be completely removed for greater flexibility. In addition to humidity and temperature control, Wine Cellars utilize anti-vibration technology and triple pane bronze glass doors to reduce UV rays, protecting your wine collection from external conditions.

SOFIA PROFESSIONAL WINE CELLAR 24"

24" PROFESSIONAL WINE CELLAR











NEW

CODE ID

F7PBW24S1-R (RIGHT DOOR)

CODE ID

F7PBW24S1-L (LEFT DOOR)

-  Deep-freezing
-  Hot air ventilation
-  Rapid Deep Freezing
-  LED lighting
-  Noise Level 41 (dB)
-  Integrated Installation
-  Holiday Mode
-  Triple Panel Door
-  54 Bottles Capacity

SPECIFICATIONS

WINE CELLAR

Cave Storage Compartment,
Natural Wood Shelves, for 36 bottles
Wine Cellar Compartment,
Natural Wood Shelves, for 18 bottles
TriplePlay Refrigeration
Total No Frost
LED Lighting
Brilliant white aluminium interior
TriZone Bottom Drawer

OPTIONAL ACCESSORIES

pag

TECHNICAL DWG

176

TECHNICAL DATA

201

SOFIA PROFESSIONAL FRIDGE 36"

36" PROFESSIONAL FRIDGE



NEW

CODE ID

F7PBM36S1-R (RIGHT DOOR)

CODE ID

F7PBM36S1-L (LEFT DOOR)

-  Cool Zone 0°C
-  Deep-freezing
-  Hot air ventilation
-  Total No Frost
-  Rapid Deep Freezing
-  LED lighting
-  Noise Level 41 (dB)
-  Integrated Installation
-  Holiday Mode
-  Ice Maker

SPECIFICATIONS

FRIDGE

Fridge Compartment
Flexzone Bottom Drawer
Total No Frost
Stainless Steel Crisper Drawers
Ice Maker with ice tray
LED Lighting
Brilliant white aluminium interior

OPTIONAL ACCESSORIES

pag

TECHNICAL DWG

176

TECHNICAL DATA

200

BUILT-IN WINE CELLAR 24"

24" PROFESSIONAL BUILT-IN WINE CELLAR



SPECIFICATIONS

WINE CELLAR

Cave Storage Compartment,
Natural Wood Shelves, for 36 bottles
Wine Celler Compartment,
Natural Wood Shelves, for 18 bottles
TriplePlay Refrigeration
Total No Frost
LED Lighting
Brilliant white aluminium interior
TriZone Bottom Drawer











NEW

CODE ID

F71BW2401-R (RIGHT DOOR)

CODE ID

F71BW2401-L (LEFT DOOR)

-  Deep-freezing
-  Hot air ventilation
-  Rapid Deep Freezing
-  LED lighting
-  Noise Level 41 (dB)
-  Integrated Installation
-  Holiday Mode
-  Triple Panel Door
-  54 Bottles Capacity
-  Overlay Panel



OPTIONAL ACCESSORIES

pag

REFHANPRO24 Sofia Wine Celler Pro Handle Kit 87

TECHNICAL DWG 177

TECHNICAL DATA 201

BUILT-IN FRIDGE 36"

36" PROFESSIONAL BUILT-IN FRIDGE

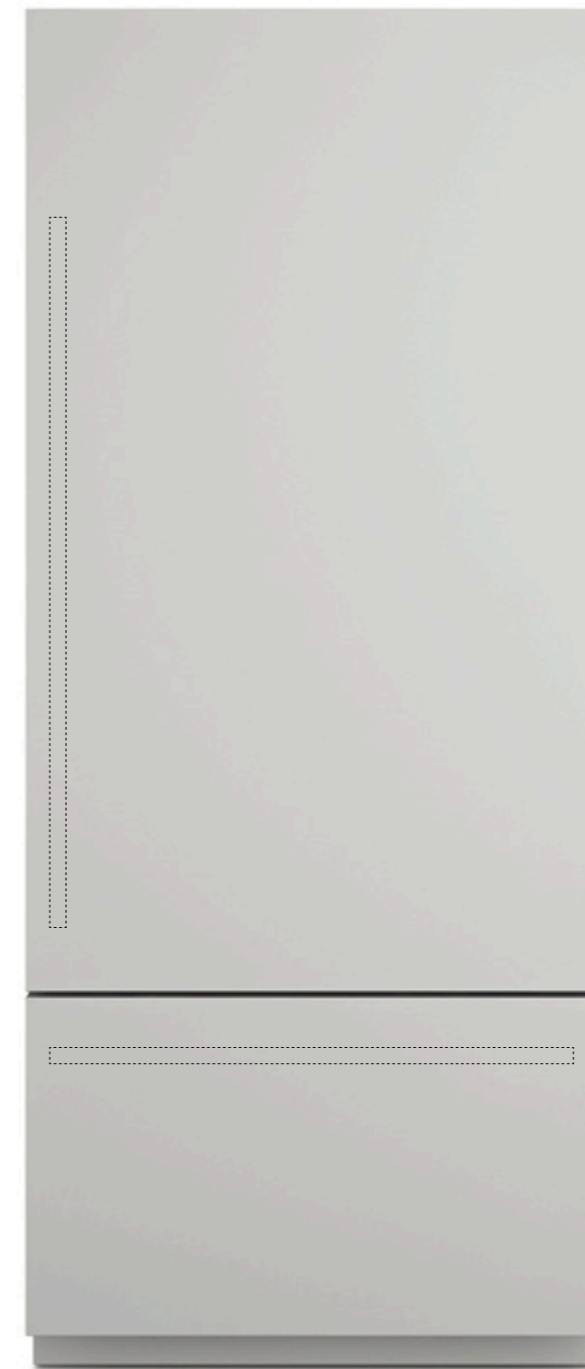

SPECIFICATIONS

FRIDGE

Fridge Compartment
Flexzone Bottom Drawer
Total No Frost
Stainless Steel Crisper Drawers
Ice Maker with ice tray
LED Lighting
Brilliant white aluminium interior

NEW

CODE ID

F71BM3601-R (RIGHT DOOR)

CODE ID

F71BM3601-L (LEFT DOOR)

-  Cool Zone 0°C
-  Deep-freezing
-  Hot air ventilation
-  Total No Frost
-  Rapid Deep Freezing
-  LED lighting
-  Noise Level 41 (dB)
-  Integrated Installation
-  Holiday Mode
-  Ice Maker
-  Overlay Panel



OPTIONAL ACCESSORIES

pag

REFHANPRO36 Sofia Fridge Pro Handle Kit 87

TECHNICAL DWG 177

TECHNICAL DATA 200

CLEAN



SOFIA PROFESSIONAL DISHWASHER 24"

24" INTEGRATED DISHWASHER WITH STAINLESS STEEL PROFESSIONAL EXTERIOR



CODE ID

F6PDW24SS1



- Noise Level 49 (dB)
- Steel Tub
- Fast Wash Cycle
- China and Crystal Cycle
- 1/2 Load Cycle
- Delayed Start

CLEAN



SPECIFICATIONS

DISHWASHER

- Quiet plus – 49 dB
- Stainless steel interior tub
- 10 wash cycles
- Fast wash cycles
- Adjustable height upper rack
- 13 place settings
- Concealed heating element
- Extreme wash (sanitization)
- Professional Handle

OPTIONAL ACCESSORIES

- | | |
|-----------------------|-----|
| TECHNICAL DWG | 174 |
| TECHNICAL DATA | 202 |

FULGOR
MILANO

PROFESSIONAL
ACCESSORIES
OPTIONAL



ACCESSORIES

ACCESSORIES

COLOR KIT

NEW

FULGOR
MILANO



PERSONALIZE WITH COLOR

Your cooking style is personal and now you can easily personalize your kitchen with color. Dress Sofia in vibrant Venetian Red, snowy Palladio White, glistening Gondola Black, sumptuous Black Velvet, or or glistening Rialto Grey. With a Sofia Color Kit, making a change is breeze, simply replace the door and one piece toe-kick whenever the mood strikes you. Sofia can even change with the seasons to make your kitchen alive with color.

FREEDOM TO CHOOSE COLOR



PALLADIO WHITE

GLOSSY WHITE - RAL 9016

BLACK VELVET

MATTE BLACK - RAL 9004

RIALTO GREY

MATTE GREY - RAL 9007 "SLATE"

GONDOLA BLACK

GLOSSY BLACK - RAL 9004

VENETIAN RED

GLOSSY RED - RAL 3003

48" PROFESSIONAL RANGE DOOR - COLOUR KIT

OPTIONAL ACCESSORIES



VERSION STANDARD STAINLESS STEEL



BLACK VELVET MATTE BLACK - RAL 9004

48" PRO RANGE DOOR CODE **PDRKIT48MB**



GONDOLA BLACK GLOSSY BLACK - RAL 9004

48" PRO RANGE DOOR CODE **PDRKIT48BK**



VENETIAN RED GLOSSY RED - RAL 3003

48" PRO RANGE DOOR CODE **PDRKIT48RD**



PALLADIO WHITE GLOSSY WHITE - RAL 9016

48" PRO RANGE DOOR CODE **PDRKIT48WH**



RIALTO GREY MATTE GREY - RAL 9007 "SLATE"

48" PRO RANGE DOOR CODE **PDRKIT48MG**

36" - 30" PROFESSIONAL RANGE DOOR - COLOUR KIT

OPTIONAL ACCESSORIES



VERSION STANDARD STAINLESS STEEL



BLACK VELVET MATTE BLACK - RAL 9004

36" PRO RANGE DOOR CODE **PDRKIT36MB**
30" PRO RANGE DOOR CODE **PDRKIT30MB**



GONDOLA BLACK GLOSSY BLACK - RAL 9004

36" PRO RANGE DOOR CODE **PDRKIT36BK**
30" PRO RANGE DOOR CODE **PDRKIT30BK**



VENETIAN RED GLOSSY RED - RAL 3003

36" PRO RANGE DOOR CODE **PDRKIT36RD**
30" PRO RANGE DOOR CODE **PDRKIT30RD**



PALLADIO WHITE GLOSSY WHITE - RAL 9016

36" PRO RANGE DOOR CODE **PDRKIT36WH**
30" PRO RANGE DOOR CODE **PDRKIT30WH**



RIALTO GREY MATTE GREY - RAL 9007 "SLATE"

36" PRO RANGE DOOR CODE **PDRKIT36MG**
30" PRO RANGE DOOR CODE **PDRKIT30MG**

PROFESSIONAL STAINLESS BACK GUARD TRIM

OPTIONAL ACCESSORIES

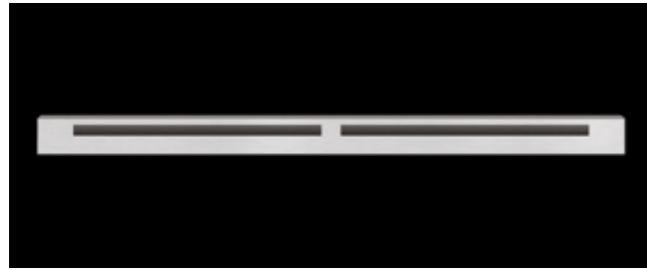

48" Back Guard - 3" Standard Trim

CODE **F6BG48STD**



48" Back Guard - High Back Trim

CODE **F6BG48HBT**



36" Back Guard - 3" Standard Trim

CODE **F6BG36STD**



36" Back Guard - High Back Trim

CODE **F6BG36HBT**



30" Back Guard - 3" Standard Trim

CODE **F6BG30STD**



30" Back Guard - High Back Trim

CODE **F6BG30HBT**

PROFESSIONAL GAS

OPTIONAL ACCESSORIES

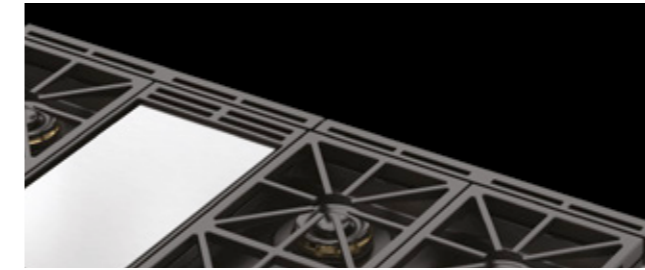

48" Black Cast Iron - Island Trim

CODE **F6BG48BCI**



Griddle Cover

CODE **FMGRIDCOV48**

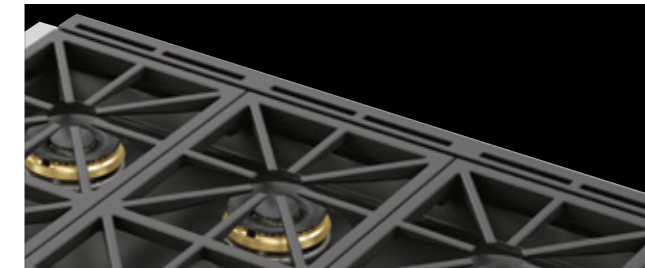

36" Black Cast Iron - Island Trim

CODE **F6BG36BCI**

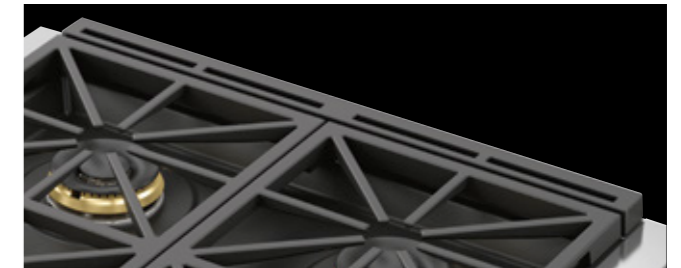

30" Black Cast Iron - Island Trim

CODE **F6BG30BCI**



36" Heavy duty enamelled Cast-Iron griddle

CODE **FMGRID36**



30" Heavy duty enamelled Cast-Iron griddle

CODE **FMGRID30**



WOK RING

CODE **FMWOK**

For best results with a wok, use this accessory with high-BTU burner specifically creactived for wok cooking.



SIMMER PLATE

CODE **FMSIM**

The cast-iron simmer plate provides a steady simmer temperature, evenly distributed across a stable heating surface

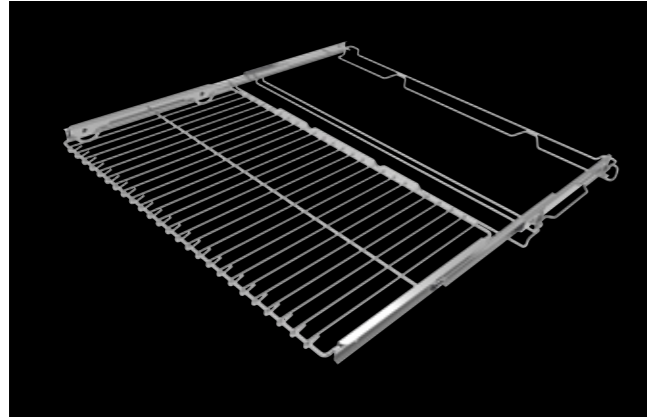

36" Telescopic rack
Telescopic rack for 36" Professional range

CODE **FMTRP36**

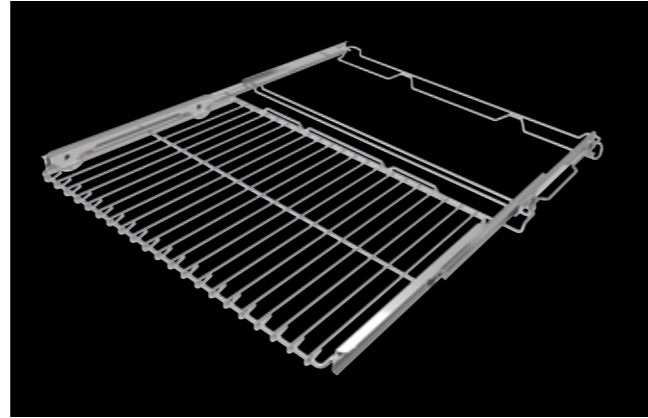

30" Telescopic rack
Telescopic rack for 30" Professional range and built-in oven

CODE **FMTRP30**



18" Telescopic rack
Telescopic rack for 18" Oven on 48" Professional range

CODE **FMTRP18**

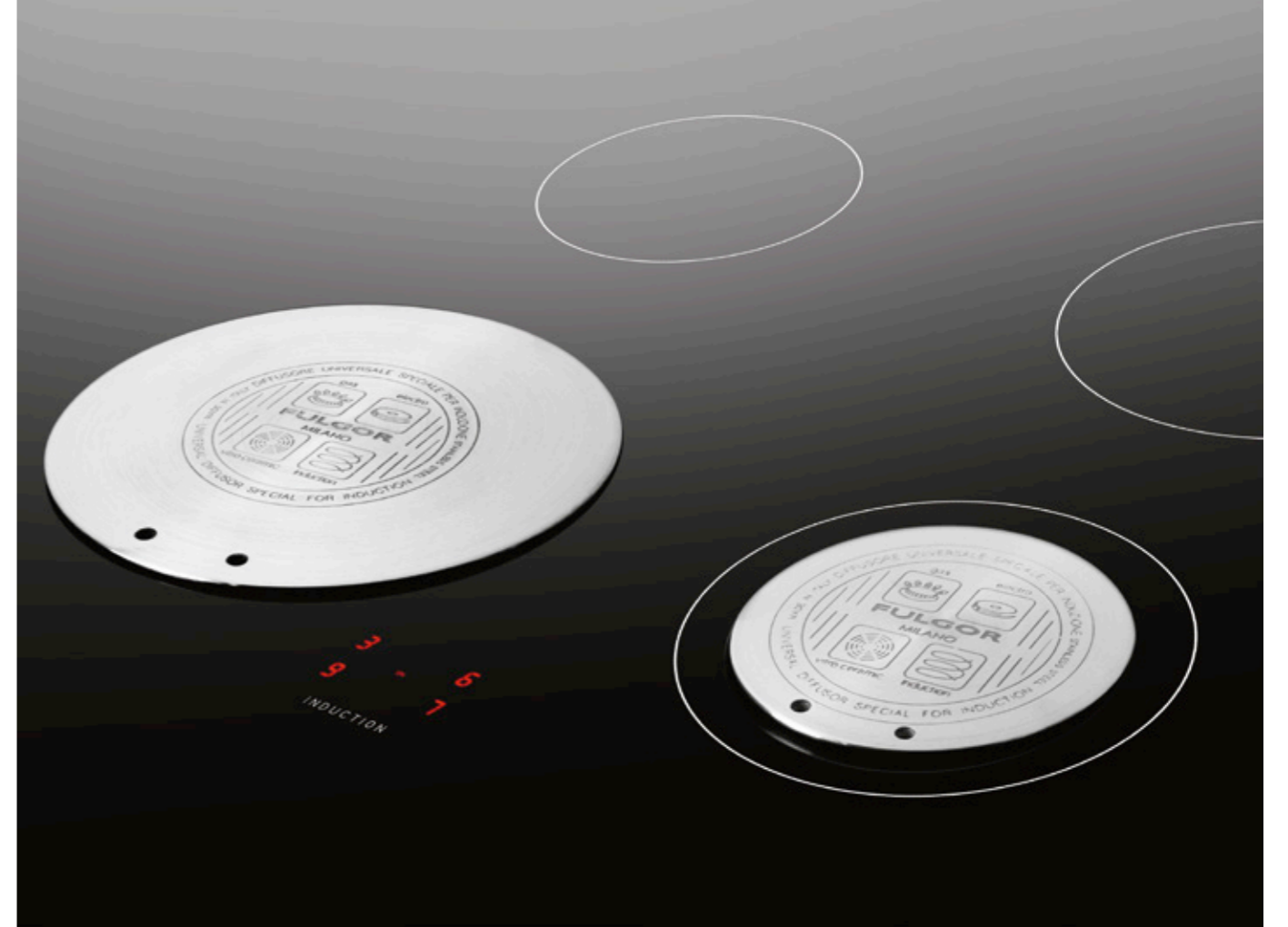

Trilaminar magnetic plates for non induction pots

CODE **INDUKIT4**

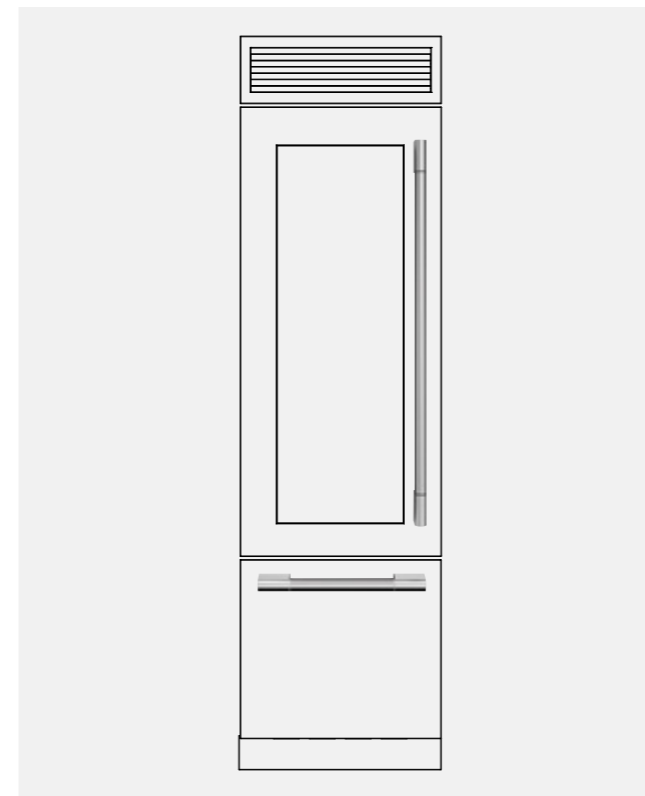
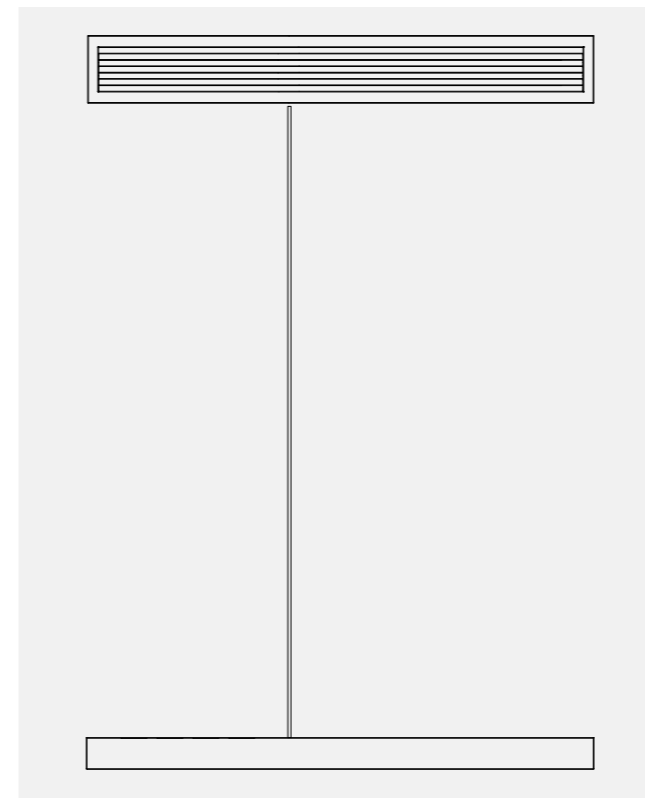
Chimney cover for model F6PH48S1 12" high CODE **F6CK48-12**Chimney cover for model F6PH36S1 12" high CODE **F6CK36-12**Chimney cover for model F6PH30S1 12" high CODE **F6CK30-12**Charcoal filters (for recirculating installations) CODE **FMFIL**Sofia Wine Celler Pro Handle Kit CODE **REFHANPRO24**Sofia Fridge Pro Handle Kit CODE **REFHANPRO36**

36" Pro Fridge and 24" Pro Wine Celler Installation Kit; Top Grate, Toe Kick, Vertical Gasket Strip and Insulation Panel.

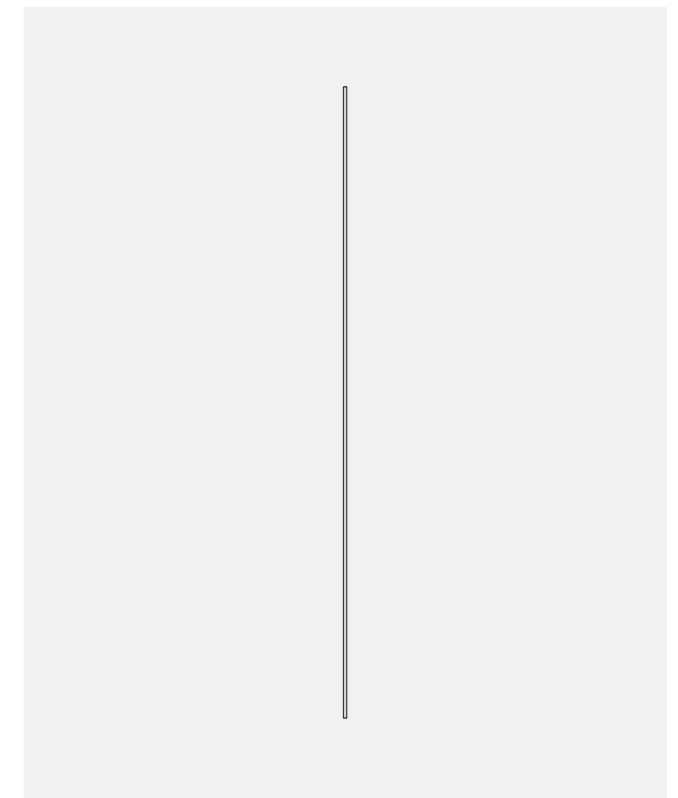
CODE **REFSBSPRO60**

36" Built-In Fridge and 24" Built-In Wine Celler Installation Kit.

CODE **REFSBSINT60**

DISTINTO

LINE





CREARE, IMMAGINARE, VIVERE

FULGOR
MILANO

DISTINTO

LINE

This powerful line of products that has, in essence, modularity and the linear stroke of its distinctive features. Like a chef who moves with ease and grace in the kitchen, intuitive displays allow simple recall of recipes and specialties.

The functionality of these new ovens equally matches our modern lifestyle, effortlessly allowing us to make the most of our culinary creations. This new standard is the symbol of modernity, created in Italy.

CREACTIVE
A CHEF
IN YOUR
HOME

FULGOR
MILANO

MULTIFUNCTION OVENS



Our Creative control system combines modern technology with simplicity. The touch screen simplifies all procedures and enhances performance by reducing energy consumption while intensifying cooking modes.

The automatic function control system has safety features providing worry-free operation.

DISTINTO OVENS CREACTIVE

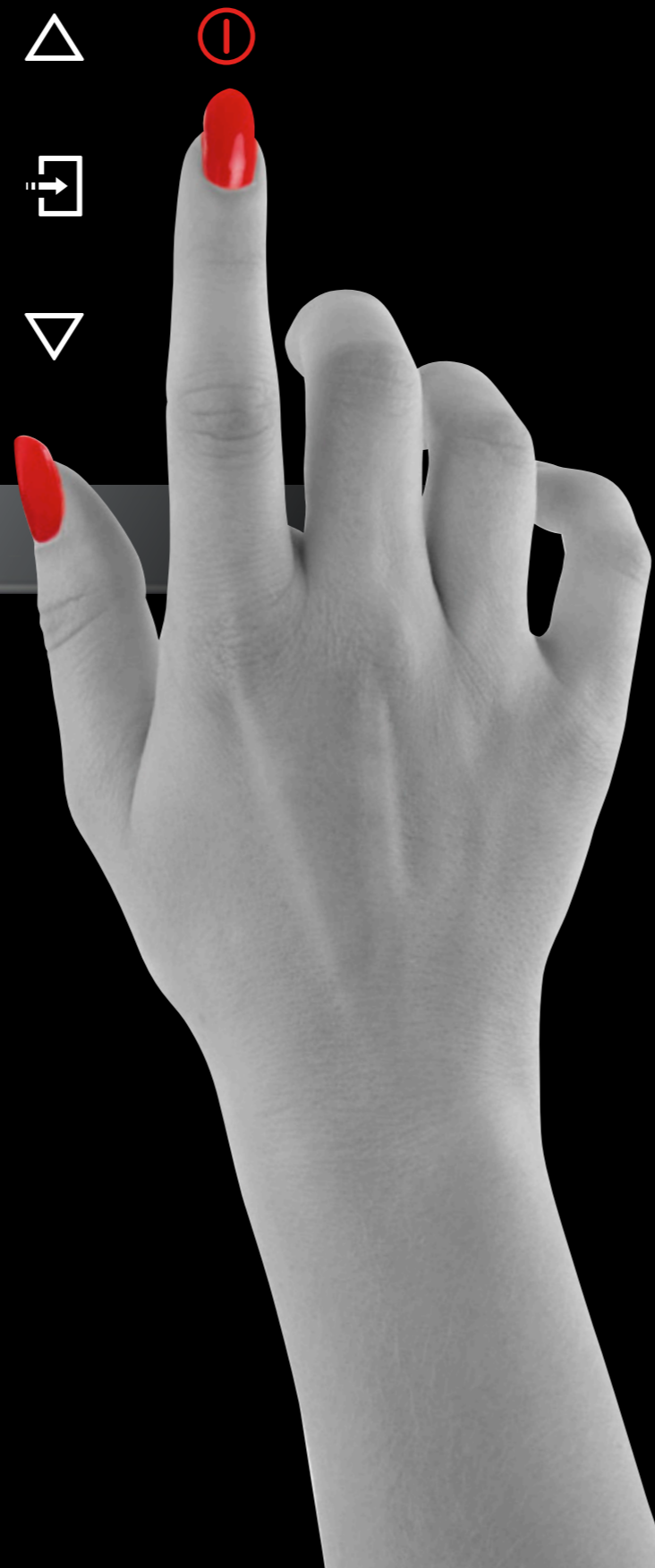

TOUCH CONTROL PANEL

Everything is under your control with just a touch on the Creactive display.

INTUITIVE

It only takes a moment to easily find the desired function.

MULTITASKING

All functions help to get the best results while preparing your recipes.

CUSTOMIZABLE RECIPES

Recipes to suit every palate have been pre-programmed, but you can modify and customize them to your specific requirements.

OUR CREATIVE CONTROL SYSTEM COMBINES MODERN TECHNOLOGY WITH SIMPLICITY

The CREATIVE operating system combines technology with ease of use.

The touch screen simplifies the programming process of the ovens and enhances performance by reducing energy consumption and increasing cooking functions.

CREACTIVE

ASSISTED COOKING FUNCTION

CONTROL SYSTEM

No more doubts when picking the most suitable cooking function for your meals. Just select the recipe on the display and the oven will automatically initiate the best program. You can modify pre-set recipes to create your own by adjusting cooking times, weights and temperature.

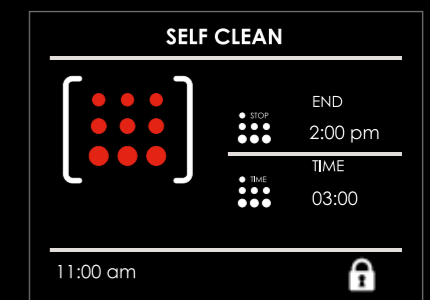
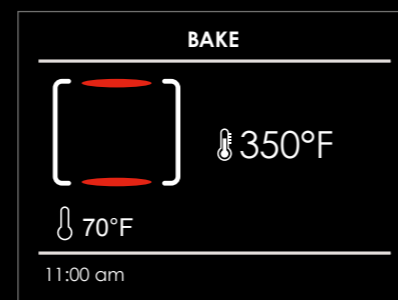
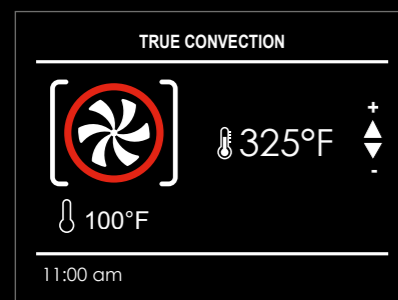

MULTI-LEVEL COOKING MODE

Internal heat remains constant throughout the oven, while aromas and flavors kept separate thanks to the fan assisted system.

BROIL

The most effective way to brown the exterior of a steak or roast while locking in juices to retain moisture and tenderness.

BAKE

Optimal for perfect baking: flavors blend effortlessly with consistent even heat throughout the oven cavity.

PIZZA MODE 590°F

Simultaneously bake two pizzas in only two and half minutes with the maximum temperature of 590°F (310°C).

CUSTOMIZABLE RECIPES

Cooking times and modes have been preprogrammed, but you can modify and customize your recipes to suit every palate and need.

SELF-CLEANING

The pyrolytic Self-Clean function, selected directly from the display, consists of heating the inside of the oven to very high temperatures in order to burn off any excess grease and food residue. At the end of the procedure, just wipe the remaining residue ashes with a cloth without the use of chemical detergents.

CREACTIVE OVENS

CREACTIVE OVEN CHARACTERISTICS

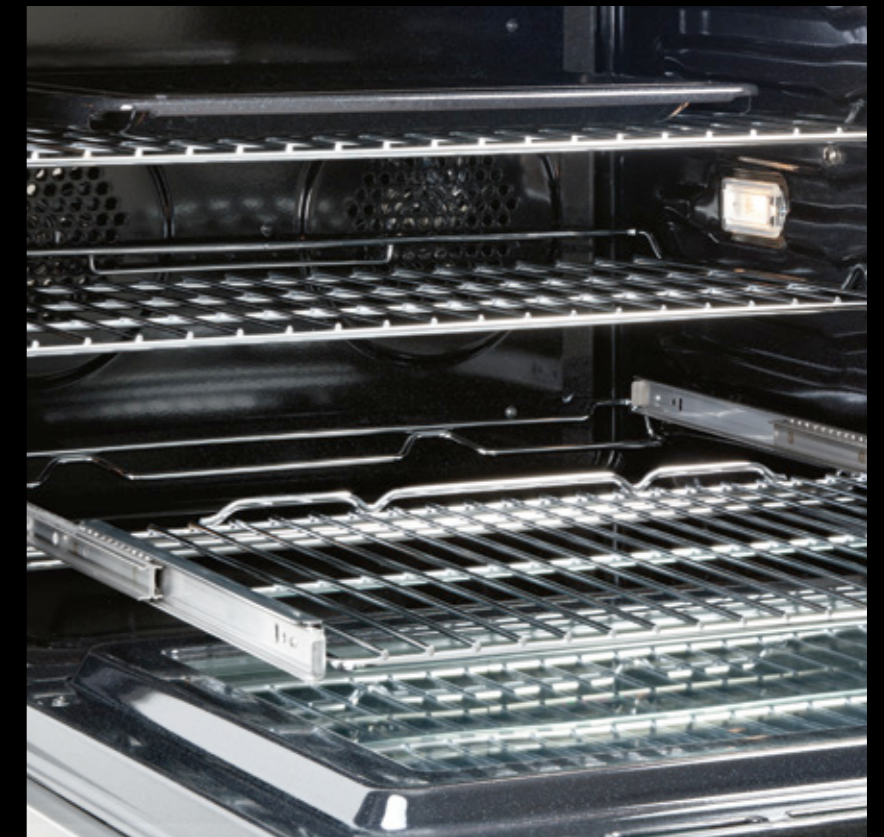

EXTRA LARGE CAVITY

Imagine the efficiency of being able to use multiple levels of a huge oven at once. We consider it an advantage, don't you?

HALOGEN LIGHTS

700 series ovens have 3 lights 20-watt halogen bulbs provide plenty of light for easy viewing.

CONCEALED BAKE ELEMENTS

The concealed heating element and large broiler make it possible to cook and save energy at the same time.

PYROLYTIC SELF-CLEAN

Simple, hassle free cleaning. At the end of the self-clean cycle, simply wipe away residue with a damp cloth

SAFETY FEATURE: COOL TOUCH DOOR

Rest assured, your hands are safe with us. Our cool-door technology has a proven guarantee.

TELESCOPIC RACK

Our fully retractable telescopic rack makes accessibility to your cooking more convenient.



FULGOR
MILANO

DISTINTO OVEN CREACTIVE

700 SERIES

A modern workhorse that marries style and innovation. With many preset cooking functions, the 700 series ovens help you prepare your meals with efficiency and ease. Child safety locks and cool touch doors ensure you and your family will be protected from high temperatures while cooking and during the self clean cycle. This series offers a versatile self clean mode, a dual convection system for high quality performance and an oversized oven space for big results. With 5 broil levels and a selection of accessories available to you, the 700 series ovens deliver both luxury and convenience.

COOKING

COOKING

OVEN 700 SERIES 30"











30" TOUCH CONTROL SINGLE OVEN - STAINLESS STEEL



CODE ID

F7SP30S1



-  **CREACTIVE COOKING SYSTEM**
-  **PIZZA COOKING MODE 590 °F**
-  Dual Convection
-  Self Clean Oven
-  Multi-level cooking
-  1 Telescopic Rack
-  Cool Touch Door
-  TFT Display
-  Meat Probe
-  Fast Pre-Heat
-  Interior Lighting

OVEN 700 SERIES 30"











30" TOUCH CONTROL DOUBLE OVEN - STAINLESS STEEL



CODE ID

F7DP30S1



-  **CREACTIVE COOKING SYSTEM**
-  **PIZZA COOKING MODE 590 °F**
-  Dual Convection
-  Self Clean Oven
-  Multi-level cooking
-  1 Telescopic Rack per oven
-  Cool Touch Door
-  TFT Display
-  Meat Probe
-  Fast Pre-Heat
-  Interior Lighting

SPECIFICATIONS

OVEN

Creative Touch Control System
 Dual True Convection
 Self-cleaning oven with Multifunction baking
 Black Porcelain enamel interior
 Cool to the touch
 Extra-large baking cavity and viewing area
 3 Halogen lights for flawless visibility
 Gross capacity 4.4 cu. ft.
 2 chromed racks
 1 telescopic rack
 Enameled Broiler Pan
 Lock Keys
 Door Lock

OVEN FUNCTIONS

Bake (cooking group)
 Broil
 Convection (cooking group)
 Keep Warm (cooking group)
 Recipes
 Classic Pizza Function 590°F
 Preset default temperature
 Preheat (display instantaneous temperature)
 Fast Preheat Mode
 Sabbath Mode
 Setting Temperature °C/°F
 Setting Weight Kg/lb
 Event Logs (for Service)
 Meat Probe
 Self-Clean

OPTIONAL ACCESSORIES

pag

FMTR630	30" Telesc. Rack	165
TECHNICAL DWG		178
TECHNICAL DATA		204

SPECIFICATIONS

Ovens

Creative Touch Control System
 Dual True Convection
 Self-cleaning oven with Multifunction baking
 Black Porcelain enamel interior
 Cool to the touch
 Extra-large baking cavity and viewing area
 3 Halogen lights for flawless visibility
 Gross capacity 4.4 cu. ft.
 2 chromed racks
 1 telescopic rack per oven
 Enameled Broiler Pan
 Lock Keys
 Door Lock

OVEN FUNCTIONS

Bake (cooking group)
 Broil
 Convection (cooking group)
 Keep Warm (cooking group)
 Recipes
 Classic Pizza Function 590°F
 Preset default temperature
 Preheat (display instantaneous temperature)
 Fast Preheat Mode
 Sabbath Mode
 Setting Temperature °C/°F
 Setting Weight Kg/lb
 Event Logs (for Service)
 Meat Probe (only upper oven)
 Self-Clean

OPTIONAL ACCESSORIES

pag

FMTR630	30" Telesc. Rack	165
TECHNICAL DWG		178
TECHNICAL DATA		205

OVEN 700 SERIES 30"











30" TOUCH CONTROL SINGLE OVEN - BLACK GLASS



CODE ID

F7SP30B1



-  CREACTIVE COOKING SYSTEM
-  PIZZA COOKING MODE 590 °F
-  Dual Convection
-  Self Clean Oven
-  Multi-level cooking
-  1 Telescopic Rack
-  Cool Touch Door
-  TFT Display
-  Meat Probe
-  Fast Pre-Heat
-  Interior Lighting

SPECIFICATIONS

OVEN

Creative Touch Control System
 Dual True Convection
 Self-cleaning oven with Multifunction baking
 Black Porcelain enamel interior
 Cool to the touch
 Extra-large baking cavity and viewing area
 3 Halogen lights for flawless visibility
 Gross capacity 4.4 cu. ft.
 2 chromed racks
 1 telescopic rack
 Enameled Broiler Pan
 Lock Keys
 Door Lock

OVEN FUNCTIONS

Bake (cooking group)
 Broil
 Convection (cooking group)
 Keep Warm (cooking group)
 Recipes
 Classic Pizza Function 590°F
 Preset default temperature
 Preheat (display instantaneous temperature)
 Fast Preheat Mode
 Sabbath Mode
 Setting Temperature °C/°F
 Setting Weight Kg/lb
 Event Logs (for Service)
 Meat Probe
 Self-Clean

OPTIONAL ACCESSORIES

pag

FMTR630 30" Telesc. Rack 165

TECHNICAL DWG 178

TECHNICAL DATA 204

OVEN 700 SERIES 30"











30" TOUCH CONTROL DOUBLE OVEN - BLACK GLASS



CODE ID

F7DP30B1



-  CREACTIVE COOKING SYSTEM
-  PIZZA COOKING MODE 590 °F
-  Dual Convection
-  Self Clean Oven
-  Multi-level cooking
-  1 Telescopic Rack per oven
-  Cool Touch Door
-  TFT Display
-  Meat Probe
-  Fast Pre-Heat
-  Interior Lighting

SPECIFICATIONS

OVENS

Creative Touch Control System
 Dual True Convection
 Self-cleaning oven with Multifunction baking
 Black Porcelain enamel interior
 Cool to the touch
 Extra-large baking cavity and viewing area
 3 Halogen lights for flawless visibility
 Gross capacity 4.4 cu. ft.
 2 chromed racks
 1 telescopic rack per oven
 Enameled Broiler Pan
 Lock Keys
 Door Lock

OVEN FUNCTIONS

Bake (cooking group)
 Broil
 Convection (cooking group)
 Keep Warm (cooking group)
 Recipes
 Classic Pizza Function 590°F
 Preset default temperature
 Preheat (display instantaneous temperature)
 Fast Preheat Mode
 Sabbath Mode
 Setting Temperature °C/°F
 Setting Weight Kg/lb
 Event Logs (for Service)
 Meat Probe (only upper oven)
 Self-Clean

OPTIONAL ACCESSORIES

pag

FMTR630 30" Telesc. Rack 165

TECHNICAL DWG 178

TECHNICAL DATA 205

OVEN 700 SERIES 30"











30" TOUCH CONTROL SINGLE OVEN - WHITE GLASS



CODE ID

F7SP30W1



-  **CREACTIVE COOKING SYSTEM**
-  **PIZZA COOKING MODE 590 °F**
-  Dual Convection
-  Self Clean Oven
-  Multi-level cooking
-  1 Telescopic Rack
-  Cool Touch Door
-  TFT Display
-  Meat Probe
-  Fast Pre-Heat
-  Interior Lighting

SPECIFICATIONS

OVEN

Creative Touch Control System
 Dual True Convection
 Self-cleaning oven with Multifunction baking
 Black Porcelain enamel interior
 Cool to the touch
 Extra-large baking cavity and viewing area
 3 Halogen lights for flawless visibility
 Gross capacity 4.4 cu. ft.
 2 chromed racks
 1 telescopic rack
 Enameled Broiler Pan
 Lock Keys
 Door Lock

OVEN FUNCTIONS

Bake (cooking group)
 Broil
 Convection (cooking group)
 Keep Warm (cooking group)
 Recipes
 Classic Pizza Function 590°F
 Preset default temperature
 Preheat (display instantaneous temperature)
 Fast Preheat Mode
 Sabbath Mode
 Setting Temperature °C/°F
 Setting Weight Kg/lb
 Event Logs (for Service)
 Meat Probe
 Self-Clean

OPTIONAL ACCESSORIES

pag

FMTR630 30" Telesc. Rack 165

TECHNICAL DWG 178

TECHNICAL DATA 204

OVEN 700 SERIES 30"











30" TOUCH CONTROL DOUBLE OVEN - WHITE GLASS



CODE ID

F7DP30W1



-  **CREACTIVE COOKING SYSTEM**
-  **PIZZA COOKING MODE 590 °F**
-  Dual Convection
-  Self Clean Oven
-  Multi-level cooking
-  1 Telescopic Rack per oven
-  Cool Touch Door
-  TFT Display
-  Meat Probe
-  Fast Pre-Heat
-  Interior Lighting

SPECIFICATIONS

OVENS

Creative Touch Control System
 Dual True Convection
 Self-cleaning oven with Multifunction baking
 Black Porcelain enamel interior
 Cool to the touch
 Extra-large baking cavity and viewing area
 3 Halogen lights for flawless visibility
 Gross capacity 4.4 cu. ft.
 2 chromed racks
 1 telescopic rack per oven
 Enameled Broiler Pan
 Lock Keys
 Door Lock

OVEN FUNCTIONS

Bake (cooking group)
 Broil
 Convection (cooking group)
 Keep Warm (cooking group)
 Recipes
 Classic Pizza Function 590°F
 Preset default temperature
 Preheat (display instantaneous temperature)
 Fast Preheat Mode
 Sabbath Mode
 Setting Temperature °C/°F
 Setting Weight Kg/lb
 Event Logs (for Service)
 Meat Probe (only upper oven)
 Self-Clean

OPTIONAL ACCESSORIES

pag

FMTR630 30" Telesc. Rack 165

TECHNICAL DWG 178

TECHNICAL DATA 205



FULGOR
MILANO

DISTINTO OVEN 400 SERIES

A sleek European design and flush installation, the 400 series oven shares the same body and soul of the 700 series oven, offering many of the same professional features while providing tremendous value. Available only in a single oven configuration, this series offers an oversized oven capacity, multi pass broil, European convection, concealed bake elements and 8 baking functions; all of which are controlled by an easy to use and extremely reliable control system.

The Athena XS control gives the home chef complete control via easy to use and intuitive controls making this oven a great choice as a primary or secondary oven for a variety of kitchen designs and applications.

OVEN 400 SERIES 30"



CODE ID

OVEN 400 SERIES 30"

F4SP30S1



-  True Convection
-  Self Clean Oven
-  Multi-level cooking
-  Cool Touch Door
-  Interior Lighting

SPECIFICATIONS

OVEN

Knob and electronic controls
Single fan true convection
Self-cleaning oven with Multifunction baking
Black Porcelain enamel interior
Cool to the touch
Extra-large baking cavity and viewing area
3 Halogen lights for flawless visibility
Gross capacity 4.4 cu. ft.
2 chromed racks
Enameled Broiler Pan

OVEN FUNCTIONS

Convection Bake
Convection Broil
Convection Roast
Bake
Broil
Thaw (Defrost)
Self-Clean

OPTIONAL ACCESSORIES

pag

FMTR630 30" Telesc. Rack 165

TECHNICAL DWG 178

TECHNICAL DATA 206

DRAWER 700 SERIES 30"

30" WARMING DRAWER STAINLESS STEEL DOOR

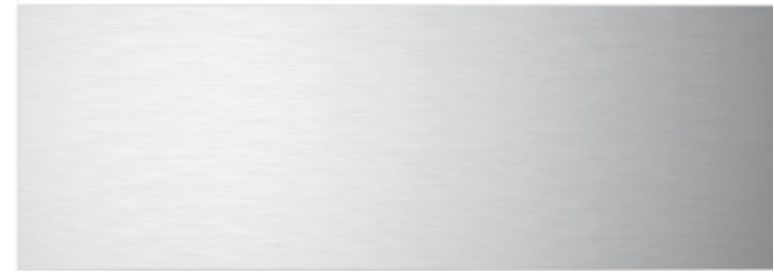







NEW



CODE ID

F7DWD30S1

-  Sliding Telescopic Rails
-  Keep Warm Function
-  Leavening
-  Slow Cooking
-  Thawing
-  Push Opening

DRAWER 700 SERIES 30"

30" WARMING DRAWER OVERLAY PANEL

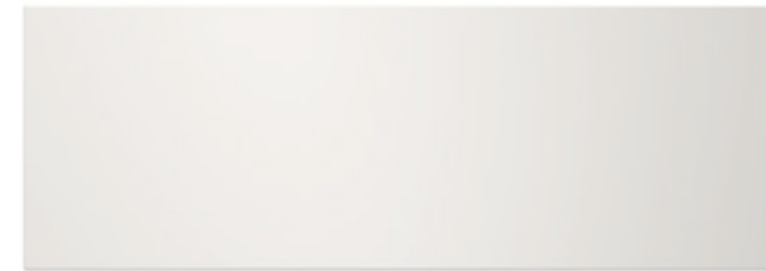







NEW



CODE ID

F7IWD30O1

-  Sliding Telescopic Rails
-  Keep Warm Function
-  Leavening
-  Slow Cooking
-  Thawing
-  Push Opening

SPECIFICATIONS

WARMING DRAWER

Knob Control
 Heavy Duty full extendable telescopic rails
 Large capacity 2,1 cu. ft.
 Convection heating system for a more heating distribution
 All stainless steel structure
 Warming Temperature range; min. 86 °F up to 190 °F
 Push-Pull system to open and close door
 2 Internal lights
 Non-slip rubber mat

DRAWER 30" FUNCTIONS

Pre-heat dishes
 Pre-heat coffee cups
 Keep warm ready food
 Defrosting
 Leavening dough
 Slow cooking min. 86 °F up to 190 °F

OPTIONAL ACCESSORIES

pag

TECHNICAL DWG

178

TECHNICAL DATA

207

SPECIFICATIONS

WARMING DRAWER

Knob Control
 Installation with Overlay Panel
 Heavy Duty full extendable telescopic rails
 Large capacity 2,1 cu. ft.
 Convection heating system for a more heating distribution
 All stainless steel structure
 Warming Temperature range; min. 86 °F up to 190 °F
 Push-Pull system to open and close door
 2 Internal lights
 Non-slip rubber mat

DRAWER 30" FUNCTIONS

Pre-heat dishes
 Pre-heat coffee cups
 Keep warm ready food
 Defrosting
 Leavening dough
 Slow cooking min. 86 °F up to 190 °F

OPTIONAL ACCESSORIES

pag

TECHNICAL DWG

179

TECHNICAL DATA

207

FULGOR
MILANO

DISTINTO OVEN 100 SERIES

A standard-setting series with first-class performance. Many preset cooking functions help you prepare your meals with efficiency and ease. The fastest and most versatile self-clean mode available, featuring an automatic door-latch system.

Child safety locks and cool-touch doors protect you and your family from high temperatures while cooking and during the self-clean cycle. Compact oven cavity dimensions fit in any kitchen and reduce energy consumption while providing ample space for all your cooking needs. A selection of accessories is available for your convenience.

FULGOR
MILANO

OVEN 100 SERIES 30"

30" MULTIFUNCTION SELF-CLEAN OVEN



CODE ID

F1SP30S1



-  True Convection
-  Self Clean Oven
-  Multi-level cooking
-  Cool Touch Door
-  Interior Lighting

OVEN 100 SERIES 24"

24" MULTIFUNCTION SELF-CLEAN OVEN



CODE ID

F1SP24S2



-  True Convection
-  Self Clean Oven
-  Multi-level cooking
-  Cool Touch Door
-  Interior Lighting

SPECIFICATIONS

OVEN

Knob and electronic controls
 True Convection
 Self-cleaning oven with Multifunction baking
 Black Porcelain enamel interior
 2 Halogen lights
 Gross capacity 3.0 cu. ft.
 2 chromed racks
 Enameled Broiler Pan (basin + anti splash)

OVEN FUNCTIONS

Convection Bake
 Convection Broil
 Convection Roast
 Bake
 Broil
 Thaw (Defrost)
 Self-Clean

OPTIONAL ACCESSORIES

pag

FMTR 130	Telescopic rack	165
TECHNICAL DWG		179
TECHNICAL DATA		208

SPECIFICATIONS

OVEN

Knob and electronic controls
 True Convection
 Self-cleaning oven with Multifunction baking
 Black Porcelain enamel interior
 1 Halogen light
 Gross capacity 2.6 cu. ft.
 2 chromed racks
 Enameled Broiler Pan (basin + anti splash)

OVEN FUNCTIONS

Convection Bake
 Convection Broil
 Convection Roast
 Bake
 Broil
 Thaw (Defrost)
 Self-Clean

OPTIONAL ACCESSORIES

pag

FMTELG	Telescopic rack	165
TECHNICAL DWG		179
TECHNICAL DATA		208

OVEN 100 SERIES 30"

30" MULTIFUNCTION EASY-CLEAN OVEN



CODE ID

F1SM30S1



-  Defrost
-  Multi-level cooking
-  Cool Touch Door
-  Interior Lighting

OVEN 100 SERIES 24"

24" MULTIFUNCTION EASY-CLEAN OVEN



CODE ID

F1SM24S2



-  True Convection
-  Multi-level cooking
-  Cool Touch Door
-  Interior Lighting

SPECIFICATIONS

OVEN

Knob and electronic controls
Black Porcelain enamel interior
2 Halogen lights
Gross capacity 3.0 cu. ft.
2 chromed racks
Enameled Grill basin

OVEN FUNCTIONS

Convection Broil
Convection Roast
Bake
Broil
Pizza (Lower Conv. Bake)
Lower Bake
Thaw (Defrost)

OPTIONAL ACCESSORIES

pag

FMTR 130	Telescopic rack	165
TECHNICAL DWG		179
TECHNICAL DATA		209

SPECIFICATIONS

OVEN

Knob and electronic controls
True Convection
Black Porcelain enamel interior
1 Halogen light
Gross capacity 2.6 cu. ft.
2 chromed racks
Enameled Broiler Pan (basin + anti splash)

OVEN FUNCTIONS

Convection Bake
Convection Broil
Convection Roast
Bake
Broil
Lower Conv. Bake

OPTIONAL ACCESSORIES

pag

FMTELG	Telescopic rack	165
TECHNICAL DWG		179
TECHNICAL DATA		209

FULGOR
MILANO

DISTINTO GAS COOKTOPS 400 SERIES

The 400 series "Largo" cooktops utilize the most advanced technology available and combine this with a classic Italian design, resulting in a cooktop that not only performs magnificently but also looks spectacular. A design that lends itself to countless application possibilities, the 400 series cooktops also take cooking and maintenance needs into consideration.

All grates are separated in sizes that make them easy to handle and remove for cleaning. The burners are well oriented for ease of use, with unique configurations like a wok burner and fifth burner on a 30" unit, making this cook top one of the most versatile in the category. Explore the Largo cooktop family and enjoy the possibilities; buon appetito!

DISTINTO GAS COOKTOPS 400 SERIES



CONTINUOUS GRATE SURFACE

Move from one burner to the next with ease and safety.

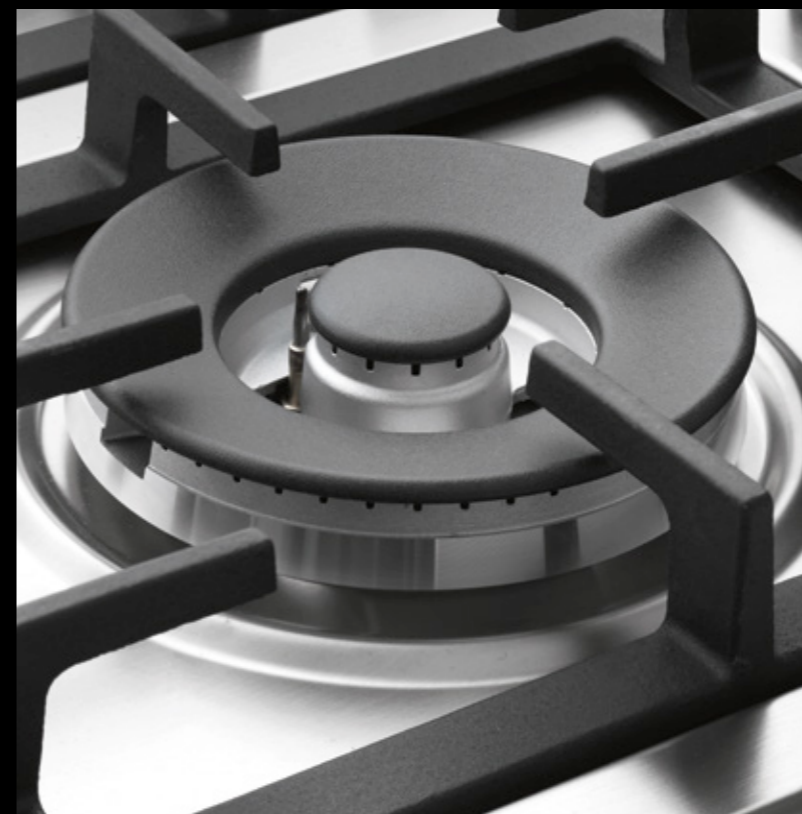

DUAL BURNER

Fulgor-Milano uses a dual-flame European-style sealed burner to deliver a wide range of heat.

SPACE FOR WOK

Our unique configurations allow you to have all the space needed for large pans or even a wok.



EUROPEAN SEALED BURNERS

Designed with only two removable parts, our sealed burners keep spills from leaking inside the cooktop. High quality aluminum.

COOKTOP 400 SERIES 44"





CODE ID

F4GK42S1

44" GAS COOKTOP



-  Heavy Duty Grates
-  Continuous Grate Surface
-  Dual Burner
-  Stainless Steel

COOKTOP 400 SERIES 36"



CODE ID

F4GK36S1

36" GAS COOKTOP



-  Heavy Duty Grates
-  Continuous Grate Surface
-  Dual Burner
-  Stainless Steel

SPECIFICATIONS

GAS COOKTOP

4 gas burners with 1 Dual Flame burner
Electronic Ignition and Re-ignition
Flame-out Sensing
Heavy duty cast iron grates

OPTIONAL ACCESSORIES

FMWOK	Wok ring	164
FMSIM	Simmer plate	164
FMSPR	Small Pot Adapter	164

TECHNICAL DWG 180

TECHNICAL DATA 210

SPECIFICATIONS

GAS COOKTOP

5 gas burners with 1 Dual Flame burner
Electric Re-ignition system
Flame-out Sensing
Heavy duty cast iron grates

OPTIONAL ACCESSORIES

FMWOK	Wok ring	164
FMSIM	Simmer plate	164
FMSPR	Small Pot Adapter	164

TECHNICAL DWG 180

TECHNICAL DATA 210

COOKTOP 400 SERIES 30"





30" GAS COOKTOP



CODE ID

F4GK30S1



-  Heavy Duty Grates
-  Continuous Grate Surface
-  Dual Burner
-  Stainless Steel

COOKTOP 400 SERIES 24"





24" GAS COOKTOP



CODE ID

F4GK24S1



-  Heavy Duty Grates
-  Continuous Grate Surface
-  Dual Burner
-  Stainless Steel

SPECIFICATIONS

GAS COOKTOP

5 gas burners with 1 Dual Flame burner
Electric Re-ignition system
Flame-out Sensing
Heavy duty cast iron grates

OPTIONAL ACCESSORIES

FMWOK	Wok Ring	164
FMSIM	Simmer Plate	164
FMSPR	Small Pot Adapter	164

TECHNICAL DWG 181

TECHNICAL DATA 211

SPECIFICATIONS

GAS COOKTOP

4 gas burners with 1 Dual Flame burner
Electric Re-ignition system
Flame-out Sensing
Heavy duty cast iron grates

OPTIONAL ACCESSORIES

FMWOK	Wok Ring	164
FMSIM	Simmer Plate	164
FMSPR	Small Pot Adapter	164

TECHNICAL DWG 181

TECHNICAL DATA 211

FULGOR
MILANO

DISTINTO
INDUCTION
COOKTOPS
700
SERIES

Our 700 series induction cooktops follow the same design criteria of all our Fulgor-Milano products; style, function, and performance are at the heart of this product. Like our radiant touch cooktops, the induction units are finished with a subtle yet elegant aluminum trim that exudes luxury while offering all of the features you expect from a premium cooking appliance. Our induction cooktops offer the power and control of a gas cooktop with the cleanability of a radiant cooktop, giving you the best of both worlds. From tempering fine chocolate, braising a classic Os-sobuco, or bringing a 15 quart stock pot to boil in minutes, the possibilities are endless with our induction technology.

DISTINTO INDUCTION COOKTOPS 700 SERIES



EXTRA LARGE ZONE AND BRIDGE ELEMENT

Maximum flexibility in how you use the cooktop.

SLIDE TOUCH CONTROLS

Each cooking zone has its own slide touch control for precise selection of power.

INDUCTION

The pan creating its own heat means cooking safely without compromise. Since there is no heat transfer from a conventional burner through the glass, induction cooking surfaces use the exact amount of energy needed - no more, no less!

FRAME

Aluminum frame stainless steel color: Sophisticated and functional! Adds a touch of elegance while protecting the glass edge.

LOW TEMPERATURE FUNCTION

Low enough to temper chocolate or hold delicate sauces without using a double boiler.

INDUCTION COOKTOPS 700 SERIES 36"









CODE ID

F7IT36S1

36" INDUCTION COOKTOP WITH BRUSHED ALUMINUM TRIM



-  Easy Clean Ceramic Glass
-  Slide Touch Control
-  Bridge Zone
-  Pan Detection system
-  Residual Heat Sensor
-  Frame Creative
-  Digital Minute Minder

INDUCTION COOKTOPS 700 SERIES 30"



CODE ID

F7IT30S1

30" INDUCTION COOKTOP WITH BRUSHED ALUMINUM TRIM



-  Easy Clean Ceramic Glass
-  Slide Touch Control
-  Pan Detection system
-  Residual Heat Sensor
-  Frame Creative
-  Digital Minute Minder

SPECIFICATIONS

INDUCTION COOKTOP

5 Induction cooking zones
 11" large cooking zone
 Bridge zone on the right side
 Elegant Ceramic glass surface
 Premium induction technology for unsurpassed performance
 Melt and Simmering Functions
 Residual heat and Power on Indicators
 Digital Minute Minder

Pot Detection System
 Child Lock Function
 Independent timer for each zone
 Pause Function
 Booster function for each cooking zone
 Failure Codes Indication
 Digital Display for Power Level
 Automatic Heat-up Time

OPTIONAL ACCESSORIES

pag

INDUKIT4 Pot Induction Adapter 166

TECHNICAL DWG 182

TECHNICAL DATA 212

SPECIFICATIONS

INDUCTION COOKTOP

4 Induction cooking zones
 11" cooking zone
 Elegant Ceramic glass surface
 Premium induction technology for unsurpassed performance
 Melt and Simmering Functions
 Residual heat and Power on Indicators
 Digital Minute Minder

Pot Detection System
 Child Lock Function
 Independent timer for each zone.
 Pause Function
 Booster function for each cooking zone
 Failure Codes Indication
 Digital Display for Power Level
 Automatic Heat-up Time

OPTIONAL ACCESSORIES

pag

INDUKIT4 Pot Induction Adapter 166

TECHNICAL DWG 182

TECHNICAL DATA 212

FULGOR
MILANO

DISTINTO
RADIANT
COOKTOPS
600
SERIES

Beautiful intuitive controls designed with elegance and precision. Radiant touch cooktops deliver quick and reliable performance with maximum flexibility. Touch controls with patented Peacock control sliding bar for power-level selection and fast boil with automatic power reduction.

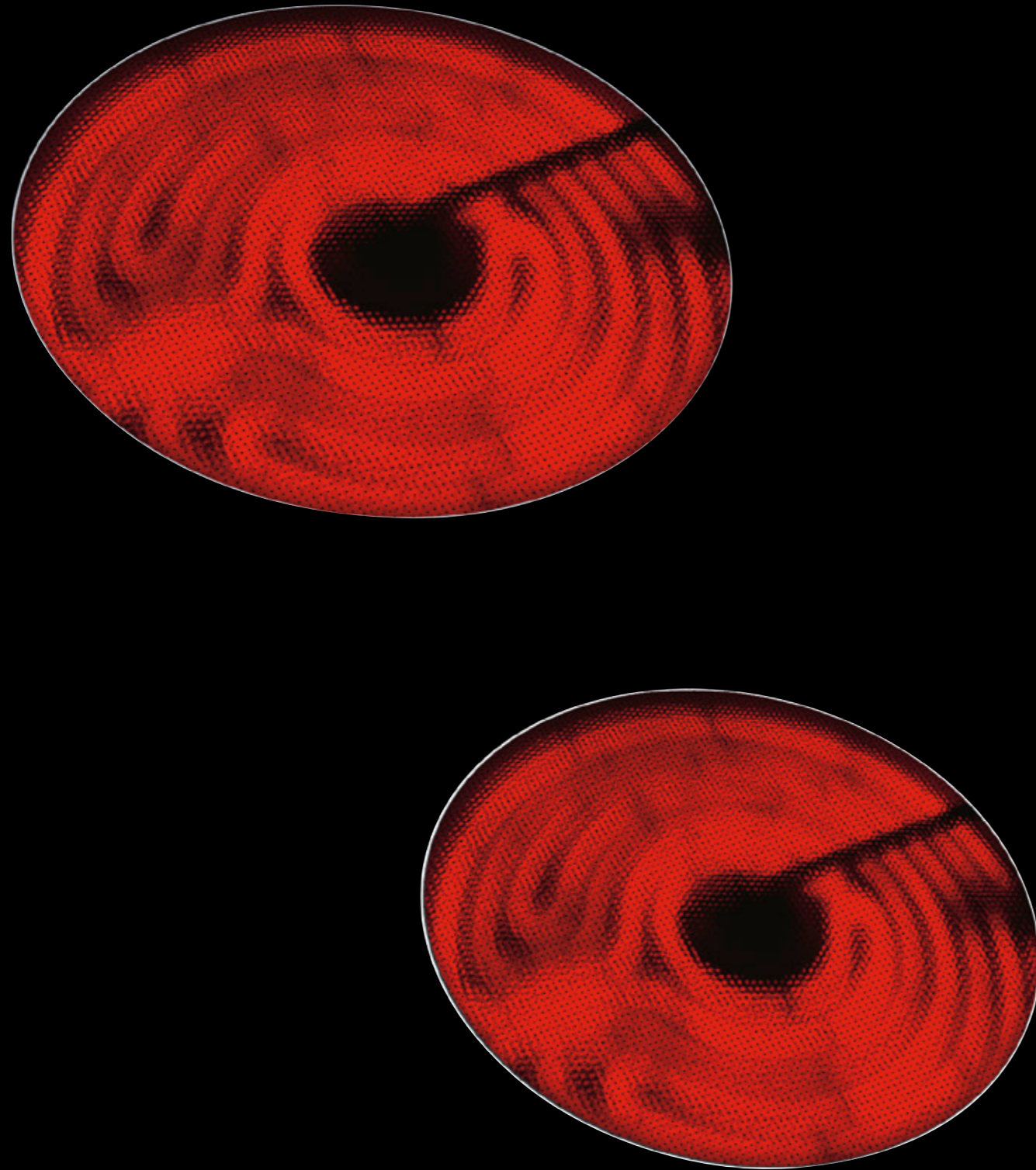

DISTINTO RADIANT COOKTOPS 600 SERIES

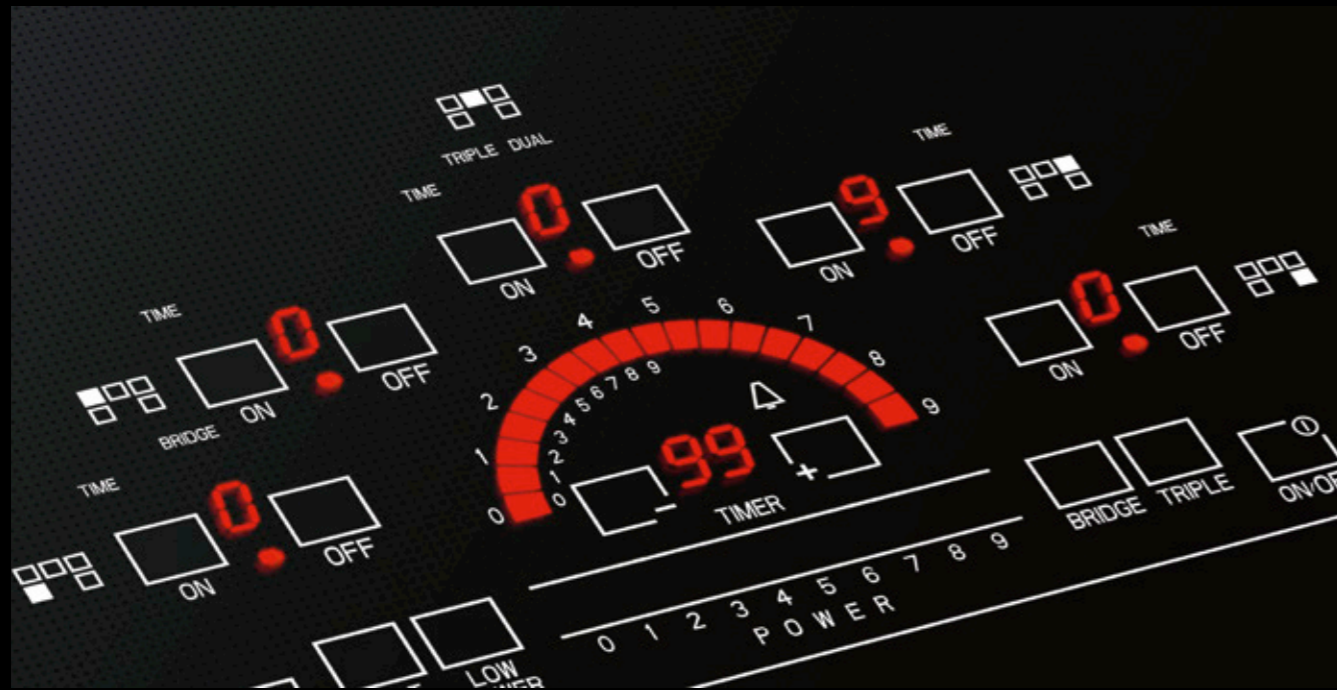

ELECTRONIC CONTROL

Fine-tuning of lower temperatures plus timer function is standard with our slide touch control bar and "Peacock" power display.



FRAME

Polished aluminum frame:
Sophisticated and functional!

RADIANT COOKTOP 600 SERIES 36"









CODE ID

F6RT36S2

36" RADIANT COOKTOP WITH TOUCH CONTROL WITH BRUSHED ALUMINUM TRIM



-  Easy Clean Ceramic Glass
-  Slide Touch Control
-  Bridge Zone
-  Triple Radiant
-  Timer
-  Residual Heat Sensor
-  Frame Creative

RADIANT COOKTOP 600 SERIES 30"









CODE ID

F6RT30S2

30" RADIANT COOKTOP WITH TOUCH CONTROL WITH BRUSHED ALUMINUM TRIM



-  Easy Clean Ceramic Glass
-  Slide Touch Control
-  Double Radiant
-  Triple Radiant
-  Timer
-  Residual Heat Sensor
-  Frame Creative

SPECIFICATIONS

RADIANT COOKTOP

Digital Display for Power Level
 Low Power Scale for Delicate Cooking
 Control Display Lock
 Automatic Fast Boil Function
 Power and Hot surface Indication
 Timer Functions
 Timer Display
 Acoustic Buzzer
 Independent timer for each zone
 Booster function for each cooking zone
 Failure Codes Indication

OPTIONAL ACCESSORIES

pag

TECHNICAL DWG

183

TECHNICAL DATA

214

SPECIFICATIONS

RADIANT COOKTOP

Digital Display for Power Level
 Low Power Scale for Delicate Cooking
 Control Display Lock
 Automatic Fast Boil Function
 Power and Hot surface Indication
 Timer Functions
 Timer Display
 Acoustic Buzzer
 Independent timer for each zone.
 Booster function for each cooking zone
 Failure Codes Indication

OPTIONAL ACCESSORIES

pag

TECHNICAL DWG

183

TECHNICAL DATA

215

DISTINTO RADIANT COOKTOPS 300 SERIES

Our 300 series cooktops offer the same elegant European design and family line as our radiant touch and induction cooktops but in a package that offers great value and performance to the consumer. The manual controls are reliable and accurate and continue to be the most user friendly of all control systems available today. Even the most discerning cooks will be impressed with the functionality and performance of this mainstay. Like all Fulgor-Milano cooktops the 300 series offers a shallow profile for countless installation options.

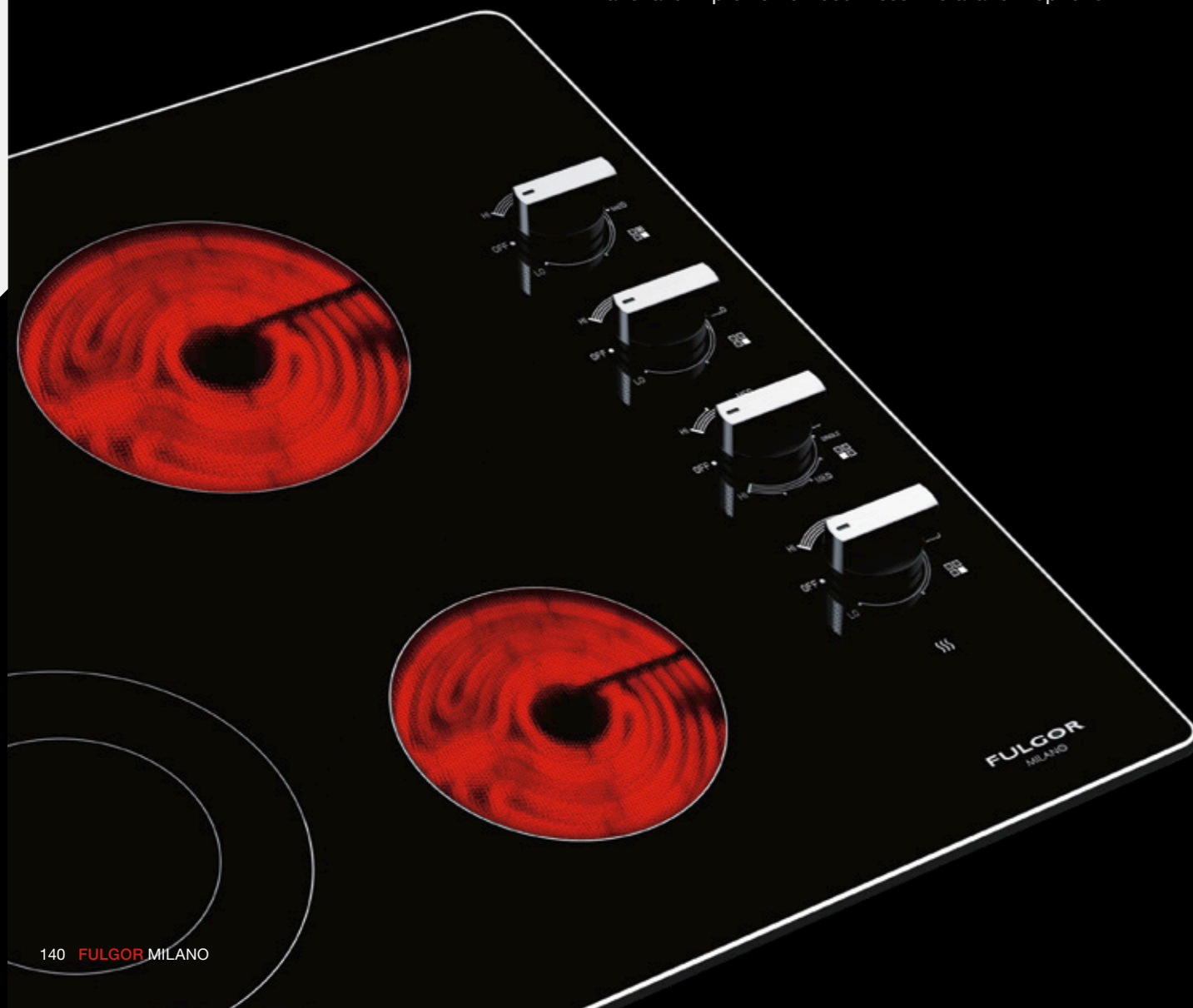

RADIANT COOKTOPS 300 SERIES 24"





24" RADIANT COOKTOP WITH KNOB CONTROL WITH BRUSHED ALUMINUM TRIM

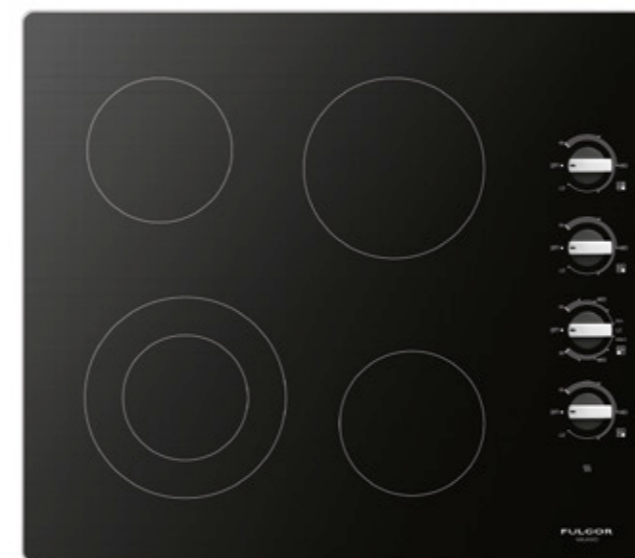

CODE ID

F3RK24S2



-  Easy Clean Ceramic Glass
-  Double Radiant
-  Residual Heat Sensor
-  Frame Creative



SPECIFICATIONS

RADIANT COOKTOP

Power on Indication
Hot surface Indication

OPTIONAL ACCESSORIES pag

TECHNICAL DWG 183
TECHNICAL DATA 216



FULGOR
MILANO

DISTINTO
HOODS
600-400
SERIES

As important as it is to have a cooking product give you the performance to create all of your cooking masterpieces, effective ventilation is essential to remove cooking odors and excessive heat from the kitchen. To compliment our line of cooking products we offer a complete range of ventilation products which are also hand crafted in Italy and meet all of the criteria one would expect. Quality, performance, fit and finish, are all embodied in our ventilation products. Let us help you find the best solution to meet your individual performance requirements and design needs.

DISTINTO
HOODS
600-400
SERIES



BAFFLE FILTER

Stainless steel and dishwasher safe, our baffle filters allow for perfect filtering of cooking vapors and grease while still offering efficient suction.

LED

For perfect illumination of your cooking surface.

PERFECT QUALITY

Smooth weld finished corner surface.

HOOD 600 SERIES 34"

34" INSERT HOOD



CODE ID

F6BP34S1



CFM max 600



LED Lighting



Noise Level 69 (dB)



Ceiling installation

HOOD 400 SERIES 28"

28" INSERT HOOD



CODE ID

F4BP28S1



CFM max 600



LED Lighting



Noise Level 69 (dB)



Ceiling installation

SPECIFICATIONS

INSERT HOOD

600 CFM
69 dB sound rating
Pro Baffle Filters
LED Lighting

OPTIONAL ACCESSORIES

pag

FMFIL Charcoal Filters 166

TECHNICAL DWG 184

TECHNICAL DATA 217

SPECIFICATIONS

INSERT HOOD

600 CFM
69 dB sound rating
Baffle Filters
LED Lighting

OPTIONAL ACCESSORIES

pag

FMFIL Charcoal Filters 166

TECHNICAL DWG 184

TECHNICAL DATA 217

HOOD 400 SERIES 36"

36" UNDERCABINET HOOD



CODE ID

F4UC36S1



CFM max 450



LED Lighting



Noise Level 69 (dB)



Wall hung installation

HOOD 400 SERIES 30"

30" UNDERCABINET HOOD



CODE ID

F4UC30S1



CFM max 450



LED Lighting



Noise Level 69 (dB)



Wall hung installation

SPECIFICATIONS

INSERT HOOD

450 CFM
69 dB sound rating
Baffle Filters
LED Lighting

OPTIONAL ACCESSORIES

pag

FMFIL Charcoal filters 186

TECHNICAL DWG 184

TECHNICAL DATA 217

SPECIFICATIONS

INSERT HOOD

450 CFM
69 dB sound rating
Baffle Filters
LED Lighting

OPTIONAL ACCESSORIES

pag

FMFIL Charcoal filters 186

TECHNICAL DWG 184

TECHNICAL DATA 217

FULGOR
MILANO

DISTINTO FRIDGE & WINE

COLD TEMP. UNDER CONTROL.

The fridge was developed to be optimized for complete integration and designed to offer maximum storage capacity. The dual-movement hinges ensure that all the fridge drawers extend fully when open. The interior is a brilliant white, for striking effect.

Fulgor Milano Wine Cellars store wine under ideal conditions, designed to eliminate the four enemies of wine: heat, humidity, light, and vibration. With all of the functional and aesthetic features of our refrigerators, significant attention was paid to the added features of customized humidity and temperature control, ensuring the optimal environment for aging your wine collection.

DISTINTO FRIDGE & WINE

DUOPRO

Dual variable speed compressors and two dedicated evaporators ensure smooth, quiet, energy efficient operation.

SOFT-CLOSING SYSTEM

State-of-the-art mechanisms ensure the slow and silent closing of drawers and doors every time.



INTERIOR CONVENIENCE

Brilliant white aluminum interior walls combine with a powerful LED lighting system to create a striking effect and a bright interior. With a state of the art adjustable glass shelving system and door bins, convenience is key while the advanced refrigeration system keeps your food fresher longer.

OPTIVISION

The Optivision lighting system uses modern LED technology to ensure an optimal view of the interior. Ten LED arrays light the refrigerator compartment from above, while 7 individual spot lights illuminate distinct areas of the fridge and fresh food compartments and Flexzone drawer.

CUSTOM SIZED ICE

With the Ice Maker menu you can choose the size of the ice cubes produced automatically between large and medium.

WINE CELLAR

The electronic control enables the preferred humidity level to be chosen, between high, medium and low, ensuring the correct preservation of corks, a fundamental element for the storage of fine wine. Not just tasting temperature: the Cave storage compartment can also be used to store red wines to be aged over a long period thanks to the accurate temperature and humidity control.

BUILT-IN WINE CELLAR 24"

24" PROFESSIONAL BUILT-IN WINE CELLAR



NEW













CODE ID

F71BW24O1-R (RIGHT DOOR)

CODE ID

F71BW24O1-L (LEFT DOOR)

-  Deep-freezing
-  Hot air ventilation
-  Rapid Deep Freezing
-  LED lighting
-  Noise Level 41 (dB)
-  Integrated Installation
-  Holiday Mode
-  Triple Panel Door
-  54 Bottles Capacity
-  Overlay Panel

SPECIFICATIONS

WINE CELLAR

Cave Storage Compartment,
Natural Wood Shelves, for 36 bottles
Wine Celler Compartment,
Natural Wood Shelves, for 18 bottles
TriplePlay Refrigeration
Total No Frost
LED Lighting
Brilliant white aluminium interior
TriZone Bottom Drawer

OPTIONAL ACCESSORIES

pag

TECHNICAL DWG

185

TECHNICAL DATA

219

Note: Handle kit: Distinto Fridge and Wine Celler handles are to be supplied by installer

BUILT-IN FRIDGE 36"

36" PROFESSIONAL BUILT-IN FRIDGE

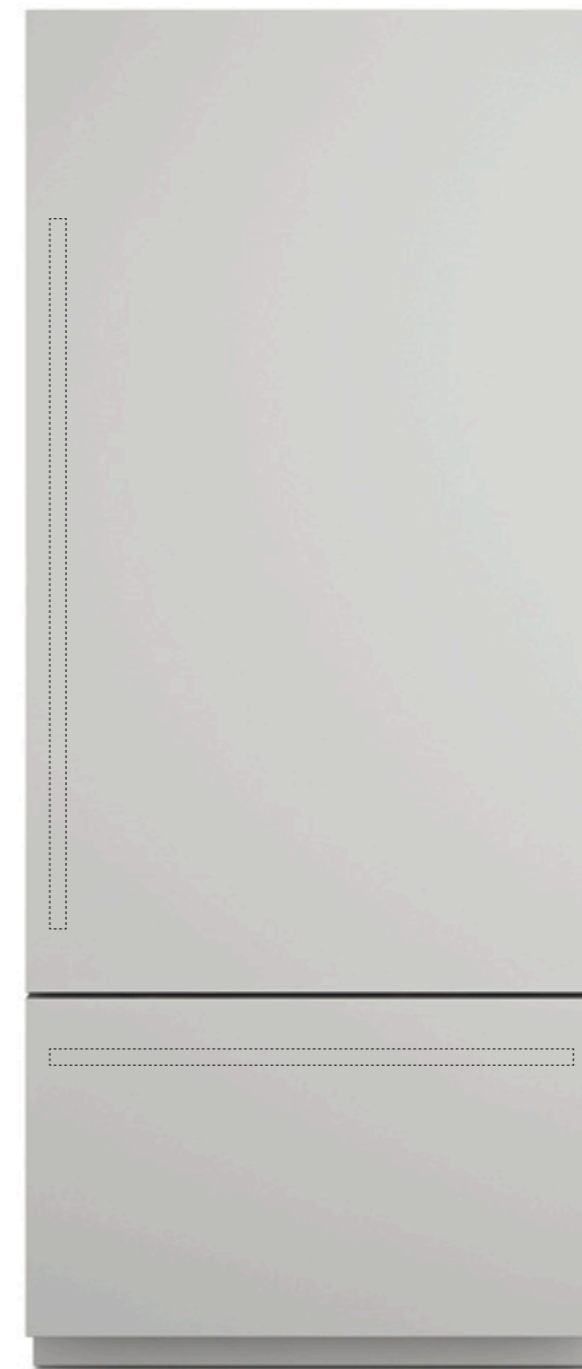

NEW













CODE ID

F71BM36O1-L (LEFT DOOR)

CODE ID

F71BM36O1-R (RIGHT DOOR)

-  Cool Zone 0°C
-  Deep-freezing
-  Hot air ventilation
-  Total No Frost
-  Rapid Deep Freezing
-  LED lighting
-  Noise Level 41 (dB)
-  Integrated Installation
-  Holiday Mode
-  Ice Maker
-  Overlay Panel

SPECIFICATIONS

FRIDGE

Fridge Compartment
TriZone Bottom Drawer
Total No Frost
Stainless Steel Drawers
Ice Maker with ice tray
LED Lighting
Brilliant white aluminium interior

OPTIONAL ACCESSORIES

pag

TECHNICAL DWG

185

TECHNICAL DATA

218

Note: Handle kit: Distinto Fridge and Wine Celler handles are to be supplied by installer



FULGOR
MILANO

DISTINTO DISHWASHERS **600** SERIES

We love preparing meals for family and friends, but with that comes the clean up. To make life easier, Fulgor Milano offers three distinct styles of dishwashers maintaining the design integrity of your kitchen. Choose between Professional, Distinto, or Integrated which will accept a custom panel to match your cabinets. Our Italian built dishwashers offer all of the features that have become the standard in premium dishwashers models on the market today. Quiet performance, stainless interior, flow-through heater, adjustable upper racks and amazing washing results are just some of the features you can expect from our dishwashers.

DISTINTO DISHWASHERS 600 SERIES

AQUASTOP

Have peace of mind with the Aquastop feature that detects and prevents water leaks.

CUSTOMIZABLE

Offers flexibility while arranging dishes for wash.



UPPER BASKET

Designed for better accommodation of different sizes of cups and glasses.

LOWER BASKET

Robust and roomy, the lower basket can accommodate large pots.

MICRO FILTER

With three levels of filtering, our micro filter gives you the best cleaning performance.

WATER SOFTENER

For flawless cleaning even with hard water.

ADJUSTABILITY

The height-adjustable upper rack easily accommodates a variety of glassware sizes and makes room for larger items below.

DISHWASHER 600 SERIES 24"

24" INTEGRATED DISHWASHER WITH STAINLESS STEEL EXTERIOR



CODE ID

F6DW24SS1



Noise Level 49 (dB)



Steel Tub



Fast Wash Cycle

DISHWASHER 600 SERIES 24"

24" FULLY INTEGRATED DISHWASHER



CODE ID

F6DW24FI1



Noise Level 49 (dB)



Steel Tub



Fast Wash Cycle

SPECIFICATIONS

INTEGRATED DISHWASHER

Quiet plus – 49dB
Stainless steel interior tub
10 wash cycles
Fast wash cycles
Adjustable height upper rack
13 place settings
Concealed heating element
Extreme wash (sanitization)

OPTIONAL ACCESSORIES

pag

TECHNICAL DWG

186

TECHNICAL DATA

220

SPECIFICATIONS

INTEGRATED DISHWASHER

Quiet plus – 49dB
Stainless steel interior tub
10 wash cycles
Fast wash cycles
Adjustable height upper rack
13 place settings
Concealed heating element
Extreme wash (sanitization)
Custom overlay panel-ready

OPTIONAL ACCESSORIES

pag

TECHNICAL DWG

186

TECHNICAL DATA

221

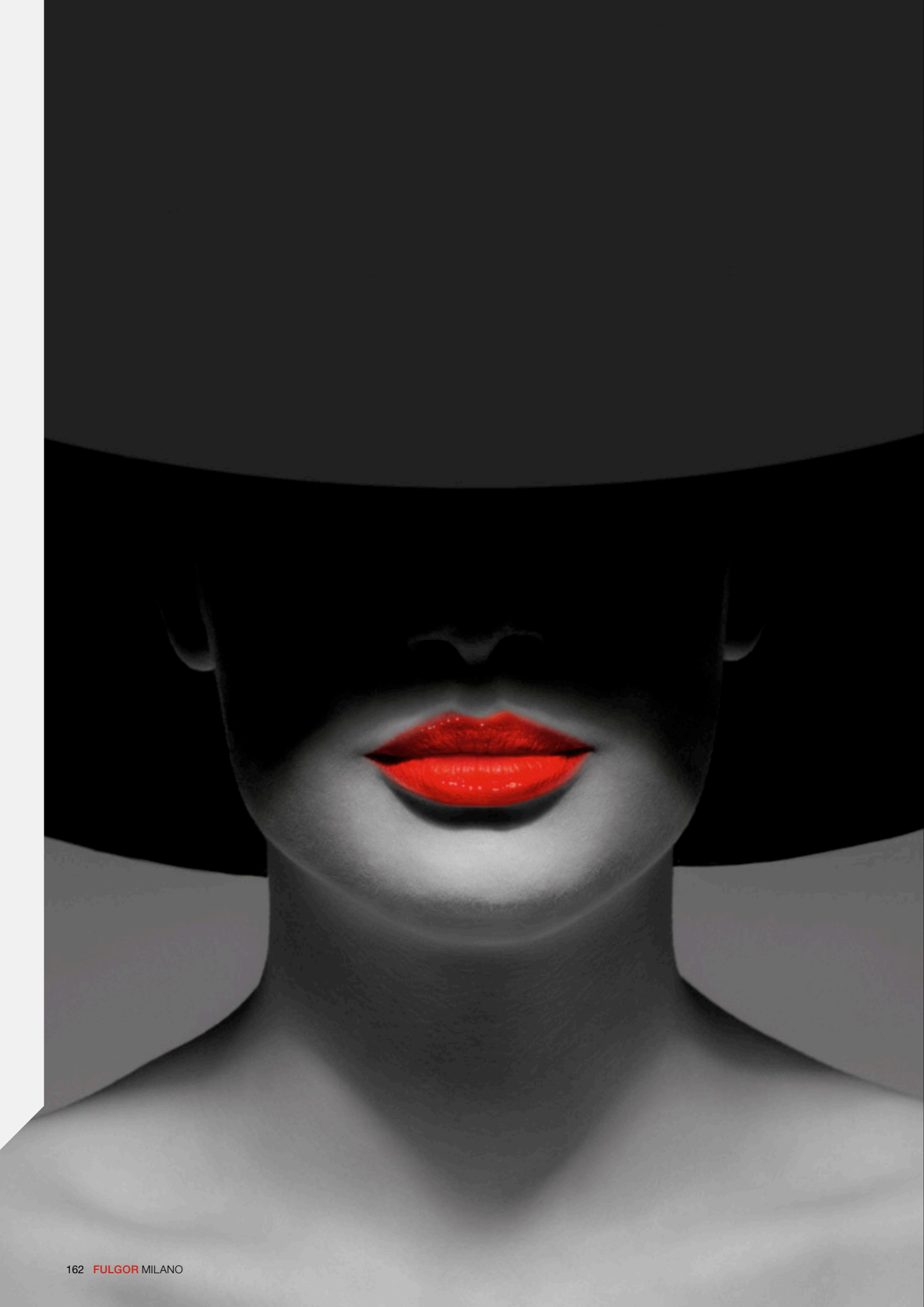

FULGOR
MILANO

DISTINTO
ACCESSORIES
OPTIONAL

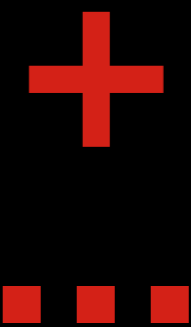



Small pot reduction CODE **FMSPR**

Uniquely creactiveed accessory allows you to use pans smaller than 4 inches on a stable, flat cooking surface



Wok ring CODE **FMWOK**

For best results with a wok, use this accessory with the high-BTU burner specifically creactiveed for wok cooking.



Simmer plate CODE **FMSIM**

The cast-iron simmer plate provides a steady simmer temperature, evenly distributed across a stable heating surface.

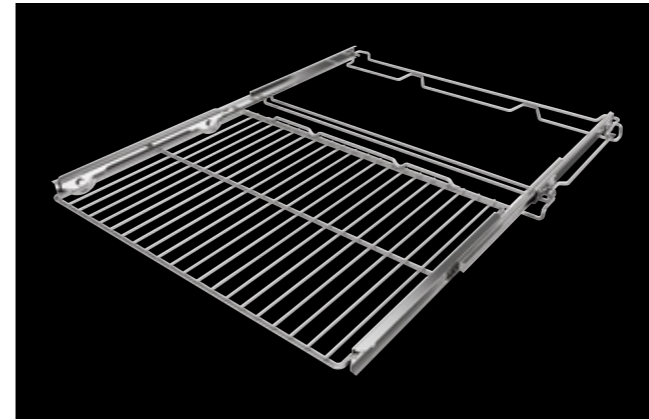

30" Telescopic Oven Rack CODE **FMTR630**

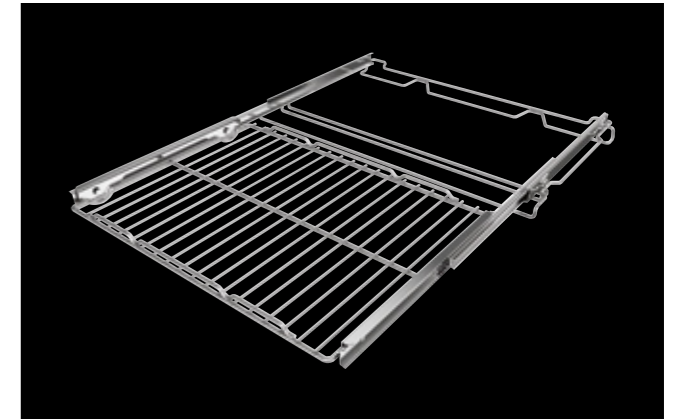

30" Telescopic Oven Rack CODE **FMTR130**



24" Telescopic guides CODE **FMTELG**

DISTINTO INDUCTION

OPTIONAL ACCESSORIES



Trilaminare magnetic plates for non induction pots CODE **INDUKIT4**

DISTINTO HOOD

OPTIONAL ACCESSORIES



Charcoal filters (for recirculating installations) CODE **FMFIL**

NEW

DISTINTO CONSERVATION / WINE COOLER

OPTIONAL ACCESSORIES

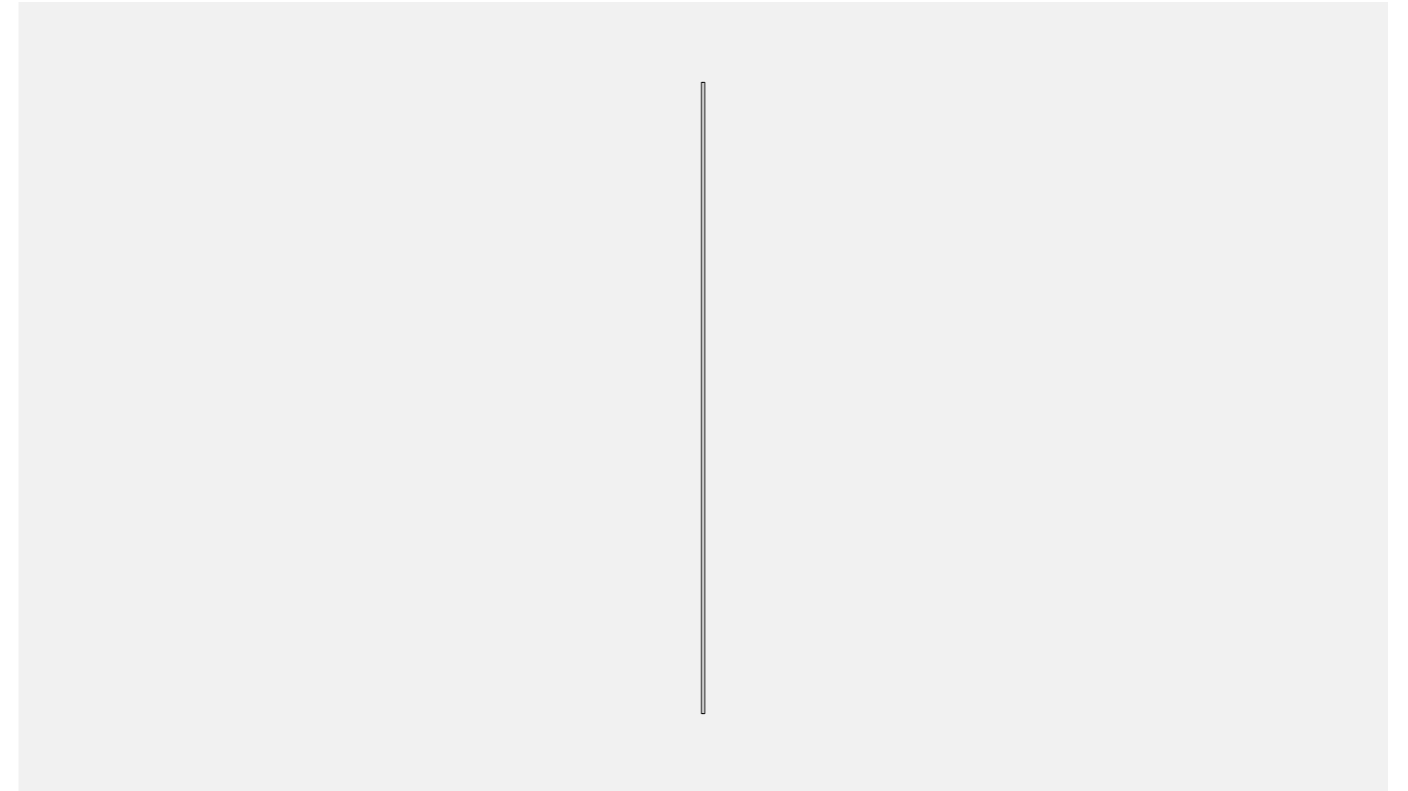

36" Built-In Fridge and 24" Built-In Wine Cellar Installation Kit.

CODE **REFSBSINT60**

Note: Handle kit: Distinto Fridge and Wine Cellar handles are to be supplied by installer.



FULGOR
MILANO

TECHNICAL DIMENSION

PROFESSIONAL

AND

DISTINTO

48" **NEW** DUAL FUEL CODE ID F6PDF486GS1

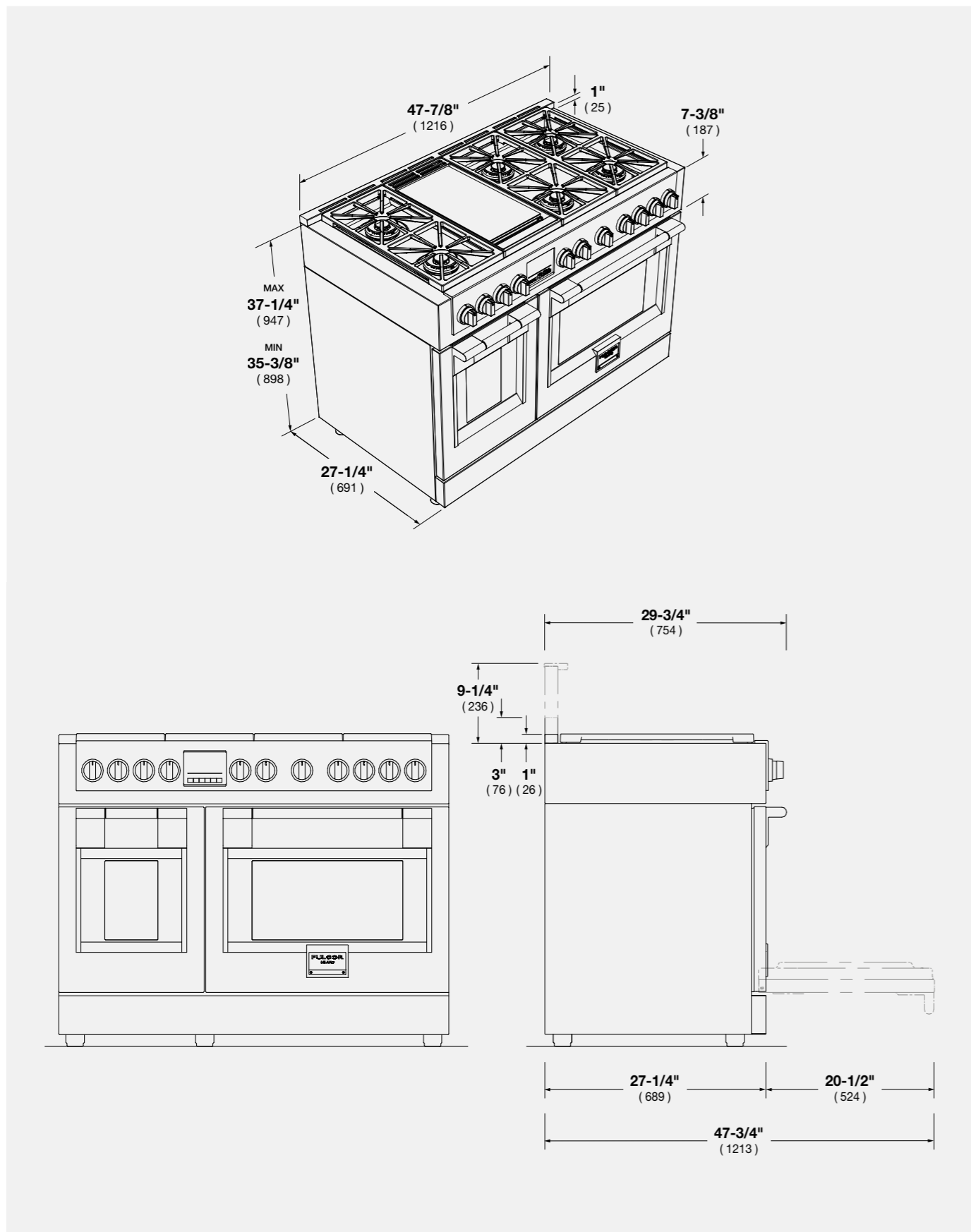

36" ALL GAS DUAL FUEL CODE ID F6PGR366S2
CODE ID F6PDF366S1

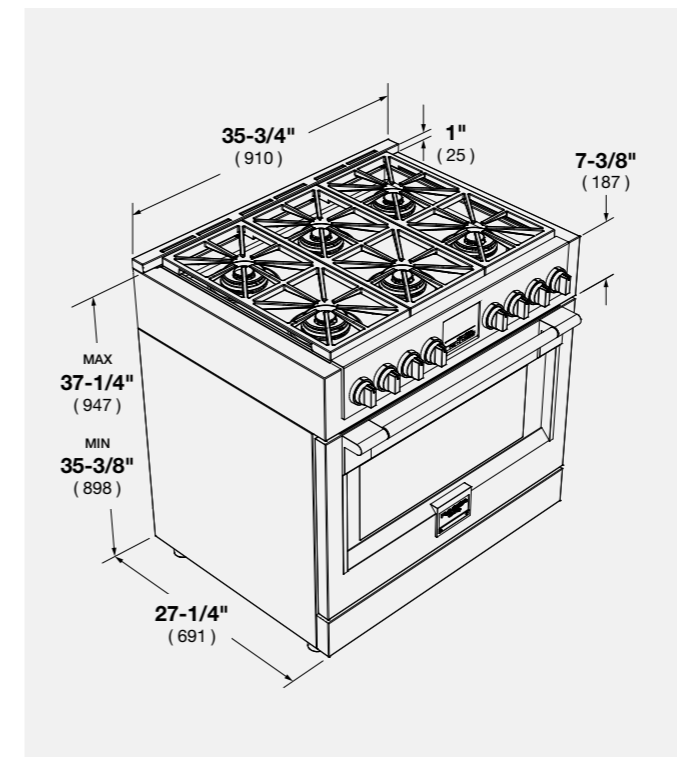

30" ALL GAS DUAL FUEL CODE ID F6PGR304S2
CODE ID F6PDF304S1

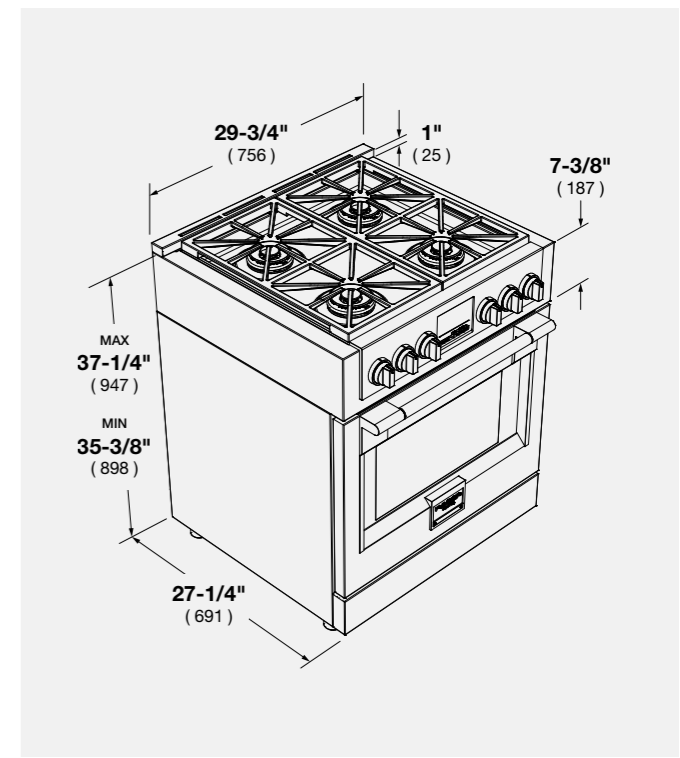

36" **NEW** INDUCTION CODE ID F6PIR365S1

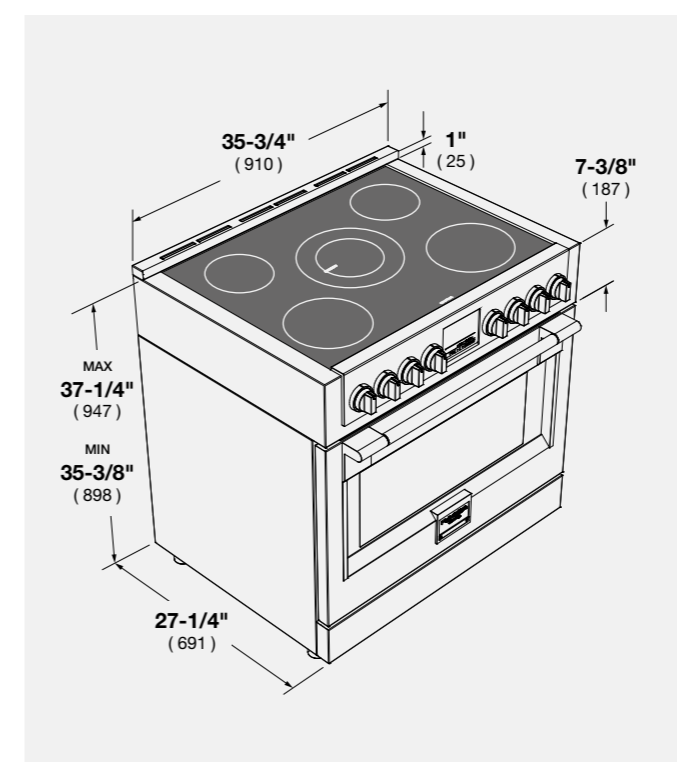

30" INDUCTION CODE ID F6PIR304S1

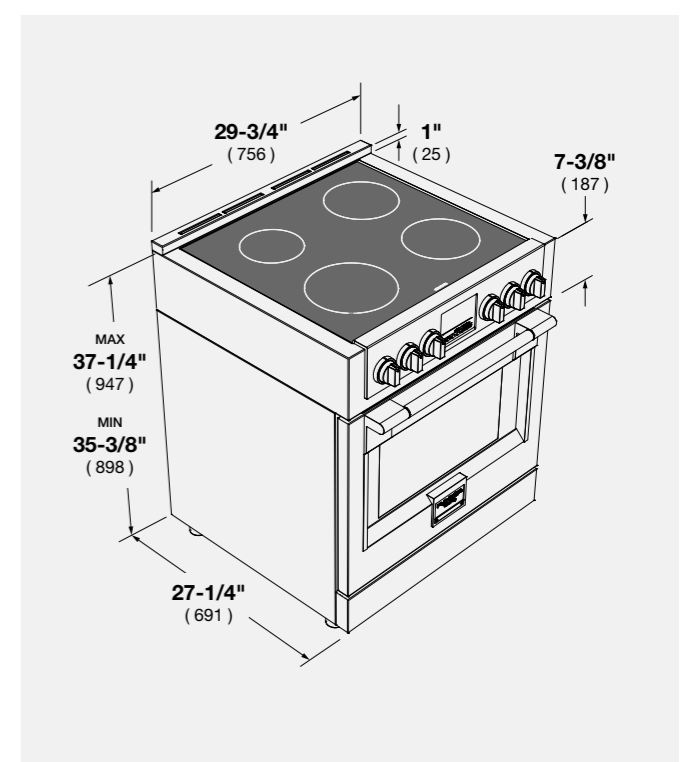

36" GAS TOP RANGE CODE ID F6GRT366S1

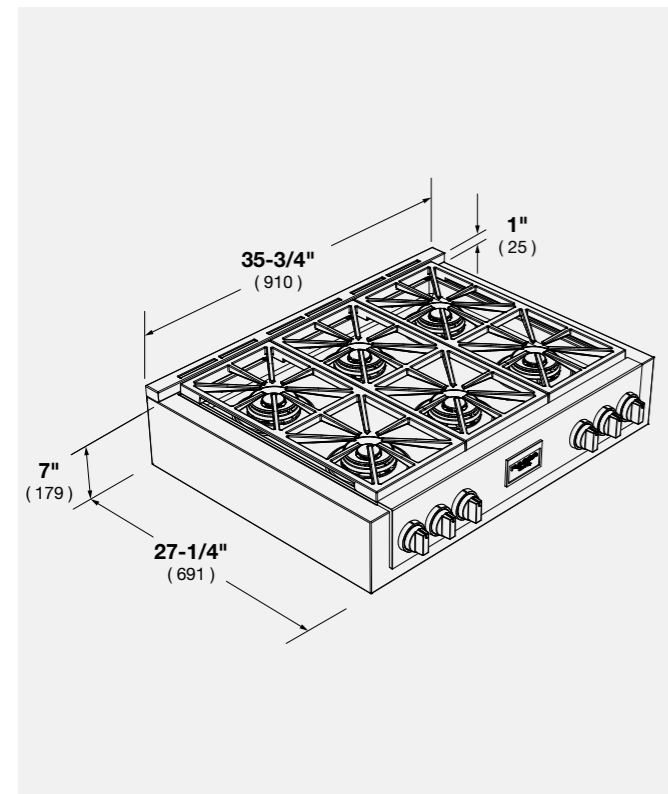

30" GAS TOP RANGE CODE ID F6GRT304S1

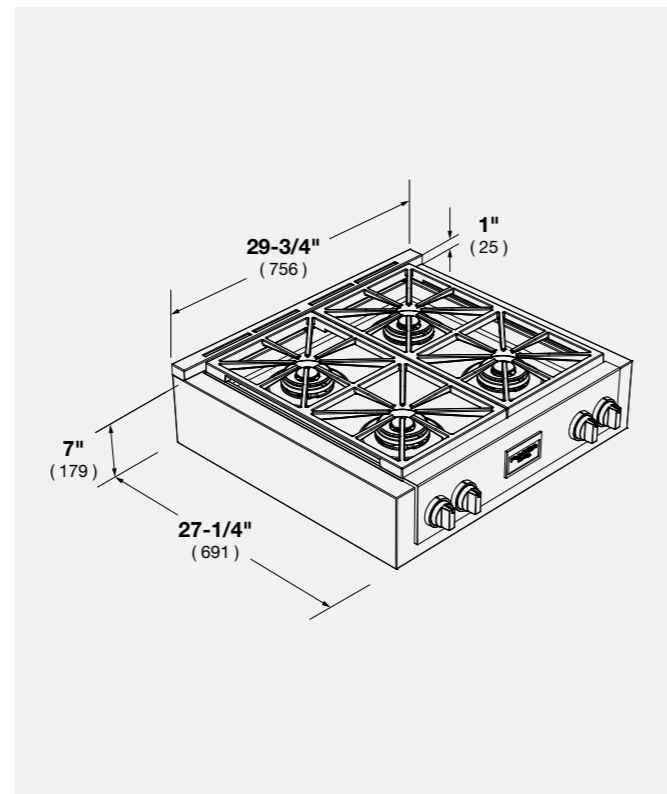

30" INDUCTION TOP RANGE CODE ID F6IRT304S1

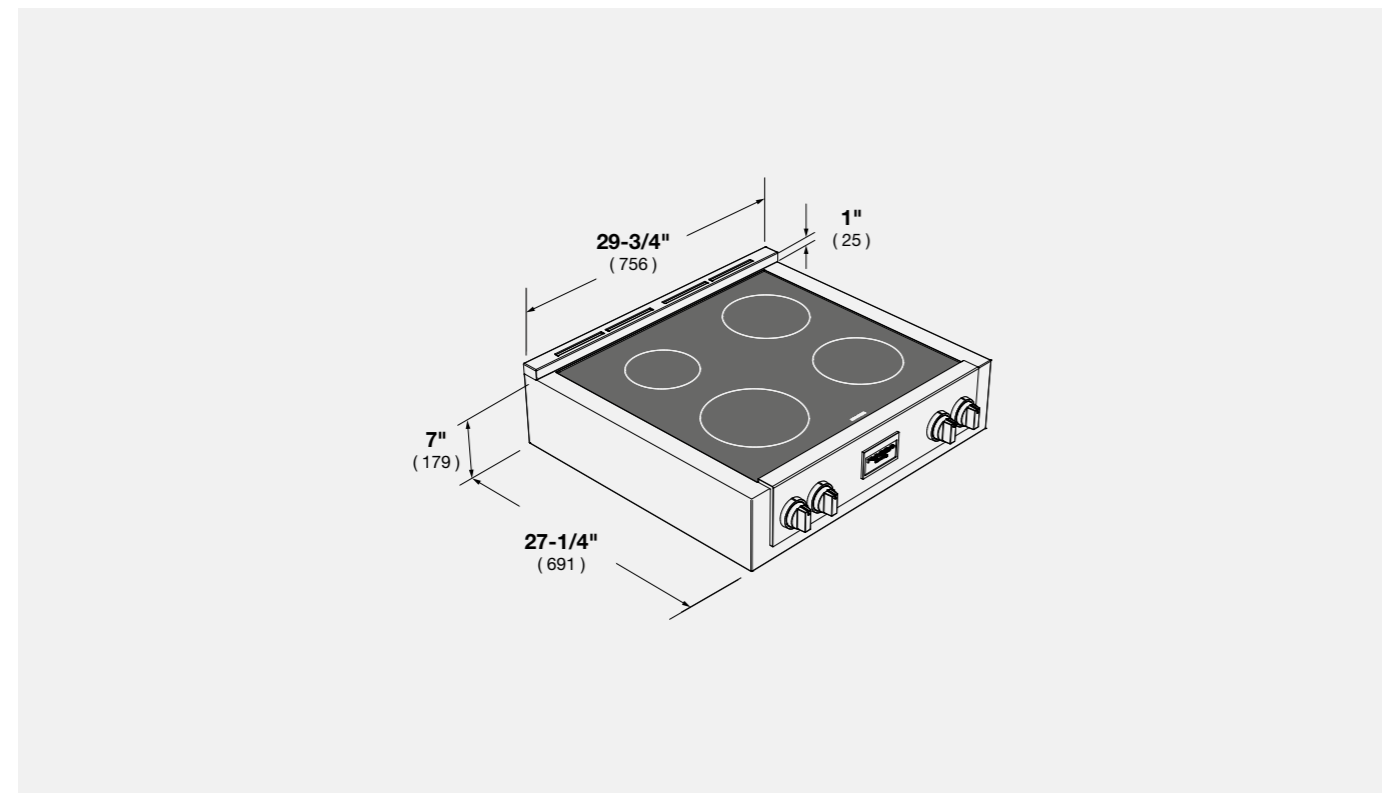

36" PRO GAS COOK TOP CODE ID F6PGK365S1

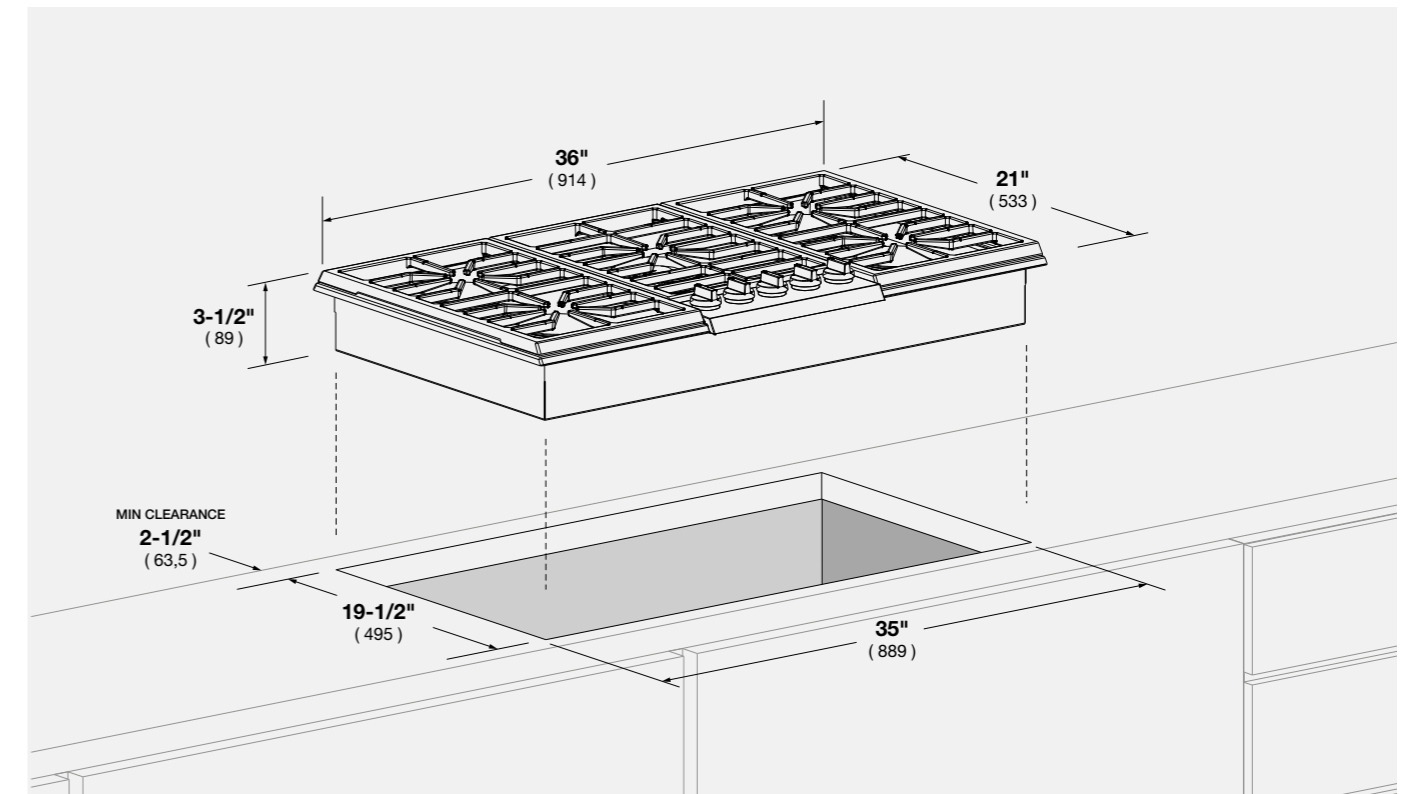

30" PRO GAS COOK TOP CODE ID F6PGK305S1

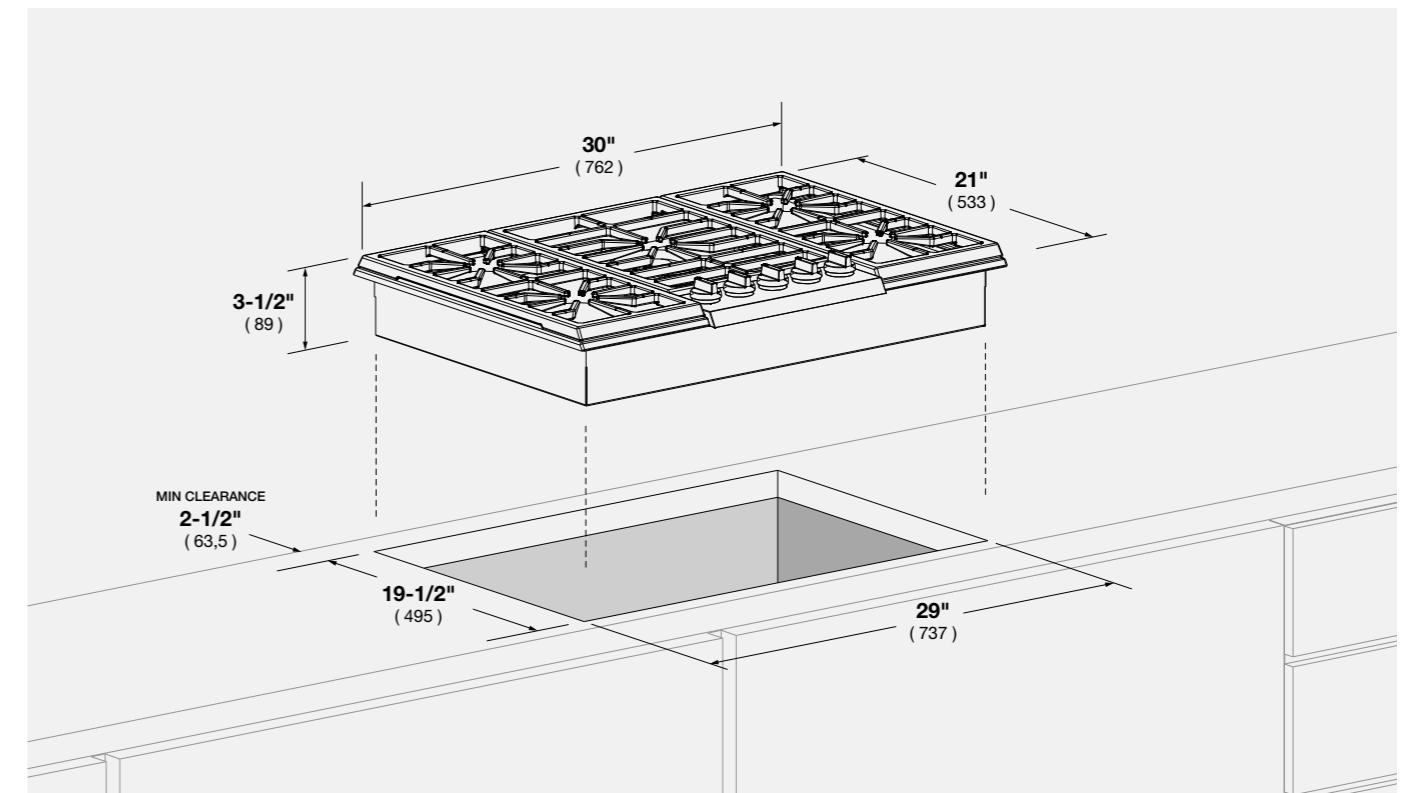

30" DOUBLE OVEN CODE ID F6PDP30S1

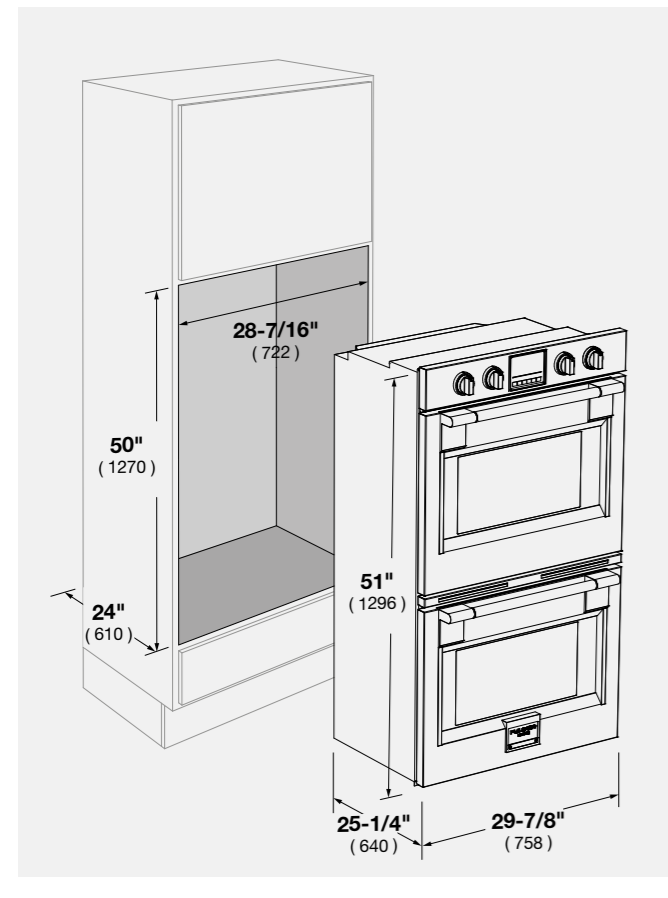

30" SINGLE OVEN CODE ID F6PSP30S1

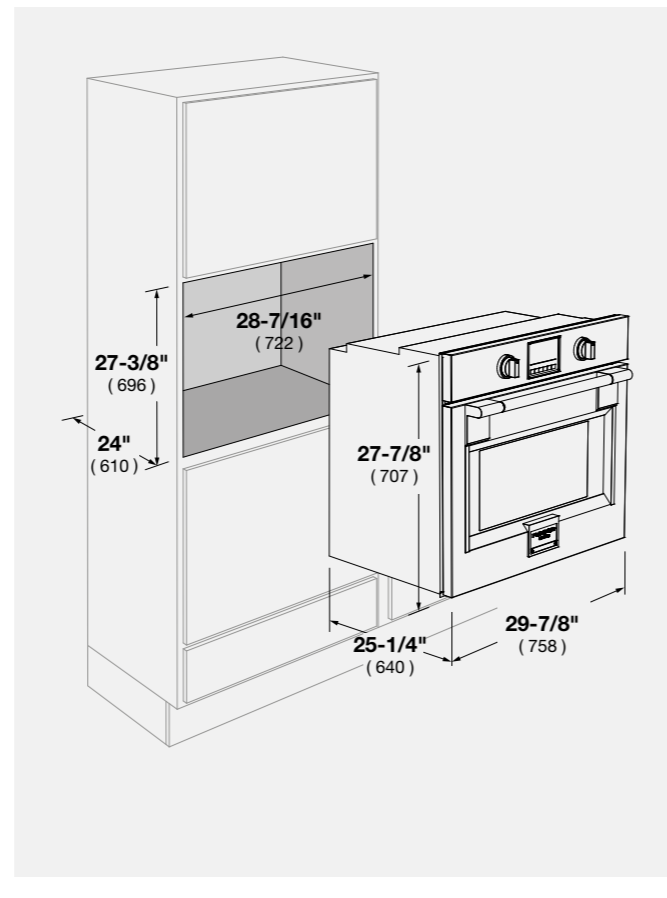

30" NEW WARMING DRAWER CODE ID F6PWD30S1

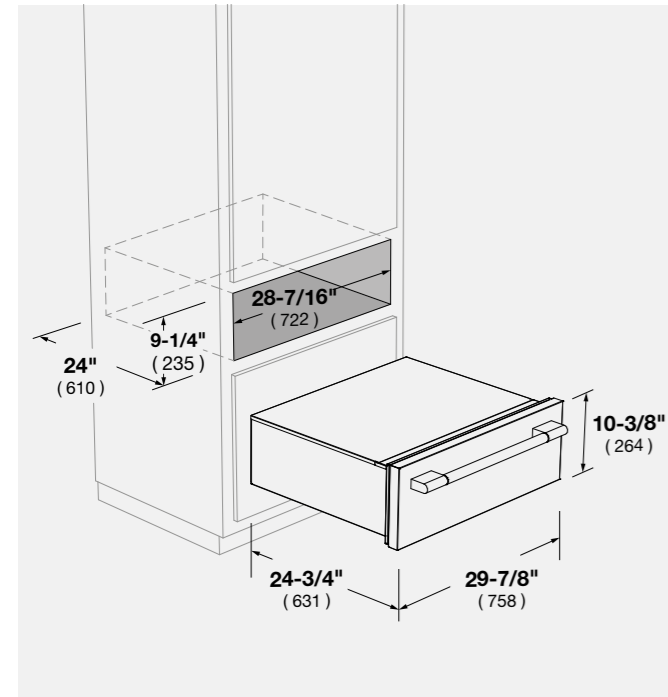

24" DISHWASHER CODE ID F6PDW24SS1

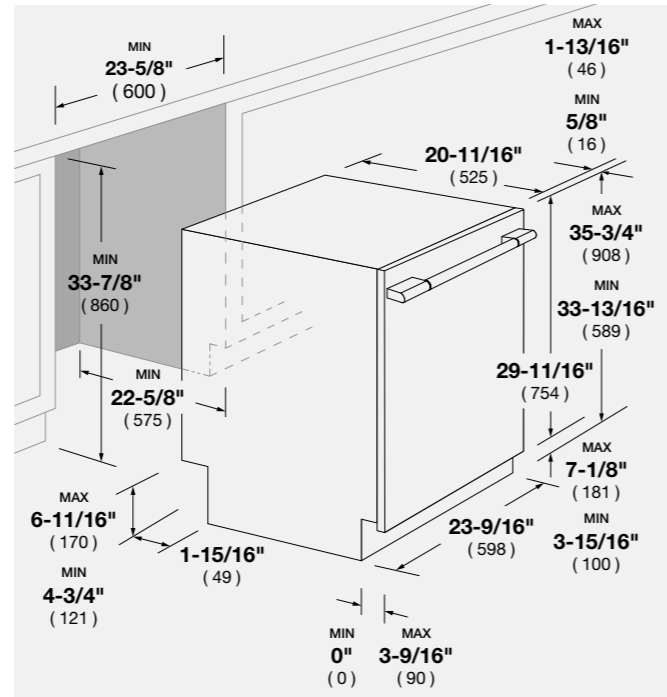

48" NEW HOOD CODE ID F6PH48DS1

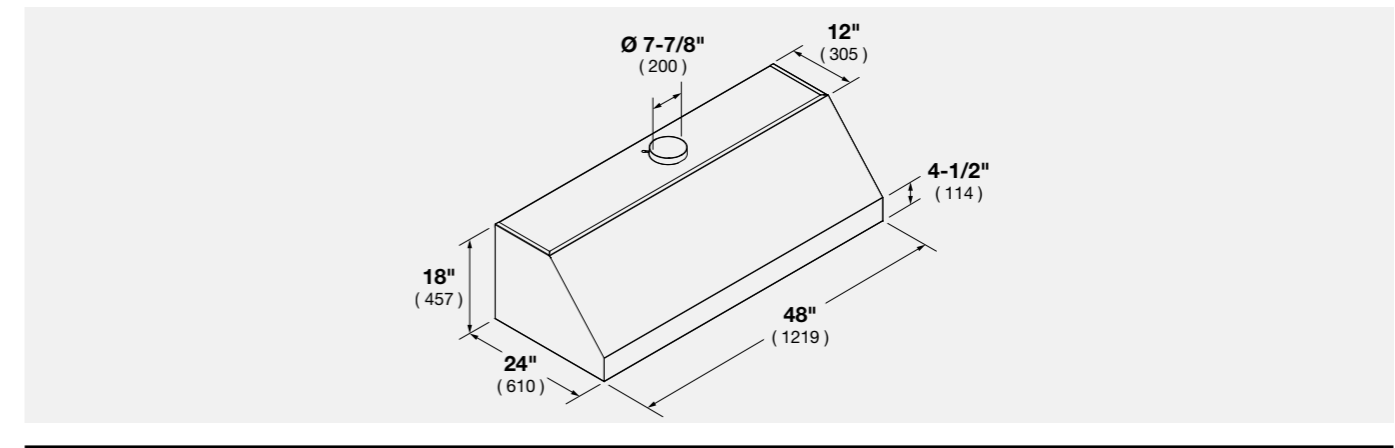

36" NEW HOOD CODE ID F6PH36DS1

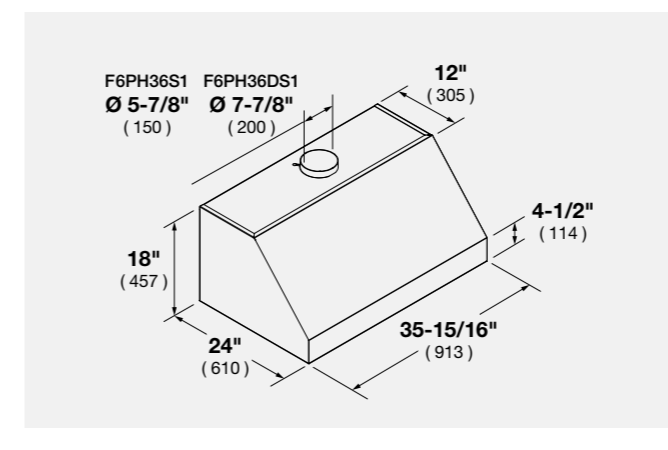

30" NEW HOOD CODE ID F6PH30S2

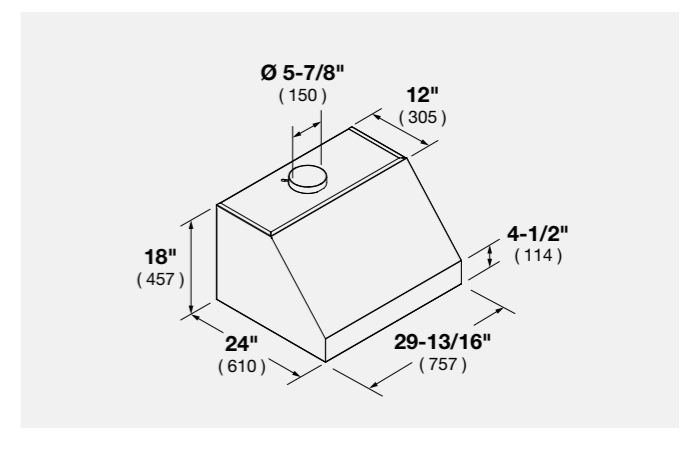

46" NEW INSERT HOOD CODE ID F6BP46DS1

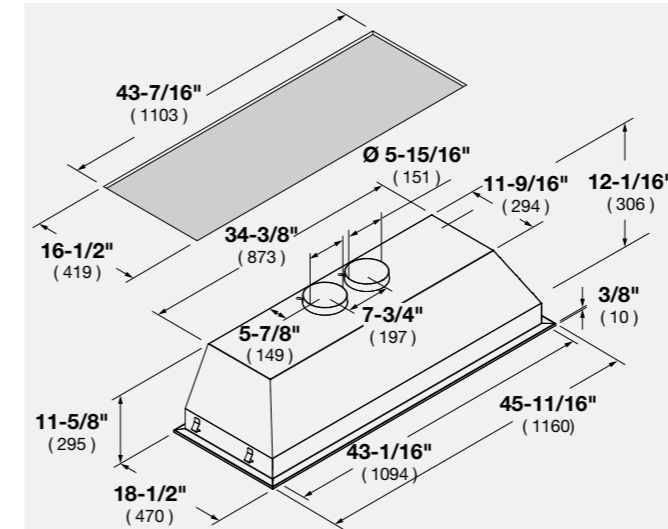

34" NEW INSERT HOOD CODE ID F6BP34DS1

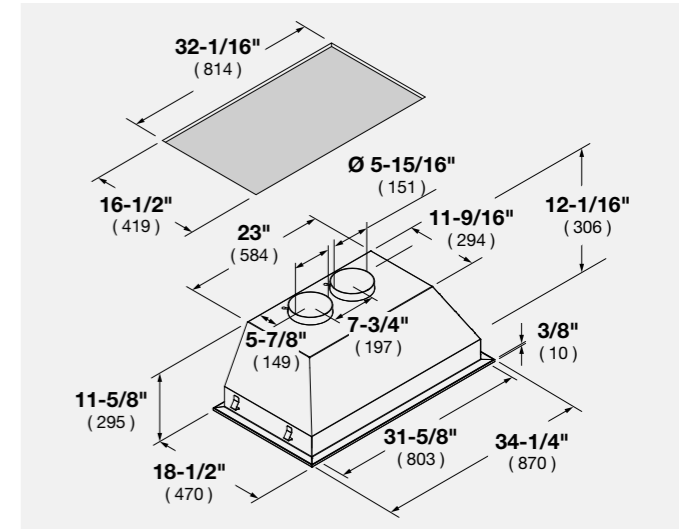

36" **NEW** FRIDGE LEFT DOOR
FRIDGE RIGHT DOOR

CODE ID F7PBM36S1-L
CODE ID F7PBM36S1-R

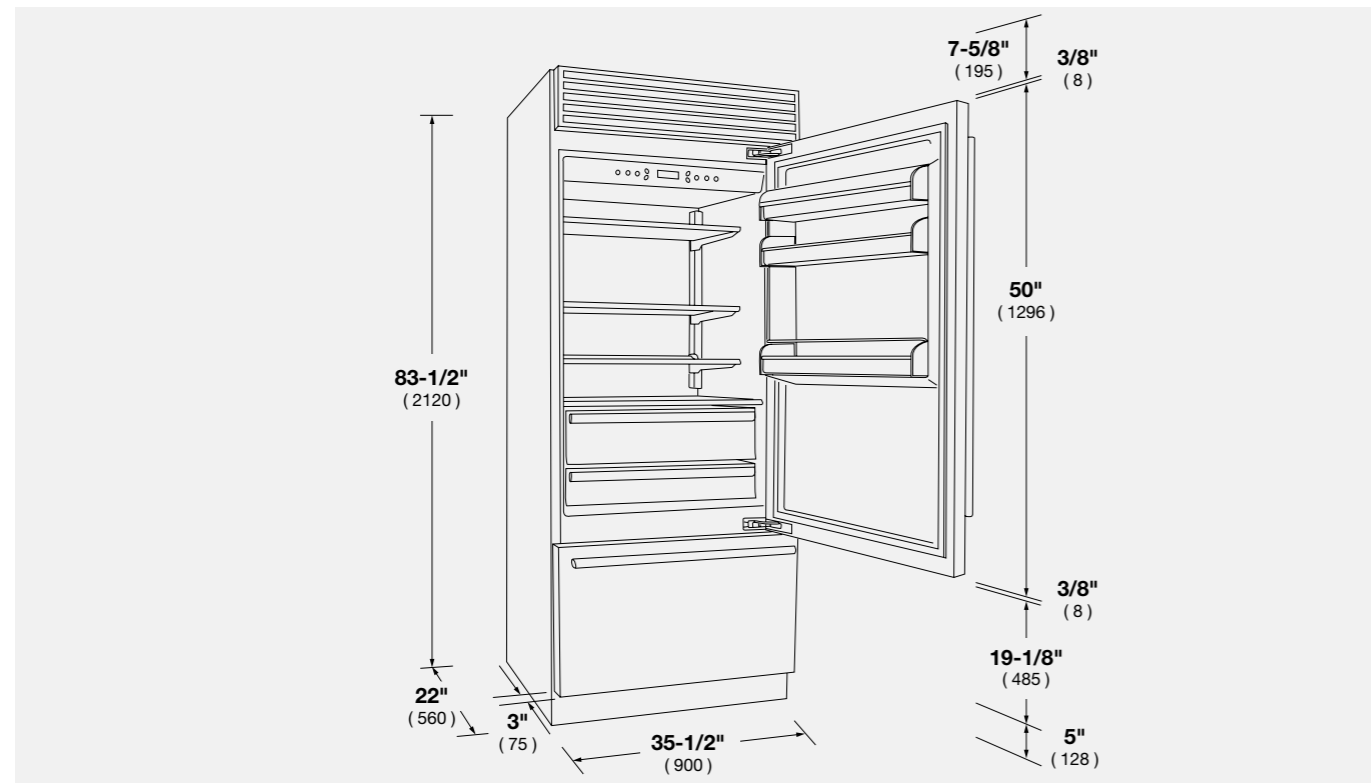

36" **NEW** BUILT-IN FRIDGE LEFT DOOR
BUILT-IN FRIDGE RIGHT DOOR

CODE ID F7IBM36O1-L
CODE ID F7IBM36O1-R

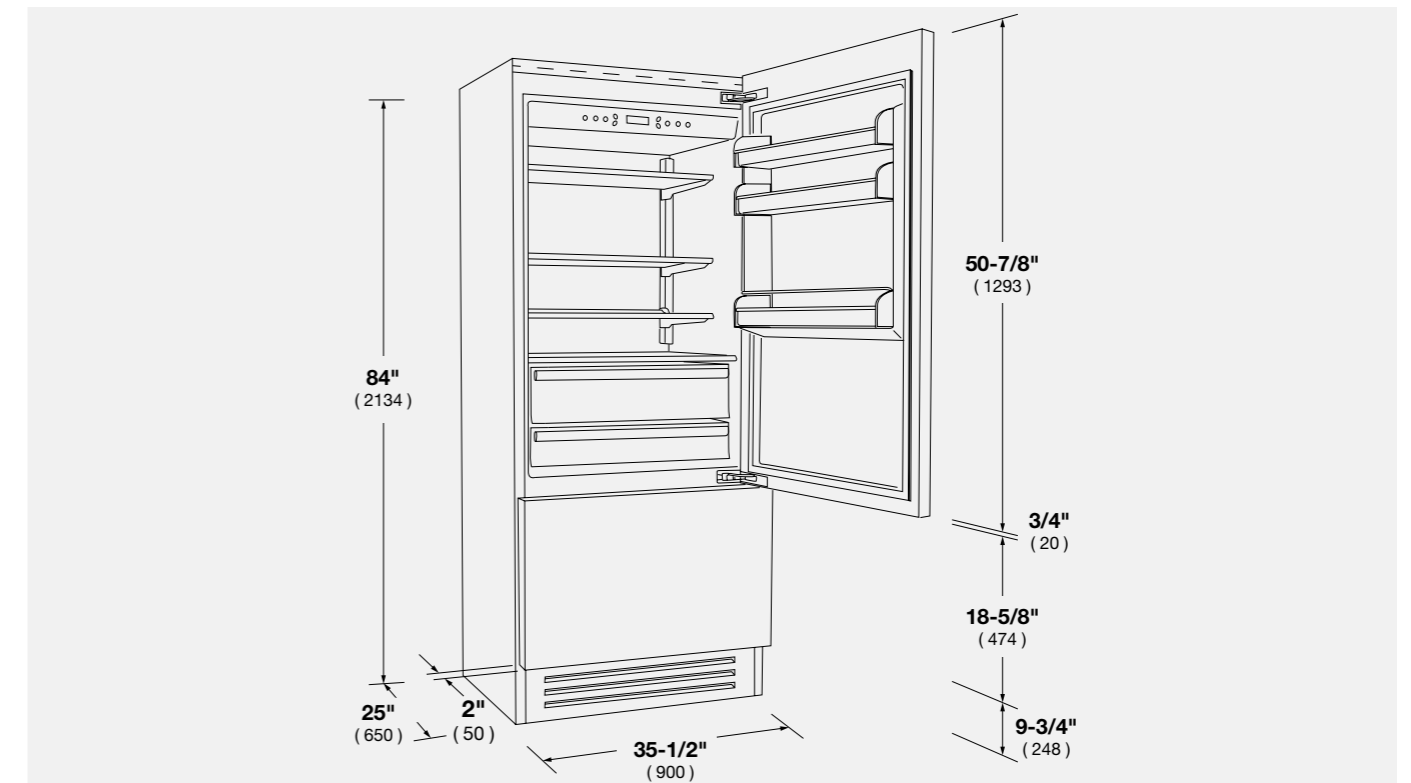

24" **NEW** WINE CELLAR LEFT DOOR
WINE CELLAR RIGHT DOOR

CODE ID F7PBW24S1-L
CODE ID F7PBW24S1-R

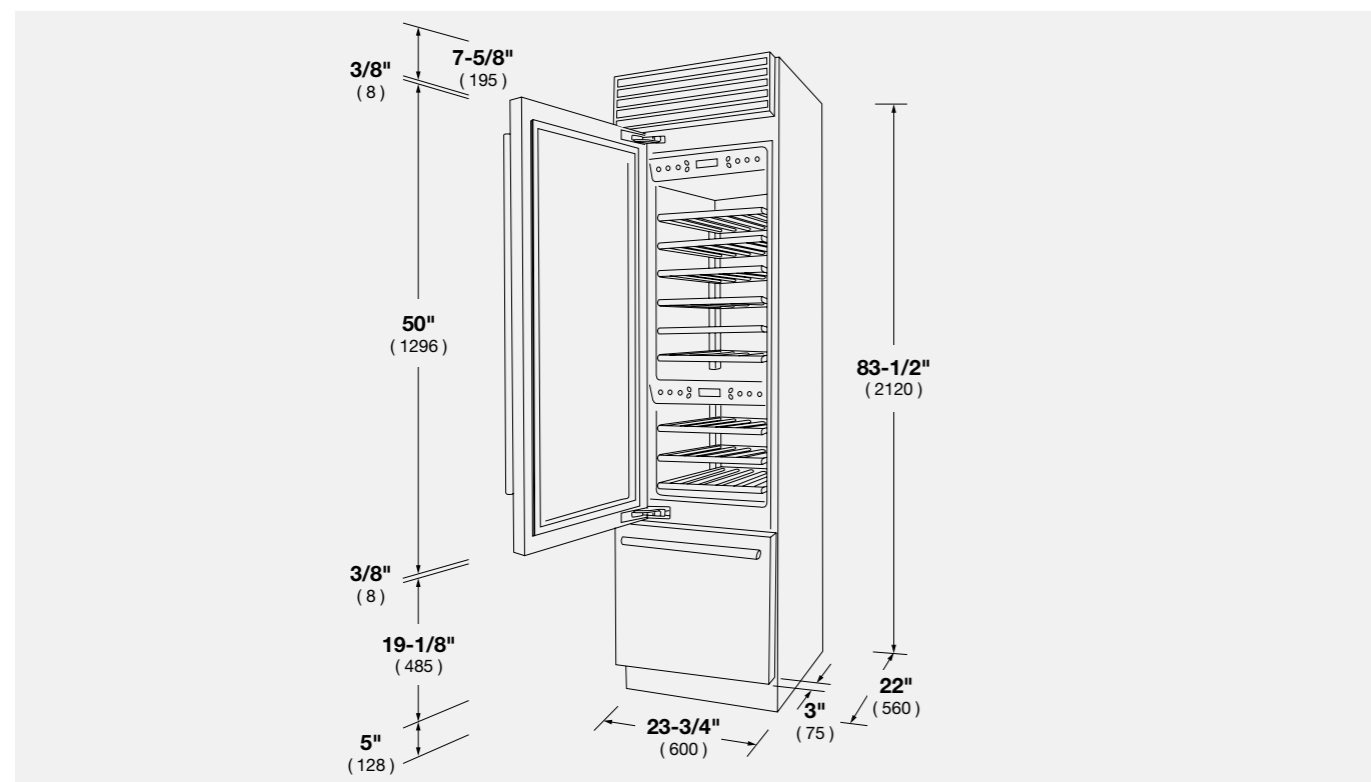

24" **NEW** BUILT-IN WINE CELLAR LEFT DOOR
BUILT-IN WINE CELLAR RIGHT DOOR

CODE ID F7IBW24O1-L
CODE ID F7IBW24O1-R

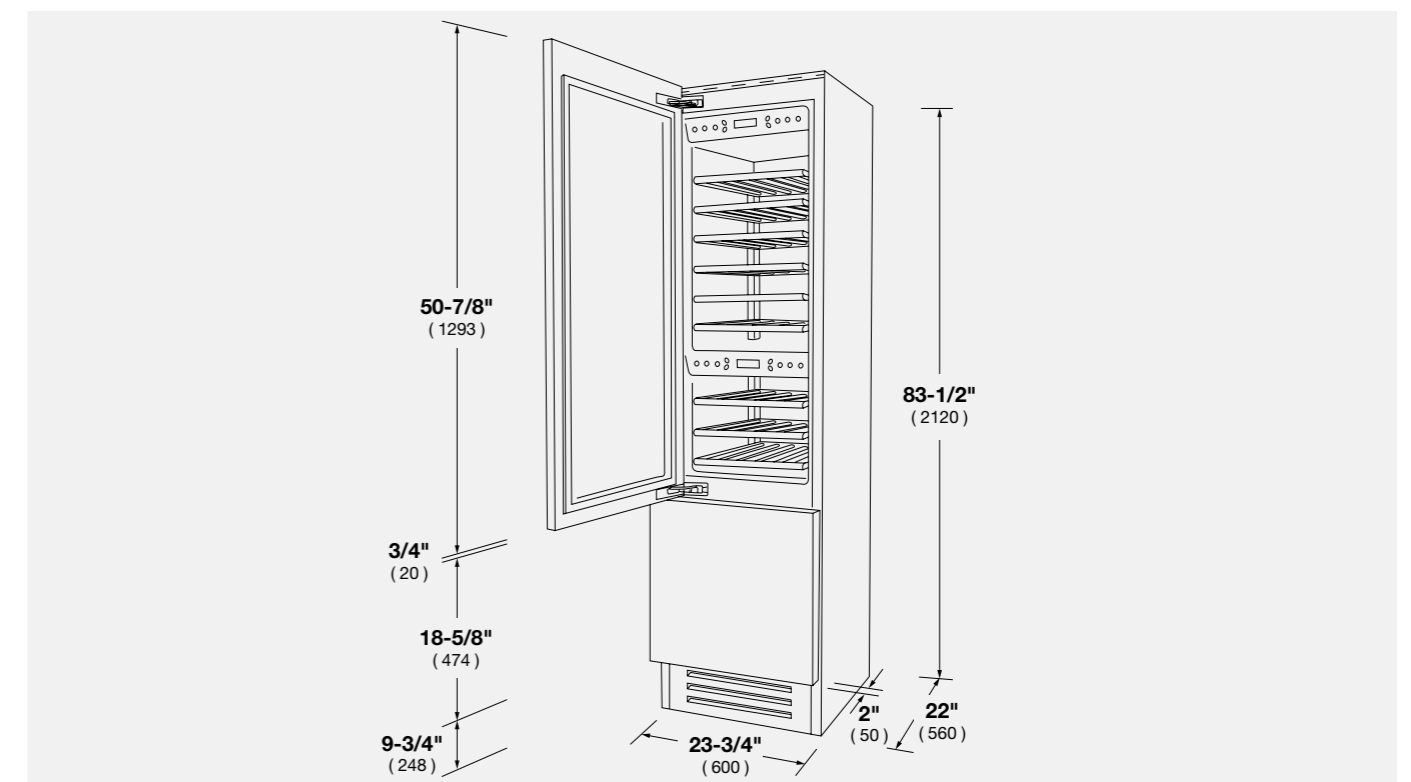

30"	DOUBLE OVEN	CODE ID	F7DP30S1
	DOUBLE OVEN	CODE ID	F7DP30B1
	DOUBLE OVEN	CODE ID	F7DP30W1

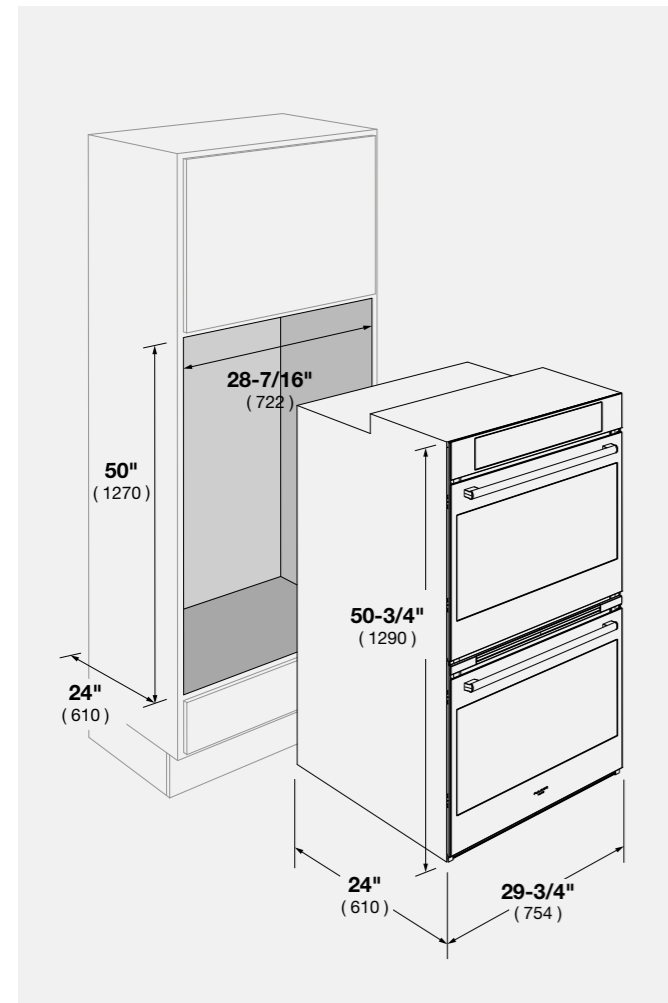

30"	SINGLE OVEN	CODE ID	F7SP30S1
	SINGLE OVEN	CODE ID	F7SP30B1
	SINGLE OVEN	CODE ID	F7SP30W1
	SINGLE OVEN	CODE ID	F4SP30S1

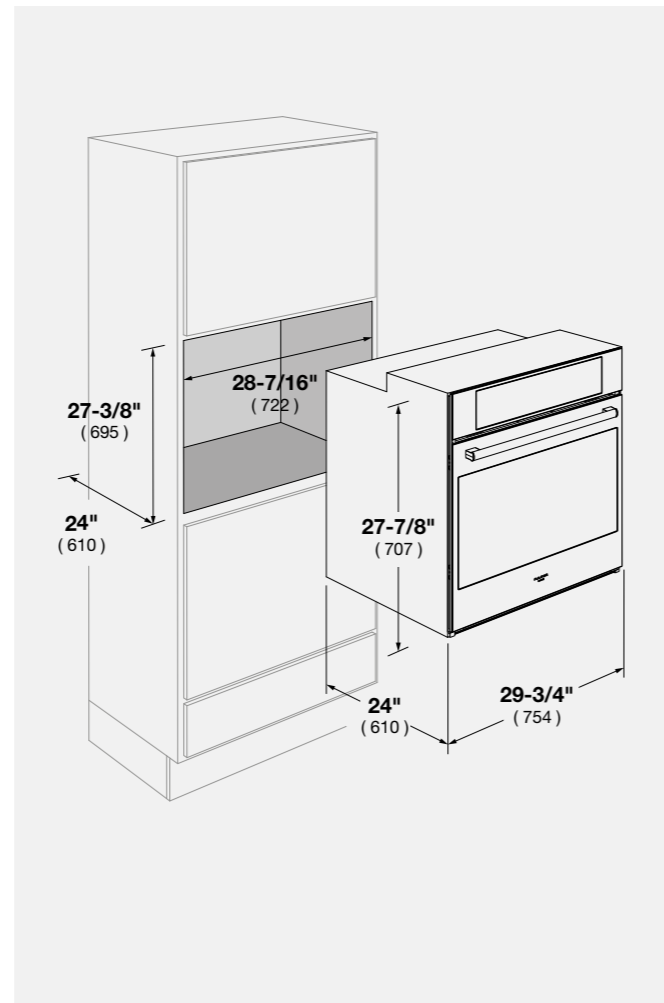

30"	SINGLE OVEN HIGH 24"	CODE ID	F1SP30S1
	SINGLE OVEN HIGH 24"	CODE ID	F1SM30S1

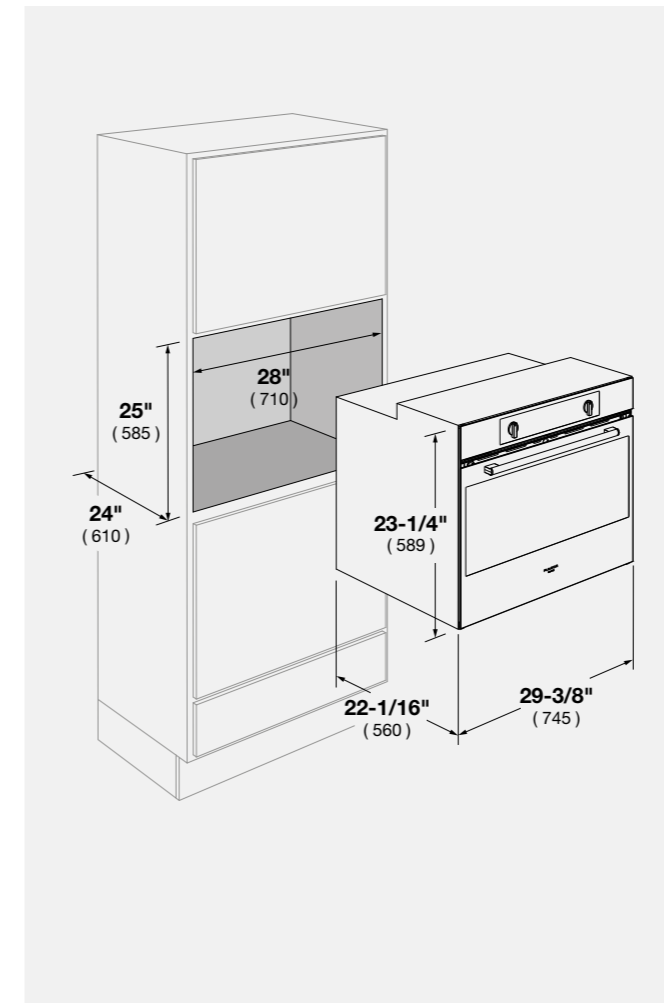

24"	SINGLE OVEN	CODE ID	F1SP24S2
	SINGLE OVEN	CODE ID	F1SM24S2

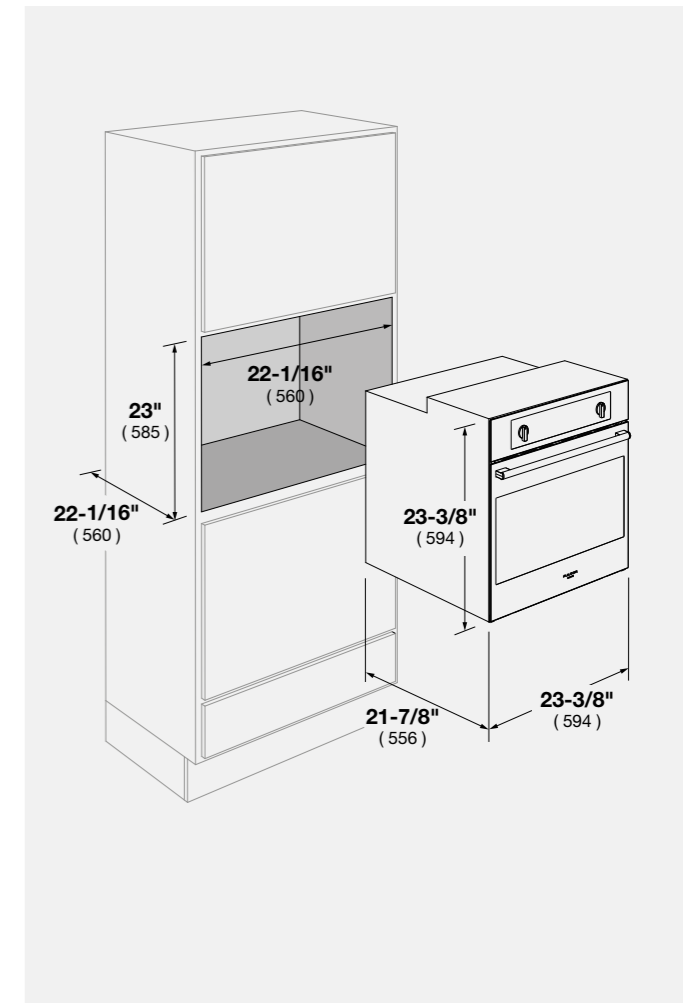

30"	NEW	WARMING DRAWER PUSH PULL INOX	CODE ID	F7DWD30S1
------------	------------	----------------------------------	---------	-----------

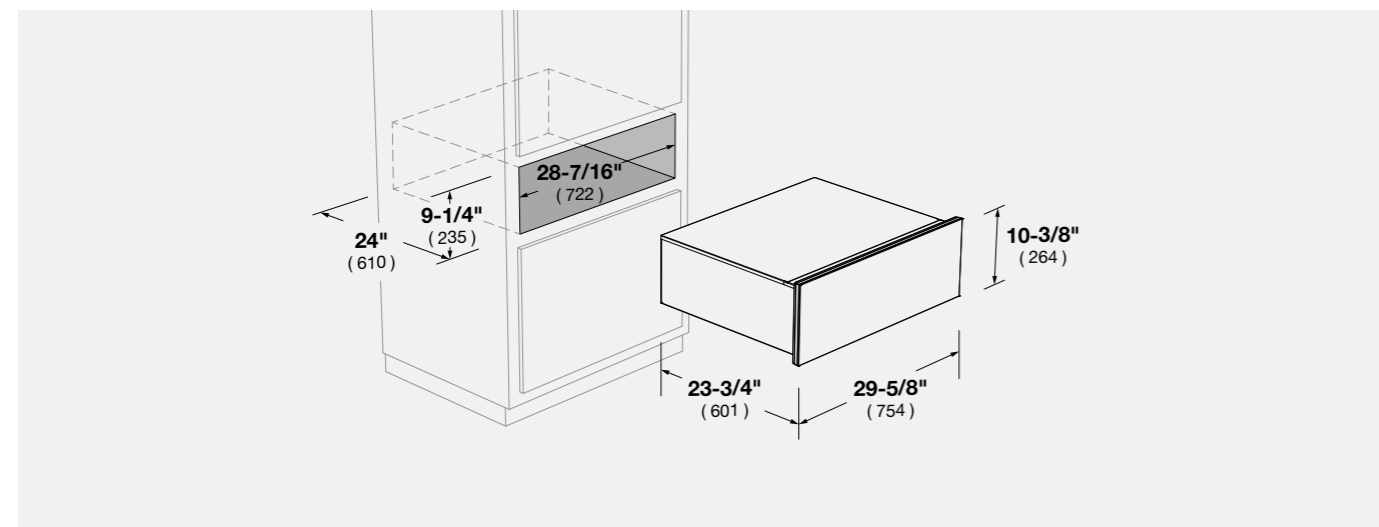

30"	NEW	WARMING DRAWER PUSH PULL OVERLAY PANEL	CODE ID	F71WD3001
------------	------------	---	---------	-----------

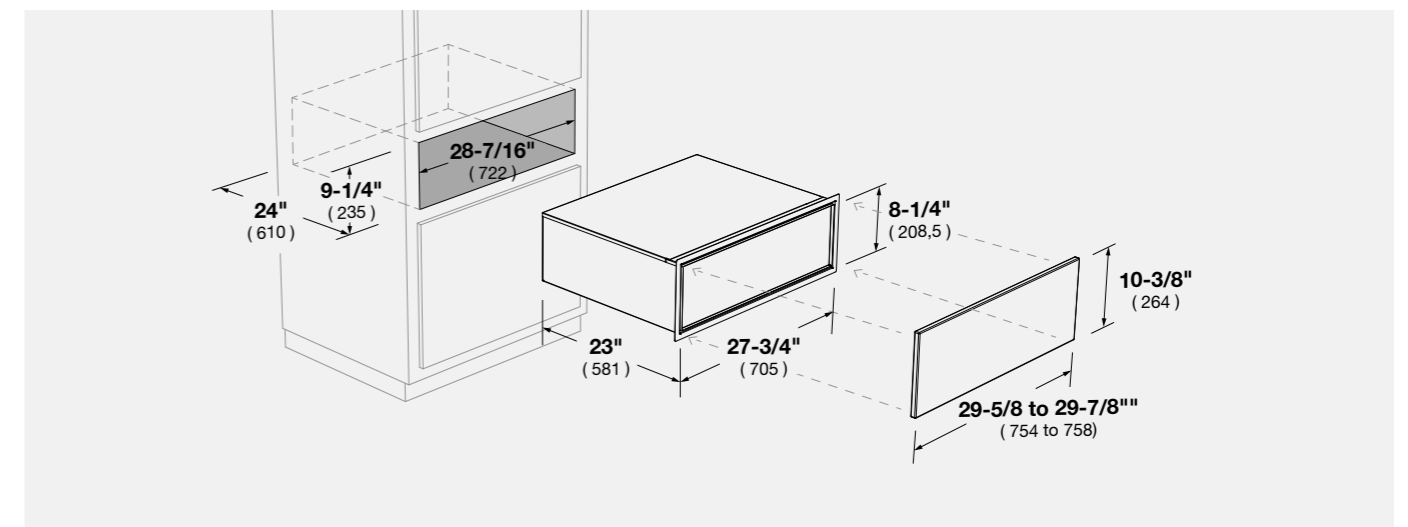

44" COOKTOP GAS CODE ID **F4GK42S1**

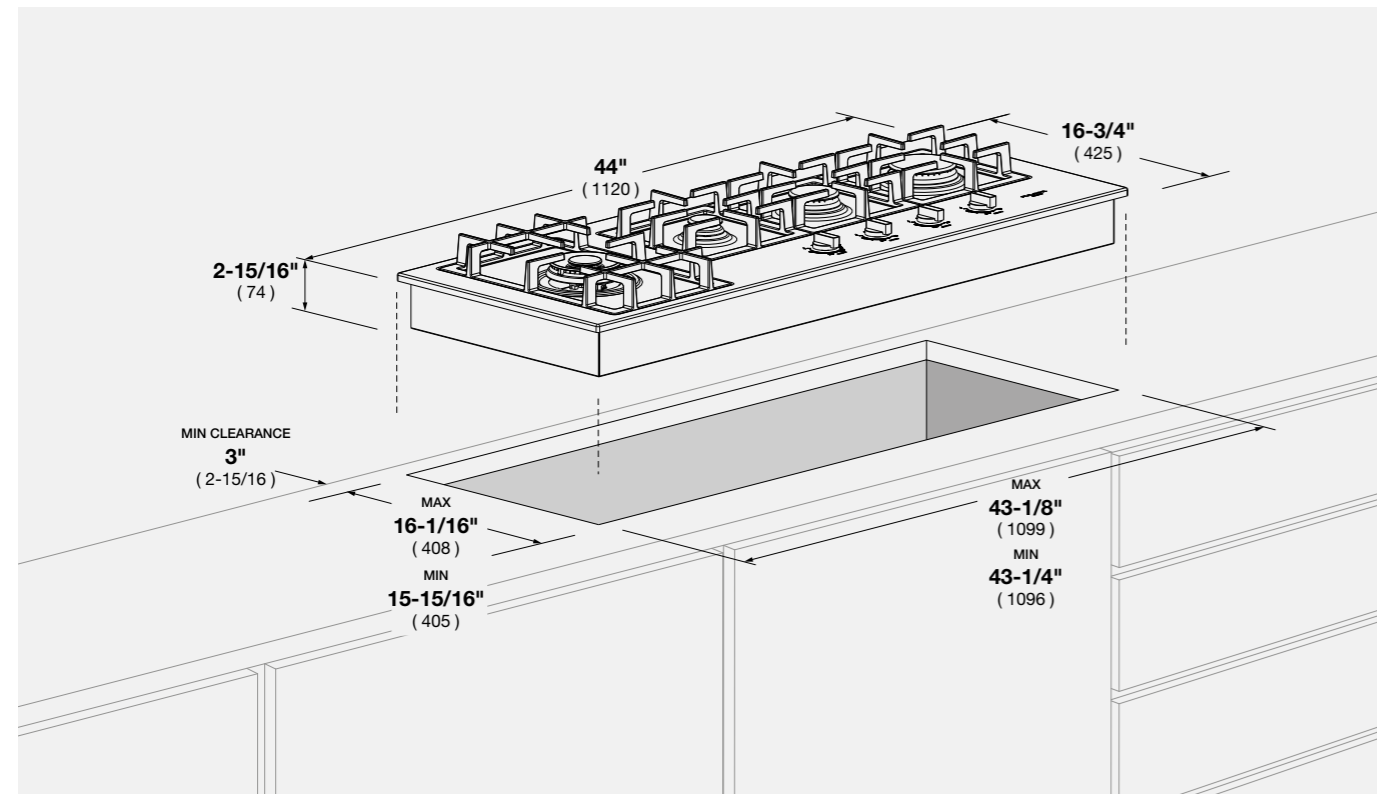

30" COOKTOP GAS CODE ID **F4GK30S1**

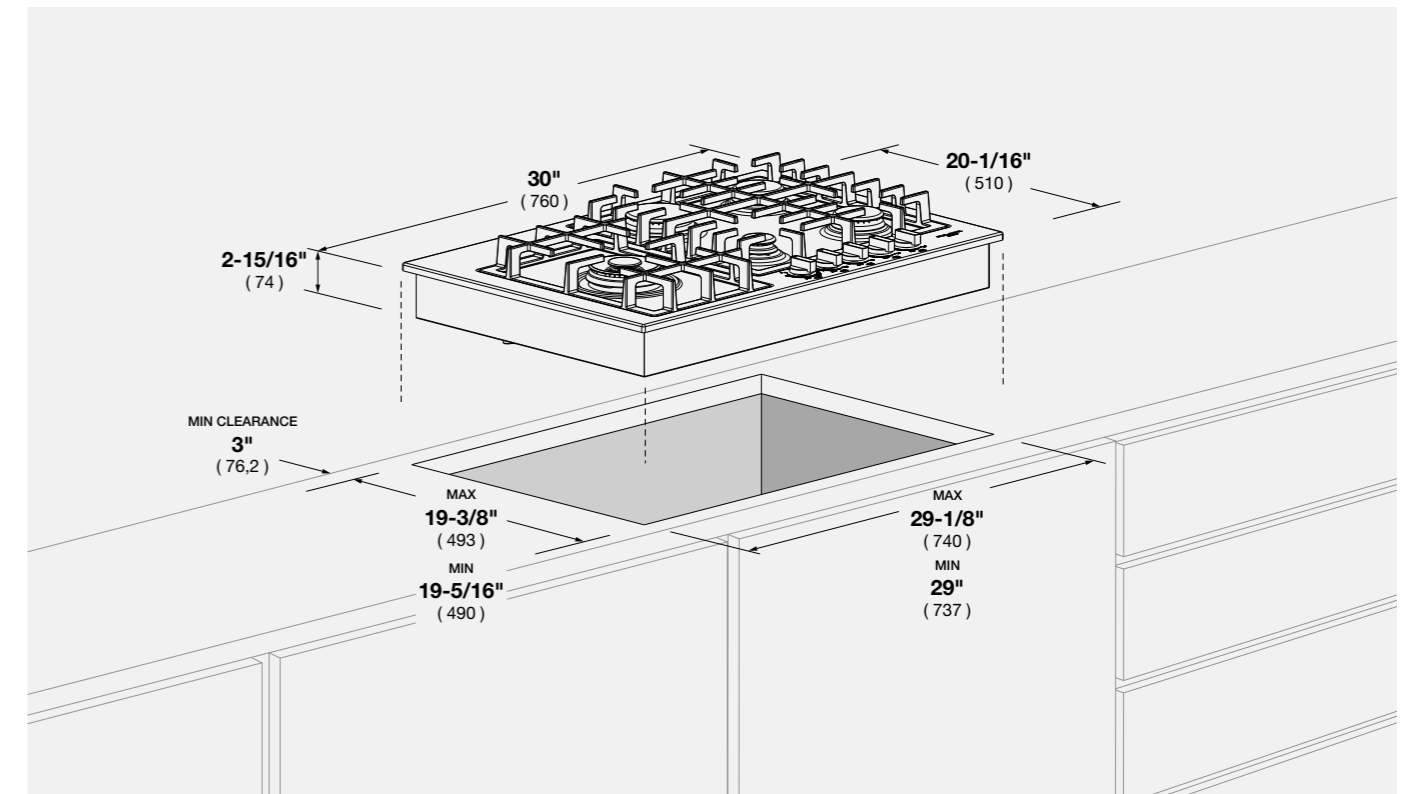

36" COOKTOP GAS CODE ID **F4GK36S1**

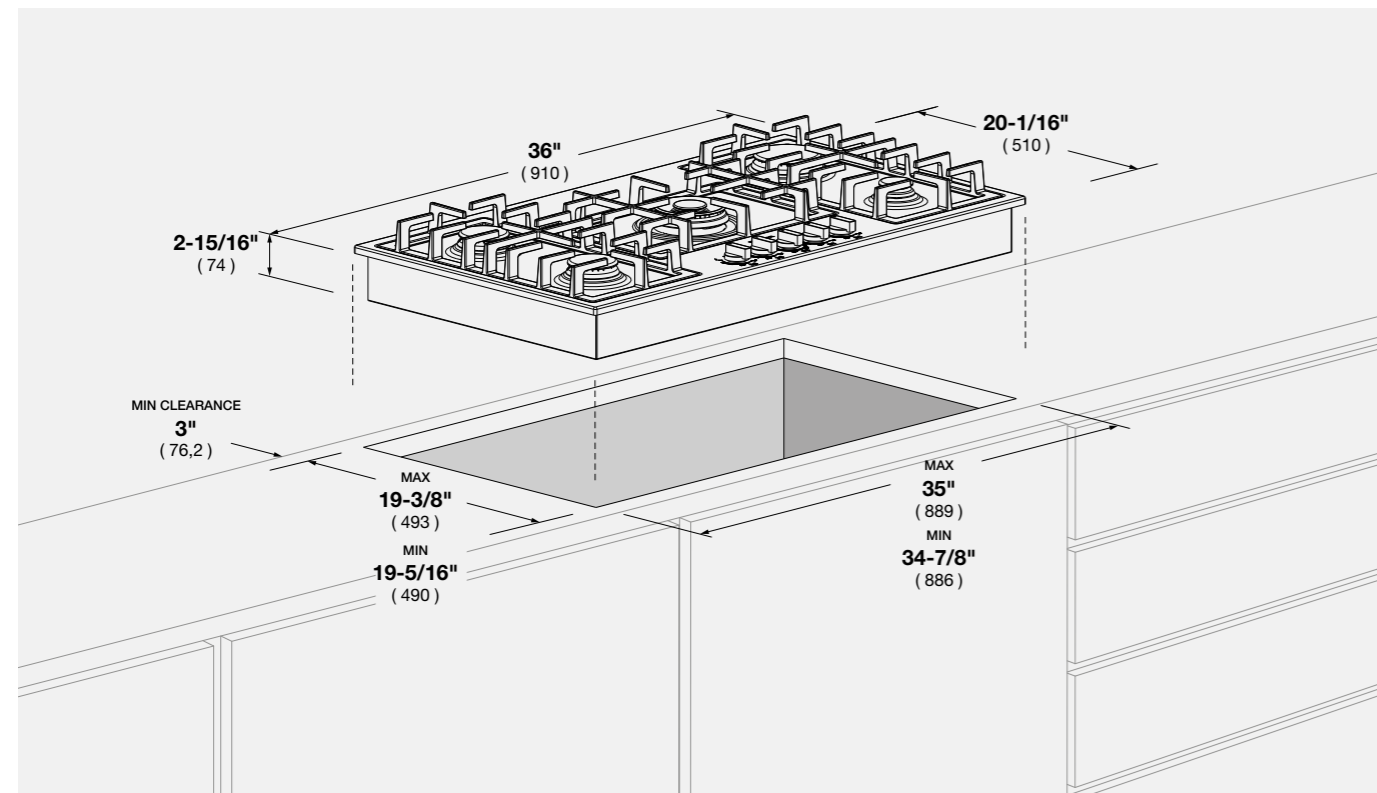

24" COOKTOP GAS CODE ID **F4GK24S1**

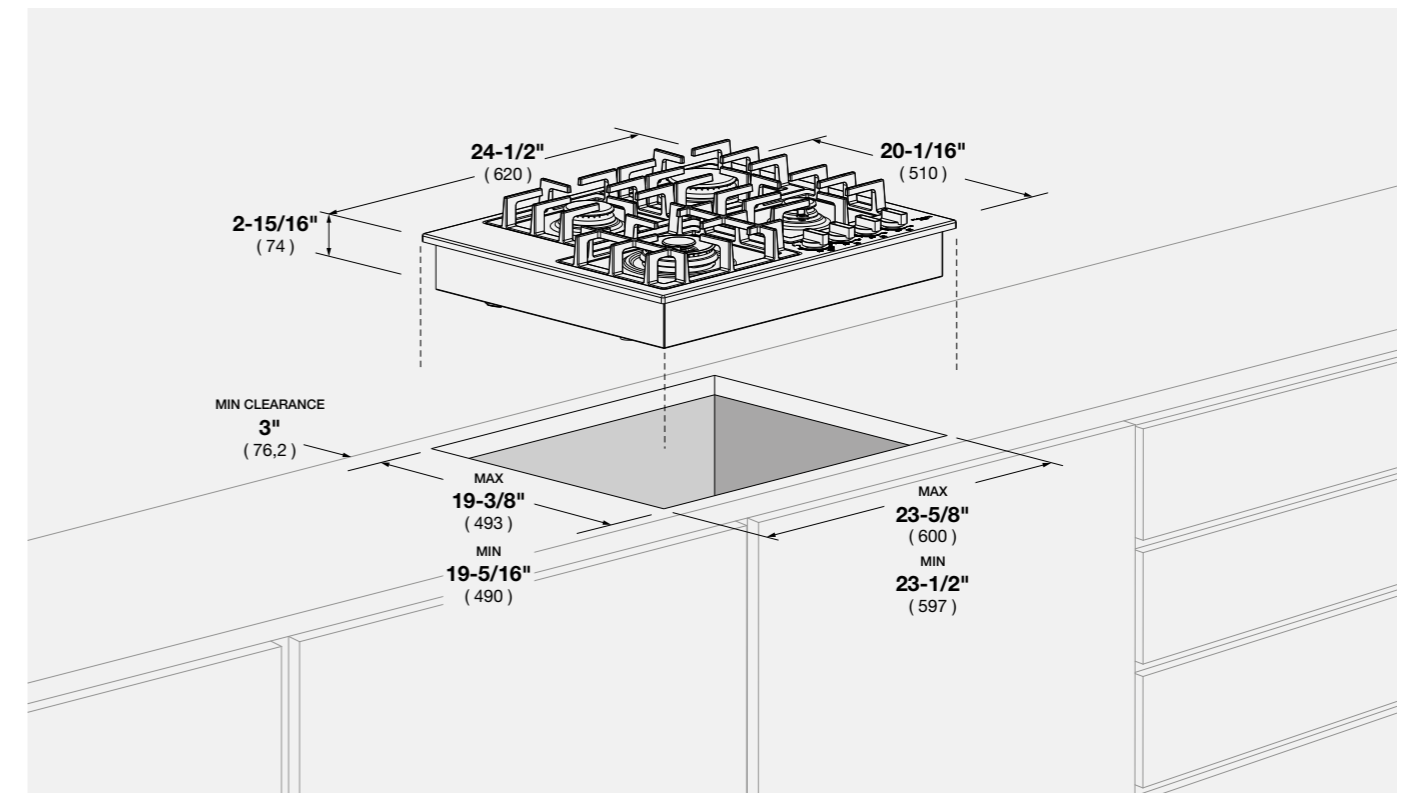

36" INDUCTION CODE ID **F7IT36S1**

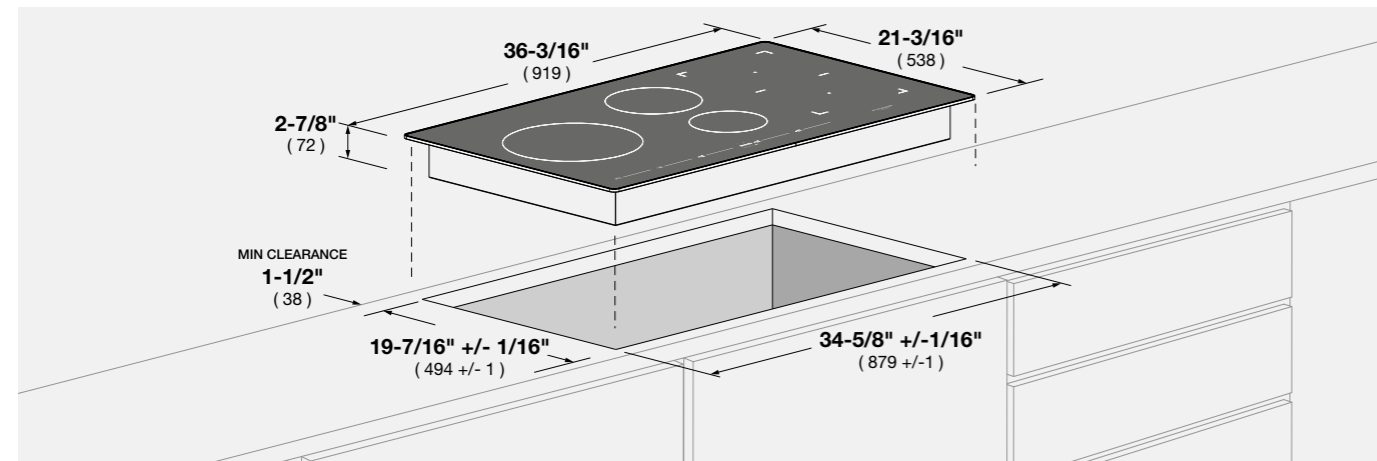

30" INDUCTION CODE ID **F7IT30S1**

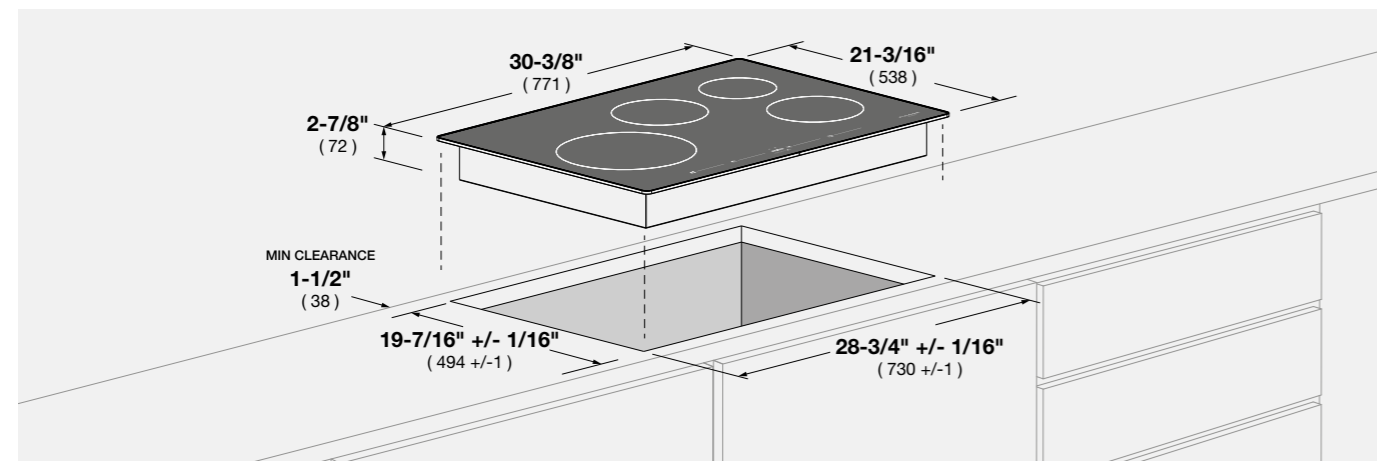

36" RADIANT CODE ID **F6RT36S2**

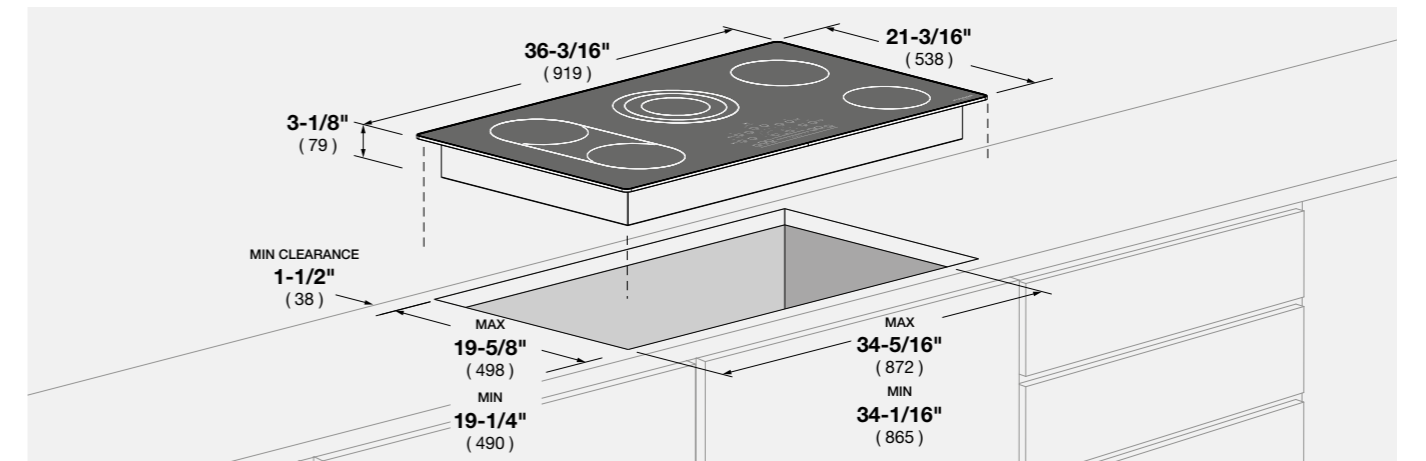

30" RADIANT CODE ID **F6RT30S2**

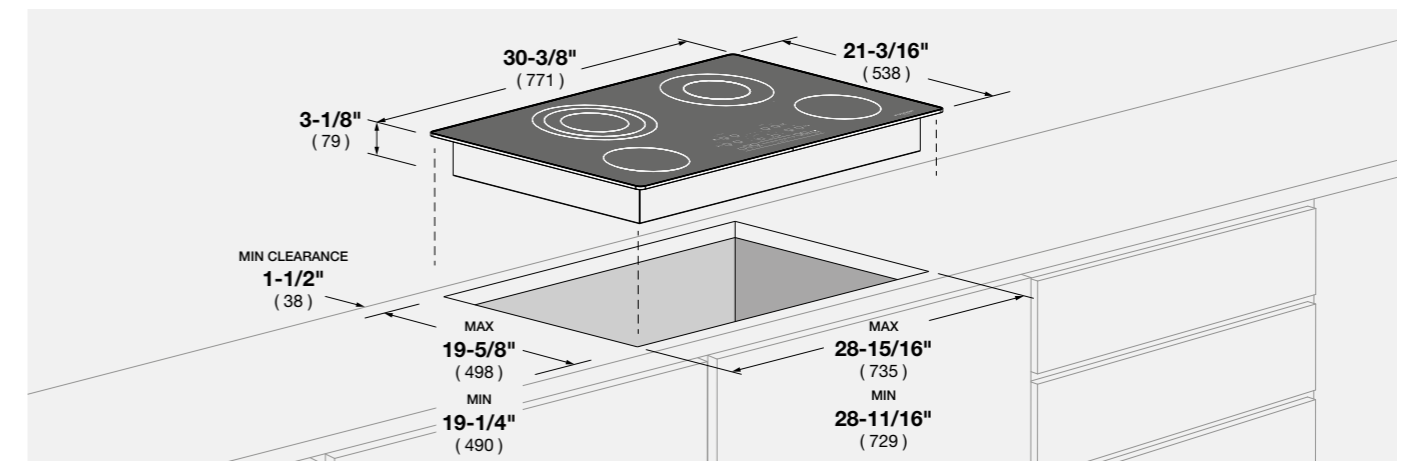

24" RADIANT CODE ID **F3RK24S2**

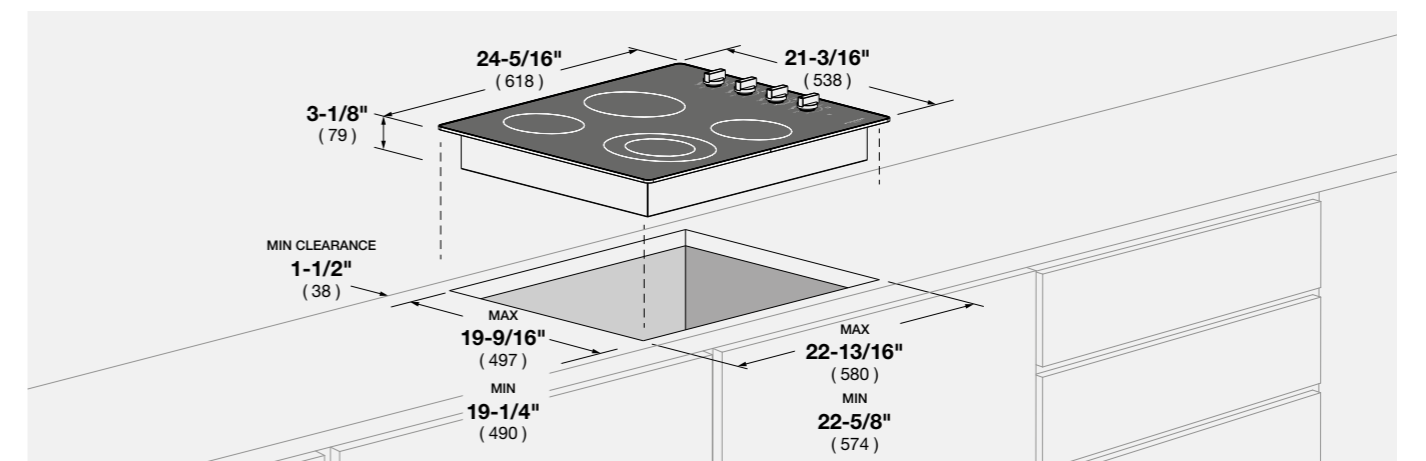

34" INSERT HOOD CODE ID F6BP34S1

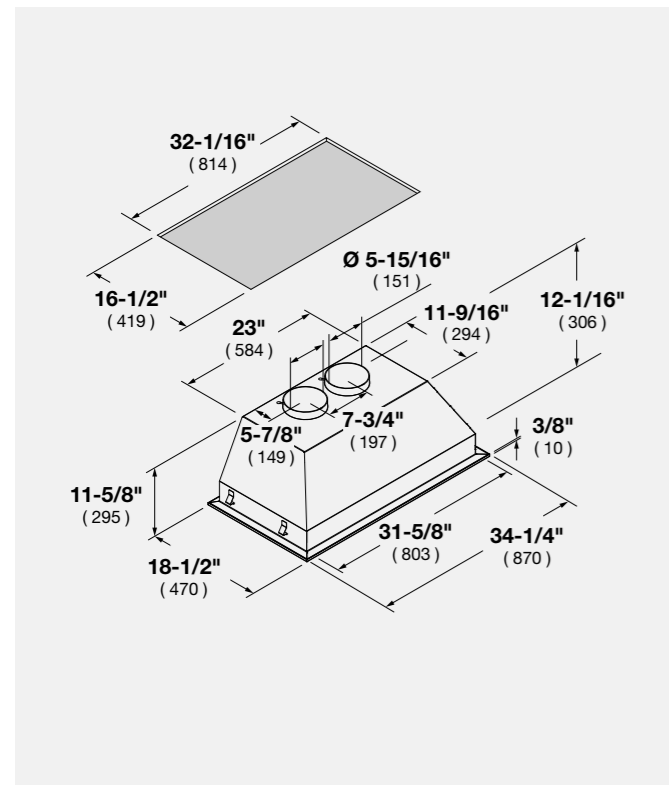

28" INSERT HOOD CODE ID F4BP28S1

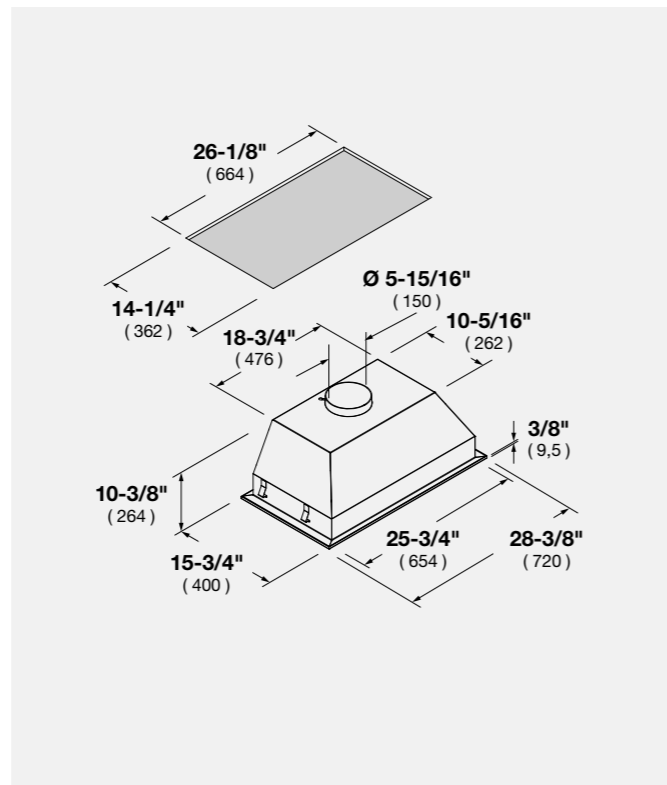

36" UNDERCABINET HOOD CODE ID F4UC36S1

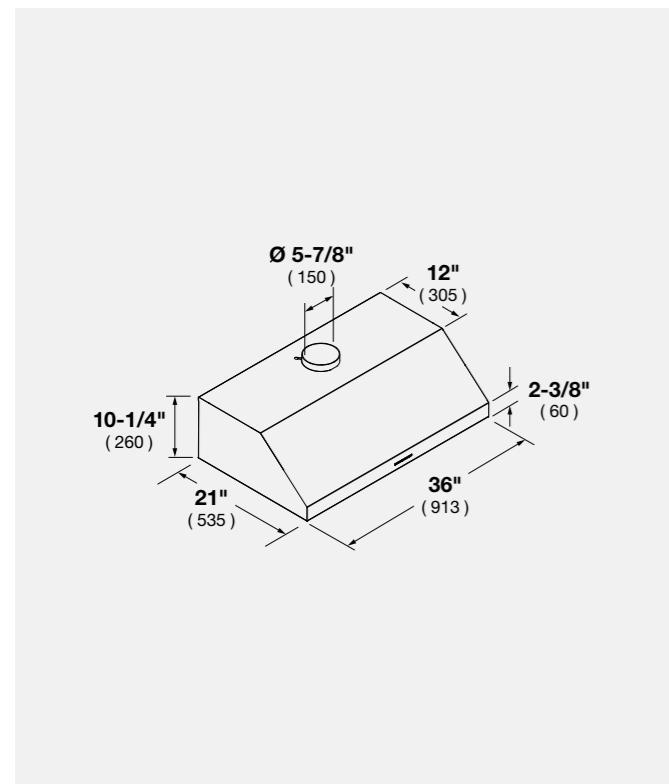

30" UNDERCABINET HOOD CODE ID F4UC30S1

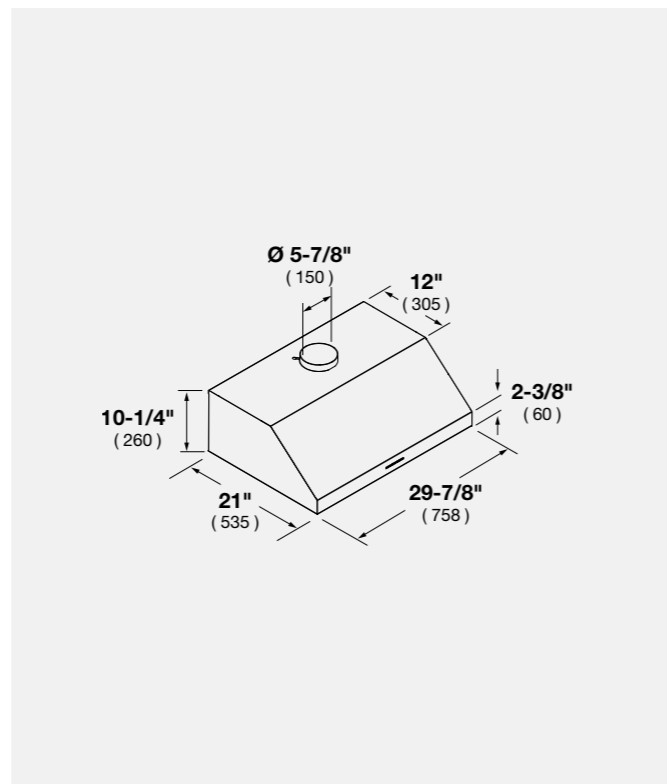

36" NEW BUILT-IN FRIDGE LEFT DOOR BUILT-IN FRIDGE RIGHT DOOR CODE ID F7IBM36O1-L CODE ID F7IBM36O1-R

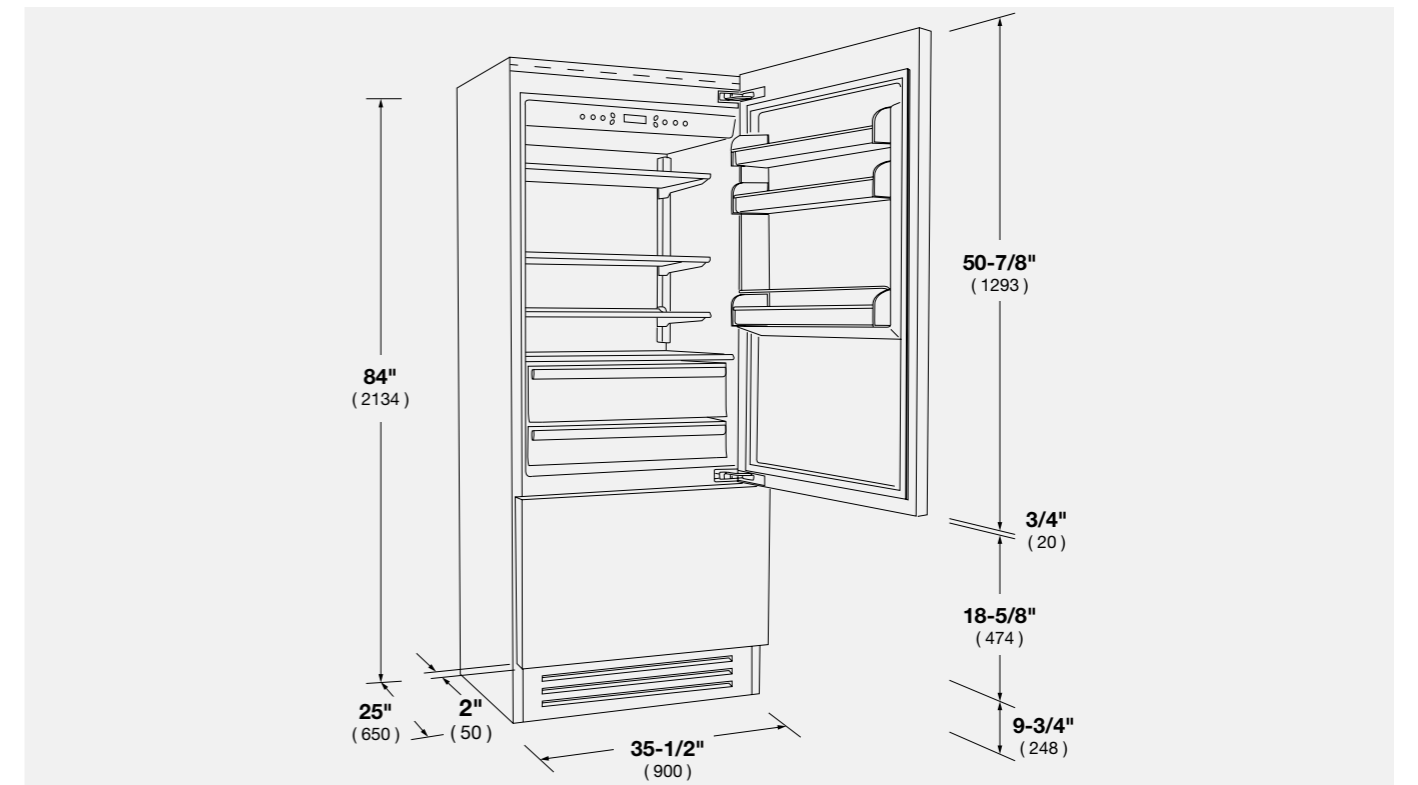

24" NEW BUILT-IN WINE CELLAR LEFT DOOR BUILT-IN WINE CELLAR RIGHT DOOR CODE ID F7IBW24O1-L CODE ID F7IBW24O1-R

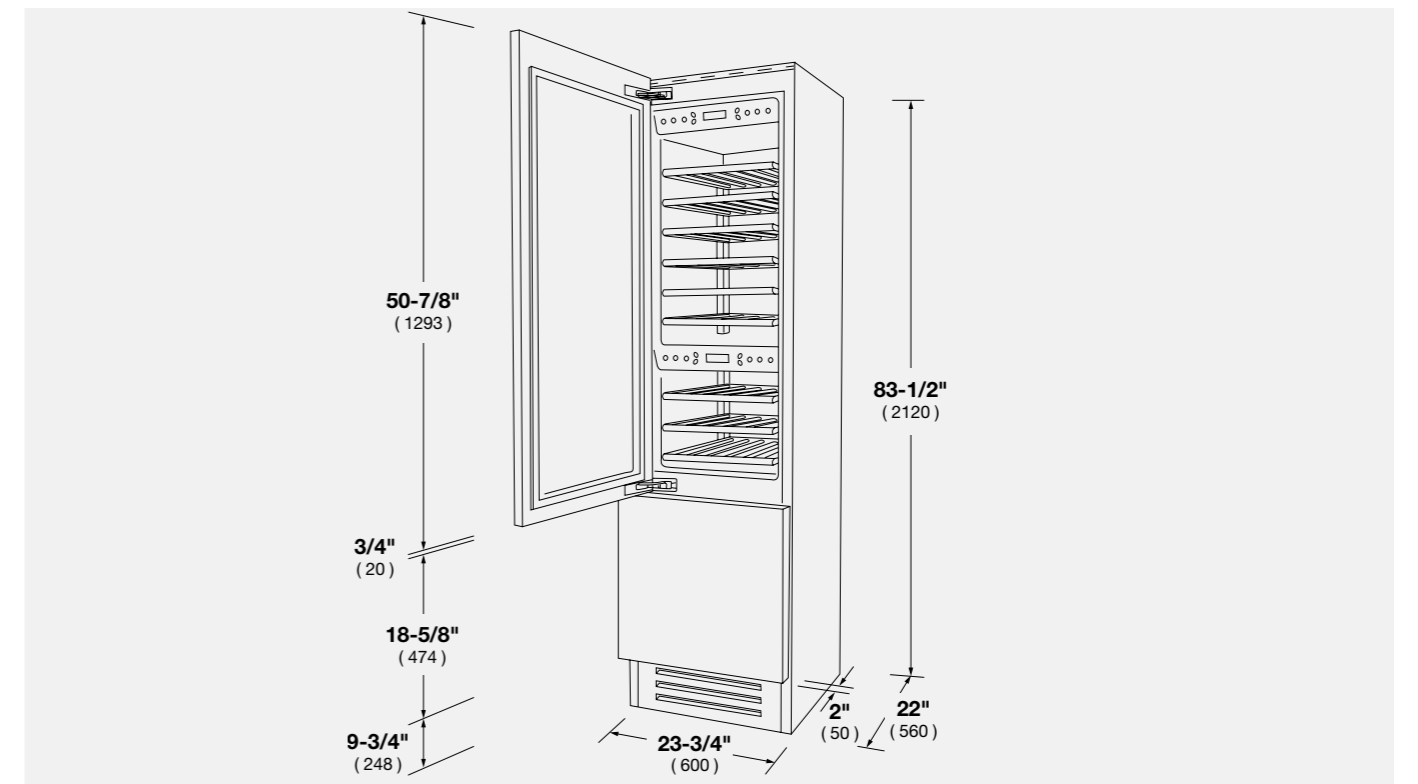

24"

INTEGRATED DISHWASHERS

CODE ID F6DW24SS1

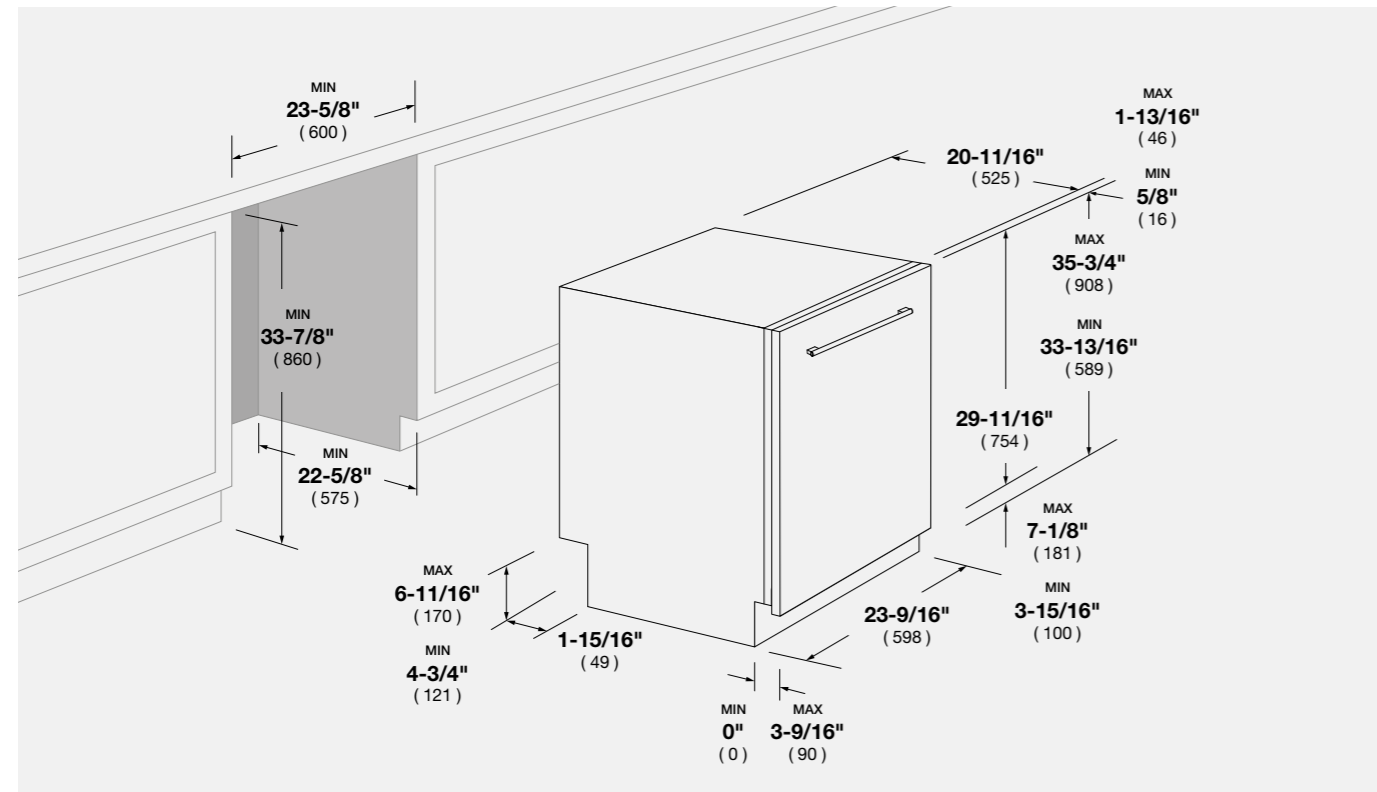

FULGOR
MILANO

TECHNICAL
DATA
PROFESSIONAL

24"

FULLY INTEGRATED DISHWASHERS

CODE ID F6DW24FI1

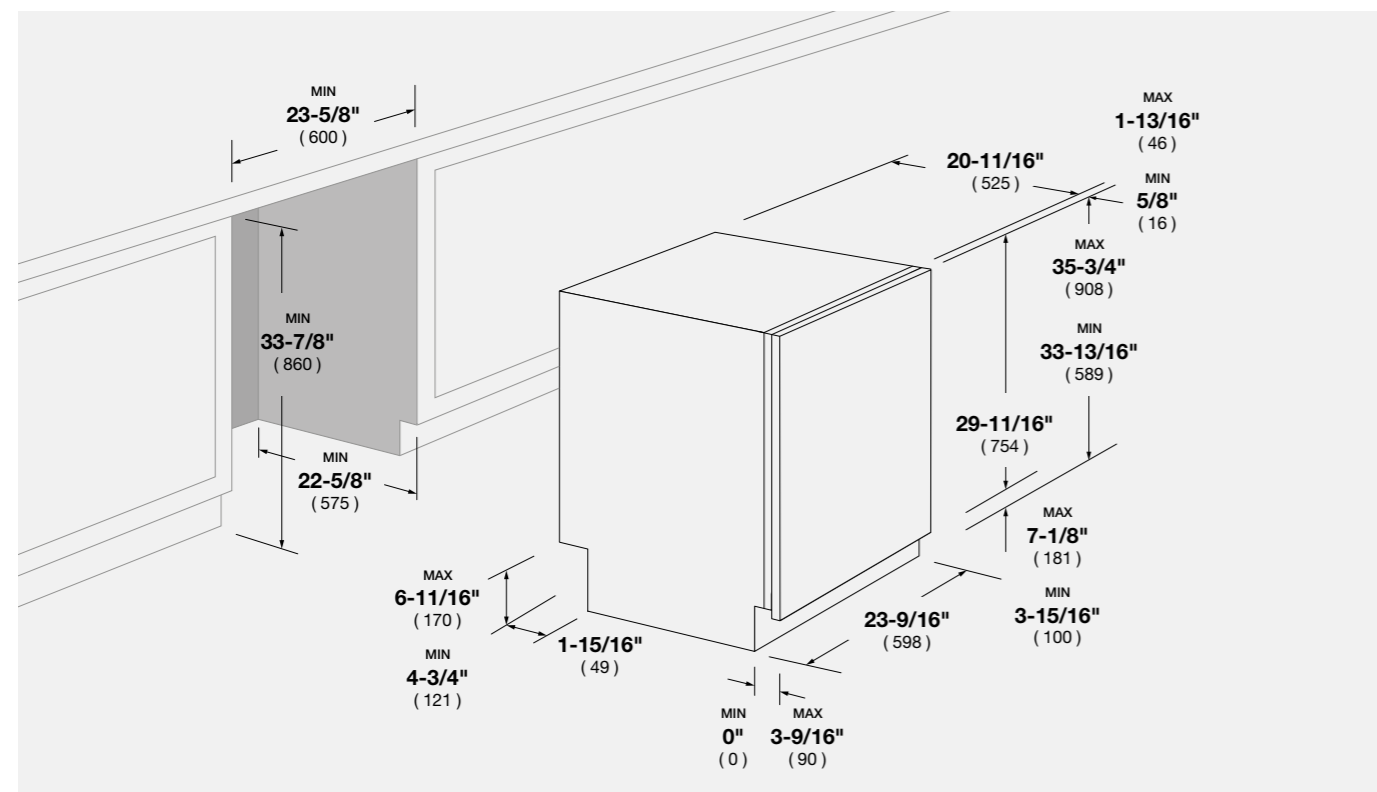

NEW

SOFIA

DUAL FUEL PROFESSIONAL RANGE



CODE ID	48" DUAL FUEL PROFESSIONAL RANGE F6PDF486GS1			
Series	600			
Finish	Professional Design - Stainless Steel			
CONTROL PANEL				
Control Type	11 Heavy Duty Knobs			
Oven Programming	Electronic with 6 Touch Keys			
Display: Clock - Temperature - Function	White LED			
Language	English			
COOKTOP				
Type	GAS (NG or LP)			
Cooking Surface	Matte Black Enamel			
GAS COOKTOP FEATURES				
	Electric Re-ignition system	Dual Crown Burners (Brass or Aluminum)		
	Flame-out sensing	Griddle (flat or with rack)		
	Top Mount Injectors	Pressure Regulator		
	L.P. Conversion Kit			
Heavy Duty Cast Iron Grates	3			
Cooking Zones	6 Burner + Griddle			
Burners types	All Dual Flame/Simmer Burner			
Front-L/Front-R - Power (Max/Min) G20 - 5"	20000 (BTU/h) - 5850W / 750 (BTU/h) - 220W			
Front-L/Front-R - Power (Max/Min) G31 - 10"	15000 (BTU/h) - 4400W / 750 (BTU/h) - 220W			
Rear-L/Front Center "Right"/Rear Center "Right"/Rear-R - Power (Max/Min) G20 - 5"	18000 (BTU/h) - 5300W / 750 (BTU/h) - 220W			
Rear-R/Front Center "Right"/Rear Center "Right"/Rear-R - Power (Max/Min) G31 - 10"	15000 (BTU/h) - 4400W / 750 (BTU/h) - 220W			
Griddle Burner (Center "Left")	Thermostat Control Griddle Burner - 12500 (BTU/h) - 3600W / 4200 (BTU/h) - 1250W			
	Power (Max/Min) G20 - 5"/G31 - 10"			
OVEN				
	18" (Accessory Oven)		30" (Main Oven)	
Type	Electric Self-clean - Dual Convection (True Euro Conv.)		Electric Self-clean - Dual Convection (True Euro Conv.)	
Temperature Regulation	Electronic Control (min/max 170/550°F - 75/290°C)		Electronic Control (min/max 170/550°F - 75/290°C)	
OVEN FUNCTIONS				
	Pyrolytic Self-Clean with automatic door latch	Bake	Pyrolytic Self-Clean with automatic door latch	Bake
	Convection Broil	Broil	Convection Broil	Broil
	Pizza (Lower Convection)	Oven Lights	Pizza (Lower Convection)	Oven Lights
ELECTRIC OVEN FEATURES				
	Preset/Last Used Temperature Memory	Preheat Indicator (25%, 50%, 75%, 100%)	Preset/Last Used Temperature Memory	Preheat Indicator (25%, 50%, 75%, 100%)
	Child Door Lock	Control Display Lock	Child Door Lock	Control Display Lock
	Automatic Fast Preheat	12/24 Hour Clock Formats	Automatic Fast Preheat	12/24 Hour Clock Formats
	Sabbath Mode	Temperature Display °C/°F	Sabbath Mode	Temperature Display °C/°F
	Meat Probe		Meat Probe	
OVEN DOOR(S)				
Oven Glass Window	Deep Embossed Window		Deep Embossed Window	
Door Cooling System	4 Heat Resistant Glasses		4 Heat Resistant Glasses	
Door Hinges - Soft-closing System	Heavy Duty Steady Tilt		Heavy Duty Steady Tilt	
Handle Style	Stainless Steel Tube Ø30mm, Metal End caps		Stainless Steel Tube Ø30mm, Metal End caps	
OVEN CAVITY				
Gross Capacity (cbft)	2.7		4.4	
Usable Capacity (cbft)	2.4		4.1	
Cavity Enamel Colour	Black		Black	
Rack Positions	6		6	
Oven Lights	1x20W Halogen		3x20W Halogen	
HEATING ELEMENTS (@240V)				
Broil Upper Heating Element	2100 W		3500 W	
Upper Auxiliary Element	700 W		1032 W	
Concealed Bake Lower Heating Element	1750 W		3000 W	
Convection Element	1 x 1300 W		2 x 1300 W	
OVEN ACCESSORIES				
Chromed Racks	2		2	
Enameled Broiler Pan (basin + anti splash)	-		1	
Telescopic Chromed Rack	1		1	
DIMENSIONS/WEIGHT				
Overall dim - Width	47 - 3/4" (1216 mm)			
Overall dim - Height (min - max)	36 3/8", 38 1/4" (923 mm) - (972 mm)			
Overall dim - Depth	29 - 3/4" (756 mm)			
Gross Weight	529 lbs (240 kg)			
POWER / RATINGS (208/240 V, 60 HZ)				
kW / Amps rating at 120-240V, 60Hz	6.08 kW - 26.7A			
kW / Amps rating at 120-208V, 60Hz	5.73 kW - 28.3A			
Power Cable	Nema 14-50P			
INSTRUCTIONS FOR USE				
Use & Care Manual / Installation Manual	English / French / Spanish			

SOFIA

DUAL FUEL PROFESSIONAL RANGE



CODE ID	36" DUAL FUEL PROFESSIONAL RANGE F6PDF366S1		30" DUAL FUEL PROFESSIONAL RANGE F6PDF304S1	
Series	600		600	
Finish	Professional Design - Stainless Steel		Professional Design - Stainless Steel	
CONTROL PANEL				
Control Type	8 Heavy Duty Knobs		6 Heavy Duty Knobs	
Oven Programming	Electronic with 6 Touch Keys		Electronic with 6 Touch Keys	
Display: Clock - Temperature - Function	White LED		White LED	
Language	English / French / Spanish		English / French / Spanish	
COOKTOP				
Type	GAS (NG or LP)		GAS (NG or LP)	
Cooking Surface	Matte Black Enamel		Matte Black Enamel	
GAS COOKTOP FEATURES				
	Electric Re-ignition system	•		
	Flame-out sensing	•		
	Top Mount Injectors	•		
	L.P. Conversion Kit	•		
	Dual Crown Brass Burner	•		
	Heavy Duty Cast Iron Grates	3		
	Cooking Zones	6		
Burners types	All Dual Flame/Simmer Burner		All Dual Flame/Simmer Burner	
Power Front-L,Front-R (Max/Min) NG	20000 (BTU/h) - 5900W / 750 (BTU/h) - 220W		-	
Power Front-R (Max/Min) NG	-		20000 (BTU/h) - 5900W / 750 (BTU/h) - 220W	
Power (Max/Min) NG	18000 (BTU/h) - 5300W / 750 (BTU/h) - 220W		18000 (BTU/h) - 5300W / 750 (BTU/h) - 220W	
Power (Max/Min) LP	15000 (BTU/h) - 4400W / 750 (BTU/h) - 220W		15000 (BTU/h) - 4400W / 750 (BTU/h) - 220W	
OVEN				
Type	Electric Self-clean - Dual Convection (True Euro Conv.)		Electric Self-clean - Dual Convection (True Euro Conv.)	
Temperature Regulation	Electronic Control (min/max 170/550°F - 75/290°C)		Electronic Control (min/max 170/550°F - 75/290°C)	
OVEN FUNCTIONS				
	Pyrolytic Self-Clean	Dehydrate	Pyrolytic Self-Clean	Dehydrate
	True Convection	Thaw (Defrost)	True Convection	Thaw (Defrost)
	Convection Broil	Proof (Warm)	Convection Broil	Proof (Warm)
	Convection Roast	Keep warm (Warm Plus)	Convection Roast	Keep warm (Warm Plus)
	Pizza (Lower Convection)	Oven Lights	Pizza (Lower Convection)	Oven Lights
	Bake	Broil	Bake	Broil
ELECTRIC OVEN FEATURES				
	Preset/Last Used Temperature Memory	Preheat Indicator (25%, 50%, 75%, 100%)	Preset/Last Used Temperature Memory	Preheat Indicator (25%, 50%, 75%, 100%)
	Child Door Lock	Control Display Lock	Child Door Lock	Control Display Lock
	Fast Preheat	12/24 Hour Clock Formats	Fast Preheat	12/24 Hour Clock Formats
	Sabbath Mode	Temperature Display °C/°F	Sabbath Mode	Temperature Display °C/°F
	Meat Probe		Meat Probe	
OVEN DOOR(S)				
Oven Glass Window	Deep Embossed Extra Wide Window		Deep Embossed Extra Wide Window	
Door Cooling System	4 Heat Resistant Glasses		4 Heat Resistant Glasses	
Door Hinges - Soft-closing System	Heavy Duty Steady Tilt		Heavy Duty Steady Tilt	
Handle Style	Stainless Steel Tube with Metal End caps		Stainless Steel Tube with Metal End caps	
OVEN CAVITY				
Gross Capacity (cbft)	5.7		4.4	
Usable Capacity (cbft)	4.9		4.1	
Cavity Enamel Colour	Black		Black	
Rack Positions	6		6	
Oven Lights	3x20W Halogen		3x20W Halogen	
HEATING ELEMENTS (@240V)				
Broil Upper Heating Element	3500 W		3500 W	
Upper Auxiliary Element	1032 W		1032 W	
Concealed Bake Lower Heating Element	3000 W		3000 W	
Convection Element	2 x 1300 W		2 x 1300 W	
OVEN ACCESSORIES				
Chromed Racks	2		2	
Enameled Broiler Pan (basin + anti splash)	1		1	
Telescopic Chromed Rack	1		1	
DIMENSIONS/WEIGHT				
Overall dim - Width	35 - 3/4" (910 mm)		29 - 3/4" (758 mm)	
Overall dim - Height (min - max)	36 3/8", 38 1/4" (923 mm) - (972 mm)		36 3/8", 38 1/4" (923 mm) - (972 mm)	
Overall dim - Depth	29 - 3/4" (756 mm)		29 - 3/4" (756 mm)	
Gross Weight	382 lbs (174 kg)		326 lbs (148 kg)	
POWER / RATINGS (208/240 V, 60 HZ)				
kW / Amps rating at 120-240V, 60Hz	3.84 kW - 16.9A		3.84kW - 16.9A	
kW / Amps rating at 120-208V, 60Hz	3.54 kW - 17.5A		3.54kW - 17.5A	
Power Cable	Nema 14-50P		Nema 14-50P	
INSTRUCTIONS FOR USE				
Use & Care Manual / Installation Manual	English / French / Spanish		English / French / Spanish	

SOFIA

ALL GAS PROFESSIONAL RANGE



CODE ID	36" ALL GAS PROFESSIONAL RANGE F6PGR366S2	30" ALL GAS PROFESSIONAL RANGE F6PGR304S2
Series	600	600
Finish	Professional Design - Stainless Steel	Professional Design - Stainless Steel
CONTROL PANEL		
Control Type	8 Heavy Duty Knobs	6 Heavy Duty Knobs
Display: Temperature - Function	White LED	White LED
Ignition/Temperature control	Electronic Control (min/max 170/550°F)	Electronic Control (min/max 170/550°F)
COOKTOP		
Type	GAS (NG or LP)	GAS (NG or LP)
Cooking Surface	Matte Black Enamel	Matte Black Enamel
GAS COOKTOP FEATURES		
Electric Re-ignition system	•	•
Flame-out sensing	•	•
Top Mount Injectors	•	•
L.P. Conversion Kit	•	•
Dual Crown Brass Burner	•	•
Heavy Duty Cast Iron Grates	3	2
Cooking Zones	6	4
Burners types	All Dual Flame/Simmer Burner	All Dual Flame/Simmer Burner
Power Front-L,Front-R (Max/Min) NG	20000 (BTU/h) - 5900W / 750 (BTU/h) - 220W	-
Power Front-R (Max/Min) NG	-	20000 (BTU/h) - 5900W / 750 (BTU/h) - 220W
Power (Max/Min) NG	18000 (BTU/h) - 5300W / 750 (BTU/h) - 220W	18000 (BTU/h) - 5300W / 750 (BTU/h) - 220W
Power (Max/Min) LP	15000 (BTU/h) - 4400W / 750 (BTU/h) - 220W	15000 (BTU/h) - 4400W / 750 (BTU/h) - 220W
OVEN		
Type	Gas - Dual Convection	Gas - Dual Convection
Temperature Regulation	Electronic thermostat control	Electronic thermostat control
OVEN FUNCTIONS		
	Bake	Bake
	Broil	Broil
	Pizza	Pizza
GAS OVEN FEATURES		
	Electronic Flame Ignition	Electronic Flame Ignition
	Flame-out Sensing	Flame-out Sensing
	Flame-out Auto-off	Flame-out Auto-off
	Sabbath Mode	Sabbath Mode
	L.P. Conversion Kit	L.P. Conversion Kit
OVEN DOOR(S)		
Oven Glass Window	Deep Embossed Extra Wide Window	Deep Embossed Extra Wide Window
Door Cooling System	4 Heat Resistant Glasses	4 Heat Resistant Glasses
Door Hinges - Soft-closing System	Heavy Duty Steady Tilt	Heavy Duty Steady Tilt
Handle Style	Stainless Steel Tube with Metal End caps	Stainless Steel Tube with Metal End caps
OVEN CAVITY		
Gross Capacity (cbft)	5.7	4.4
Usable Capacity (cbft)	4.4	3.6
Cavity Enamel Colour	Black	Black
Rack Positions	6	6
Oven Lights	3x20W Halogen	3x20W Halogen
NOVA BROILER SYSTEM BURNER		
Power (Max) NG	18000 (BTU/h) - 5300W	14000 (BTU/h) - 4102W
Power (Max) LP	17000 (BTU/h) - 5000W	13000 (BTU/h) - 3800W
BAKE BURNER		
Power (Max) NG	21500 (BTU/h) - 6300W	18000 (BTU/h) - 5300W
Power (Max) LP	21500 (BTU/h) - 6300W	16000 (BTU/h) - 4700W
OVEN ACCESSORIES		
Chromed Racks	2	2
Enameled Broiler Pan (basin + anti splash)	1	1
Telescopic Chromed Rack	1	1
DIMENSIONS/WEIGHT		
Overall dim - Width	35 - 3/4" (910 mm)	29 - 3/4" (758 mm)
Overall dim - Height (min - max)	36 3/8", 38 1/4" (923 mm) - (972 mm)	36 3/8", 38 1/4" (923 mm) - (972 mm)
Overall dim - Depth	29 - 3/4" (756 mm)	29 - 3/4" (756 mm)
Gross Weight	377 lbs (171 kg)	322 lbs (146 kg)
POWER / RATINGS (120 V, 60 HZ)		
Watts / Amps	200W - 1.7A	200W - 1.7A
Power Cable	Nema 5-15P	Nema 5-15P
INSTRUCTIONS FOR USE		
Use & Care Manual / Installation Manual	English / French / Spanish	English / French / Spanish

SOFIA

INDUCTION PROFESSIONAL RANGE



CODE ID	36" INDUCTION PROFESSIONAL RANGE F6PIR365S1	30" INDUCTION PROFESSIONAL RANGE F6PIR304S1
Series	600	600
Finish	Professional Design - Stainless Steel	Professional Design - Stainless Steel
CONTROL PANEL		
Control Type	8 Heavy Duty Knobs	6 Heavy Duty Knobs
Oven Programming	Electronic with 6 Touch Keys	Electronic with 6 Touch Keys
Display: Clock - Temperature - Function	White LED	White LED
Language	English	English / French / Spanish
COOKTOP		
Type	INDUCTION	INDUCTION
Cooking Surface	Ceramic Glass	Ceramic Glass
INDUCTION COOKTOP FEATURES		
Pot Detection System	Residual Heat Indication	Pot Detection System
Melting Function	Simmering Function	Melting Function
113°F / 45°C	158°F / 70°C (113°F / 45°C
Digital Display	Booster/Fast Boil	Digital Display
for Power Level	Function for Each Zone	for Power Level
Failure Codes Indication	Power Levels: 1 to 9	Failure Codes Indication
Cooling Fan System	Heat up time automatic	Cooling Fan System
Child Lock Function	Digital minute minder	Child Lock Function
Knob for power setting	Cooking Zones: 5	Knob for power setting
Burners types (Front-L) - Power (Max/Booster)	Inductor 9" (230 mm) 2300W / 3700W	Inductor 9" (230 mm) 2300W / 3700W
Burners types (Rear-L) - Power (Max/Booster)	Inductor 7 - 3/4" (200 mm) 1850W / 3000W	Inductor 6 - 1/2" (165 mm) 1400W / 2200W
Burners types (Center dual circuit) - Power (Max/Booster)	Inductor 11" (280 mm) 3000W / 5500W	-
Burners types (Center single circuit) - Power (Max/Booster)	Inductor 7 - 3/4" (200 mm) 1850W / 2600W	-
Burners types (Front-R) - Power (Max/Booster)	Inductor 9" (230 mm) 2300W / 3700W	Inductor 7 - 3/4" (200 mm) 1850W / 3000W
Burners types (Rear-R) - Power (Max/Booster)	Inductor 7 - 3/4" (200 mm) 1850W / 3000W	Inductor 7 - 3/4" (200 mm) 1850W / 3000W
OVEN		
Type	Electric Self-clean - Dual Convection (True Euro Conv.)	Electric Self-clean - Dual Convection (True Euro Conv.)
Temperature Regulation	Electronic Control (min/max 170/550°F - 75/290°C)	Electronic Control (min/max 170/550°F - 75/290°C)
OVEN FUNCTIONS		
	Pyrolytic Self-Clean	Pyrolytic Self-Clean
	True Convection	True Convection
	Convection Broil	Convection Broil
	Convection Roast	Convection Roast
	Pizza (Lower Convection)	Pizza (Lower Convection)
	Bake	Bake
	Broil	Broil
	Dehydrate	Dehydrate
	Thaw (Defrost)	Thaw (Defrost)
	Proof (Warm)	Proof (Warm)
	Keep warm (Warm Plus)	Keep warm (Warm Plus)
	Oven Lights	Oven Lights
ELECTRIC OVEN FEATURES		
	Preset/Last Used	Preset/Last Used
	Temperature Memory	Temperature Memory
	Child Door Lock	Child Door Lock
	Automatic Fast Preheat	12/24 Hour Clock Formats
	Sabbath Mode	Temperature Display °C/°F
	Meat Probe	Meat Probe
	Preheat Indicator	Preheat Indicator
	(25%, 50%, 75%, 100%)	(25%, 50%, 75%, 100%)
	Control Display Lock	Control Display Lock
	12/24 Hour Clock Formats	12/24 Hour Clock Formats
	Temperature Display °C/°F	Temperature Display °C/°F
OVEN DOOR(S)		
Oven Glass Window	Deep Embossed Window	Deep Embossed Extra Wide Window
Door Cooling System	4 Heat Resistant Glasses	4 Heat Resistant Glasses
Door Hinges - Soft-closing System	Heavy Duty Steady Tilt	Heavy Duty Steady Tilt
Handle Style	Stainless Steel Tube Ø30mm, Pro Style	Stainless Steel Tube with Metal End caps
OVEN CAVITY		
Gross Capacity (cbft)	5.7	4.4
Usable Capacity (cbft)	4.9	4.1
Cavity Enamel Colour	Black	Black
Rack Positions	6	6
Oven Lights	3x20W Halogen	3x20W Halogen
HEATING ELEMENTS (@240V)		
Broil Upper Heating Element	3500 W	3500 W
Upper Auxiliary Element	1032 W	1032 W
Concealed Bake Lower Heating Element	3000 W	3000 W
Convection Element	2 x 1300 W	2 x 1300 W
OVEN ACCESSORIES		
	2 Chromed Racks	1 Telescopic Chromed Rack
	1 Enameled Broiler Pan (basin + anti splash)	1 Enameled Broiler Pan (basin + anti splash)
DIMENSIONS/WEIGHT		
Overall dim - Width	35 - 3/4" (910 mm)	29 - 3/4" (758 mm)
Overall dim - Height (min - max)	36 3/8", 38 1/4" (923 mm) - (972 mm)	36 3/8", 38 1/4" (923 mm) - (972 mm)
Overall dim - Depth	29 - 3/4" (756 mm)	29 - 3/4" (756 mm)
Gross Weight	382 lbs (174 kg)	311 lbs (141 kg)
POWER / RATINGS (208/240 V, 60 HZ)		
kW / Amps rating at 120-240V, 60Hz	12kW - 45.8A (Limited Maximum Output Amp.)	11kW - 45.8A
kW / Amps rating at 120-208V, 60Hz	10kW - 48.5A (Limited Maximum Output Amp.)	10kW - 48.5A
Power Cable	Nema 14-50P	Nema 14-50P
INSTRUCTIONS FOR USE		
Use & Care Manual / Installation Manual	English / French / Spanish	English / French / Spanish

SOFIA

PROFESSIONAL OVEN



CODE ID	30" PROFESSIONAL SINGLE OVEN F6PSP30S1		30" PROFESSIONAL DOUBLE OVEN F6PDP30S1	
Series	600		600	
Finish	Professional Design - Stainless Steel		Professional Design - Stainless Steel	
CONTROL PANEL				
Control Type	2 Heavy Duty Knobs		2 Heavy Duty Knobs	
Oven Programming	Electronic with 6 Touch Keys		Electronic with 6 Touch Keys	
Display: Clock - Temperature - Timer	White LED		White LED	
Language	English		English	
OVEN				
Type	Dual True Convection		Dual True Convection	
Temperature Regulation	Electronic Control (min/max 170/550°F - 75/290°C)		Electronic Control (min/max 170/550°F - 75/290°C)	
OVEN FUNCTIONS				
	Pyrolytic Self-Clean	Broil	Pyrolytic Self-Clean	Broil
	True Convection	Dehydrate	True Convection	Dehydrate
	Convection Bake	Thaw (Defrost)	Convection Bake	Thaw (Defrost)
	Convection Broil	Proof (Warm)	Convection Broil	Proof (Warm)
	Convection Roast	Keep warm (Warm Plus)	Convection Roast	Keep warm (Warm Plus)
	Pizza (Lower Convection)	Oven Lights	Pizza (Lower Convection)	Oven Lights
	Bake		Bake	
ELECTRIC OVEN FEATURES				
	Preset/Last Used Temperature Memory	Preheat Indicator (25%, 50%, 75%, 100%)	Preset/Last Used Temperature Memory	Preheat Indicator (25%, 50%, 75%, 100%)
	Control Display Lock	Sabbath Mode	Control Display Lock	Sabbath Mode
	Child Door Lock	Temperature Display °C/°F	Child Door Lock	Temperature Display °C/°F
	Meat Probe		Meat Probe (Upper Oven Only)	
OVEN DOOR(S)				
Oven Glass Window	Large See Through Glass		Large See Through Glass	
Door Cooling System	4 Heat Resistant Glasses		4 Heat Resistant Glasses	
Door Hinges - Soft-closing System	Heavy Duty Steady Tilt		Heavy Duty Steady Tilt	
Handle Style	Tubular Steel		Tubular Steel	
OVEN CAVITY				
Gross Capacity (cbft)	4.4		4.4	
Usable Capacity (cbft)	4.1		4.1	
Cavity Enamel Colour	Black		Black	
Rack Positions	6		6	
Oven Lights	3x20W Halogen		3x20W Halogen	
HEATING ELEMENTS (@240V)				
Broil Upper Heating Element	3500 W		3500 W	
Upper Auxiliary Element	1032 W		1032 W	
Concealed Bake Lower Heating Element	3000 W		3000 W	
Convection Element	2 x 1300 W		2 x 1300 W	
OVEN ACCESSORIES				
Chromed Racks	2		2 on both ovens	
Enameled Broiler Pan (basin + anti splash)	1		1 on both ovens	
Telescopic Chromed Rack	1		1 on both ovens	
DIMENSIONS/WEIGHT				
Overall dim - Width	29 - 11/16"	(754 mm)	29 - 11/16"	(754 mm)
Overall dim - Height	27 - 7/8"	(707 mm)	51"	(1295 mm)
Overall dim - Depth	24"	(610 mm)	24"	(610 mm)
Cut-out - Width	28 - 7/16"	(722 mm)	28 - 7/16"	(722 mm)
Cut-out - Height (min)	27 - 3/8"	(696 mm)	50"	(1270 mm)
Cut-out - Depth (min)	23 - 1/4"	(590 mm)	23 - 1/4"	(590 mm)
Gross Weight	198 lbs	(90 kg)	340 lbs	(154 kg)
POWER / RATINGS (208/240 V, 60 HZ)				
kW / Amps rating at 240V, 60Hz	3.84 kW - 16.9A		7.68 kW - 33.8A	
kW / Amps rating at 208V, 60Hz	3.54 kW - 17.5A		6.48 kW - 32.4A	
Power Cable	Conduit		Conduit	
INSTRUCTIONS FOR USE				
Use & Care Manual / Installation Manual	English / French / Spanish		English / French / Spanish	

SOFIA

PROFESSIONAL WARMING DRAWER



CODE ID	30" PROFESSIONAL WARMING DRAWER F6PWD30S1	
Type	Warming Drawer	
Front finish	Stainless Steel with Pro - Handle	
Internal shelf	Inox	
Compatible with ovens	F6PSP30S1 - F6PDP30S1	
PERFORMANCE		
Maximum temperature	194°F / 90°C	
Cooking at low temperature (slow cooking)	•	
Leavening	•	
Heating dishes and food	•	
Slow close assistance	•	
Open / Close push - pull system	-	
CONTROL		
Thermostat	86°F - 194°F / 30°C - 90°C	
Fan assisted	•	
Function Indicator / Thermostat on/off	•	
SAFETY		
Safety front	•	
ELECTRICAL SPECIFICATIONS		
Max power absorbed (W)	1500W	
Power (V-Hz)	120/60	
Power cord	•	
Plug	•	
CAPACITY		
Volume (cbft-litri)	2,1	61.4
DIMENSIONS		
Overall dim - Width	29 7/8"	(758 mm)
Overall dim - Height	10 3/8"	(264 mm)
Overall dim - Depth	22 3/4"	(578 mm)
Door Depth with Overlay	2 1/8"	(54 mm)
Door Depth with Pro Handle	4 11/16"	(119 mm)
Cut-out - Width	28 5/8"	(727 mm)
Cut-out - Height	9 1/8"	(235 mm)
Cut-out - Depth	24"	(610 mm)
WEIGHT		
Net Weight	70 lbs	31.5 Kg
Gross Weight	79 lbs	35.6 Kg

SOFIA

PROFESSIONAL GAS RANGE TOP



CODE ID	36" PROFESSIONAL GAS RANGE TOP F6GRT366S1	30" PROFESSIONAL GAS RANGE TOP F6GRT304S1
Series	600	600
Finish	Professional Design - Stainless Steel	Professional Design - Stainless Steel
CONTROL PANEL		
Control Type	6 Heavy Duty Knobs	4 Heavy Duty Knobs
COOKTOP		
Type	GAS (NG or LP)	GAS (NG or LP)
Cooking Surface	Matte Black Enamel	Matte Black Enamel
GAS COOKTOP FEATURES		
Electric Re-ignition system	•	•
Flame-out sensing	•	•
Top Mount Injectors	•	•
Dual Crown Brass Burner	•	•
Simmer Plate	Optional	Optional
Wok Ring	Optional	Optional
Heavy Duty Cast Iron Grates	3	2
Cooking Zones	6	4
Burners types	All Dual Flame/Simmer Burner	All Dual Flame/Simmer Burner
Power Front-L,Front-R (Max/Min) NG	20000 (BTU/h) - 5900W / 750 (BTU/h) - 220W	-
Power Front-R (Max/Min) NG	-	20000 (BTU/h) - 5900W / 750 (BTU/h) - 220W
Power (Max/Min) NG	18000 (BTU/h) - 5300W / 750 (BTU/h) - 220W	18000 (BTU/h) - 5300W / 750 (BTU/h) - 220W
Power (Max/Min) LP	15000 (BTU/h) - 4400W / 750 (BTU/h) - 220W	15000 (BTU/h) - 4400W / 750 (BTU/h) - 220W
DIMENSIONS/WEIGHT		
Overall dim - Width	35 - 3/4" (910 mm)	29 - 3/4" (758 mm)
Overall dim - Height	7" (179 mm)	7" (179 mm)
Overall dim - Depth	29 - 3/4" (756 mm)	29 - 3/4" (756 mm)
Cut-out - Width	36" (914 mm)	30" (762 mm)
Cut-out - Height (min)	7" (179 mm)	7" (179 mm)
Cut-out - Depth (min - max)	24", 25 - 1/2" (610 mm) - (650 mm)	24", 25 - 1/2" (610 mm) - (650 mm)
Gross Weight	121 lbs (55 kg)	100 lbs (45 kg)
POWER / RATINGS (120 V, 60 HZ)		
Amps	0.1A	0.1A
Power Cable	Nema 5-15P	Nema 5-15P
INSTRUCTIONS FOR USE		
Use & Care Manual / Installation Manual	English / French / Spanish	English / French / Spanish

SOFIA

PROFESSIONAL INDUCTION RANGE TOP



CODE ID	30" PROFESSIONAL INDUCTION RANGE TOP F6IRT304S1
Series	600
Finish	Professional Design - Ceramic and Stainless Steel
CONTROL PANEL	
Control Type	4 Heavy Duty Knobs
COOKTOP	
Type	INDUCTION
Cooking Surface	Ceramic Glass
INDUCTION COOKTOP FEATURES	
Pot Detection System	•
Child Lock Function	•
Failure Codes Indication	•
Knob for Power Setting (illuminated)	•
Power Levels	1 to 9
Digital Display for Power Level	Optional
Melting Function 113°F / 45°C	2
Warming Function 158°F / 70°C	4
Booster/Fast Boil Function for Each Zone	•
Automatic Heat-up Time	•
Residual Heat Indication	•
Cooking Zones	4
Burners types (Front-L) - Power (Max/Booster)	Inductor 9" (230 mm) 2300W / 3700W
Burners types (Rear-L) - Power (Max/Booster)	Inductor 6 - 1/2" (165 mm) 1400W / 2200W
Burners types (Front/Rear-R)	Inductor 7 - 3/4" (200 mm) 1850W / 3000W
Power (Max/Booster)	
DIMENSIONS/WEIGHT	
Overall dim - Width	29 - 3/4" (758 mm)
Overall dim - Height	7" (179 mm)
Overall dim - Depth	29 - 3/4" (756 mm)
Cut-out - Width	30" (762 mm)
Cut-out - Height (min)	7" (179 mm)
Cut-out - Depth (min - max)	24", 25 - 3/8" (610 mm) - (644 mm)
Gross Weight	100 lbs (45 kg)
POWER / RATINGS (120 V, 60 HZ)	
kW / Amps rating at 240V, 60Hz	7.2 kW - 30A
Power Cable	Conduit
INSTRUCTIONS FOR USE	
Use & Care Manual / Installation Manual	English / French / Spanish

NEW

SOFIA

PROFESSIONAL PRO GAS COOK TOP



CODE ID	36" PROFESSIONAL PRO GAS COOK TOP F6PGK365S1	
Series	600	
Finish	Stainless Steel	
CONTROL PANEL		
Control Type	Knobs	
COOKTOP		
Type	GAS (NG or LP)	
Cooking Surface	Matte Black Enamel	
GAS COOKTOP FEATURES		
Electric Re-ignition system	•	
Flame-out sensing	•	
Dual Crown Brass Burner	•	
Simmer Plate	Optional	
Small Pot Insert (for single burners only)	Optional	
Wok Ring (for dual burner only)	Optional	
Heavy Duty Cast Iron Grates	3	
Cooking Zones	5	
Burners types	All Dual Flame/Simmer Burner	
Power (Max/Min) (Front-L)	18000 (BTU/h) - 5275W / 1300 (BTU/h) - 382W	
Power (Max/Min) (Rear-L)	18000 (BTU/h) - 5275W / 1300 (BTU/h) - 382W	
Power (Max/Min) (Front Center)	20000 (BTU/h) - 5880W / 1000 (BTU/h) - 294W	
Power (Max/Min) (Rear-R)	18000 (BTU/h) - 5275W / 1300 (BTU/h) - 382W	
Power (Max/Min) (Front-R)	18000 (BTU/h) - 5275W / 1300 (BTU/h) - 382W	
DIMENSIONS/WEIGHT		
Overall dim - Width	36"	(914 mm)
Overall dim - Height	5 - 3/16"	(132 mm)
Overall dim - Depth	21"	(533 mm)
Cut-out - Width	35"	(889 mm)
Cut-out - Height (min)	3 - 15/16"	(74 mm)
Cut-out - Depth (min - max)	19 - 1/2"	(495 mm)
Gross Weight	55 lbs	(25 kg)
POWER / RATINGS (120 V, 60 HZ)		
Amps	0.1A	
Max Power	92000 (BTU/h) - 27000W	
Power Cable	Nema 5-15P	
INSTRUCTIONS FOR USE		
Use & Care Manual / Installation Manual	English / French / Spanish	

NEW

SOFIA

PROFESSIONAL PRO GAS COOK TOP



CODE ID	30" PROFESSIONAL PRO GAS COOK TOP F6PGK305S1	
Series	600	
Finish	Stainless Steel	
CONTROL PANEL		
Control Type	Knobs	
COOKTOP		
Type	GAS (NG or LP)	
Cooking Surface	Matte Black Enamel	
GAS COOKTOP FEATURES		
Electric Re-ignition system	•	
Flame-out sensing	•	
Dual Crown Brass Burner	•	
Simmer Plate	Optional	
Small Pot Insert (for single burners only)	Optional	
Wok Ring (for dual burner only)	Optional	
Heavy Duty Cast Iron Grates	2	
Cooking Zones	5	
Burners types	All Dual Flame/Simmer Burner	
Power (Max/Min) (Front-L)	18000 (BTU/h) - 5275W / 1300 (BTU/h) - 382W	
Power (Max/Min) (Rear-L)	18000 (BTU/h) - 5275W / 1300 (BTU/h) - 382W	
Power (Max/Min) (Center)	20000 (BTU/h) - 5880W / 1000 (BTU/h) - 294W	
Power (Max/Min) (Rear-R)	18000 (BTU/h) - 5275W / 1300 (BTU/h) - 382W	
Power (Max/Min) (Front-R)	18000 (BTU/h) - 5275W / 1300 (BTU/h) - 382W	
DIMENSIONS/WEIGHT		
Overall dim - Width	30"	(762 mm)
Overall dim - Height	5 - 3/16"	(132 mm)
Overall dim - Depth	21"	(533 mm)
Cut-out - Width	29"	(737 mm)
Cut-out - Height (min)	3 - 15/16"	(74 mm)
Cut-out - Depth (min - max)	19 - 1/2"	(495 mm)
Gross Weight	45 lbs	(20 kg)
POWER / RATINGS (120 V, 60 HZ)		
Amps	0.1A	
Max Power	92000 (BTU/h) - 27000W	
Power Cable	Nema 5-15P	
INSTRUCTIONS FOR USE		
Use & Care Manual / Installation Manual	English / French / Spanish	

NEW

NEW

SOFIA

PROFESSIONAL HOOD



CODE ID	48" PROFESSIONAL HOOD F6PH48DS1	36" PROFESSIONAL HOOD F6PH36DS1
Series	600	600
Finish	Professional Design - Stainless Steel (AISI 430)	Professional Design - Stainless Steel (AISI 430)
CONTROL PANEL		
Control Type	4 speed mechanical control	4 speed mechanical control
PERFORMANCES		
Output (CFM)	1000	1000
Sound Level (dB)	75	75
Motor	Twin Motor	Twin Motor
Venting Type	Ducted and recirculating	Ducted and recirculating
FEATURES		
Filter Style	Pro Baffle	Pro Baffle
Lighting	6 x 1.2W LED	4 x 1.2W LED
Single duct diameter	7 - 7/8" (200 mm)	7 - 7/8" (200 mm)
DIMENSIONS/WEIGHT		
Overall dim - Width	47 - 7/8" (1216 mm)	35 - 7/8" (910 mm)
Overall dim - Height	18" (460 mm)	18" (460 mm)
Overall dim - Depth	24" (610 mm)	24" (610 mm)
Gross Weight	90 lbs (41 kg)	70 lbs (30 kg)
POWER / RATINGS (115 V, 60 HZ)		
Watts / Amps	860W - 7.8A	860W - 7.8A
Power Cable	Nema 5-15P	Nema 5-15P
INSTRUCTIONS FOR USE		
Use & Care Manual / Installation Manual	English / French / Spanish	English / French / Spanish

NEW

NEW

SOFIA

PROFESSIONAL INSERT HOOD



CODE ID	48" PROFESSIONAL INSERT HOOD F6BP46DS1	36" PROFESSIONAL INSERT HOOD F6BP34DS1
Series	600	600
Finish	Stainless Steel (AISI 430)	Stainless Steel (AISI 430)
CONTROL PANEL		
Control Type	4+4 speed mechanical control	4+4 speed mechanical control
PERFORMANCES		
Output (CFM)	1000	1000
Sound Level (dB)	75	75
Motor	Twin Motor	Twin Motor
Venting Type	Ducted and recirculating	Ducted and recirculating
FEATURES		
Filter Style	Pro Baffle	Pro Baffle
Lighting	6 x 1.2W LED	4 x 1.2W LED
Duct diameter for each motor	5 - 15/16" (150 mm)	5 - 15/16" (150 mm)
DIMENSIONS/WEIGHT		
Overall dim - Width	45 - 3/4" (116 mm)	34 - 1/4" (87 mm)
Overall dim - Height	13 - 1/8" (33 mm)	13 - 1/8" (33 mm)
Overall dim - Depth	18 - 1/2" (47 mm)	18 - 1/2" (47 mm)
Cut-out (w x d)	43 - 7/16" x 16 - 1/2" (1092 x 419 mm)	32 - 1/16" x 16 - 1/2" (814 x 419 mm)
Gross Weight	68 lbs (31 kg)	60 lbs (27 kg)
Net Weight	57 lbs (26 kg)	51 lbs (23 kg)
POWER / RATINGS (115 V, 60 HZ)		
Watts / Amps	860W - 7.8A	860W - 7.8A
Power Cable	Nema 5-15P	Nema 5-15P
INSTRUCTIONS FOR USE		
Use & Care Manual / Installation Manual	English / French / Spanish	English / French / Spanish

SOFIA

PROFESSIONAL HOOD



CODE ID	36" PROFESSIONAL HOOD F6PH36S1	30" PROFESSIONAL HOOD F6PH30S1 - F6PH30S2
Series	600	600
Finish	Professional Design - Stainless Steel (AISI 430)	Professional Design - Stainless Steel (AISI 430)
CONTROL PANEL		
Control Type	4 speed mechanical control	4 speed mechanical control Knob Control (F6PH30S2)
PERFORMANCES		
Output (CFM)	600	600
Sound Level (dB)	72	72
Motor	One	One
Venting Type	Ducted and recirculating	Ducted and recirculating
FEATURES		
Filter Style	Pro Baffle	Pro Baffle
Lighting	2 x 1.2W LED	2 x 1.2W LED 4 x 1.2W LED (F6PH30S2)
Duct diameter	5 - 15/16" (150 mm)	5 - 15/16" (150 mm)
DIMENSIONS/WEIGHT		
Overall dim - Width	35 - 7/8" (910 mm)	29 - 13/16" (760 mm)
Overall dim - Height	18" (460 mm)	18" (460 mm)
Overall dim - Depth	24" (610 mm)	24" (610 mm)
Gross Weight	70 lbs (30 kg)	61 lbs (28 kg)
POWER / RATINGS (115 V, 60 HZ)		
Watts / Amps	430W - 3.8A	430W - 3.8A
Power Cable	Nema 5-15P	Nema 5-15P
INSTRUCTIONS FOR USE		
Use & Care Manual / Installation Manual	English / French / Spanish	English / French / Spanish

SOFIA

PROFESSIONAL FRIDGE
BUILT-IN FRIDGE

NEW



NEW



CODE ID	36" PROFESSIONAL FRIDGE F7PBM36S1-L (LEFT DOOR) F7PBM36S1-R (RIGHT DOOR)		36" BUILT-IN FRIDGE F7IBM36O1-L (LEFT DOOR) F7IBM36O1-R (RIGHT DOOR)	
Series	700		700	
Finish	Professional Design - Stainless Steel		Distinto - Overlay Panel	
PERFORMANCES/CAPACITY				
Annual Energy Usage	\$69 (571 kWh)		\$70 (580 kWh)	
Noise Level db	40		40	
Fridge compartment capacity (cbft)	14.7		14.7	
Flexzone Bottom-Drawer capacity (cbft)	3.8		3.8	
FEATURES				
Fridge Compartment				
Glass Shelves	2		2	
Adjustable Door Shelves	3		3	
Micro shot-peened Stainless Steel Drawers	2 Low Temp		2 Low Temp	
Flexzone Bottom-Drawer				
White Painted Drawers	1		1	
Internal Drawers	1 + 1 ice tray		1 + 1 ice tray	
LED lighting	•		•	
Ice Maker	•		•	
Equipment				
No Frost	•		•	
Flexzone	•		•	
TruPivot hinges	•		•	
DIMENSIONS/WEIGHT				
Width in	35 - 3/8"	(900 mm)	35 - 3/8"	(900 mm)
Height in	83 - 1/2"	(2121 mm)	83 - 1/2"	(2121 mm)
Depth without handle in	25"	(935 mm)	24"	(610 mm)
Minimum niche height in	84"	(2134 mm)	84"	(2134 mm)
Door clearance in	57 - 7/8"	(1470 mm)	57 - 7/8"	(1470 mm)
Door opening angle	105°		105°	
Net Weight	540 lbs	(245 kg)	474 lbs	(215 kg)
POWER / RATINGS (115 V, 60 HZ)				
Watts / Amps	552W - 4.8A		552W - 4.8A	
Power Cable	Nema 5-15P		Nema 5-15P	
INSTRUCTIONS FOR USE				
Use & Care Manual / Installation Manual	English / French / Spanish		English / French / Spanish	

SOFIA

PROFESSIONAL WINE CELLAR
BUILT-IN WINE CELLAR

NEW



NEW



CODE ID	24" PROFESSIONAL WINE CELLAR F7PBW24S1-L (LEFT DOOR) F7PBW24S1-R (RIGHT DOOR)		24" BUILT-IN WINE CELLAR F7IBW24O1-L (LEFT DOOR) F7IBW24O1-R (RIGHT DOOR)	
Series	700		700	
Finish	Professional Design - Stainless Steel		Distinto - Overlay Panel	
PERFORMANCES/CAPACITY				
Noise Level db	41		41	
Riserva Compartment capacity (bottles)	36		36	
Wine Cellar Compartment capacity (bottles)	18		18	
Flexzone Bottom-Drawer capacity (cbft)	2		2	
FEATURES				
Riserva storage compartment				
Natural wood shelves	6		6	
Wine Cellar Compartment				
Natural wood shelves	3		3	
Flexzone Bottom-Drawer				
White Painted Drawers	1		1	
Internal Drawers	1		1	
LED lighting	•		•	
Glass door	•		•	
Equipment				
TriplePlay Refrigeration	•		•	
No Frost	•		•	
Flexzone	•		•	
TruPivot hinges	•		•	
DIMENSIONS/WEIGHT				
Width in	23 - 5/8"	(600 mm)	23 - 5/8"	(600 mm)
Height in	83 - 1/2"	(2121 mm)	83 - 1/2"	(2121 mm)
Depth without handle in	25"	(635 mm)	24"	(610 mm)
Minimum niche height in	84"	(2134 mm)	84"	(2134 mm)
Door clearance in	46"	(1168 mm)	46"	(1168 mm)
Door opening angle	105°		105°	
Net Weight	463 lbs	(210 kg)	386 lbs	(175 kg)
POWER / RATINGS (115 V, 60 HZ)				
Watts / Amps	472W - 4.1A		472W - 4.1A	
Power Cable	Nema 5-15P		Nema 5-15P	
INSTRUCTIONS FOR USE				
Use & Care Manual / Installation Manual	English / French / Spanish		English / French / Spanish	

SOFIA

INTEGRATED DISHWASHER



FULGOR
MILANO

TECHNICAL DATA DISTINTO

CODE ID	24" INTEGRATED DISHWASHER F6PDW24SS1	
Series	600	
Finish	Stainless steel - Interior tub	
PERFORMANCES		
Place Settings	13	
Energy Consumption (kWh / year)	265	
Water Consumption (liters / year)	3360	
Sound level (dB)	50	
HIDDEN CONTROLS		
Program Selector	Grey Push Buttons	
On / Off button	•	
Number of Buttons	4	
Program Gauge	Red	
Temperature	38° - 45° - 55° - 65° - 70°	
Delay Timer	Display 1 digit 9h	
Rinse Aid Level Indicator	Light	
Acoustic Signal at End	•	
PROGRAMMES		
Wash programs	10	
Program	Rapid 27'	Normal (Energy Star)
	Crystal	Extreme wash (Sanitization)
Fast cycles	Daily half load	
	Rinse	Eco quick
	Light quick	Strong and fast
	Normal quick	
ETL Sanitization listed	•	
FEATURES		
Tub Material	Stainless Steel	
Internal Door	Stainless Steel	
Lower Spray Arm	•	
Top Spray Arm	•	
Aquastop	Full	
Keating Element	Concealed heating element	
Turbidness Sensor	•	
Hinges	Fixed Fulcrum - Not Adjustable	
Rear Foot Adjustment	•	
Single Load	4.0 - Pressure switch	
Length of Inlet Hose (mm)	172	
Length of Drain Hose (mm)	170	
Water Hardness Max	100°FH; 58°dH	
BASKETS		
Baskets Color	Grey	
Lower Basket	•	
Upper Basket	•	
Upper Basket Adjustment	Automatic 3 levels	
Cutlery Basket	13 settings	
DIMENSIONS/WEIGHT		
Overall dim - Width	23 - 9/16"	(598 mm)
Overall dim - Height (min - max)	33 - 13/16", 35 - 3/4"	(860 mm) - (910 mm)
Overall dim - Depth	23 - 3/16"	(589 mm)
Cut-out - Width	23 - 5/8"	(600 mm)
Cut-out - Height (min)	33 - 7/8"	(860 mm)
Cut-out - Depth (min - max)	22 - 5/8"	(575 mm)
Gross Weight	101 lbs	(46 kg)
POWER / RATINGS (115 V, 60 HZ)		
kW / Amps rating	1.4 kW - 13A	
Power Cable	Nema 5-15P	
INSTRUCTIONS FOR USE		
Use & Care Manual / Installation Manual	English / French / Spanish	

DISTINTO

TOUCH CONTROL OVEN



CODE ID	30" TOUCH CONTROL SINGLE OVEN F7SP30...	
Series	700	
Finish	...S1 - Stainless Steel ...B1 - Black Glass ...W1 - White Glass	
CONTROL PANEL		
Control Type	Creative Electronic Touch Control	
Display: Clock - Temperature - Function	TFT 3.5"	
Language	English (USA) / English (UK) / French / Spanish / Italian / German	
	Control Interface	Chime Volume Setting
	Full Touch: Functions - Recipes - Settings Menu	Date Format
	Brightness Setting	Demo Mode
OVEN		
Type	Dual True Convection	
Temperature Regulation	Electronic Control (min/max 170/550°F - 75/290°C)	
OVEN FUNCTIONS		
	Pyrolytic Self-Clean	Broil
	True Convection	Dehydrate
	Convection Broil	Thaw (Defrost)
	Convection Roast	Proof (Warm)
	Pizza (Lower Convection)	Keep warm (Warm Plus)
	Bake	Oven Lights
ELECTRIC OVEN FEATURES		
	Preset default temperature	Display instantaneous temperature
	Child Door Lock	Control Display Lock
	Sabbath Mode	12/24 Hour Clock Formats
	Automatic Fast Preheat	Temperature Display °C/°F
	Meat Probe	Event Logs (for Service)
OVEN DOOR(S)		
Oven Glass Window	Large See Through Glass	
Door Cooling System	4 Heat Resistant Glasses	
Door Hinges	Heavy Duty Steady Tilt	
OVEN CAVITY		
Gross Capacity (cbft)	4.4	
Usable Capacity (cbft)	4.1	
Cavity Enamel Colour	Black	
Rack Positions	6	
Oven Lights	3x20W Halogen	
HEATING ELEMENTS (@240V)		
Broil Upper Heating Element	3500 W	
Upper Auxiliary Element	1032 W	
Concealed Bake Lower Heating Element	3000 W	
Convection Element	2 x 1300 W	
OVEN ACCESSORIES		
Chromed Racks	2	
Enameled Broiler Pan (basin + anti splash)	1	
Telescopic Chromed Rack	1	
DIMENSIONS/WEIGHT		
Overall dim - Width	29 - 11/16"	(754 mm)
Overall dim - Height	27 - 7/8"	(707 mm)
Overall dim - Depth	24"	(610 mm)
Cut-out - Width	28 - 7/16"	(722 mm)
Cut-out - Height (min)	27 - 3/8"	(695 mm)
Cut-out - Depth (min)	23 - 1/4"	(590 mm)
Gross Weight	183 lbs	(83 kg)
POWER / RATINGS (208/240 V, 60 HZ)		
kW / Amps rating at 120-240V, 60Hz	3.70kW - 15.4A	
kW / Amps rating at 120-208V, 60Hz	3.50kW - 16.8A	
Power Cable	Conduit	
INSTRUCTIONS FOR USE		
Use & Care Manual / Installation Manual	English / French / Spanish	

DISTINTO

TOUCH CONTROL OVEN



CODE ID	30" TOUCH CONTROL DOUBLE OVEN F7DP30...	
Series	700	
Finish	...S1 - Stainless Steel ...B1 - Black Glass ...W1 - White Glass	
CONTROL PANEL		
Control Type	Creative Electronic Touch Control	
Display: Clock - Temperature - Function	TFT 3.5"	
Language	English (USA) / English (UK) / French / Spanish / Italian / German	
	Control Interface	Chime Volume Setting
	Full Touch: Functions - Recipes - Settings Menu	Date Format
	Brightness Setting	Demo Mode
OVEN		
Type	Dual True Convection	
Temperature Regulation	Electronic Control (min/max 170/550°F - 75/290°C)	
OVEN FUNCTIONS		
	Pyrolytic Self-Clean	Broil
	True Convection	Dehydrate
	Convection Broil	Thaw (Defrost)
	Convection Roast	Proof (Warm)
	Pizza (Lower Convection)	Keep warm (Warm Plus)
	Bake	Oven Lights
ELECTRIC OVEN FEATURES		
	Preset default temperature	Display instantaneous temperature
	Child Door Lock	Control Display Lock
	Sabbath Mode	12/24 Hour Clock Formats
	Automatic Fast Preheat	Temperature Display °C/°F
	Meat Probe (Upper Oven Only)	Event Logs (for Service)
OVEN DOOR(S)		
Oven Glass Window	Large See Through Glass	
Door Cooling System	4 Heat Resistant Glasses	
Door Hinges	Heavy Duty Steady Tilt	
OVEN CAVITY		
Gross Capacity (cbft)	4.4	
Usable Capacity (cbft)	4.1	
Cavity Enamel Colour	Black	
Rack Positions	6	
Oven Lights	3x20W Halogen	
HEATING ELEMENTS (@240V)		
Broil Upper Heating Element	3500 W	
Upper Auxiliary Element	1032 W	
Concealed Bake Lower Heating Element	3000 W	
Convection Element	2 x 1300 W	
OVEN ACCESSORIES		
Chromed Racks	2	
Enameled Broiler Pan (basin + anti splash)	1	
Telescopic Chromed Rack	1	
DIMENSIONS/WEIGHT		
Overall dim - Width	29 - 11/16"	(754 mm)
Overall dim - Height	50 - 13/16"	(1290 mm)
Overall dim - Depth	24"	(610 mm)
Cut-out - Width	28 - 7/16"	(722 mm)
Cut-out - Height (min)	50"	(1270 mm)
Cut-out - Depth (min)	23 - 1/4"	(590 mm)
Gross Weight	326 lbs	(148 kg)
POWER / RATINGS (208/240 V, 60 HZ)		
kW / Amps rating at 120-240V, 60Hz	7.50kW - 31.2A	
kW / Amps rating at 120-208V, 60Hz	6.30kW - 30.3A	
Power Cable	Conduit	
INSTRUCTIONS FOR USE		
Use & Care Manual / Installation Manual	English / French / Spanish	

DISTINTO

OVEN 400



CODE ID	30" OVEN 400 F4SP30S1	
Series	400	
Finish	Stainless Steel	
CONTROL PANEL		
Control Type	Electronic	
Display: Clock - Temperature - Timer	Red LED	
Language	English	
OVEN		
Type	True Convection	
Temperature Regulation	Electronic Control (min/max 120/485°F - 50/250°C)	
OVEN FUNCTIONS		
	Pyrolytic Self-Clean	Bake
	True Convection	Broil
	Convection Bake	Thaw (Defrost)
	Convection Broil	Oven Lights
	Convection Roast	
ELECTRIC OVEN FEATURES		
	Temperature Display °C/°F	
OVEN DOOR(S)		
Oven Glass Window	Large See Through Glass	
Door Cooling System	4 Heat Resistant Glasses	
Door Hinges	Heavy Duty Steady Tilt	
OVEN CAVITY		
Gross Capacity (cbft)	4.4	
Usable Capacity (cbft)	4.1	
Cavity Enamel Colour	Black	
Rack Positions	6	
Oven Lights	3x20W Halogen	
HEATING ELEMENTS (@240V)		
Broil Upper Heating Element	3100 W	
Upper Auxiliary Element	1032 W	
Lower Auxiliary Element	600 W	
Concealed Bake Lower Heating Element	1400 W	
Convection Element	2500 W	
OVEN ACCESSORIES		
Chromed Racks	2	
Enameled Broiler Pan (basin + anti splash)	1	
Telescopic Chromed Rack	Optional	
DIMENSIONS/WEIGHT		
Overall dim - Width	29 - 11/16"	(754 mm)
Overall dim - Height	27 - 7/8"	(707 mm)
Overall dim - Depth	24"	(610 mm)
Cut-out - Width	28 - 7/16"	(722 mm)
Cut-out - Height (min)	27 - 1/4"	(692 mm)
Cut-out - Depth (min)	23 - 1/4"	(590 mm)
Gross Weight	181 lbs	(82 kg)
POWER / RATINGS (208/240 V, 60 HZ)		
kW / Amps rating at 120-240V, 60Hz	3.70kW - 16.1A	
kW / Amps rating at 120-208V, 60Hz	3.49kW - 17.1A	
Power Cable	Conduit	
INSTRUCTIONS FOR USE		
Use & Care Manual / Installation Manual	English / French / Spanish	

DISTINTO

WARMING DRAWER



CODE ID	30" WARMING DRAWER F7DWD30S1		30" WARMING DRAWER F7IWD30O1	
Type	Warming Drawer		Warming Drawer	
Front finish	Stainless Steel		Overlay	
Internal shelf	Inox		Inox	
Compatible with ovens	F75P30S1 - F7DP30S1 - F4SP30S1		F75P30S1 - F7DP30S1 - F4SP30S1	
PERFORMANCE				
Maximum temperature	194°F / 90°C		194°F / 90°C	
Cooking at low temperature (slow cooking)	•		•	
Leavening	•		•	
Heating dishes and food	•		•	
Slow close assistance	-		-	
Open / Close push - pull system	•		•	
CONTROL				
Thermostat	86°F - 194°F / 30°C - 90°C		86°F - 194°F / 30°C - 90°C	
Fan assisted	•		•	
Function Indicator / Thermostat on/off	•		•	
SAFETY				
Safety front	•		•	
ELECTRICAL SPECIFICATIONS				
Max power absorbed (W)	1500W		1500W	
Power (V-Hz)	120/60		120/60	
Power cord	•		•	
Plug	•		•	
CAPACITY				
Volume (cbft-litri)	2,1	61.4	2,1	61.4
DIMENSIONS				
Overall dim - Width	29 - 11/16"	(754 mm)	29 7/8"	(758 mm)
Overall dim - Height	10 3/8"	(264 mm)	10 3/8"	(264 mm)
Overall dim - Depth	22 3/4"	(578 mm)	22 3/4"	(578 mm)
Door Depth with Overlay	15/16"	(24 mm)	7/8"	(22 mm)
Cut-out - Width	28 5/8"	(727 mm)	28 5/8"	(727 mm)
Cut-out - Height	9 1/8"	(235 mm)	9 1/8"	(235 mm)
Cut-out - Depth	24"	(610 mm)	24"	(610 mm)
WEIGHT				
Net Weight	67 lbs	30.1 Kg	62 lbs	28.1 Kg
Gross Weight	73 lbs	33.2 Kg	69 lbs	31.2 Kg

DISTINTO

MULTIFUNCTION SELF-CLEAN OVEN



CODE ID	30" MULTIFUNCTION SELF-CLEAN OVEN F1SP30S1		24" MULTIFUNCTION SELF-CLEAN OVEN F1SP24S2	
Series	100		100	
Finish	Stainless Steel		Stainless Steel	
CONTROL PANEL				
Control Type	Electronic		Electronic	
Display: Clock - Timer - Temperature	Red LED		Red LED	
Language	English		English	
OVEN				
Type	Electronic		Electronic	
Temperature Regulation	Electronic Control (min/max 120/485°F - 50/250°C)		Electronic Control (min/max 120/485°F - 50/250°C)	
OVEN FUNCTIONS				
	Pyrolytic Self-Clean	Bake	Pyrolytic Self-Clean	Bake
	True Convection	Thaw (Defrost)	True Convection	Thaw (Defrost)
	Convection Bake	Oven Lights	Convection Bake	Oven Lights
	Convection Broil	Broil	Convection Broil	Broil
	Convection Roast		Convection Roast	
GAS OVEN FEATURES				
	Temperature Display °C/°F		Temperature Display °C/°F	
OVEN DOOR(S)				
Oven Glass Window	Large See Through Glass		Large See Through Glass	
Door Cooling System	4 Heat Resistant Glasses		4 Heat Resistant Glasses	
Door Hinges	Heavy Duty Steady Tilt		Heavy Duty Steady Tilt	
Handle Style	Tubular Steel		Tubular Steel	
OVEN CAVITY				
Gross Capacity (cbft)	3.0		2.6	
Usable Capacity (cbft)	2.8		2.4	
Cavity Enamel Colour	Black		Black	
Rack Positions	4		5	
Oven Lights	2x20W Halogen		1x20W Halogen	
HEATING ELEMENTS (@240V)				
Broil Upper Heating Element	3100 W		1200 W	
Upper Auxiliary Element	1032 W		1000 W	
Lower Auxiliary Element	600 W		-	
Concealed Bake Lower Heating Element	1400 W		1100 W	
Convection Element	2500 W		2300 W	
OVEN ACCESSORIES				
Chromed Racks	2		2	
Enameled Broiler Pan (basin + anti splash)	1		1	
Telescopic Chromed Rack	Optional		Optional	
DIMENSIONS/WEIGHT				
Overall dim - Width	29 - 3/8"	(745 mm)	23 - 3/8"	(594 mm)
Overall dim - Height	23 - 3/16"	(589 mm)	23 - 3/8"	(594 mm)
Overall dim - Depth	22 - 1/16"	(560 mm)	21 - 7/8"	(556 mm)
Cut-out - Width	28"	(710 mm)	22 - 1/16"	(560 mm)
Cut-out - Height (min)	23"	(585 mm)	23"	(585 mm)
Cut-out - Depth (min)	24"	(610 mm)	22 - 1/16"	(560 mm)
Gross Weight	148 lbs	(67 kg)	90 lbs	(41 kg)
POWER / RATINGS (208/240 V, 60 HZ)				
kW / Amps rating at 120-240V, 60Hz	3.63kW - 15.6A		3.35kW - 13.9A	
kW / Amps rating at 120-208V, 60Hz	3.53kW - 17.4A		2.55kW - 12.3A	
Power Cable	Conduit		Conduit	
INSTRUCTIONS FOR USE				
Use & Care Manual / Installation Manual	English / French / Spanish		English / French / Spanish	

DISTINTO

MULTIFUNCTION EASY-CLEAN OVEN



CODE ID	30" MULTIFUNCTION EASY-CLEAN OVEN F1SM30S1		24" MULTIFUNCTION EASY-CLEAN OVEN F1SM24S2	
Series	100		100	
Finish	Stainless Steel		Stainless Steel	
CONTROL PANEL				
Control Type	2 Knobs/6 Buttons		2 Knobs/3 Buttons	
Display: Clock - Timer	Red LED		Red LED	
OVEN				
Type	Electronic		Electronic	
Temperature Regulation	Electro-Mechanical Control (min/max 120/540°F - 50/285°C)		Electro-Mechanical Control (min/max 120/480°F - 50/250°C)	
OVEN FUNCTIONS				
	Convection Bake	Thaw (Defrost)	True Convection	Bake
	Convection Broil	Lower Bake	Convection Bake	Oven Lights
	Convection Roast	Oven Lights	Convection Broil	Broil
	Pizza (Lower Convection)	Broil	Convection Roast	
	Bake			
OVEN DOOR(S)				
Oven Glass Window	Large See Through Glass		Large See Through Glass	
Door Cooling System	3 Heat Resistant Glasses		3 Heat Resistant Glasses	
Door Hinges	Heavy Duty Steady Tilt		Heavy Duty Steady Tilt	
Handle Style	Tubular Steel		Tubular Steel	
OVEN CAVITY				
Gross Capacity (cbft)	3.0		2.6	
Usable Capacity (cbft)	2.8		2.4	
Cavity Enamel Colour	Black		Black	
Rack Positions	4		5	
Oven Lights	2x20W Halogen		1x20W Halogen	
HEATING ELEMENTS (@240V)				
Broil Upper Heating Element	3100 W		1200 W	
Upper Auxiliary Element	1032 W		1000 W	
Lower Auxiliary Element	-		-	
Concealed Bake Lower Heating Element	2100 W		1100 W	
Convection Element	-		2300 W	
OVEN ACCESSORIES				
Chromed Racks	2		2	
Enameled Broiler Pan (basin + anti splash)	1 (basin only)		1	
Telescopic Chromed Rack	-		Optional	
DIMENSIONS/WEIGHT				
Overall dim - Width	29 - 3/8"	(745 mm)	23 - 3/8"	(594 mm)
Overall dim - Height	23 - 3/16"	(589 mm)	23 - 3/8"	(594 mm)
Overall dim - Depth	22 - 1/16"	(560 mm)	21 - 7/8"	(556 mm)
Cut-out - Width	28"	(710 mm)	22 - 1/16"	(560 mm)
Cut-out - Height (min)	23"	(585 mm)	23"	(585 mm)
Cut-out - Depth (min)	24"	(610 mm)	22 - 1/16"	(560 mm)
Gross Weight	148 lbs	(67 kg)	90 lbs	(41 kg)
POWER / RATINGS (208/240 V, 60 HZ)				
kW / Amps rating at 120-240V, 60Hz	3.63kW - 15.6A		2.35kW - 9.8A	
kW / Amps rating at 120-208V, 60Hz	2.76kW - 13.7A		1.80kW - 8.6A	
Power Cable	Conduit		Conduit	
INSTRUCTIONS FOR USE				
Use & Care Manual / Installation Manual	English / French / Spanish		English / French / Spanish	

DISTINTO

GAS COOKTOP



CODE ID	44" GAS COOKTOP F4GK42S1		36" GAS COOKTOP F4GK36S1	
Series	400		400	
Finish	Stainless Steel		Stainless Steel	
CONTROL PANEL				
Control Type	Knobs		Knobs	
COOKTOP				
Type	GAS (NG or LP)		GAS (NG or LP)	
Cooking Surface	Matte Black Enamel		Matte Black Enamel	
GAS COOKTOP FEATURES				
Electric Re-ignition system	•		•	
Flame-out sensing	•		•	
Dual Flame Burner	•		•	
Simmer Plate	Optional		Optional	
Small Pot Insert (for single burners only)	Optional		Optional	
Wok Ring (for dual burner only)	Optional		Optional	
Heavy Duty Cast Iron Grates	4		3	
Cooking Zones	4		5	
Burners types	Sealed Burners (all) - Dual Flame/Simmer Burner (only Left)		Sealed Burners (all) - Dual Flame/Simmer Burner (only Center)	
Power (Max/Min) (Left)	18000 (BTU/h) - 5275W / 700 (BTU/h) - 205W		-	
Power (Max/Min) (Front-L)	-		6300 (BTU/h) - 1850W / 1300 (BTU/h) - 380W	
Power (Max/Min) (Rear-L)	-		9000 (BTU/h) - 2640W / 1300 (BTU/h) - 380W	
Power (Max/Min) (L Center)	4000 (BTU/h) - 1175W / 1000 (BTU/h) - 295W		-	
Power (Max/Min) (Front Center)	-		18000 (BTU/h) - 5275W / 700 (BTU/h) - 205W	
Power (Max/Min) (R Center)	9000 (BTU/h) - 2640W / 1300 (BTU/h) - 380W		-	
Power (Max/Min) (Front-R)	-		4000 (BTU/h) - 1175W / 1000 (BTU/h) - 295W	
Power (Max/Min) (Rear-R)	-		12000 (BTU/h) - 3520W / 2200 (BTU/h) - 645W	
Power (Max/Min) (Right)	15000 (BTU/h) - 4400W / 2700 (BTU/h) - 790W		-	
DIMENSIONS/WEIGHT				
Overall dim - Width	44"	(1120 mm)	36"	(910 mm)
Overall dim - Height	5 - 3/16"	(132 mm)	5 - 3/16"	(132 mm)
Overall dim - Depth	16 - 3/4"	(425 mm)	20 - 1/16"	(510 mm)
Cut-out - Width	43 - 1/8", 43 - 1/4"	(1096 mm) - (1099 mm)	34 - 7/8", 35"	(886 mm) - (889 mm)
Cut-out - Height (min)	3 - 15/16"	(74 mm)	3 - 15/16"	(74 mm)
Cut-out - Depth (min - max)	15 - 15/16", 16 - 1/16"	(405 mm) - (408 mm)	19 - 5/16", 19 - 3/8"	(490 mm) - (493 mm)
Gross Weight	45 lbs	(20 kg)	55 lbs	(25 kg)
POWER / RATINGS (120 V, 60 HZ)				
Amps	0.1A		0.1A	
Max Power	46000 (BTU/h) - 13475W		52300 (BTU/h) - 15320W	
Power Cable	Nema 5-15P		Nema 5-15P	
INSTRUCTIONS FOR USE				
Use & Care Manual / Installation Manual	English / French / Spanish		English / French / Spanish	

DISTINTO

GAS COOKTOP



CODE ID	30" GAS COOKTOP F4GK30S1		24" GAS COOKTOP F4GK24S1	
Series	400		400	
Finish	Stainless Steel		Stainless Steel	
CONTROL PANEL				
Control Type	Knobs		Knobs	
COOKTOP				
Type	GAS (NG or LP)		GAS (NG or LP)	
Cooking Surface	Matte Black Enamel		Matte Black Enamel	
GAS COOKTOP FEATURES				
Electric Re-ignition system	•		•	
Flame-out sensing	•		•	
Dual Flame Burner	•		•	
Simmer Plate	Optional		Optional	
Small Pot Insert (for single burners only)	Optional		Optional	
Wok Ring (for dual burner only)	Optional		-	
Heavy Duty Cast Iron Grates	2		4	
Cooking Zones	5		4	
Burners types	Sealed Burners (all) - Dual Flame/Simmer Burner (only Left)		Sealed Burners (all) - Dual Flame/Simmer Burner (only Front-L)	
Power (Max/Min) (Left)	18000 (BTU/h) - 5275W / 700 (BTU/h) - 205W		-	
Power (Max/Min) (Front-L)	-		18000 (BTU/h) - 5275W / 700 (BTU/h) - 205W	
Power (Max/Min) (Rear-L)	-		6300 (BTU/h) - 1850W / 1300 (BTU/h) - 380W	
Power (Max/Min) (Front Center)	4000 (BTU/h) - 1175W / 1000 (BTU/h) - 295W		-	
Power (Max/Min) (Rear Center)	12000 (BTU/h) - 3520W / 2200 (BTU/h) - 645W		-	
Power (Max/Min) (Front-R)	6300 (BTU/h) - 1850W / 1300 (BTU/h) - 380W		4000 (BTU/h) - 1175W / 1000 (BTU/h) - 295W	
Power (Max/Min) (Rear-R)	9000 (BTU/h) - 2640W / 1300 (BTU/h) - 380W		12000 (BTU/h) - 3520W / 2200 (BTU/h) - 645W	
DIMENSIONS/WEIGHT				
Overall dim - Width	30"	(760 mm)	24 - 1/2"	(620 mm)
Overall dim - Height	5 - 3/16"	(132 mm)	5 - 3/16"	(132 mm)
Overall dim - Depth	20 - 1/16"	(510 mm)	20 - 1/16"	(510 mm)
Cut-out - Width	29", 29 - 1/8"	(737 mm) - (740 mm)	23 - 1/2", 23 - 5/8"	(597 mm) - (600 mm)
Cut-out - Height (min)	3 - 15/16"	(74 mm)	3 - 15/16"	(74 mm)
Cut-out - Depth (min - max)	19 - 5/16", 19 - 3/8"	(490 mm) - (493 mm)	19 - 5/16", 19 - 3/8"	(490 mm) - (493 mm)
Gross Weight	45 lbs	(20 kg)	41 lbs	(19 kg)
POWER / RATINGS (120 V, 60 HZ)				
Amps	0.1A		0.1A	
Max Power	49300 (BTU/h) - 14440W		40300 (BTU/h) - 11800W	
Power Cable	Nema 5-15P		Nema 5-15P	
INSTRUCTIONS FOR USE				
Use & Care Manual / Installation Manual	English / French / Spanish		English / French / Spanish	

DISTINTO

INDUCTION COOKTOP WITH
BRUSHED ALUMINUM TRIM



CODE ID	36" INDUCTION COOKTOP WITH BRUSHED ALUMINUM TRIM F7IT36S1		
Series	700		
Finish	Ceramic glass with aluminum frame		
CONTROL PANEL			
Control Type	Touch Control		
COOKTOP			
Type	INDUCTION		
Cooking Surface	Ceramic Glass		
Slider Touch Control for Power Setting	•		
Digital Display for Power Level	•		
INDUCTION COOKTOP FEATURES			
Pot Detection System	•		
Bridge double zone	•		
Power Levels	1 to 9		
Warming Function 158°F / 70°C	•		
Booster/Fast Boil Function for Each Zone	•		
Auto-boil and Reduce for Each Zone	•		
Residual Heat Indication	•		
Individual Timer for each Zone	•		
Child Lock	•		
Key Lock (LED)	•		
Pause/recall (LED)	•		
General ON/OFF Key (LED)	•		
Cooking Zones	5		
Burners types (Front-L) - Power (Max/Booster)	Inductor	11" (280 mm)	2300W / 3600W
Burners types (Rear Central) - Power (Max/Booster)	Inductor	7" (180 mm)	1850W / 3000W
Burners types (Front Central) - Power (Max/Booster)	Inductor	5 - 3/4" (145 mm)	1400W / 2200W
Burners types (Rear/Front-R) - Power (Max/Booster)	(Octagonal) Inductor	7 - 1/2" x 8 - 1/2" (190 mm x 220 mm)	2000W / 3600W
DIMENSIONS/WEIGHT			
Overall dim - Width	36 - 3/16"	(919 mm)	
Overall dim - Height	4"	(100 mm)	
Overall dim - Depth	21 - 3/16"	(538 mm)	
Cut-out - Width (Tolerance)	34 - 5/8" tol. 1/16"	(879 mm) - (tol. 1 mm)	
Cut-out - Height	2 - 5/8" + conduit 1 - 1/16"	(67 mm) + conduit (27 mm)	
Cut-out - Depth (Tolerance)	19 - 3/8" tol. 1/16"	(492 mm) - (tol. 1 mm)	
Gross Weight	55 lbs	(25 kg)	
POWER / RATINGS (208/240 V, 60 HZ)			
kW / Amps rating at 240V, 60Hz	10.8 kW - 45A		
kW / Amps rating at 208V, 60Hz	9.4 kW - 45A		
Power Cable	Conduit		
INSTRUCTIONS FOR USE			
Use & Care Manual / Installation Manual	English / French / Spanish		

DISTINTO

INDUCTION COOKTOP WITH
BRUSHED ALUMINUM TRIM



CODE ID	30" INDUCTION COOKTOP WITH BRUSHED ALUMINUM TRIM F7IT30S1		
Series	700		
Finish	Ceramic glass with aluminum frame		
CONTROL PANEL			
Control Type	Touch Control		
COOKTOP			
Type	INDUCTION		
Cooking Surface	Ceramic Glass		
Slider Touch Control for Power Setting	•		
Digital Display for Power Level	•		
INDUCTION COOKTOP FEATURES			
Pot Detection System	•		
Power Levels	1 to 9		
Warming Function 158°F / 70°C	•		
Booster/Fast Boil Function for Each Zone	•		
Auto-boil and Reduce for Each Zone	•		
Residual Heat Indication	•		
Individual Timer for each Zone	•		
Child Lock	•		
Key Lock (LED)	•		
Pause/recall (LED)	•		
General ON/OFF Key (LED)	•		
Cooking Zones	4		
Burners types (Front-L) - Power (Max/Booster)	Inductor	11" (280 mm)	2300W / 3600W
Burners types (Rear Central) - Power (Max/Booster)	Inductor	7" (180 mm)	1850W / 3000W
Burners types (Rear-R) - Power (Max/Booster)	Inductor	5 - 3/4" (145 mm)	1400W / 2200W
Burners types (Front-R) - Power (Max/Booster)	Inductor	7" (180 mm)	1850W / 3000W
DIMENSIONS/WEIGHT			
Overall dim - Width	30 - 3/8"	(771 mm)	
Overall dim - Height	4"	(100 mm)	
Overall dim - Depth	21 - 3/16"	(538 mm)	
Cut-out - Width (Tolerance)	28 - 3/4" tol. 1/16"	(730 mm) - (tol. 1 mm)	
Cut-out - Height	2 - 5/8" + conduit 1 - 1/16"	(67 mm) + conduit (27 mm)	
Cut-out - Depth (Tolerance)	19 - 7/16" tol. 1/16"	(494 mm) - (tol. 1 mm)	
Gross Weight	40 lbs	(18 kg)	
POWER / RATINGS (208/240 V, 60 HZ)			
kW / Amps rating at 240V, 60Hz	7.2 kW - 30A		
kW / Amps rating at 208V, 60Hz	6.45 kW - 31A		
Power Cable	Conduit		
INSTRUCTIONS FOR USE			
Use & Care Manual / Installation Manual	English / French / Spanish		

DISTINTO

RADIANT COOKTOP WITH TOUCH
CONTROL WITH BRUSHED ALUMINUM TRIM



CODE ID	36" RADIANT COOKTOP WITH TOUCH CONTROL WITH BRUSHED ALUMINUM TRIM F6RT36S2		
Series	600		
Finish	Ceramic glass with aluminum frame		
CONTROL PANEL			
Control Type	Touch Control		
COOKTOP			
Type	RADIANT		
Cooking Surface	Ceramic Glass		
RADIANT COOKTOP FEATURES			
Power Setting	Peacock Slider Touch Control		
Digital Display for Power Level	5		
Low Power Scale for Delicate Cooking	•		
Control Display Lock	•		
Automatic Fast Boil Function	•		
Hot Surface Indication	•		
Timer Functions	1+5		
Timer Display	•		
Acoustic Buzzer	•		
Failure Codes Indication	•		
Cooking Zones	5		
Burners types (Front/Rear-L) - Power	7"	(180 mm)	1800W
Bridge Element - Power			800W
Burners types (Central) - Power	9" / 7" / 5"	(230 mm / 180 mm / 127 mm)	2500W / 1600W / 800W
Burners types (Rear-R) - Power	7"	(180 mm)	1800W
Burners types (Front-R) - Power	6"	(153 mm)	1200W
DIMENSIONS/WEIGHT			
Overall dim - Width	36 - 3/16"	(919 mm)	
Overall dim - Height	3 - 5/16" + conduit 15/16"	(84 mm) + conduit (24 mm)	
Overall dim - Depth	21 - 3/16"	(538 mm)	
Cut-out - Width (min - max)	34 - 1/16", 34 - 5/16"	(865 mm) - (872 mm)	
Box - Height	3 - 1/16" + conduit 15/16"	(78 mm) + conduit (24 mm)	
Cut-out - Depth (min - max)	19 - 1/4", 19 - 5/8"	(490 mm) - (498 mm)	
Gross Weight	44 lbs	(20 kg)	
POWER / RATINGS (208/240 V, 60 HZ)			
kW / Amps rating at 240V, 60Hz	9.90kW - 41.3A		
kW / Amps rating at 208V, 60Hz	7.44kW - 35.8A		
Power Cable	Conduit		
INSTRUCTIONS FOR USE			
Use & Care Manual / Installation Manual	English / French / Spanish		

DISTINTO

RADIANT COOKTOP WITH TOUCH
CONTROL WITH BRUSHED ALUMINUM TRIM



CODE ID	30" RADIANT COOKTOP WITH TOUCH CONTROL WITH BRUSHED ALUMINUM TRIM F6RT30S2		
Series	600		
Finish	Ceramic glass with aluminum frame		
CONTROL PANEL			
Control Type	Touch Control		
COOKTOP			
Type	RADIANT		
Cooking Surface	Ceramic Glass		
RADIANT COOKTOP FEATURES			
Power Setting	Peacock Slider Touch Control		
Digital Display for Power Level	4		
Low Power Scale for Delicate Cooking	•		
Control Display Lock	•		
Automatic Fast Boil Function	•		
Hot Surface Indication	•		
Timer Functions	1+4		
Timer Display	•		
Acoustic Buzzer	•		
Failure Codes Indication	•		
Cooking Zones	4		
Burners types (Front-L) - Power	6"	(153 mm)	1200W
Burners types (Rear-L) - Power	9" / 7" / 5"	(230 mm / 180 mm / 127 mm)	2500W / 1600W / 800W
Burners types (Rear-R) - Power	8" / 5"	(203 mm / 127 mm)	2200W / 800W
Burners types (Front-R) - Power	6"	(153 mm)	1200W
DIMENSIONS/WEIGHT			
Overall dim - Width	30 - 3/8"	(771 mm)	
Overall dim - Height	3 - 5/16" + conduit 15/16"	(84 mm) + conduit (24 mm)	
Overall dim - Depth	21 - 3/16"	(538 mm)	
Cut-out - Width (min - max)	28 - 11/16", 28 - 15/16"	(729 mm) - (735 mm)	
Box - Height	3 - 1/16" + conduit 15/16"	(78 mm) + conduit (24 mm)	
Cut-out - Depth (min - max)	19 - 1/4", 19 - 5/8"	(490 mm) - (498 mm)	
Gross Weight	36 lbs	(16 kg)	
POWER / RATINGS (208/240 V, 60 HZ)			
kW / Amps rating at 240V, 60Hz	7.10kW - 29.6A		
kW / Amps rating at 208V, 60Hz	5.33kW - 25.6A		
Power Cable	Conduit		
INSTRUCTIONS FOR USE			
Use & Care Manual / Installation Manual	English / French / Spanish		

DISTINTO

RADIANT COOKTOP WITH KNOB CONTROL WITH BRUSHED ALUMINUM TRIM



CODE ID	24" RADIANT COOKTOP WITH KNOB CONTROL WITH BRUSHED ALUMINUM TRIM F3RK24S2		
Series	300		
Finish	Ceramic glass with aluminum frame		
CONTROL PANEL			
Control Type	Knobs		
COOKTOP			
Type	RADIANT		
Cooking Surface	Ceramic Glass		
RADIANT COOKTOP FEATURES			
Power Setting	9 Levels		
Digital Display for Power Level	-		
Hot Surface Indication	•		
Cooking Zones	4		
Burners types (Front-L) - Power	7 - 3/4" / 4 - 3/4"	(197 mm / 121 mm)	1900W / 800W
Burners types (Rear-R) - Power	5 - 1/2"	(140 mm)	1200W
Burners types (Front-R - Rear-L) - Power	7"	(180 mm)	1800W
DIMENSIONS/WEIGHT			
Overall dim - Width	24"	(618 mm)	
Overall dim - Height	3 - 5/16" + conduit 15/16"	(84 mm) + conduit (24 mm)	
Overall dim - Depth	21 - 3/16"	(538 mm)	
Cut-out - Width (min - max)	22 - 5/8", 22 - 13/16"	(574 mm) - (580 mm)	
Box - Height	3 - 1/16" + conduit 15/16"	(78 mm) + conduit (24 mm)	
Cut-out - Depth (min - max)	19 - 1/4", 19 - 9/16"	(490 mm) - (497 mm)	
Gross Weight	30 lbs	(14 kg)	
POWER / RATINGS (208/240 V, 60 HZ)			
kW / Amps rating at 240V, 60Hz	6.10kW - 25.4A		
kW / Amps rating at 208V, 60Hz	4.58kW - 22.0A		
Power Cable	Conduit		
INSTRUCTIONS FOR USE			
Use & Care Manual / Installation Manual	English / French / Spanish		

DISTINTO

INSERT HOOD



CODE ID	34" INSERT HOOD F6BP34S1		28" INSERT HOOD F4BP28S1	
Series	600		400	
Finish	Insert - Stainless Steel		Insert - Stainless Steel	
CONTROL PANEL				
Control Type	4 speed mechanical control		4 speed mechanical control	
PERFORMANCES				
Output (CFM)	600		600	
Sound Level (dB)	69		69	
Motor	One		One	
Venting Type	Ducted and recirculating		Ducted and recirculating	
FEATURES				
Filter Style	Pro Baffle		Baffle	
Lighting	2 x 1.2W LED		2 x 1.2W LED	
Duct diameter	5 - 15/16"	(150 mm)	5 - 15/16"	(150 mm)
DIMENSIONS/WEIGHT				
Overall dim - Width	34 - 1/4"	(870 mm)	28 - 3/8"	(720 mm)
Overall dim - Height	13 - 1/8"	(330 mm)	10 - 5/8"	(270 mm)
Overall dim - Depth	18 - 1/2"	(470 mm)	15 - 3/4"	(400 mm)
Cut-out (w x d)	32 - 1/16" x 16 - 1/2"	(814 mm x 419 mm)	26 - 1/8" x 14 - 1/4"	(664 mm x 362 mm)
Gross Weight	51 lbs	(23 kg)	33 lbs	(15 kg)
POWER / RATINGS (115 V, 60 HZ)				
Watts / Amps	430W - 3.8A		430W - 3.8A	
Power Cable	Nema 5-15P		Nema 5-15P	
INSTRUCTIONS FOR USE				
Use & Care Manual / Installation Manual	English / French / Spanish		English / French / Spanish	

DISTINTO

UNDERCABINET HOOD



CODE ID	36" UNDERCABINET HOOD F4UC36S1		30" UNDERCABINET HOOD F4UC30S1	
Series	400		400	
Finish	Undercabinet - Stainless Steel		Undercabinet - Stainless Steel	
CONTROL PANEL				
Control Type	4 speed pushbutton control		4 speed pushbutton control	
PERFORMANCES				
Output (CFM)	450		450	
Sound Level (dB)	69		69	
Motor	One		One	
Venting Type	Ducted and recirculating		Ducted and recirculating	
FEATURES				
Filter Style	Baffle		Baffle	
Lighting	2 x 1.2W LED		2 x 1.2W LED	
Duct diameter	5 - 15/16"	(150 mm)	5 - 15/16"	(150 mm)
DIMENSIONS/WEIGHT				
Overall dim - Width	35 - 7/8"	(910 mm)	29 - 13/16"	(760 mm)
Overall dim - Height	10 - 1/4"	(260 mm)	18"	(460 mm)
Overall dim - Depth	21 - 1/8"	(535 mm)	24"	(610 mm)
Gross Weight	46 lbs	(21 kg)	61 lbs	(28 kg)
POWER / RATINGS (115 V, 60 HZ)				
Watts / Amps	430W - 3.8A		430W - 3.8A	
Power Cable	Nema 5-15P		Nema 5-15P	
INSTRUCTIONS FOR USE				
Use & Care Manual / Installation Manual	English / French / Spanish		English / French / Spanish	

NEW

DISTINTO

BUILT-IN FRIDGE



CODE ID	36" BUILT-IN FRIDGE F71BM36O1-L (LEFT DOOR) F71BM36O1-R (RIGHT DOOR)	
Series	700	
Finish	Distinto - Overlay Panel	
PERFORMANCES/CAPACITY		
Annual Energy Usage	\$70 (580 kWh)	
Noise Level db	40	
Fridge compartment capacity (cbft)	14.7	
Flexzone Bottom-Drawer capacity (cbft)	3.8	
FEATURES		
Fridge Compartment		
Glass Shelves	2	
Adjustable Door Shelves	3	
Micro shot-peened Stainless Steel Drawers	2 Low Temp	
Flexzone Bottom-Drawer		
White Painted Drawers	1	
Internal Drawers	1 + 1 ice tray	
LED lighting	•	
Ice Maker	•	
Equipment		
No Frost	•	
Flexzone	•	
TruPivot hinges	•	
DIMENSIONS/WEIGHT		
Width in	35 - 3/8"	(900 mm)
Height in	83 - 1/2"	(2121 mm)
Depth without handle in	24"	(610 mm)
Minimum niche height in	84"	(2134 mm)
Door clearance in	57 - 7/8"	(1470 mm)
Door opening angle	105°	
Net Weight	474 lbs	(215 kg)
POWER / RATINGS (115 V, 60 HZ)		
Watts / Amps	552W - 4.8A	
Power Cable	Nema 5-15P	
INSTRUCTIONS FOR USE		
Use & Care Manual / Installation Manual	English / French / Spanish	

DISTINTO

BUILT-IN WINE CELLAR

NEW



CODE ID	24" BUILT-IN WINE CELLAR F71BW24O1-L (LEFT DOOR) F71BW24O1-R (RIGHT DOOR)	
Series	700	
Finish	Distinto - Overlay Panel	
PERFORMANCES/CAPACITY		
Noise Level db	41	
Riserva Compartment capacity (bottles)	36	
Wine Cellar Compartment capacity (bottles)	18	
Flexzone Bottom-Drawer capacity (cbft)	2	
FEATURES		
Riserva storage compartment		
Natural wood shelves	6	
Wine Cellar Compartment		
Natural wood shelves	3	
Flexzone Bottom-Drawer		
White Painted Drawers	1	
Internal Drawers	1	
LED lighting	•	
Glass door	•	
Equipment		
TriplePlay Refrigeration	•	
No Frost	•	
Flexzone	•	
TruPivot hinges	•	
DIMENSIONS/WEIGHT		
Width in	23 - 5/8"	600 mm)
Height in	83 - 1/2"	(2121 mm)
Depth without handle in	24"	(610 mm)
Minimum niche height in	84"	(2134 mm)
Door clearance in	46"	(1168 mm)
Door opening angle	105°	
Net Weight	386 lbs	(175 kg)
POWER / RATINGS (115 V, 60 HZ)		
Watts / Amps	472W - 4.1A	
Power Cable	Nema 5-15P	
INSTRUCTIONS FOR USE		
Use & Care Manual / Installation Manual	English / French / Spanish	

DISTINTO

INTEGRATED DISHWASHER



CODE ID	24" INTEGRATED DISHWASHER WITH STAINLESS STEEL EXTERIOR F6DW24SS1	
Series	600	
Finish	Fully Integrated - Stainless Steel	
PERFORMANCES		
Place Settings	13	
Energy Consumption (kWh / year)	265	
Water Consumption (liters / year)	3360	
Sound level (dB)	50	
HIDDEN CONTROLS		
Program Selector	Grey Push Buttons	
On / Off button	•	
Number of Buttons	4	
Program Gauge	Red	
Temperature	38° - 45° - 55° - 65° - 70°	
Delay Timer	Display 1 digit 9h	
Rinse Aid Level Indicator	Light	
Acoustic Signal at End	•	
PROGRAMMES		
Wash programs	10	
Program	Rapid 27'	Normal (Energy Star)
	Crystal	Extreme wash (Sanitization)
	Daily half load	
Fast cycles	Rinse	Eco quick
	Light quick	Strong and fast
	Normal quick	
ETL Sanitization listed	•	
FEATURES		
Tub Material	Stainless Steel	
Internal Door	Stainless Steel	
Lower Spray Arm	•	
Top Spray Arm	•	
Aquastop	Full	
Keating Element	Concealed heating element	
Turbidness Sensor	•	
Hinges	Fixed Fulcrum - Not Adjustable	
Rear Foot Adjustment	•	
Single Load	4.0 - Pressure switch	
Length of Inlet Hose (mm)	172	
Length of Drain Hose (mm)	170	
Water Hardness Max	100°FH; 58°dH	
BASKETS		
Baskets Color	Grey	
Lower Basket	•	
Upper Basket	•	
Upper Basket Adjustment	Automatic 3 levels	
Cutlery Basket	13 settings	
DIMENSIONS/WEIGHT		
Overall dim - Width	23 - 9/16"	(598 mm)
Overall dim - Height (min - max)	33 - 13/16", 35 - 3/4"	(860 mm) - (910 mm)
Overall dim - Depth	23 - 3/16"	(589 mm)
Cut-out - Width	23 - 5/8"	(600 mm)
Cut-out - Height (min)	33 - 7/8"	(860 mm)
Cut-out - Depth (min - max)	22 - 5/8"	(575 mm)
Gross Weight	101 lbs	(46 kg)
POWER / RATINGS (115 V, 60 HZ)		
kW / Amps rating	1.4 kW - 13A	
Power Cable	Nema 5-15P	
INSTRUCTIONS FOR USE		
Use & Care Manual / Installation Manual	English / French / Spanish	

DISTINTO

INTEGRATED DISHWASHER



CODE ID	24" FULLY INTEGRATED DISHWASHER F6DW24F11	
Series	600	
Finish	Fully Integrated - Panel Ready	
PERFORMANCES		
Place Settings	13	
Energy Consumption (kWh / year)	265	
Water Consumption (liters / year)	3360	
Sound level (dB)	50	
HIDDEN CONTROLS		
Program Selector	Grey Push Buttons	
On / Off button	•	
Number of Buttons	4	
Program Gauge	Red	
Temperature	38° - 45° - 55° - 65° - 70°	
Delay Timer	Display 1 digit 9h	
Rinse Aid Level Indicator	Light	
Acoustic Signal at End	•	
PROGRAMMES		
Wash programs	10	
Program	Rapid 27'	Normal (Energy Star)
	Crystal	Extreme wash (Sanitization)
	Daily half load	
Fast cycles	Rinse	Eco quick
	Light quick	Strong and fast
	Normal quick	
ETL Sanitization listed	•	
FEATURES		
Tub Material	Stainless Steel	
Internal Door	Stainless Steel	
Lower Spray Arm	•	
Top Spray Arm	•	
Aquastop	Full	
Keating Element	Concealed heating element	
Turbidness Sensor	•	
Hinges	Fixed Fulcrum - Not Adjustable	
Rear Foot Adjustment	•	
Single Load	4.0 - Pressure switch	
Length of Inlet Hose (mm)	172	
Length of Drain Hose (mm)	170	
Water Hardness Max	100°FH; 58°dH	
BASKETS		
Baskets Color	Grey	
Lower Basket	•	
Upper Basket	•	
Upper Basket Adjustment	Automatic 3 levels	
Cutlery Basket	13 settings	
DIMENSIONS/WEIGHT		
Overall dim - Width	23 - 9/16"	(598 mm)
Overall dim - Height (min - max)	33 - 13/16", 35 - 3/4"	(860 mm) - (910 mm)
Overall dim - Depth	23 - 3/16"	(589 mm)
Cut-out - Width	23 - 5/8"	(600 mm)
Cut-out - Height (min)	33 - 7/8"	(860 mm)
Cut-out - Depth (min - max)	22 - 5/8"	(575 mm)
Gross Weight	106 lbs	(48 kg)
POWER / RATINGS (115 V, 60 HZ)		
kW / Amps rating	1.4 kW - 13A	
Power Cable	Nema 5-15P	
INSTRUCTIONS FOR USE		
Use & Care Manual / Installation Manual	English / French / Spanish	

FULGOR
MILANO

A FAMILY A PASSION



There are few places in the world where food has been the very backbone of a culture like it has been in Italy for centuries. A passion for cooking, creating and using local ingredients, has inspired generations of Italian families and has made the kitchen the heart of the home. The aroma of long hours of food preparation, tables filled with recipes handed down generation to generation, accompanied with the perfect local wine are moments that linger in our memories and give us a sense of home even when we are far away. These things are what being Italian is all about. The Meneghetti Family has brought us the Fulgor Milano line of products so that we too may be inspired to cook and create with this same passion at home. Every Fulgor Milano product has been designed and developed to not only meet or exceed expectations of performance and quality, but also provide a design that is uniquely Italian.

DESIGNED IN ITALY



UGO MARINELLO

IDA Award winning designer Ugo Marinello is passionate about his work and his desire to synthesize modern rationality with traditional design. A graduate of IUAV in Venice, he draws inspiration from the unique architecture of that city, using it as a foundation to bring innovative yet timeless design and quintessential Italian spirit to your home and kitchen throughout the Fulgor Milano line.

ALFRED HENDRICKX

Known internationally for his mid-century furniture collections, designer Alfred Hendrickx began incorporating the strong lines of industrial styling and materials like stainless steel early in his career. After many successful design collaborations in Europe, he turned his attention to the design of household appliances, notably marrying modern form and function for Meneghetti and Fulgor Milano.



FULGOR
MILANO

Rosà - Vicenza - Italy
www.fulgor-milano.com
info@fulgor-milano.com



Every effort is made to ensure the information in this catalog is accurate at the time of publication.

For the most up-to-date information of any of the products or accessories in this catalog, please visit www.fulgor-milano.us
Meneghetti S.p.a. reserves the right to make updates to the information and products or discontinue models contained in this catalog without notice

cod. 0.050.046 - 01.2018

