

24" MULTIFUNCTION OVEN









CODE ID

700 SERIES OVEN

F7SM24S1



-  TFT Display
-  Automatic Cooking
-  Defrost
-  Keep Warm Function
-  Cool Touch Door
-  Fast Pre-Heat
-  Interior Lighting

SPECIFICATIONS

OVEN

Full Touch Controls
Display TFT 3,5"
Demo Mode
Chromed Racks
Door Cooling System
Event Logs (for Service)
Black Interior
Setting Temperature °C/°F
Setting Weight Kg/lb
Brightness Setting (ON condition)
Brightness Setting (OFF condition)
Beeper Volume Setting

OVEN FEATURES

Defrost
Dehydrate
Keep Warm
Keep Warm +
Bottom Bake
Bake
Eco Bake
Ring Convection Bake
Convection Down + Ring
Convection Bake
Broil Levels
Convection Down Bake
Convection Broil & Bottom
Convection Broil
Boost (fast preheat)
Internal Lighting



This product meets ADA (Americans with Disabilities Act) requirements. Please check with your local municipality's codes and stipulations for additional details to ensure compliance.

DISTINTO

24" MULTIFUNCTION OVEN

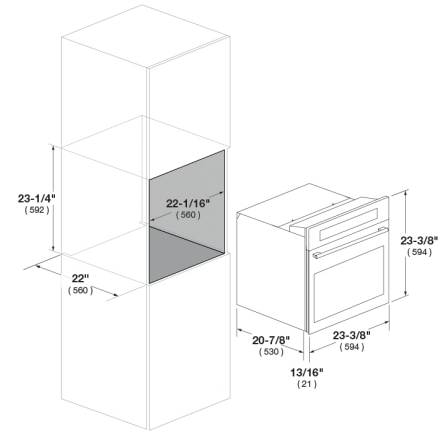

| CODE ID | 24" MULTIFUNCTION OVEN F7SM24S1 |
|--|------------------------------------|
| Type | TRADITIONAL |
| Size | 24" |
| Colour | INOX |
| Oven Type | Multifunction (True Euro Conv.) |
| Temperature Regulation | Electronic |
| CONTROL PANEL | |
| Control type | MODULAR - Electronic |
| Display | TFT 3,5" |
| Menu Recipes | • |
| Commands | Full Touch - (one board 9 keys) |
| Language | 12 |
| SPECIAL FEATURES | |
| Demo Mode | • |
| Brightness setting (ON condition) | • |
| Brightness setting (OFF condition) | • |
| Beeper volume setting | • |
| Date format | • |
| Child Door Lock | - |
| Sabbath mode | - |
| 12/24 hours clock format | • |
| kg/lb weight unit | • |
| °C/°F degree unit | • |
| Door micro switch | • |
| Event logs (for Service) | • |
| OVEN DOOR(S) | |
| Oven Glass Window | Panoramic Glass |
| Door Cooling System | 3 Pane Heat Resistant Glass |
| Door Hinges | Heavy Duty Steady Tilt |
| Handle style | Tubular Steel |
| OVEN CAVITY | |
| Muffle - Net Capacity (cbft) | 2.4 - Flat + Racks |
| Cavity Enameling Colour | Black |
| Rack Positions | 5 |
| Oven Lights | 1 x 20W Halogen |
| Broil Upper Heating Element | 1200 W (240V) |
| Upper Heating Element | 1000W (240V) |
| Concealed Bake Lower Heating Element | 1100 W (240V) |
| Convection Element Wattage | 2300W (240V) |
| OVEN ACCESSORIES | |
| Chromed racks | • |
| Enameled Grill set (basin + anti splash) | - |
| Telescopic chromed rack | - |
| Meat probe | - |
| DIMENSIONS/WEIGHT - (IN OR LBS) | |
| Overall dim - width | 23 3/8" (594mm) |
| Overall dim - height | 23 3/8" (594mm) |
| Overall dim - depth | 21 7/8" (556mm) |
| Cutout - width | 22 1/16" (560mm) |
| Cutout - height (min) | 23 3/8" (595mm) |
| Cutout - depth (min) | 22 1/16" (560mm) |
| POWER / RATINGS | |
| KW/Amps rating at 120/240V, 60Hz | 3.45kW - 14.3Amps |
| KW/Amps rating at 120/208V, 60Hz | 2.59kW - 12.4Amps |
| Cable + Conduit | • |
| INSTRUCTIONS FOR USE | |
| Instruction Manual | EN, FR |