

24" MULTIFUNCTION OVEN









CODE ID

700 SERIES OVEN

F7SM24S1



-  TFT Display
-  Automatic Cooking
-  Defrost
-  Keep Warm Function
-  Cool Touch Door
-  Fast Pre-Heat
-  Interior Lighting

SPECIFICATIONS

OVEN

Full Touch Controls
Display TFT 3,5"
Demo Mode
Chromed Racks
Door Cooling System
Event Logs (for Service)
Black Interior
Setting Temperature °C/°F
Setting Weight Kg/lb
Brightness Setting (ON condition)
Brightness Setting (OFF condition)
Beeper Volume Setting

OVEN FEATURES

Defrost
Dehydrate
Keep Warm
Keep Warm +
Bottom Bake
Bake
Eco Bake
Ring Convection Bake
Convection Down + Ring
Convection Bake
Broil Levels
Convection Down Bake
Convection Broil & Bottom
Convection Broil
Boost (fast preheat)
Internal Lighting



This product meets ADA (Americans with Disabilities Act) requirements. Please check with your local municipality's codes and stipulations for additional details to ensure compliance.

DISTINTO

24" MULTIFUNCTION OVEN

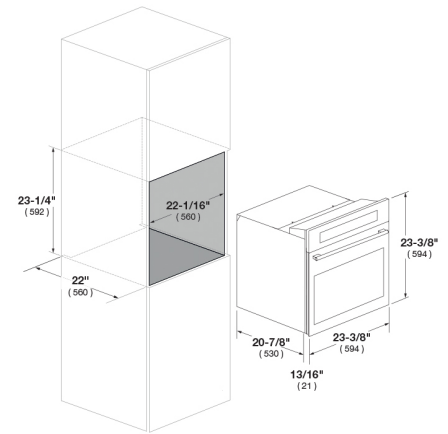

CODE ID	24" MULTIFUNCTION OVEN F7SM24S1
Type	TRADITIONAL
Size	24"
Colour	INOX
Oven Type	Multifunction (True Euro Conv.)
Temperature Regulation	Electronic
CONTROL PANEL	
Control type	MODULAR - Electronic
Display	TFT 3,5"
Menu Recipes	•
Commands	Full Touch - (one board 9 keys)
Language	12
SPECIAL FEATURES	
Demo Mode	•
Brightness setting (ON condition)	•
Brightness setting (OFF condition)	•
Beeper volume setting	•
Date format	•
Child Door Lock	-
Sabbath mode	-
12/24 hours clock format	•
kg/lb weight unit	•
°C/°F degree unit	•
Door micro switch	•
Event logs (for Service)	•
OVEN DOOR(S)	
Oven Glass Window	Panoramic Glass
Door Cooling System	3 Pane Heat Resistant Glass
Door Hinges	Heavy Duty Steady Tilt
Handle style	Tubular Steel
OVEN CAVITY	
Total Capacity (lt)	66,8
Total Capacity (cu. ft.)	2,36
Cavity Enameling Colour	Black
Rack Positions	5
Oven Lights	1 x 20W Halogen
Broil Upper Heating Element	1200 W (240V)
Upper Heating Element	1000W (240V)
Concealed Bake Lower Heating Element	1100 W (240V)
Convection Element Wattage	2300W (240V)
OVEN ACCESSORIES	
Chromed racks	•
Enameled Grill set (basin + anti splash)	-
Telescopic chromed rack	-
Meat probe	-
DIMENSIONS/WEIGHT - (IN OR LBS)	
Overall dim - width	23 3/8" (594mm)
Overall dim - height	23 3/8" (594mm)
Overall dim - depth	21 7/8" (556mm)
Cutout - width	22 1/16" (560mm)
Cutout - height (min)	23 3/8" (595mm)
Cutout - depth (min)	22 1/16" (560mm)
POWER / RATINGS	
KW/Amps rating at 120/240V, 60Hz	3.45kW - 14.3Amps
KW/Amps rating at 120/208V, 60Hz	2.59kW - 12.4Amps
Cable + Conduit	•
INSTRUCTIONS FOR USE	
Instruction Manual	EN, FR