

OVEN 700 SERIES 30"













CODE ID

30" TOUCH CONTROL SINGLE OVEN - WHITE GLASS

F7SP30W1



-  **CREACTIVE COOKING SYSTEM**
-  **PIZZA COOKING MODE 590 °F**
-  Dual Convection
-  Self Clean Oven
-  Multi-level cooking
-  1 Telescopic Rack
-  Cool Touch Door
-  TFT Display
-  Meat Probe
-  Fast Pre-Heat
-  Interior Lighting

OVEN

Creative Touch Control System
Dual True Convection
Self-cleaning oven with Multifunction baking
Black Porcelain enamel interior
Cool to the touch
Extra-large baking cavity and viewing area
3 Halogen lights for flawless visibility
Gross capacity 4.4 cu. ft.
2 chromed racks
1 telescopic rack
Enameled Broiler Pan
Lock Keys
Door Lock

OVEN FUNCTIONS

Bake (cooking group)
Broil
Convection (cooking group)
Keep Warm (cooking group)
Recipes
Classic Pizza Function 590°F
Preset default temperature
Preheat (display instantaneous temperature)
Fast Preheat Mode
Sabbath Mode
Setting Temperature °C/°F
Setting Weight Kg/lb
Event Logs (for Service)
Meat Probe
Self-Clean

OPTIONAL ACCESSORIES

FMTR630 30" Telesc. Rack

DISTINTO

30" TOUCH CONTROL SINGLE OVEN



F7SP30S1
Stainless Steel



F7SP30B1
Black Glass



F7SP30W1
White Glass

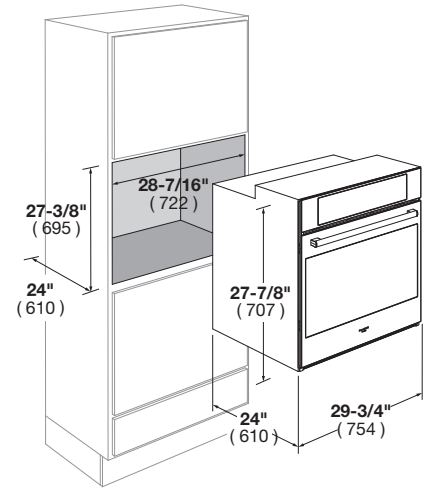

| CODE ID | F7SP30S1 30" TOUCH CONTROL DOUBLE OVEN | F7SP30B1 30" TOUCH CONTROL DOUBLE OVEN | F7SP30W1 30" TOUCH CONTROL DOUBLE OVEN |
|--|--|---|---|
| Series and Finish | 700 Series - Stainless Steel | 700 Series - Black Glass | 700 Series - White Glass |
| CONTROL PANEL | Creative Electronic Touch Control | | |
| Control Type | TFT 3.5" | | |
| Display: Clock - Temperature - Function | English (USA) / English (UK) / French / Spanish / Italian / German | | |
| Language | Control Interface | Chime Volume Setting | |
| | Full Touch: Functions - Recipes | Date Format | |
| | Settings Menu - Brightness Setting | Demo Mode | |
| OVEN | Dual True Convection | | |
| Type | Electronic Control (min/max 170/550°F - 75/290°C) | | |
| Temperature Regulation | | | |
| OVEN FUNCTIONS | Pyrolytic Self-Clean | Broil | |
| | True Convection | Dehydrate | |
| | Convection Broil | Thaw (Defrost) | |
| | Convection Roast | Proof (Warm) | |
| | Pizza (Lower Convection) | Keep warm (Warm Plus) | |
| | Bake | Oven Lights | |
| ELECTRIC OVEN FEATURES | Preset default temperature | Display instantaneous temperature | |
| | Child Door Lock | Control Display Lock | |
| | Sabbath Mode | 12/24 Hour Clock Formats | |
| | Automatic Fast Preheat | Display | |
| | Meat Probe (Upper Oven Only) | Event Logs (for Service) | |
| OVEN DOOR(S) | Large See Through Glass | | |
| Oven Glass Window | 4 Heat Resistant Glasses | | |
| Door Cooling System | Heavy Duty Steady Tilt | | |
| Door Hinges | | | |
| OVEN CAVITY | 4.4 | | |
| Gross Capacity (cbft) | 4.1 | | |
| Usable Capacity (cbft) | Black | | |
| Cavity Enamel Colour | 6 | | |
| Rack Positions | 3x20W Halogen | | |
| Oven Lights | | | |
| HEATING ELEMENTS (@240V) | 3500 W | | |
| Broil Upper Heating Element | 1032 W | | |
| Upper Auxiliary Element | 3000 W | | |
| Concealed Bake Lower Heating Element | 2 x 1300 W | | |
| Convection Element | | | |
| OVEN ACCESSORIES | 2 | | |
| Chromed Racks | 1 | | |
| Enameled Broiler Pan (basin + anti splash) | 1 | | |
| Telescopic Chromed Rack | | | |
| DIMENSIONS/WEIGHT | Overall dim - Width | 29 - 11/16" | (754 mm) |
| | Overall dim - Height | 27 - 7/8" | (707 mm) |
| | Overall dim - Depth | 24" | (610 mm) |
| | Cut-out - Width | 28 - 7/16" | (722 mm) |
| | Cut-out - Height (min) | 27 - 3/8" | (695 mm) |
| | Cut-out - Depth (min) | 23 - 1/4" | (590 mm) |
| | Gross Weight | 183 lbs | (83 kg) |
| POWER / RATINGS (208/240 V, 60 HZ) | 3.70kW - 15.4A | | |
| kW / Amps rating at 120-240V, 60Hz | 3.50kW - 16.8A | | |
| kW / Amps rating at 120-208V, 60Hz | Conduit | | |
| Power Cable | | | |
| INSTRUCTIONS FOR USE | English / French / Spanish | | |
| Use & Care Manual / Installation Manual | | | |