

# ASQ05LL

## GE® 115 Volt Electronic Room Air Conditioner

### Wall Case Dimensions and Installation Information (in inches)

**Note:** When installing slide-out chassis units in through-the-wall applications, keep louvers free. Do not restrict air flow areas. Fixed chassis units are not suitable for through-the-wall applications.

**Wall Outlets:** All wiring including installation of receptacle must be made in accordance with local electrical codes and regulations. Electrical outlet should be in reach of line cord.

**Note:** Aluminum wiring may pose special problems – consult a qualified electrician.

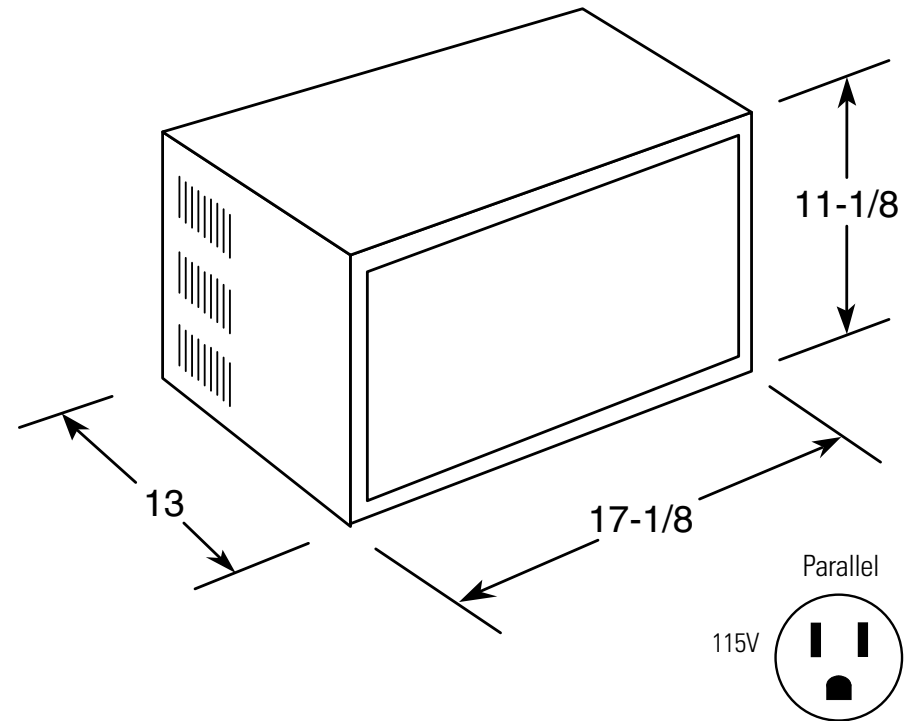

For answers to your Monogram®, GE Profile™ or GE® appliance questions, visit our website at [ge.com](http://ge.com) or call GE Answer Center® service, 800.626.2000.



imagination at work



Total volume and shelf area are calculated by the Association of Home Appliance Manufacturers' standards.



Listed by Underwriters Laboratories

# ASQ05LL

## GE® 115 Volt Electronic Room Air Conditioner

### Features and Benefits

- 5,050 BTU, 9.7 EER, 115 Volts
- 3 Cooling / 3 Fan Only Speeds
- Electronic Thermostat with Remote
- Energy Saver Feature
- Sleep function
- Fixed Chassis
- 24 hour on/off timer
- EZ Mount Window Installation
- Power Interruption Restart
- Light Cool Grey

