



Refrigerators

Safety Information 2-3

Operating Instructions

Care and Cleaning 6, 7

Control Settings 4

Refrigerator Features 5

Installation Instructions . . . 8-10

Troubleshooting Tips . . . 11, 12

Consumer Support

Consumer Support 14

Warranty 13

**Owner's Manual
& Installation
Instructions**

GMRO5 BLPWW/BB

Write the model and serial numbers here:

Model # _____

Serial # _____

Find these numbers on a label inside the refrigerator on the side wall.



IMPORTANT SAFETY INFORMATION. READ ALL INSTRUCTIONS BEFORE USING.

⚠ WARNING!

Use this appliance only for its intended purpose as described in this Owner's Manual.



SAFETY PRECAUTIONS

When using electrical appliances, basic safety precautions should be followed, including the following:

- This refrigerator must be properly installed and located in accordance with the Installation Instructions before it is used.
 - Do not allow children to climb, stand or hang on the shelves in the refrigerator. They could damage the refrigerator and seriously injure themselves.
 - Do not store or use gasoline or other flammable vapors and liquids in the vicinity of this or any other appliance.
 - Keep fingers out of the "pinch point" areas; clearances between the doors and between the doors and cabinet are necessarily small. Be careful closing doors when children are in the area.
 - Unplug the refrigerator before cleaning and making repairs.
- NOTE:** We strongly recommend that any servicing be performed by a qualified individual.
- Turning the temperature control dial to the **OFF** position stops cooling but does not shut off power to the refrigerator.

⚠ DANGER! RISK OF CHILD ENTRAPMENT PROPER DISPOSAL OF THE REFRIGERATOR

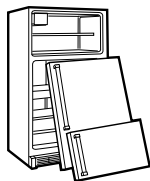

Child entrapment and suffocation are not problems of the past. Junked or abandoned refrigerators are still dangerous... even if they will sit for "just a few days." If you are getting rid of your old refrigerator, please follow the instructions below to help prevent accidents.

Before You Throw Away Your Old Refrigerator or Freezer:

- Take off the doors.
- Leave the shelves in place so that children may not easily climb inside.

CFC Disposal

Your old refrigerator has a cooling system that used CFCs (chlorofluorocarbons). CFCs are believed to harm stratospheric ozone.

If you are throwing away your old refrigerator, make sure the CFC refrigerant is removed for proper disposal by a qualified servicer. If you intentionally release this CFC refrigerant you can be subject to fines and imprisonment under provisions of environmental legislation.



USE OF EXTENSION CORDS

Because of potential safety hazards under certain conditions, we strongly recommend against the use of an extension cord.

However, if you must use an extension cord, it is absolutely necessary that it be a CSA approved, 3-wire grounding type appliance extension cord having a grounding type plug and outlet and that the electrical rating of the cord be 15 amperes (minimum) and 120 volts.



HOW TO CONNECT ELECTRICITY

Do not, under any circumstances, cut or remove the third (ground) prong from the power cord. For personal safety, this appliance must be properly grounded.

The power cord of this appliance is equipped with a 3-prong (grounding) plug which mates with a standard 3-prong (grounding) wall outlet to minimize the possibility of electric shock hazard from this appliance.

Have the wall outlet and circuit checked by a qualified electrician to make sure the outlet is properly grounded.

If you have only a standard 2-prong wall outlet, it is your personal responsibility and obligation to have it replaced with a properly grounded 3-prong wall outlet.

The refrigerator should always be plugged into its own individual electrical outlet which has a voltage rating that matches the rating plate.

This provides the best performance and also prevents overloading house wiring circuits which could cause a fire hazard from overheated wires.

Never unplug your refrigerator by pulling on the power cord. Always grip plug firmly and pull straight out from the outlet.

Repair or replace immediately all power cords that have become frayed or otherwise damaged. Do not use a cord that shows cracks or abrasion damage along its length or at either end.

When moving the refrigerator away from the wall, be careful not to roll over or damage the power cord.

About the control on the refrigerator.

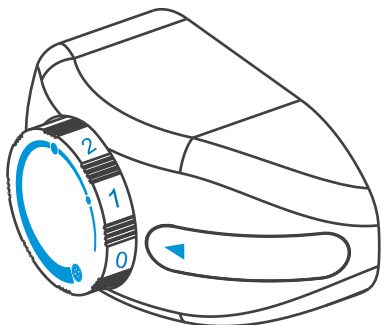

Temperature Control

Your refrigerator has one control for regulating the temperature. The temperature control is located on the upper right hand corner of the interior compartment.

The first time you turn the unit on, adjust the temperature control knob to "7" and run for at least 2 hours before putting foods inside. This will ensure the cabinet is thoroughly chilled before food is put in.

The range of the refrigerator temperature control is from position "1" the warmest to "7" the coldest. Adjust the temperature control to the setting that best suits your needs.

Turning the temperature control knob to "0" position stops the cooling cycle but does not shut off the power to the unit.

Shelves

To remove a shelf, lift up the back slightly and pull forward. Some models have multi-position shelves that can be moved to different levels.

Ice Tray Compartment

This compartment is designed for production of ice cubes and short-term storage (a few days at most) of some commercially-frozen foods when in contact with the evaporator (cold surface in compartment.)

Door Shelves

Shelves on the door provide convenient storage for frequently used items. Some models have doors that are deep enough to store large bottles.

Key-Ejecting Lock *(on some models)*

The key for the spring-loaded lock is automatically ejected—key will not remain in lock in either the open or closed position.

Keep the key out of reach of children and away from the refrigerator.

If a replacement key is needed, it can be ordered by visiting our Website, **GEAppliances.ca**, or calling GE Parts and Accessories, 1.888.261.3055 Order part WR05X10006.

Care and cleaning of the refrigerator.

Cleaning the Outside

Keep the outside clean. Wipe with a clean cloth lightly dampened with kitchen appliance wax or mild liquid dish detergent. Dry and polish with a clean, soft cloth.

Do not wipe the refrigerator with a soiled dish cloth or wet towel. These may leave a residue that can erode the paint. Do not use scouring pads, powdered cleaners, bleach or cleaners containing bleach because these products can scratch and weaken the paint finish.

Protect the paint finish. The finish on the outside of the refrigerator is a high quality, baked-on paint finish. With proper care, it will stay new-looking and rust-free for years. Apply a coat of kitchen/appliance wax when the refrigerator is new, and then at least twice a year.

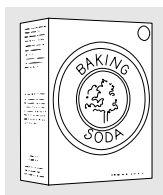

Cleaning the Inside

To help prevent odors, leave an open box of baking soda in the refrigerator.

Unplug the refrigerator before cleaning. If this is not practical, wring excess moisture out of sponge or cloth when cleaning around the control.

Use warm water and baking soda solution—about a tablespoon (15 ml) of baking soda to a quart (1 liter) of water. This both cleans and neutralizes odors. Rinse and wipe dry.

Other parts of the refrigerator—including door gaskets, fruit and vegetable drawers, and all plastic parts—can be cleaned the same way.

Do not wash any plastic refrigerator parts in the dishwasher.

Care and cleaning of the refrigerator.

www.GEAppliances.ca

Safety Instructions

Operating Instructions

Installation Instructions

Troubleshooting Tips

Consumer Support

Defrosting

Defrost whenever frost on the wall of the ice tray compartment becomes 1/4" thick. **Never use a sharp or metallic instrument to remove frost as it may damage the cooling coils.** (A punctured cooling coil will cause serious problems and void the warranty.) We recommend using a plastic scraper. Do not use any electrical device in defrosting your refrigerator.

To defrost, remove foods and ice trays from the ice tray compartment. Set the temperature control dial at **OFF** position. Defrosting usually takes a few hours. To defrost faster, keep the door open. Also, pouring warm (not hot) water on the frosted part may speed defrosting. **Do not use boiling water**—it may damage plastic parts.

After defrosting, empty water from the drip tray. Wash the drip tray in warm water. Wipe the ice tray compartment with a damp cloth. Then turn the temperature control to the desired setting and return food and ice trays to the refrigerator.

NOTE: If ice build up is very thick, it may keep the ice tray compartment door from opening or closing completely. Don't try to force it open; after defrosting, the door will open and close easily.

Preparing for Vacation

For long vacations or absences, remove food and unplug the refrigerator. Move the control to the **OFF** position, and clean the interior with a baking soda solution of one tablespoon (15 ml) of baking soda to one quart (1 liter) of water. Leave the door open.

Preparing to Move

Secure all loose items such as shelves and ice trays by taping them securely in place to prevent damage.

Be sure the refrigerator stays in an upright position during moving.

Preparing to install the refrigerator.

Read these instructions completely and carefully.



Refrigerator Location

- Do not install the refrigerator where the temperature will go below 50°F (10°C) because it will not run often enough to maintain proper temperatures.
- Install it on a floor strong enough to support it fully loaded.
- If the 2 cubic foot model is placed on a countertop or stand, the front surface of the door should be 3" or more back from the edge of the countertop or stand to avoid accidental tipping of the appliance during normal use.
- Do not install it closer than 5" (13 cm) next to a range.
- Do not install it in a recessed area.
- Do not build in the refrigerator.

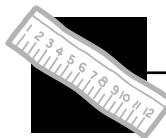

Clearances

Allow the following clearances for ease of installation and proper air circulation.

Sides 1/2" (13 mm)

Top 2" (51 mm)

Back 2" (51 mm) from the rear cabinet surface to the wall

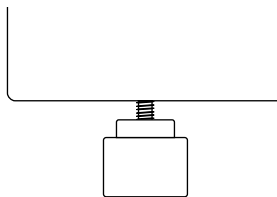

Leveling Legs (on some models)

Adjustable legs at the front corners of the refrigerator should be set so the refrigerator is firmly positioned on the floor and the front is raised just enough that the door closes easily when opened about halfway.

To adjust the leveling legs, turn the legs **counterclockwise to raise** the refrigerator, **clockwise to lower** it.

Turn counterclockwise to raise,
clockwise to lower.

Preparing to install the refrigerator.

www.GEAppliances.ca

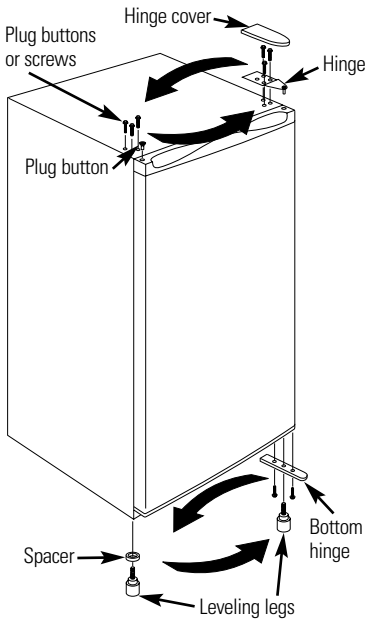

Door Reversal

3 Cubic Foot Models and on some 4 Cubic Foot Models

1. Remove the small plug button on the left side of the door top cap.
 2. Remove the three plug buttons or screws on the left side on top of the cabinet.
 3. Remove the plastic hinge cover by lifting it up by the front edge.
 4. Remove the three screws from the top hinge.
 5. Lift the door up and off the bottom hinge (right side).
 6. Tilt the refrigerator cabinet back to remove the right leveling leg.
 7. Remove the screws on the bottom hinge (right side) and the left leveling leg. Move the bottom hinge to the left side and secure it with the screws and leveling leg.
- IMPORTANT:** The left leg has a spacer that must be moved to the right side leveling leg when the door swing is reversed.
8. Screw the right leveling leg, with the spacer in place, back in place on the right side.
 9. Position the door on the left bottom hinge. With the magnetic gasket holding the door in place, secure the top hinge with screws.
 10. **Make sure the door is aligned with the refrigerator cabinet before continuing.**
 11. Replace the hinge cover on top of the hinge.
 12. Put the plug button in the hole on the right side of the door cap.
 13. Put the three plug buttons on the right side on top of the cabinet.

Preparing to install the refrigerator.

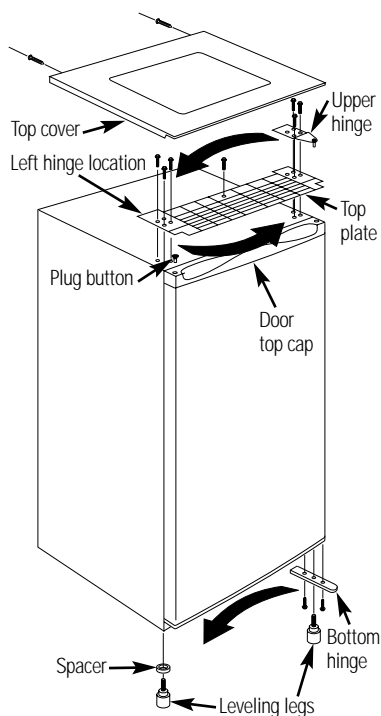

Door Reversal (on some models)

4 Cubic Foot Models

1. Remove the two screws at the back of the top cover.
 2. Remove the top cover by lifting the back up about 2" and then sliding it forward.
 3. Remove the small plug button on the left side of the door top cap.
 4. Remove the three screws on the upper hinge (right side). Remove the hinge.
 5. Remove the three screws at the left hinge location on the top plate.
 6. Remove the screw in the middle of the top plate and remove the top plate.
 7. Lift the door up and off the bottom hinge (right side).
 8. Tilt the refrigerator cabinet back to remove the right leveling leg.
 9. Remove the screws on the bottom hinge (right side) and the left leveling leg. Move the bottom hinge to the left side and secure it with the screws and leveling leg.
- IMPORTANT:** The left leg has a spacer that must be moved to the right side leveling leg when the door swing is reversed.
10. Screw the right leveling leg, with the spacer in place, back in place on the right side.
 11. Position the door on the left bottom hinge. With the magnetic gasket holding the door in place, secure the top hinge with screws.
 12. **Make sure the door is aligned with the refrigerator cabinet before continuing.**
 13. Replace the top plate and screws.
 14. Slide the top cover back in place and replace the two screws.
 15. Put the plug button in the hole on the right side of the door top cap.



Troubleshooting Tips

Save time and money! Review the chart below first and you may not need to call for service.

Problem	Possible Causes	What To Do
Refrigerator does not operate	Control in OFF position.	<ul style="list-style-type: none"> • Move the control to a temperature setting.
	Refrigerator is unplugged.	<ul style="list-style-type: none"> • Push the plug completely into the outlet.
	The fuse is blown/ circuit breaker is tripped.	<ul style="list-style-type: none"> • Replace fuse or reset the breaker.
Vibration or rattling (slight vibration is normal)	Front leveling legs (on some models) need adjusting.	<ul style="list-style-type: none"> • See <i>Leveling Legs</i>.
	Refrigerator is on an uneven surface.	<ul style="list-style-type: none"> • Use shims to level the refrigerator.
Motor operates for long periods or cycles	Normal when refrigerator is first plugged in.	<ul style="list-style-type: none"> • Wait 24 hours for the refrigerator to completely cool down.
	Often occurs when large amounts of food are placed in refrigerator.	<ul style="list-style-type: none"> • This is normal.
	Door left open.	<ul style="list-style-type: none"> • Check to see if package is holding door open.
	Hot weather or frequent door openings.	<ul style="list-style-type: none"> • This is normal.
	Temperature control set at the coldest setting.	<ul style="list-style-type: none"> • See <i>About the control</i>.
	Not enough clearance from the wall.	<ul style="list-style-type: none"> • Make sure there is enough air circulation around the refrigerator.
Door will not open	Refrigerator is locked (lock is available on some models).	<ul style="list-style-type: none"> • Unlock the door with the key. If the key has been lost, a replacement key can be ordered by visiting our Website, www.GEappliances.ca, or calling GE Parts and Accessories, 1.888.261.3055 Order part WR05X10006.

Before you call for service...

Problem	Possible Causes	What To Do
Refrigerator too warm	Temperature control not set cold enough.	• See <i>About the control</i> .
	Warm weather or frequent door openings.	• Set the temperature control one step colder. See <i>About the control</i> .
	Door left open.	• Check to see if package is holding door open.
	Cabinet sides are warm.	• This is normal for a hot wall type condenser.
Refrigerator has odor	Foods transmitting odor to refrigerator.	• Foods with strong odors should be tightly wrapped. • Keep an open box of baking soda in the refrigerator; replace every three months.
	Interior needs cleaning.	• See <i>Care and cleaning</i> .
	Defrost water pan needs cleaning.	• See <i>Care and cleaning</i> .
Moisture forms on outside of refrigerator	Not unusual during periods of high humidity.	• Wipe surface dry.
Moisture collects inside (in humid weather, air carries moisture into refrigerator when door is opened)	Too frequent or too long door openings.	
Refrigerator too cold	Temperature control set too cold.	• See <i>About the control</i> .

Refrigerator Warranty.



Your refrigerator is warranted to be free of defects in material and workmanship.

What is covered	How Long Warranted (From Date of Sale)	Parts Repair or Replace at Mabe's Option	Labour
Compressor	One (1) year	One (1) year	One (1) year
Sealed System (including evaporator, condenser tubing and refrigerant)	One (1) year	One (1) year	One (1) year
All Other Parts	One (1) year	One (1) year	One (1) year

Terms and Conditions:

1. This warranty applies only for single Refrigerator has been properly installed Refrigerator has been properly installed according to the instructions supplied by Mabe and is connected to an adequate and proper utility service.

Damage due to abuse, accident, commercial use, and alteration or defacing of the serial plate cancels all obligations of this warranty.

Service during this warranty period must be performed by an Authorized Mabe Service Agent.

2. Neither Mabe nor the Dealer is liable for any claims or damages resulting from failure of the Refrigerator or from service delays beyond their reasonable control.

3. To obtain warranty service, purchaser must present the original Bill of Sale. Components repaired or replaced are warranted through the remainder of the original warranty period only.

4. This warranty is in addition to any statutory warranty.

5. This warranty is extended to the original purchaser and any succeeding owner for products purchased in Canada for home use within Canada. In home warranty service will be provided in areas where it is available and deemed reasonable by Mabe to provide.

What is not covered:

- Service trips to your home to teach you how to use the product.
- Damage to finish must be reported within 48 hours following the delivery by contacting the retail outlet of where it was purchased.
- Improper installation – proper installation includes adequate air circulation to the refrigeration system, adequate electrical, plumbing and other connecting facilities.
- Replacement of house fuses or resetting of circuit breakers.
- Replacement of light bulbs.
- Damage to product caused by accident, fire, floods or acts of God.
- Loss of food due to spoilage.
- Proper use and care of product as listed in the owner's manual, proper setting of controls.

WARRANTOR IS NOT RESPONSIBLE FOR CONSEQUENTIAL DAMAGE.

EXCLUSION OF IMPLIED WARRANTIES – Your sole and exclusive remedy is product repair as provided in this Limited Warranty. Any implied warranties, including the implied warranties of merchantability or fitness for a particular purpose, are limited to one year or the shortest period allowed by law.

Warrantor: Mabe Canada Inc.

IMPORTANT

Keep this warranty and your bill of sale as proof of original purchase and purchase date.

Mabe Service is available coast to coast. If further help is needed concerning this warranty, contact:

Manager, Consumer Relations,
Mabe Canada, Inc., Consumer Service
Suite 310, 1 Factory Lane,
Moncton, N.B. E1C 9M3

Staple your receipt here.
Proof of the original purchase date is needed to obtain service under the warranty.

Consumer Support.



GE Appliances Website

www.GEappliances.ca

Have a question or need assistance with your appliance? Try the GE Appliances Website 24 hours a day, any day of the year! For greater convenience and faster service, you can now download Owner's Manuals, Installation Instructions and product specifications



Schedule Service

www.GEappliances.ca

Expert GE repair service is only one step away from your door. Call 1.800.361.3400 during normal business hours.



Contact Us

www.GEappliances.ca

If you are not satisfied with the service you receive from GE, contact us on our Website with all the details including your phone number, or write to:

Director, Consumer Relations, Mabe Canada Inc.
Suite 310, 1 Factory Lane
Moncton, N.B. E1C 9M3



Register Your Appliance

www.GEappliances.ca

Register your new appliance on-line—at your convenience! Timely product registration will allow for enhanced communication and prompt service under the terms of your warranty, should the need arise. You may also mail in the pre-printed registration card included in the packing material.