



# Self-Cleaning Gas Ranges

**Safety Instructions** .....2-7

**Operating Instructions**

Aluminum Foil .....13  
Clock and Timer .....15, 16  
Oven .....10-25  
    Baking and Roasting .....13  
    Broiling, Broiling Guide .....14  
    Oven Control .....10, 11  
    Power Outage .....12, 16  
    Preheating .....13  
    Sabbath Feature .....19, 20  
    Self-Cleaning .....24, 25  
    Special Features .....18  
    Thermostat Adjustment .....21  
    Timed Baking  
    and Roasting .....17  
Surface Cooking .....8, 9  
Warming Drawer .....22, 23

**Care and Cleaning**

Burner Assembly .....26-28  
Burner Grates .....26  
Control Panel and Knobs .....32  
Cooktop Surface .....29  
Door Removal .....30  
Kick Panel .....31  
Lift-Up Cooktop .....29  
Oven Bottom .....30  
Oven Light Replacement .....32  
Oven Vents .....29  
Self-Cleaning .....24, 25  
Racks .....32  
Stainless Steel Surfaces .....29  
Storage Drawer .....31  
Warming Drawer .....31

**Installation**

**Instructions** .....33-44  
Air Adjustment .....43  
Anti-Tip Device .....36, 44  
Checking Burner Ignition .....42  
Connecting the Range  
to Gas .....37-40  
Dimensions and Clearances ..35  
Electrical Connections ....41, 42  
Leveling the Range .....43  
Location .....36  
LP .....44

**Troubleshooting**

**Tips** .....45-48

**Accessories** .....49

**Consumer Support**

Consumer  
Support .....Back Cover  
Warranty for Customers  
in Canada .....51  
Warranty for Customers  
in the U.S.A. ....50

**Owner's Manual  
& Installation  
Instructions**

EGR3000  
EGR3001  
JGB280  
JGB290  
JGB300  
JGB400  
JGBP25  
JGBP26  
JGBP27  
JGBP28  
JGBP29  
JGBP33

**Write the model and serial numbers here:**

**Model #** \_\_\_\_\_

**Serial #** \_\_\_\_\_

You can find them on a label on the front of the range behind the warming drawer, storage drawer or kick panel.

In Canada contact us at:  
www.GEAppliances.ca

# IMPORTANT SAFETY INFORMATION. READ ALL INSTRUCTIONS BEFORE USING.

## ⚠️ WARNING!

For your safety, the information in this manual must be followed to minimize the risk of fire or explosion, electric shock, or to prevent property damage, personal injury, or loss of life.



**⚠️ WARNING:** If the information in this manual is not followed exactly, a fire or explosion may result causing property damage, personal injury or death.

- Do not store or use gasoline or other flammable vapors and liquids in the vicinity of this or any other appliance.
- **WHAT TO DO IF YOU SMELL GAS**
  - Do not try to light any appliance.
  - Do not touch any electrical switch; do not use any phone in your building.
  - Immediately call your gas supplier from a neighbor's phone. Follow the gas supplier's instructions.
  - If you cannot reach your gas supplier, call the fire department.
- Installation and service must be performed by a qualified installer, service agency or the gas supplier.



## ANTI-TIP DEVICE



### ⚠️ WARNING

- All ranges can tip.
- BURNS or other SERIOUS INJURIES can result.
- INSTALL and CHECK the ANTI-TIP bracket following the instructions supplied with the bracket.

To reduce the risk of tipping the range, the range must be secured by a properly installed anti-tip bracket. See installation instructions shipped with the bracket for complete details before attempting to install.

To check if the bracket is installed and engaged properly, carefully tip the range forward. The bracket should stop the range within 4 inches. If it does not, the bracket must be reinstalled. If the range is pulled from the wall for any reason, always repeat this procedure to verify the range is properly secured by the anti-tip bracket.

For free-standing or slide-in ranges, never completely remove the leveling legs or the range will not be secured to the anti-tip device properly.

If you did not receive an anti-tip bracket with your purchase, call 1.800.626.8774 to receive one at no cost (in Canada, call 1.800.561.3344). For installation instructions of the bracket, visit [GEAppliances.com](http://GEAppliances.com) (in Canada, [GEAppliances.ca](http://GEAppliances.ca)).

## **⚠ WARNING!**



### IMPORTANT SAFETY NOTICE

*The California Safe Drinking Water and Toxic Enforcement Act requires the Governor of California to publish a list of substances known to the state to cause birth defects or other reproductive harm, and requires businesses to warn customers of potential exposure to such substances.*

*Gas appliances can cause minor exposure to four of these substances, namely benzene, carbon monoxide, formaldehyde and soot, caused primarily by the incomplete combustion of natural gas or LP fuels. Properly adjusted burners, indicated by a bluish rather than a yellow flame, will minimize incomplete combustion. Exposure to these substances can be minimized by venting with an open window or using a ventilation fan or hood.*



### SAFETY PRECAUTIONS

*Have the installer show you the location of the range gas shut-off valve and how to shut it off if necessary.*

- Have your range installed and properly grounded by a qualified installer, in accordance with the Installation Instructions. Any adjustment and service should be performed only by qualified gas range installers or service technicians.
- Do not attempt to repair or replace any part of your range unless it is specifically recommended in this manual. All other service should be referred to a qualified technician.
- Plug your range into a 120-volt grounded outlet only. Do not remove the round grounding prong from the plug. If in doubt about the grounding of the home electrical system, it is your personal responsibility and obligation to have an ungrounded outlet replaced with a properly grounded, three-prong outlet in accordance with the National Electrical Code. Do not use an extension cord with this appliance.

# IMPORTANT SAFETY INFORMATION. READ ALL INSTRUCTIONS BEFORE USING.

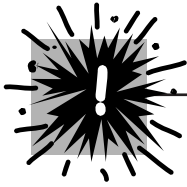

## SAFETY PRECAUTIONS

- Locate the range out of kitchen traffic path and out of drafty locations to prevent poor air circulation.
  - Be sure all packaging materials are removed from the range before operating it to prevent fire or smoke damage should the packaging material ignite.
  - Be sure your range is correctly adjusted by a qualified service technician or installer for the type of gas (natural or LP) that is to be used. Your range can be converted for use with either type of gas. See the *Installation of the range* section.
- ⚠ WARNING:** These adjustments must be made by a qualified service technician in accordance with the manufacturer's instructions and all codes and requirements of the authority having jurisdiction. Failure to follow these instructions could result in serious injury or property damage. The qualified agency performing this work assumes responsibility for the conversion.
- After prolonged use of a range, high floor temperatures may result and many floor coverings will not withstand this kind of use. Never install the range over vinyl tile or linoleum that cannot withstand such type of use. Never install it directly over interior kitchen carpeting.
  - Do not leave children alone or unattended where a range is hot or in operation. They could be seriously burned.
  - Do not allow anyone to climb, stand or hang on the oven door, storage drawer, warming drawer or cooktop. They could damage the range and even tip it over, causing severe personal injury.
- ⚠ CAUTION:** Items of interest to children should not be stored in cabinets above a range or on the backsplash of a range—children climbing on the range to reach items could be seriously injured.
- ⚠ WARNING:** NEVER use this appliance as a space heater to heat or warm the room. Doing so may result in carbon monoxide poisoning and overheating of the oven.
- Never wear loose-fitting or hanging garments while using the appliance. Be careful when reaching for items stored in cabinets over the range. Flammable material could be ignited if brought in contact with flame or hot oven surfaces and may cause severe burns.
  - Do not store flammable materials in an oven, a range storage drawer, a warming drawer or near a cooktop.
  - Do not store or use combustible materials, gasoline or other flammable vapors and liquids in the vicinity of this or any other appliance.
  - Do not let cooking grease or other flammable materials accumulate in or near the range.
  - Do not use water on grease fires. Never pick up a flaming pan. Turn the controls off. Smother a flaming pan on a surface burner by covering the pan completely with a well-fitting lid, cookie sheet or flat tray. Use a multi-purpose dry chemical or foam-type fire extinguisher.
- Flaming grease outside a pan can be put out by covering it with baking soda or, if available, by using a multi-purpose dry chemical or foam-type fire extinguisher.
- Flame in the oven or warming drawer can be smothered completely by closing the oven door and turning the control to off or by using a multi-purpose dry chemical or foam-type fire extinguisher.
- Let the burner grates and other surfaces cool before touching them or leaving them where children can reach them.
  - Never block the vents (air openings) of the range. They provide the air inlet and outlet that are necessary for the range to operate properly with correct combustion. Air openings are located at the rear of the cooktop, at the top and bottom of the oven door, and at the bottom of the range under the warming drawer, kick panel or storage drawer.
  - Large scratches or impacts to glass doors can lead to broken or shattered glass.

## ⚠️ WARNING!

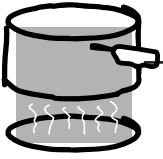

### SURFACE BURNERS

Use proper pan size—avoid pans that are unstable or easily tipped. Select cookware having flat bottoms large enough to cover burner grates. To avoid spillovers, make sure cookware is large enough to contain the food properly. This will both save cleaning time and prevent hazardous accumulations of food, since heavy spattering or spillovers left on range can ignite. Use pans with handles that can be easily grasped and remain cool.

- Always use the **LITE** position when igniting the top burners and make sure the burners have ignited.
- Never leave the surface burners unattended at high flame settings. Boilovers cause smoking and greasy spillovers that may catch on fire.
- Adjust the top burner flame size so it does not extend beyond the edge of the cookware. Excessive flame is hazardous.
- Use only dry pot holders—moist or damp pot holders on hot surfaces may result in burns from steam. Do not let pot holders come near open flames when lifting cookware. Do not use a towel or other bulky cloth in place of a pot holder.
- When using glass cookware, make sure it is designed for top-of-range cooking.
- To minimize the possibility of burns, ignition of flammable materials and spillage, turn cookware handles toward the side or back of the range without extending over adjacent burners.
- Carefully watch foods being fried at a high flame setting.
- Always heat fat slowly, and watch as it heats.
- Do not leave any items on the cooktop. The hot air from the vent may ignite flammable items and will increase pressure in closed containers, which may cause them to burst.
- If a combination of oils or fats will be used in frying, stir together before heating or as fats melt slowly.
- Use a deep fat thermometer whenever possible to prevent overheating fat beyond the smoking point.
- Use the least possible amount of fat for effective shallow or deep-fat frying. Filling the pan too full of fat can cause spillovers when food is added.
- Do not flame foods on the cooktop. If you do flame foods under the hood, turn the fan on.
- Do not use a wok on the cooking surface if the wok has a round metal ring that is placed over the burner grate to support the wok. This ring acts as a heat trap, which may damage the burner grate and burner head. Also, it may cause the burner to work improperly. This may cause a carbon monoxide level above that allowed by current standards, resulting in a health hazard.
- Foods for frying should be as dry as possible. Frost on frozen foods or moisture on fresh foods can cause hot fat to bubble up and over the sides of the pan.
- Never try to move a pan of hot fat, especially a deep fat fryer. Wait until the fat is cool.
- Do not leave plastic items on the cooktop—they may melt if left too close to the vent.
- Keep all plastics away from the surface burners.
- To avoid the possibility of a burn, always be certain that the controls for all burners are at the **OFF** position and all grates are cool before attempting to remove them.
- If range is located near a window, do not hang long curtains that could blow over the surface burners and create a fire hazard.
- If you smell gas, turn off the gas to the range and call a qualified service technician. Never use an open flame to locate a leak.
- Always turn the surface burner controls off before removing cookware.
- Do not lift the cooktop on sealed burner models. Lifting the cooktop can lead to damage and improper operation of the range.



# IMPORTANT SAFETY INFORMATION.

## READ ALL INSTRUCTIONS BEFORE USING.



### COOK MEAT AND POULTRY THOROUGHLY...

Cook meat and poultry thoroughly—meat to at least an *INTERNAL* temperature of 160°F and poultry to at least an *INTERNAL* temperature of 180°F. Cooking to these temperatures usually protects against foodborne illness.



### OVEN

Stand away from the range when opening the door of a hot oven. The hot air and steam that escape can cause burns to hands, face and eyes.

- Do not use the oven for a storage area. Items stored in the oven can ignite.
- Keep the oven free from grease buildup.
- Place the oven racks in the desired position while the oven is cool.
- Pulling out the rack to the stop-lock is a convenience in lifting heavy foods. It is also a precaution against burns from touching hot surfaces of the door or oven walls. The lowest position is not designed to slide.
- Do not heat unopened food containers. Pressure could build up and the container could burst, causing an injury.
- When using cooking or roasting bags in the oven, follow the manufacturer's directions.
- Do not use your oven to dry newspapers. If overheated, they can catch fire.
- Use only glass cookware that is recommended for use in gas ovens.
- Always remove any broiler pan from range as soon as you finish broiling. Grease left in the pan can catch fire if oven is used without removing the grease from the broiler pan.
- When broiling, if meat is too close to the flame, the fat may ignite. Trim excess fat to prevent excessive flare-ups.

**⚠ WARNING: NEVER** cover any slots, holes or passages in the oven bottom or cover an entire rack with materials such as aluminum foil. Doing so blocks air flow through the oven and may cause carbon monoxide poisoning. Aluminum foil linings may also trap heat, causing a fire hazard.

- Make sure any broiler pan is in place correctly to reduce the possibility of grease fires.
- If you should have a grease fire in a broiler pan, touch the **Clear/Off** pad, and keep the oven door closed to contain fire until it burns out.
- For safety and proper cooking performance, always bake and broil with the oven door closed.

- Do not use aluminum foil anywhere in the oven except as described in this manual. Misuse could result in a fire hazard or damage to the range.



## ELECTRIC WARMING DRAWER (on some models)

- The purpose of the warming drawer is to hold hot cooked foods at serving temperature. Always start with hot food; cold food cannot be heated or cooked in the warming drawer.
- Do not use the warming drawer to dry newspapers. If overheated, they can catch on fire.
- Do not leave paper products, cooking utensils or food in the warming drawer when not in use.
- Never leave jars or cans of fat drippings in or near your warming drawer.
- Always keep wooden and plastic utensils and canned food a safe distance away from your warming drawer.
- Do not warm food in the warming drawer for more than two hours.
- **Do not touch the heating element or the interior surface of the warming drawer.** These surfaces may be hot enough to burn.  
**REMEMBER:** The inside surface of the warming drawer may be hot when the drawer is opened.
- Use care when opening the drawer. Open the drawer a crack and let hot air or steam escape before removing or replacing food. Hot air or steam which escapes can cause burns to hands, face and/or eyes.
- Do not use aluminum foil to line the drawer. Foil is an excellent heat insulator and will trap heat beneath it. This will upset the performance of the drawer and it could damage the interior finish.



## SELF-CLEANING OVEN

- Be sure to wipe off excess spillage before self-cleaning operation.
- Before self-cleaning the oven, remove the racks, any broiler pan, grid and other cookware.
- Do not clean the door gasket. The door gasket is essential for a good seal. Care should be taken not to rub, damage or move the gasket.
- Clean only parts listed in this Owner's Manual.
- If the self-cleaning mode malfunctions, turn the oven off and disconnect the power supply. Have it serviced by a qualified technician.
- Do not use oven cleaners. No commercial oven cleaner or oven liner of any kind should be used in or around any part of the oven. Residue from oven cleaners will damage the inside of the oven when the self-clean cycle is used.



**READ AND FOLLOW THIS SAFETY INFORMATION CAREFULLY.  
SAVE THESE INSTRUCTIONS**

## Using the gas surface burners.

Throughout this manual, features and appearance may vary from your model.

### Before Lighting a Gas Burner

- Drip pans are supplied with your range; they should be used at all times.
- Make sure all burners are in place.
- Make sure all grates on the range are properly placed before using any burner.

### After Lighting a Gas Burner

- Do not operate the burner for an extended period of time without cookware on the grate. The finish on the grate may chip without cookware to absorb the heat.
- Be sure the burners and grates are cool before you place your hand, a pot holder, cleaning cloths or other materials on them.

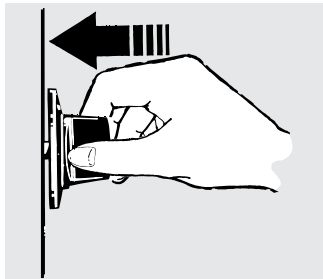

Push the control knob in and turn it to the **LITE** position.

### How to Light a Gas Surface Burner

Make sure all the surface burners are placed in their respective positions.

Push the control knob in and turn it to the **LITE** position.

You will hear a little **clicking** noise—the sound of the electric spark igniting the burner.

Turn the knob to adjust the flame size. If the knob stays at **LITE**, it will continue to click.

When one burner is turned to **LITE**, all the burners spark. Do not attempt to disassemble or clean around any burner while another burner is on. An electric shock may result, which could cause you to knock over hot cookware.

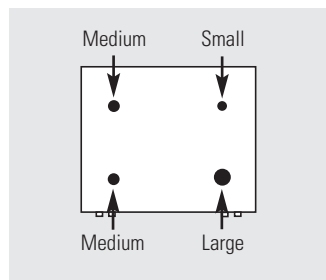

On some models

### Sealed Gas Burners

Your gas range cooktop has four sealed gas burners. They offer convenience and flexibility to be used in a wide range of cooking applications.

The smallest burner in the right rear position is the simmer burner. This burner can be turned down to a very low simmer setting. It provides precise cooking performance for delicate foods such as sauces or foods that require low heat for a long cooking time.

The medium (left rear and, on some models, left front) and the large (right front and, on some models, left front) burners are the primary burners for most cooking. These general-purpose burners can be turned down from **HI** to **LO** to suit a wide range of cooking needs.

**NOTE:** On some models, the burners are all the same size and power.

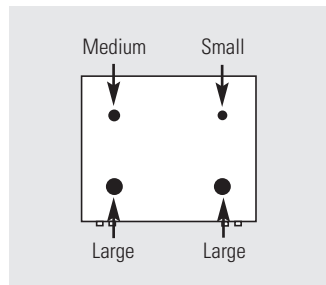

On some models

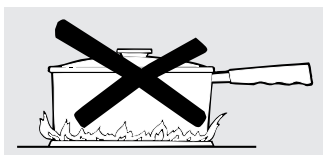

### How to Select Flame Size

For safe handling of cookware, never let the flames extend up the sides of the cookware.

Watch the flame, not the knob, as you reduce heat. When fast heating is desired, the flame size on a gas burner should match the cookware you are using.

Flames larger than the bottom of the cookware will not result in faster heating of the cookware and could be hazardous.



### Top-of-Range Cookware

**Aluminum:** Medium-weight cookware is recommended because it heats quickly and evenly. Most foods brown evenly in an aluminum skillet. Use saucepans with tight-fitting lids when cooking with minimum amounts of water.

**Cast-Iron:** If heated slowly, most skillets will give satisfactory results.

**Enamelware:** Under some conditions, the enamel of some cookware may melt. Follow cookware manufacturer's recommendations for cooking methods.

**Glass:** There are two types of glass cookware—those for oven use only and those for top-of-range cooking (saucepans, coffee and teapots). Glass conducts heat very slowly.

**Heatproof Glass-Ceramic:** Can be used for either surface or oven cooking. It conducts heat very slowly and cools very slowly. Check cookware manufacturer's directions to be sure it can be used on gas ranges.

**Stainless Steel:** This metal alone has poor heating properties and is usually combined with copper, aluminum or other metals for improved heat distribution. Combination metal skillets usually work satisfactorily if they are used with medium heat as the manufacturer recommends.



### Stove Top Grills *(on models with sealed burners)*

Do not use stove top grills on your sealed gas burners. If you use the stove top grill on the sealed gas burner, it will cause incomplete combustion and can result in exposure to carbon monoxide levels above allowable current standards.

*This can be hazardous to your health.*

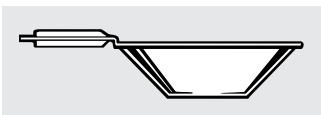

Use a flat-bottomed wok.

### Wok This Way *(on models with sealed burners)*

We recommend that you use a 14" or smaller flat-bottomed wok. Make sure the wok bottom sits flat on the grate. They are available at your local retail store.

Only a flat-bottomed wok should be used.

Do not use a flat-bottomed wok on a support ring. Placing the ring over the burner or grate may cause the burner to work improperly, resulting in carbon monoxide levels above allowable standards. This could be dangerous to your health.



### In Case of Power Failure

In case of a power failure, you can light the gas surface burners on your range with a match. Hold a lit match to the burner, then push in and turn the control knob to the **LITE** position. Use extreme caution when lighting burners this way.

Surface burners in use when an electrical power failure occurs will continue to operate normally.

# Using the oven controls.

Throughout this manual, features and appearance may vary from your model.

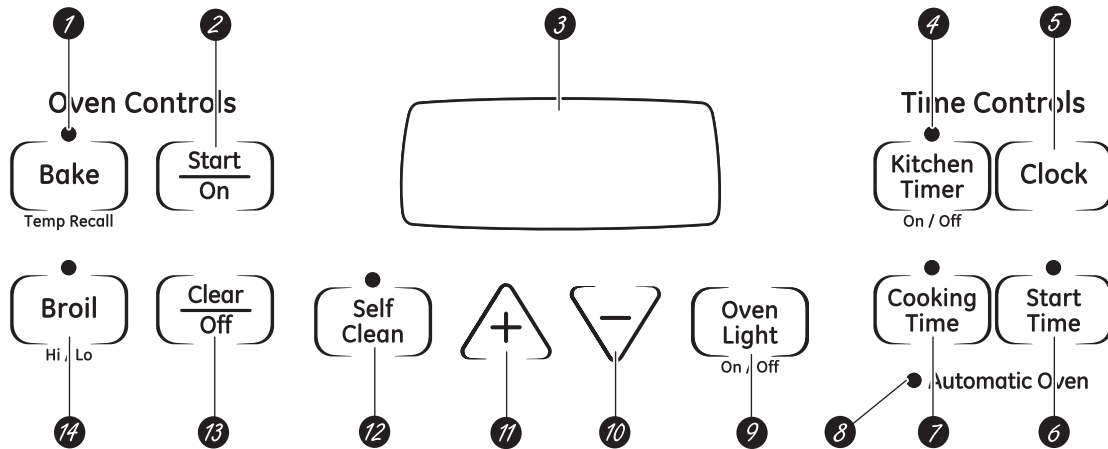

## Oven Control, Clock and Timer Features and Settings (on some models)

- 1** **Bake/Temp Recall Pad**  
Touch this pad to select the bake function.

**Bake Light**  
Flashes while in edit mode—you can change the oven temperature at this point. Glows when the oven is in bake mode.
- 2** **Start/On Pad**  
Must be touched to start any cooking or cleaning function.
- 3** **Display**  
Shows the time of day, oven temperature, whether the oven is in the bake, broil or self-cleaning mode and the times set for the timer or automatic oven operations. The display will show **PRE** while preheating. When the oven reaches the selected temperature, the oven control will beep and the display will show the oven temperature.

*If "F-" and a number or letter flash in the display and the oven control signals, this indicates a function error code.*

*If your oven was set for a timed oven operation and a power outage occurred, the clock and all programmed functions must be reset.*

*The time of day will flash in the display when there has been a power outage. Reset the clock.*

*If the function error code appears during the self-cleaning cycle, check the oven door latch. The latch handle may have been moved, even if only slightly, from the latched position. Make sure the latch is moved to the right as far as it will go.*

**Touch the Clear/Off pad.** Allow the oven to cool for one hour. Put the oven back into operation. If the function error code repeats, disconnect the power to the range and call for service.
- 4** **Kitchen Timer On/Off Pad**  
Touch this pad to select the timer feature. Then press the + and – pads to adjust the timer.

**Timer Light**  
Flashes while in edit mode—you can change the set time at this point. Glows when the timer has been activated. Flashes again when the time has run out until the control is reset.
- 5** **Clock Pad**  
To set the clock, press this pad twice and then press the + and – pads. The time of day will flash in the display when the oven is first turned on.
- 6** **Start Time Pad (on some models)**  
Use along with the **Cooking Time** or **Self Clean** pads to set the oven to start and stop automatically at a time you set.

**Start Time Light**  
Flashes while in edit mode—you can change the start time at this point. Glows when the function has been activated.
- 7** **Cooking Time Pad (on some models)**  
Touch this pad and then touch the + or – pads to set the amount of time you want your food to cook. The oven will shut off when the cooking time has run out.

**Cooking Time Light**  
Flashes while in edit mode—you can change the set time at this point. Glows when the function has been activated. Flashes again when the time has run out until the control is reset.



## Oven Control, Clock and Timer Features and Settings *(on some models)*

### 8 Automatic Oven Light *(on some models)*

This lights anytime the oven has been programmed using the **Cooking Time** or **Start Time** functions.

### 9 Oven Light On/Off Pad

Touch this pad to turn the oven light on or off.

### 10 - Pad

Short taps to this pad will decrease the time or temperature by small amounts. Touch and hold the pad to decrease the time or temperature by larger amounts.

### 11 + Pad

Short taps to this pad will increase the time or temperature by small amounts. Touch and hold the pad to increase the time or temperature by larger amounts.

### 12 Self Clean Pad

Touch this pad to select the self-cleaning function. See the *Using the self-cleaning oven* section.

#### Clean Light

Flashes while in edit mode—you can change the length of time for the self-clean cycle at this point. Glows when the oven is in the self-clean cycle. After the self-clean cycle, the light will turn off. Unlatch the door.

### 13 Clear/Off Pad

Touch this pad to cancel **ALL** oven operations except the clock and timer.

### 14 Broil Hi/Lo Pad

Touch this pad to select the broil function.

#### Broil Light

Flashes while in edit mode—you can switch from **Hi** to **Lo Broil** at this point. Glows when the oven is in broil mode.

#### Indicator Lights *(on some pads)*

**EDIT** mode lasts several seconds after the last pad press. **Start Time** and **Cooking Time** will be the only pads lit if either of these options is selected. (Example: **Start Time** is selected with **Bake**—the **Start Time** pad will remain lit until the clock reaches the programmed time, at which point it will turn off and the **Bake/Temp Recall** pad light will light up.)



## Oven Temperature Knob *(on some models)*

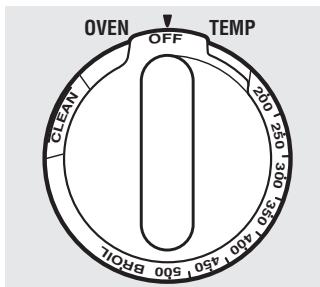

Appearance may vary.

Turn the **OVEN TEMP** knob to the setting you want.

- The oven cycling light comes on during cooking.

## Using the oven.

To avoid possible burns, place the racks in the desired position before you turn the oven on.

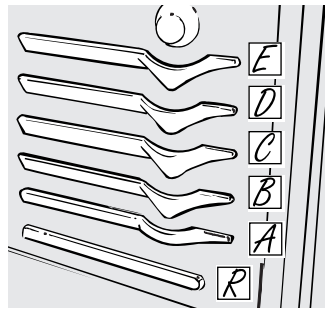

The oven has 5 rack positions.

It also has a special low rack position (R) for extra large items, such as a large turkey.

### Before you begin...

The racks have stop-locks, so that when placed correctly on the rack supports (A through E), they will stop before coming completely out, and will not tilt.

When placing and removing cookware, pull the rack out to the bump on the rack support.

**To remove a rack,** pull it toward you, tilt the front end up and pull it out.

**To replace,** place the end of the rack (stop-locks) on the support, tilt up the front and push the rack in.

**NOTE:** The rack is not designed to slide out at the special low rack (R) position.

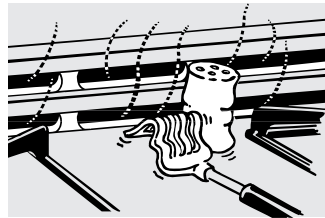

Plastic items on the cooktop may melt if left too close to the vent.

Vent appearance and location vary.

### Oven Vent

Your oven is vented through ducts at the rear of the range. Do not block these ducts when cooking in the oven—it is important that the flow of hot air from the oven and fresh air to the oven burner be uninterrupted. Avoid touching the vent openings or nearby surfaces during oven or broiler operation—they may become hot.

- Handles of pots and pans on the cooktop may become hot if left too close to the vent.
- Do not leave plastic or flammable items on the cooktop—they may melt or ignite if left too close to the vent.
- Do not leave closed containers on the cooktop. The pressure in closed containers may increase, which may cause them to burst.
- Metal items will become very hot if they are left on the cooktop, and could cause burns.

### Power Outage

**▲ CAUTION:** Do not make any attempt to operate the electric ignition oven during an electrical power failure.

The oven or broiler cannot be lit during a power failure. Gas will not flow unless the glow bar is hot.

If the oven is in use when a power failure occurs, the oven burner shuts off and cannot be relit until power is restored. This is because the flow of gas is automatically stopped and will not resume when power is restored until the glow bar has reached operating temperature.

### Oven Light (on some models)

Touch the **Oven Light On/Off** pad on the upper control panel to turn the light on or off.

### Oven Light (on some models)

Press the **Oven Light On/Off** pad on the lower control panel to turn the light on or off.

# Using the upper oven.

If your model has a door latch, do not lock the oven door with the latch during baking or roasting. The latch is used for self-cleaning only.



The oven has a special low rack (R) position just above the oven bottom. Use it when extra cooking space is needed, for example, when cooking a large turkey. The rack is not designed to slide out at this position.

## How to Set the Upper Oven for Baking or Roasting

Your oven is not designed for open-door cooking.

- 1 Touch the **BAKE** pad.
- 2 Touch the number pads to set the desired temperature.
- 3 Touch the **START** pad.

The word **ON** and **100°** will be displayed. As the oven heats up, the display will show the changing temperature. When the oven reaches the temperature you set, a tone will sound.

To change the oven temperature during **BAKE** cycle, press the **BAKE** pad and then the number pads to get the new temperature.

- 4 Check food for doneness at minimum time on recipe. Cook longer if necessary.
- 5 Touch the **CLEAR/OFF** pad when cooking is complete.

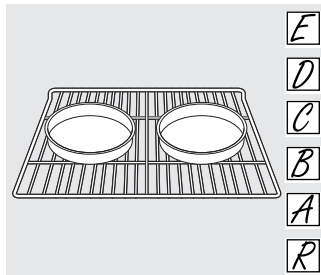

When baking on a single rack, use the rack position from the chart for your type of food. Baking results will be better if baking pans are centered in the oven as much as possible.

## Preheating and Pan Placement

Preheat the oven if the recipe calls for it. To preheat, set the oven at the correct temperature. Preheating is necessary when convection baking and for good results when baking cakes, cookies, pastry and breads.

Baking results will be better if foods are centered in the oven as much as possible. Pans should not touch each other or the walls of the oven.

For best results when baking four cake layers at a time, use racks B and D. Place the lower pans at the back of the rack and the upper pans at the front of the rack as shown so that one pan is not directly above another leaving approximately 1-1/2" between pans, from the front, back and sides of the walls.

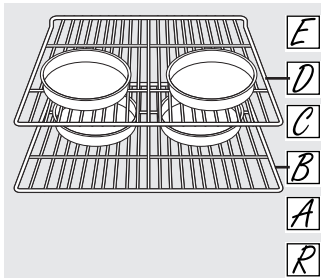

When baking four cake layers at a time, use racks B and D. Place the lower pans at the back of the rack and the upper pans to the front of the rack shown so that one pan is not directly above another.

Type of Food	Rack Position
Angel food cake	A or C
Bundt or pound cakes	A or C
Biscuits, muffins, brownies, cookies, cupcakes, layer cakes, pies	C
Casseroles	B or C
Pies – On cookie sheet	B or C
Roasting	R or A
4-Layer cakes	B & D

## Aluminum Foil

Do not use aluminum foil on the bottom of the oven.

Never entirely cover a rack with aluminum foil. This will disturb the heat circulation and result in poor baking.

A smaller sheet of foil may be used to catch a spillover by placing it on a lower rack several inches below the food.

## Oven Moisture

As your oven heats up, the temperature change of the air in the oven may cause water droplets to form on the door glass.

These droplets are harmless and will evaporate as the oven continues to heat up.



## Using the oven.

Do not lock the oven door with the latch during broiling. The latch is used for self-cleaning only.

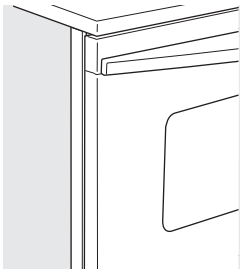

Close the door. **Always broil with the door closed.**

### How to Set the Oven for Broiling

**NOTE:** On models with an **OVEN TEMP** knob, turn it to **BROIL**.

- 1 Place the meat or fish on a broiler grid in a broiler pan.
- 2 Follow suggested rack positions in the *Broiling Guide*.
- 3 The oven door **must** be closed during broiling.
- 4 Touch the **Broil Hi/Lo** pad once for **Hi Broil**.

To change to **Lo Broil**, touch the **Broil Hi/Lo** pad again.

- 5 Touch the **Start/On** pad.
- 6 When broiling is finished, touch the **Clear/Off** pad.

Serve the food immediately, and leave the pan outside the oven to cool during the meal for easiest cleaning.

Use **Lo Broil** to cook foods such as poultry or thick cuts of meat thoroughly without overbrowning them.

The size, weight, thickness, starting temperature and your preference of doneness will affect broiling times. This guide is based on meats at refrigerator temperature.

*†The U.S. Department of Agriculture says "Rare beef is popular, but you should know that cooking it to only 140°F means some food poisoning organisms may survive." (Source: Safe Food Book, Your Kitchen Guide, USDA Rev. June 1985.)*

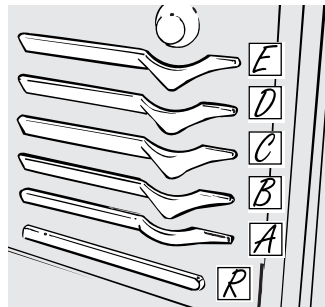

The oven has 5 rack positions.

### Broiling Guide

Food	Quantity and/or Thickness	Rack* Position	First Side Time (min.)	Second Side Time (min.)	Comments
<b>Bacon</b>	1/2 lb. (about 8 thin slices)	C	4	3	Arrange in single layer.
<b>Ground Beef</b> Well Done	1 lb. (4 patties) 1/2 to 3/4" thick	C	10	7-10	Space evenly. Up to 8 patties take about the same time.
<b>Beef Steaks</b>					
Rare†	1" thick	C	9	7	Steaks less than 1" thick cook through before browning. Pan frying is recommended. Slash fat.
Medium	1 to 1½ lbs.	C	12	5-6	
Well Done		C	13	8-9	
Rare†	1½" thick	C	10	6-7	
Medium	2 to 2½ lbs.	C	12-15	10-12	
Well Done		C	25	16-18	
<b>Chicken</b>	1 whole 2 to 2½ lbs., split lengthwise 4 bone-in breasts	B	30-35	15-20	Brush each side with melted butter. Broil skin-side-down first.
<b>Lobster Tails</b>	2-4 6 to 8 oz. each	C	13-16	Do not turn over.	Cut through back of shell. Spread open. Brush with melted butter before broiling and after half of broiling time.
<b>Fish Fillets</b>	1/4 to 1/2" thick	D	6	6	Handle and turn very carefully. Brush with lemon butter before and during cooking, if desired. Preheat broiler to increase browning.
<b>Ham Slices</b> (precooked)	1" thick	C	8	8	
	1/2" thick	D	6	6	
<b>Pork Chops</b> Well Done	2 (1½" thick)	D	10	8	Slash fat.
	2 (1" thick) about 1 lb.	D	15	8	
<b>Lamb Chops</b>					
Medium	2 (1" thick) about 10 to 12 oz.	D	8	4-7	Slash fat.
Well Done		D	10	10	
Medium	2 (1½" thick) about 1 lb.	D	10	4-6	
Well Done		D	17	12-14	

\*See illustration for description of rack positions.



Not all features are on all models.

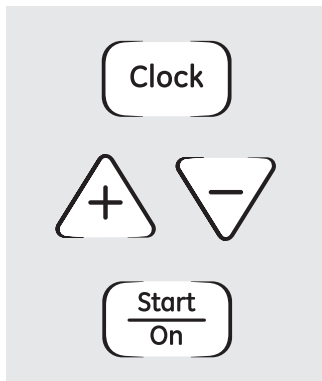

Make sure the clock is set to the correct time of day.

## To Set the Clock

The clock must be set to the correct time of day for the automatic oven timing functions to work properly. The time of day cannot be changed during a delayed cooking or a delayed self-cleaning cycle.

- 1 Touch the **Clock** pad twice.
- 2 Touch the + or - pads.

If the + or - pads are not touched within one minute after you touch the **Clock** pad, the display reverts to the original setting. If this happens, touch the **Clock** pad twice and reenter the time of day.

- 3 Touch the **Start/On** pad until the time of day shows in the display. This enters the time and starts the clock.

*To check the time of day when the display is showing other information, simply touch the **Clock** pad. The time of day shows until another pad is touched.*

## To Turn Off the Clock Display

If you have several clocks in your kitchen, you may wish to turn off the time of day clock display on your range.

- 1 Touch the **Clock** pad once to turn off the time of day display. Although you will not be able to see it, the clock maintains the correct time of day.

- 2 Touch the **Clock** pad twice to recall the clock display.

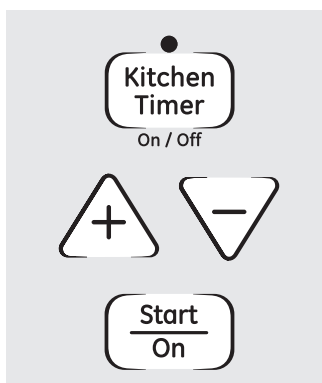

The timer is a minute timer only. The **Clear/Off** pad does not affect the timer.

## To Set the Timer

*The timer does not control oven operations. The maximum setting on the timer is 9 hours and 59 minutes.*

- 1 Touch the **Kitchen Timer On/Off** pad.
- 2 Touch the + or - pads until the amount of time you want shows in the display. The maximum time that can be entered in minutes is 59. Times more than 59 minutes should be changed to hours and minutes.

- 3 Touch the **Start/On** pad. The time will start counting down, although the display does not change until one minute has passed.

- 4 When the timer reaches :00, the control will beep 3 times followed by one beep every 6 seconds until the **Kitchen Timer On/Off** pad is touched.

*If you make a mistake, touch the **Kitchen Timer On/Off** pad and begin again.*

## Using the clock and timer. *(on some models)*

Not all features are on all models.

### To Reset the Timer

If the display is still showing the time remaining, you may change it by touching the **Kitchen Timer On/Off** pad and then touching the + or - pads until the time you want appears in the display.

If the remaining time is not in the display (clock, start time or cooking time are in the display), recall the remaining time by touching the **Kitchen Timer On/Off** pad and then touching the + or - pads to enter the new time you want.

### To Cancel the Timer

Touch the **Kitchen Timer On/Off** pad twice.

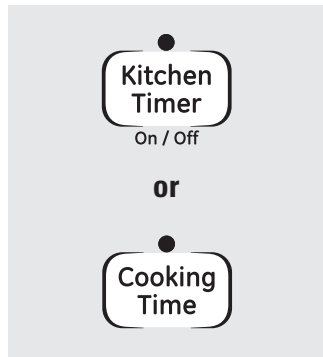

### End of Cycle Tones *(on some models)*

Clear the tones by pressing the pad of the function you are using.

### Power Outage

*If a flashing time is in the display, you have experienced a power failure. Reset the clock.*

To reset the clock, touch the **Clock** pad. Enter the correct time of day by touching the + or - pads. Touch the **Start/On** pad.

# Using the timed baking and roasting features. (on some models) [GEAppliances.com](http://GEAppliances.com)

Do not lock the oven door with the latch during timed cooking. The latch is used for self-cleaning only.

**NOTE:** Foods that spoil easily—such as milk, eggs, fish, stuffings, poultry and pork—should not be allowed to sit for more than 1 hour before or after cooking. Room temperature promotes the growth of harmful bacteria. Be sure that the oven light is off because heat from the bulb will speed harmful bacteria growth.

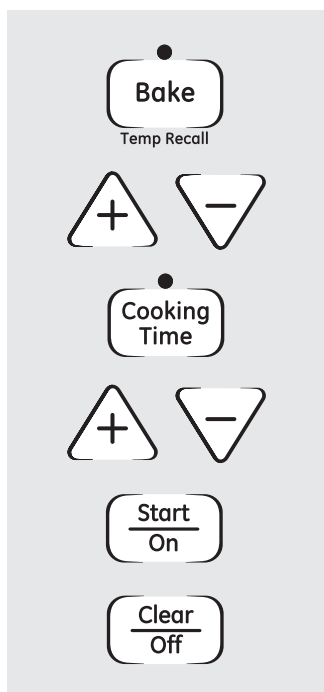

## How to Set an Immediate Start and Automatic Stop

The oven will turn on immediately and cook for a selected length of time. At the end of the cooking time, the oven will turn off automatically.

- 1 Touch the **Bake** pad.
- 2 Touch the **+** or **-** pads to set the oven temperature.
- 3 Touch the **Cooking Time** pad.

**NOTE:** If your recipe requires preheating, you may need to add additional time to the length of the cooking time.

- 4 Touch the **+** or **-** pads to set the baking time.

The cooking time that you entered will be displayed. (If you select Cooking Time first and then adjust the Bake Temperature, the oven temperature will be displayed instead.)

- 5 Touch the **Start/On** pad.

The display shows either the oven temperature that you set or the cooking time countdown. (The display starts with **PRE** if showing the oven temperature.)

The oven will continue to cook for the programmed amount of time, then turn off automatically.

- 6 Touch the **Clear/Off** pad to clear the display if necessary.

Remove the food from the oven. Remember, even though the oven shuts off automatically, foods continue cooking after controls are off.

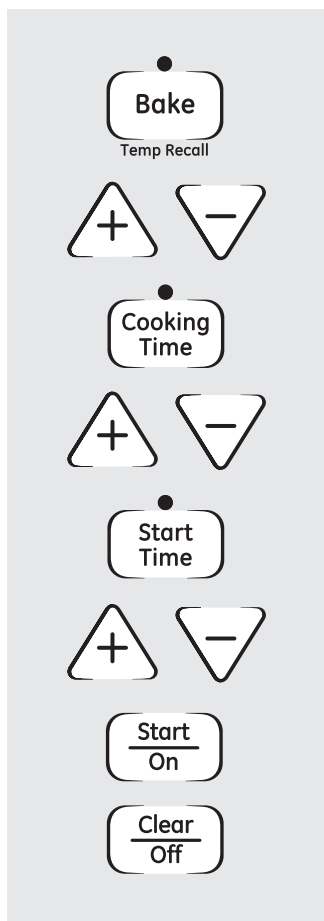

## How to Set a Delayed Start and Automatic Stop

The oven will turn on at the time of day you set, cook for a specific length of time and then turn off automatically.

Make sure the clock shows the correct time of day.

- 1 Touch the **Bake** pad.
- 2 Touch the **+** or **-** pads to set the oven temperature.
- 3 Touch the **Cooking Time** pad.
- 4 Touch the **+** or **-** pads to set the desired length of cooking time.
- 5 Touch the **Start Time** pad.
- 6 Touch the **+** or **-** pads to set the time of day you want the oven to turn on and start cooking.
- 7 Touch the **Start/On** pad.

**NOTE:** An attention tone will sound if you are using timed baking and do not touch the **Start/On** pad.

**NOTE:** If you would like to check the times you have set, touch the **Start Time** pad to check the start time you have set or touch the **Cooking Time** pad to check the length of cooking time you have set.

When the oven turns on at the time of day you have set, the display will show **PRE** until it reaches the selected temperature, and then it will display the oven temperature.

At the end of cooking time, the oven will turn off and the end of cycle tone will sound.

- 8 Touch the **Clear/Off** pad to clear the display if necessary.

Remove the food from the oven. Remember, even though the oven shuts off automatically, foods continue cooking after controls are off.

## Special features of your oven control. *(on some models)*

Your new touch pad control has additional features that you may choose to use. The following are the features and how you may activate them.

The special feature modes can only be activated while the display is showing the time of day. They remain in the control's memory until the steps are repeated.

When the display shows your choice, touch the **Start/On** pad. The special features will remain in memory after a power failure.

**NOTE:** The Sabbath feature and the Thermostat Adjustment feature are also Special Features, but they are addressed separately in the following sections.

### 12 Hour Shut-Off

With this feature, should you forget and leave the oven on, the control will automatically turn off the oven after 12 hours during baking functions or after 3 hours during a broil function.

If you wish to turn **OFF** this feature, follow the steps below.

- 1 Touch the **Bake** and **Broil Hi/Lo** pads at the same time for 3 seconds until the display shows **SF**.

- 2 Touch the **Clock** pad. The display will show **ON** (12 hour shut-off). Touch the **Clock** pad repeatedly until the display shows **OFF** (no shut-off).
- 3 Touch the **Start/On** pad to activate the no shut-off and leave the control set in this special features mode.

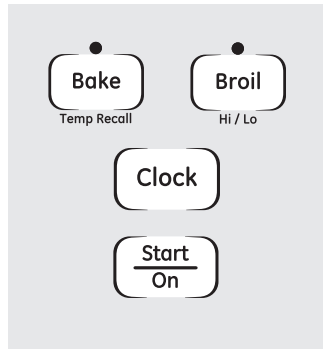

# Using the Sabbath feature. (on some models)

(Designed for use on the Jewish Sabbath and Holidays)

GEAppliances.com

The Sabbath feature can be used for baking/roasting only. It cannot be used for broiling, self-cleaning or delay start cooking.

**NOTE:** The oven light comes on automatically (on some models) when the door is opened and goes off when the door is closed. The bulb may be removed. See the Oven Light Replacement section. On models with a light switch on the control panel, the oven light may be turned on and left on.

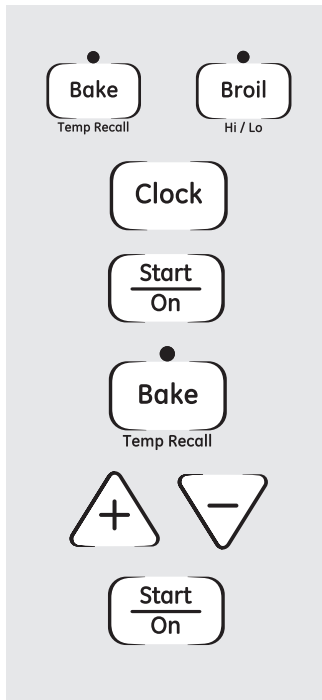

When the display shows  $\square$  the oven is set in Sabbath. When the display shows  $\square$  the oven is baking/roasting.

## How to Set for Regular Baking/Roasting

**NOTE:** To understand how the oven control works, practice using regular baking (non-Sabbath) before entering Sabbath mode.

Make sure the clock shows the correct time of day and the oven is off.

- 1 Touch and hold **both** the **Bake** and **Broil Hi/Lo** pads, **at the same time**, until the display shows **SF**.
- 2 Tap the **Clock** pad until **SAb** appears in the display.
- 3 Touch the **Start/On** pad and  $\square$  will appear in the display.
- 4 Touch the **Bake** pad. No signal will be given.
- 5 The preset starting temperature will automatically be set to 350°. Tap the + or - pads to increase or decrease the temperature in 25° increments. The temperature can be set between 170° and 550°. No signal or temperature will be given.

- 6 Touch the **Start/On** pad.
- 7 After a random delay period of approximately 30 seconds to 1 minute,  $\square$  will appear in the display indicating that the oven is baking/roasting. If  $\square$  doesn't appear in the display, start again at Step 4.

To adjust the oven temperature, touch the **Bake** pad and tap the + or - pads to increase or decrease the temperature in 25° increments. Touch the **Start/On** pad.

**NOTE:** The **Clear/Off** and **Cooking Time** pads are active during the Sabbath feature.

## How to Set for Timed Baking/Roasting—Immediate Start and Automatic Stop

**NOTE:** To understand how the oven control works, practice using regular (non-Sabbath) Immediate Start and Automatic Stop before entering the Sabbath mode.

Make sure the clock shows the correct time of day and the oven is off.

- 1 Touch and hold **both** the **Bake** and **Broil Hi/Lo** pads, **at the same time**, until the display shows **SF**.
- 2 Tap the **Clock** pad until **SAb** appears in the display.
- 3 Touch the **Start/On** pad and  $\square$  will appear in the display.
- 4 Touch the **Cooking Time** pad.
- 5 Touch the + or - pads to set the desired length of cooking time between 1 minute and 9 hours and 59 minutes. The cooking time that you entered will be displayed.
- 6 Touch the **Start/On** pad.
- 7 Touch the **Bake** pad. No signal will be given.

- 8 The preset starting temperature will automatically be set to 350°. Tap the + or - pads to increase or decrease the temperature in 25° increments. The temperature can be set between 170° and 550°. No signal or temperature will be given.

- 9 Touch the **Start/On** pad.
- 10 After a random delay period of approximately 30 seconds to 1 minute,  $\square$  will appear in the display indicating that the oven is baking/roasting. If  $\square$  doesn't appear in the display, start again at Step 7.

To adjust the oven temperature, touch the **Bake** pad and tap the + or - pads to increase or decrease the temperature in 25° increments. Touch the **Start/On** pad.

When cooking is finished, the display will change from  $\square$  to  $\square$ , indicating that the oven has turned **OFF** but is still set in Sabbath. Remove the cooked food.

When the display shows  $\square$  the oven is set in Sabbath. When the display shows  $\square$  the oven is baking/roasting.

## Using the Sabbath feature. (on some models)

(Designed for use on the Jewish Sabbath and Holidays)

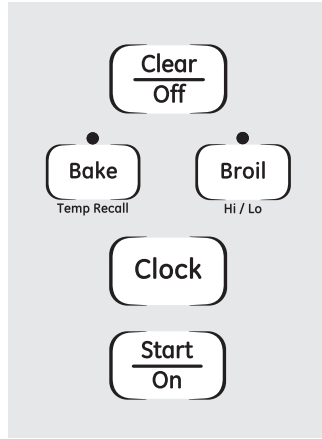

### How to Exit the Sabbath Feature

- 1 Touch the **Clear/Off** pad.
- 2 If the oven is cooking, wait for a random delay period of approximately 30 seconds to 1 minute, until only  $\square$  is in the display.
- 3 Touch and hold **both** the **Bake** and **Broil Hi/Lo** pads, **at the same time**, until the display shows **SF**.
- 4 Tap the **Clock** pad until **ON** or **OFF** appears in the display. **ON** indicates that the oven will automatically turn off after 12 hours. **OFF** indicates that the oven will not automatically turn off. See the *Special features* section for an explanation of the *12 Hour Shut-Off* feature.
- 5 Touch the **Start/On** pad.

**NOTE:** If a power outage occurred while the oven was in Sabbath, the oven will automatically turn off and stay off even when the power returns. The oven control must be reset.



# Adjust the oven thermostat—Do it yourself!

GEAppliances.com

You may find that your new oven cooks differently than the one it replaced. Use your new oven for a few weeks to become more familiar with it. If you still think your new oven is too hot or too cold, you can adjust the thermostat yourself.

Do not use thermometers, such as those found in grocery stores, to check the temperature setting of your oven. These thermometers may vary 20–40 degrees.

**NOTE:** This adjustment will not affect the broiling or the self-cleaning temperatures. The adjustment will be retained in memory after a power failure.

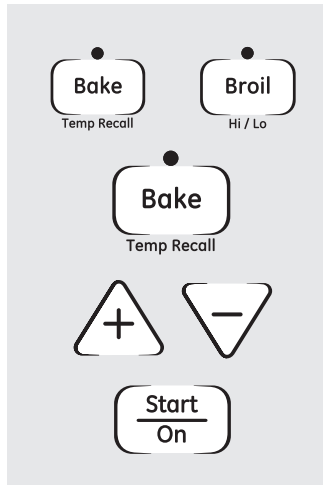

## To Adjust the Thermostat (on some models)

- 1 Touch the **Bake** and **Broil Hi/Lo** pads at the same time for 3 seconds until the display shows **SF**.
- 2 Touch the **Bake** pad. A two-digit number shows in the display.
- 3 The oven temperature can be adjusted up to (+) 35°F hotter or (-) 35°F cooler. Touch the **+** pad to increase the temperature in 1-degree increments. Touch the **-** pad to decrease the temperature in 1-degree increments.
- 4 When you have made the adjustment, touch the **Start/On** pad to go back to the time-of-day display. Use your oven as you would normally.

**NOTE:** This adjustment will not affect the broiling or self-cleaning temperatures. It will be retained in memory after a power failure.

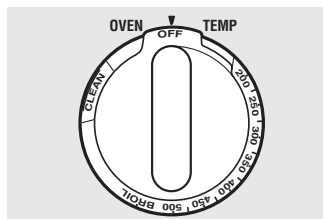

Front of OVEN TEMP knob  
(knob appearance may vary)

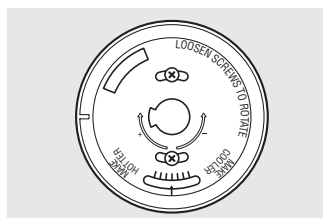

Back of OVEN TEMP knob  
(knob appearance may vary)

## To Adjust the Thermostat (on models with an OVEN TEMP Knob)

- 1 **Pull the OVEN TEMP knob off the range and look at the back side.** To make an adjustment, loosen (approximately one turn), but do not completely remove, the two screws on the back of the knob.
- 2 With the back of the knob facing you, hold the outer edge of the knob with one hand and turn the front of the knob with the other hand.  
**To increase** the oven temperature, move the top screw toward the right. You'll hear a click for each notch you move the knob.  
**To decrease** the oven temperature, move the top screw toward the left.
- 3 **After the adjustment is made,** retighten screws so they are snug, but be careful not to overtighten.
- 4 Replace the knob, matching the flat area of the knob to the shaft, and check performance.

Each click will change the oven temperature approximately 10°F. (Range is plus or minus 60°F from the arrow.) We suggest that you make the adjustment one click from the original setting and check oven performance before making any additional adjustments.

# The type of margarine will affect baking performance!

Most recipes for baking have been developed using high-fat products such as butter or margarine (80% fat). If you decrease the fat, the recipe may not give the same results as with a higher-fat product.

Recipe failure can result if cakes, pies, pastries, cookies or candies are made with low-fat spreads. The lower the fat content of a spread product, the more noticeable these differences become.

Federal standards require products labeled "margarine" to contain at least 80% fat by weight. Low-fat spreads, on the other hand, contain less fat and more water. The high moisture content of these spreads affects the texture and flavor of baked goods. For best results with your old favorite recipes, use margarine, butter or stick spreads containing at least 70% vegetable oil.

Safety Instructions

Operating Instructions

Care and Cleaning

Installation Instructions

Troubleshooting Tips

Consumer Support

## Using the warming drawer. *(on some models)*

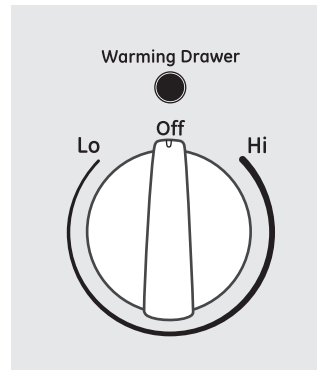

### Control Knob *(on models equipped with a knob)*

Push and turn the control knob to any desired setting.

**NOTE:** The warming drawer should not be used during a self-clean cycle.

<b>Lo</b> .....	Pies
<b>Medium</b> (midposition on the knob) .....	Casseroles
<b>Hi</b> .....	Meats

### On Signal Light

The **On** signal light is located above the control knob and glows when the knob is in the on position. It stays on until the knob is moved to the **Off** position.

### When Using the Warming Drawer

The warming drawer will keep hot, cooked foods at serving temperature. **Always start with hot food.** Do not use to heat cold food other than crisping crackers, chips or dry cereal.

**Do not line the warming drawer with aluminum foil. Foil is an excellent heat insulator and will trap heat beneath it. This will upset the performance of the drawer and could damage the interior finish.**

■ Preheat prior to use according to these recommended times:

<b>Setting Lo</b> .....	15 minutes
<b>Setting Medium</b> .....	25 minutes
<b>Setting Hi</b> .....	35 minutes

- Do not put liquid or water in the warming drawer.
- For moist foods, cover them with a lid or aluminum foil.
- For crisp foods, leave them uncovered.
- Food should be kept hot in its cooking container or transferred to a heat-safe serving dish.

**⚠ CAUTION:** *Plastic containers or plastic wrap will melt if in direct contact with the drawer or a hot utensil. Melted plastic may not be removable and is not covered under your warranty.*

- Remove serving spoons, etc., before placing containers in warming drawer.

### Temperature Selection Chart

To keep several different foods hot, set the control to the food needing the highest setting.

- The temperature, type and amount of food, and the time held will affect the quality of the food.
- Food in heat-safe glass and glass-ceramic utensils may need a higher control setting as compared to food in metal utensils.
- Repeated opening of the drawer allows hot air to escape and food to cool.
- Allow extra time for the temperature inside the drawer to stabilize after adding items.
- With large loads it may be necessary to use a higher thermostat setting and cover some of the cooked food items.
- Do not use plastic containers or plastic wrap.

Food Type	Control Setting
Bacon	Hi
Breads	Medium
Casserole	Medium
Chicken, fried	Hi
Eggs, scrambled	Medium
Fish	Hi
Gravy, sauces	Hi
Ham	Hi
Muffins	Medium
Onion rings	Hi
Pies	Lo
Pizza	Hi
Potatoes, baked	Hi
Potatoes, mashed	Lo
Tortilla Chips	Lo

**⚠ CAUTION:** Do not keep food in the warming drawer for more than two hours.

### To Crisp Stale Items

- Place food in low-sided dishes or pans.
- Preheat on **Lo** setting.
- Check crispness after 45 minutes. Add time as needed.

### To Warm Serving Bowls and Plates

To warm serving bowls and plates, set the control on **Lo**.

- Use only heat-safe dishes.
- If you want to heat fine china, please check with the manufacturer of the dishes for their maximum heat tolerance.

- You may warm empty serving dishes while preheating the drawer.

**⚠ CAUTION:** Dishes will be hot. Use pot holders or mitts when removing hot dishes.

## Using the self-cleaning oven.

Never force the latch handle. Forcing the handle will damage the door lock mechanism.

The oven door must be closed and all controls set correctly for the cycle to work properly.

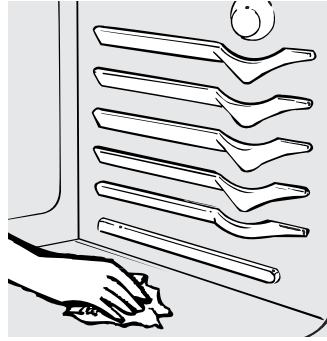

Wipe up heavy soil on the oven bottom.

### Before a Clean Cycle

For the first self-clean cycle, we recommend venting your kitchen with an open window or using a ventilation fan or hood.

Remove the racks, any broiler pan, broiler grid, all cookware and any aluminum foil from the oven.

The oven racks can be self-cleaned, but they will darken, lose their luster and become hard to slide.

Do not use commercial oven cleaners or oven protectors in or near the self-cleaning oven. A combination of any of these products plus the high clean cycle temperatures may damage the porcelain finish of the oven.

Soil on the front frame of the range and outside the gasket on the door will need to be cleaned by hand. Clean these areas with hot water, soap-filled scouring pads or cleansers such as Soft Scrub®. Rinse well with clean water and dry.

Do not clean the gasket. The fiberglass material of the oven door gasket cannot withstand abrasion. It is essential for the gasket to remain intact. If you notice it becoming worn or frayed, replace it.

Wipe up any heavy spillovers on the oven bottom.

Make sure the oven light bulb cover is in place and the oven light is off.

**CAUTION:** The *grates and drip pans (if so equipped) should never be cleaned in the self-cleaning oven.*

**Do not use commercial oven cleaners or oven protectors in or near the self-cleaning oven.** A combination of any of these products plus the high clean cycle temperatures may damage the porcelain finish of the oven.

**IMPORTANT:** The health of some birds is extremely sensitive to the fumes given off during the self-cleaning cycle of any range. Move birds to another well-ventilated room.

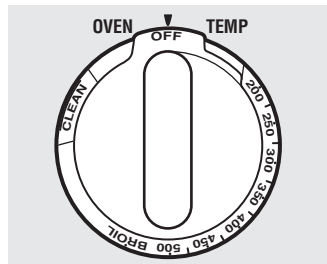

### How to Set the Oven for Cleaning (on models with an OVEN TEMP Knob)

Follow the directions in the *Before a Clean Cycle* section.

- 1 Latch the door.
- 2 Turn the **OVEN TEMP** knob to **CLEAN**.

*The Clean Time is 4 hours and 20 minutes. The self-clean light will come on and stay on until the self-clean cycle is complete.*

*The oven shuts off automatically when the clean cycle is complete.*

- 3 After a clean cycle, turn the **OVEN TEMP** knob to **OFF** and slide the latch handle to the left as far as it will go.

To cancel self-clean cycle, turn **OVEN TEMP** knob to off and slide latch to left as far as it will go. Wait until self-clean light stops blinking. Use oven as desired.

**NOTE:** Never force the latch. If the oven is too hot, you will not be able to slide the latch. Allow the oven to cool.

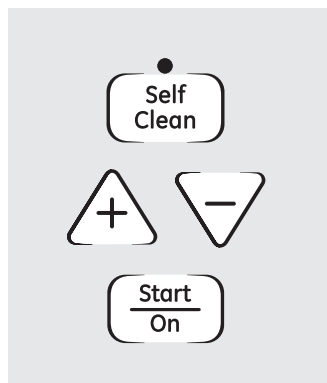

### How to Set the Oven for Cleaning

Follow the directions in the *Before a Clean Cycle* section.

- 1 Latch the door.
- NOTE:** Never force the latch. If the oven is too hot, you will not be able to slide the latch. Allow the oven to cool.
- 2 Touch the **Self Clean** pad.
- 3 Touch the **+** or **-** pads until the desired Clean Time is displayed.

*The Clean Time is normally 4 hours and 20 minutes. You can change the Clean Time to any time between 3 and 5 hours, depending on the amount of soil in your oven.*

- 4 Touch the **Start/On** pad.

The self-clean cycle will automatically begin after **CLEAN** is displayed and the time countdown appears in the display.

While the oven is self-cleaning, you can touch the **Clock** pad to display the time of day. To return to the clean countdown, touch the **Self Clean** pad.

The oven shuts off automatically when the clean cycle is complete, and 0:00 will flash in the display.

- 5 Slide the latch handle to the left as far as it will go and open the door.

The oven door must be closed and all controls set correctly for the cycle to work properly.

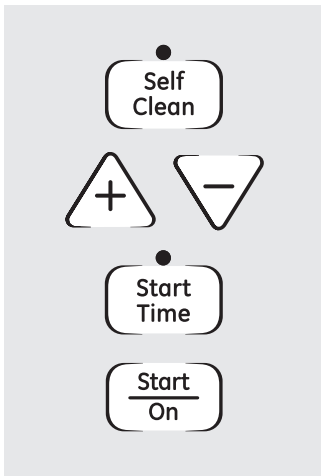

### How to Delay the Start of Cleaning (on some models)

You can set the oven control to delay-start the oven, clean for a specific length of time and then turn off automatically.

Make sure the clock shows the correct time of day.

Follow the directions in the *Before a Clean Cycle* section.

**1** Latch the door.

**NOTE:** Never force the latch. If the oven is too hot, you will not be able to slide the latch. Allow the oven to cool.

**2** Touch the **Self Clean** pad.

**3** Touch the **+** or **-** pads to set the Clean Time.

The Clean Time is preset for 4 hours and 20 minutes. You can change the Clean Time to any time between 3 and 5 hours, depending on the amount of soil in your oven. If a different Clean Time is desired, touch the **+** or **-** pads until the desired Clean Time is displayed.

**4** Touch the **Start Time** pad.

Change the Start Time by touching the **+** or **-** pads. The start time will appear in the display.

**5** Touch the **Start/On** pad.

The self-clean cycle will automatically begin at the time set.

While the oven is self-cleaning, you can touch the **Clock** pad to display the time of day. To return to the clean countdown, touch the **Self Clean** pad.

The oven shuts off automatically when the clean cycle is complete, and 0:00 will flash in the display.

**6** Slide the latch handle to the left as far as it will go and open the door.

### To Stop a Clean Cycle (on some models)

Touch the **Clear/Off** pad.

Wait until the oven has cooled below the locking temperature to unlatch the door. You will not be able to open the door right away unless the oven has cooled below the locking temperature.

### After a Clean Cycle (on some models)

You cannot set the oven for cooking until the oven is cool enough for the door to be unlatched.

You may notice some white ash in the oven. Wipe it up with a damp cloth after the oven cools.

If white spots remain, remove them with a soap-filled scouring pad and rinse thoroughly with a vinegar and water mixture.

These deposits are usually a salt residue that cannot be removed by the clean cycle.

If the oven is not clean after one clean cycle, repeat the cycle.

■ You cannot set the oven for cooking until the oven is cool enough for the door to unlock.

■ While the oven is self-cleaning, you can touch the **Clock** pad to display the time of day. To return to the clean countdown, touch the **Cooking Time** pad.

■ If the racks become hard to slide, apply a small amount of vegetable oil or cooking oil to a paper towel and wipe the edges of the oven racks with the paper towel.

## Care and cleaning of the range.

Be sure electrical power is off and all surfaces are cool before cleaning any part of the range.

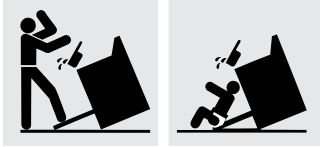

**⚠ WARNING:** If your range is removed for cleaning, servicing or any reason, be sure the anti-tip device is reengaged properly when the range is replaced. Failure to take this precaution could result in tipping of the range and cause injury.

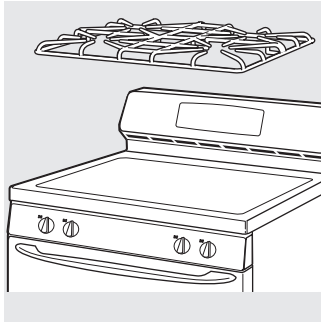

### Burner Grates

Lift out when cool. Grates should be washed regularly and, of course, after spillovers. Wash them in hot, soapy water and rinse with clean water. When replacing the grates, be sure they are positioned securely over the burners.

On models with professional-style double grates, the grates are position-specific. For maximum stability, these grates should only be used in their proper position; they cannot be interchanged left to right or front to back. For convenience, the undersides of the left and right grates are marked "LEFT FRONT" and "RIGHT FRONT."

Do not operate a burner for an extended period of time without cookware on the grate. The finish on the grate may chip without cookware to absorb the heat.

To get rid of burned-on food, place the grates in a covered container. Add 1/4 cup ammonia and let them soak several hours or overnight. Wash, rinse well and dry.

Although they are durable, the grates will gradually lose their shine, regardless of the best care you can give them. This is due to their continual exposure to high temperatures. You will notice this sooner with lighter color grates.

**NOTE:** Do not clean the grates in a self-cleaning oven.

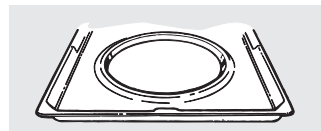

### Drip Pans (if so equipped)

Remove the grates and lift out the drip pans. Drip pans can be cleaned in a dishwasher or by hand.

When replacing the drip pans, make sure they are in the correct position.

Place them in a covered container. Add 1/4 cup ammonia and let soak several hours or overnight. Wash, rinse well and dry.

**⚠ CAUTION:** Do not clean the drip pans in a self-cleaning oven.



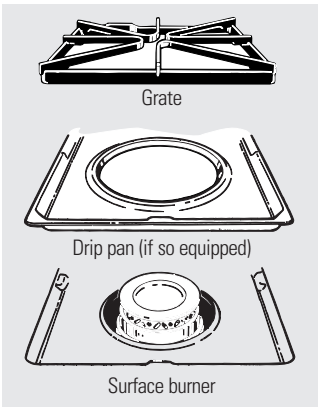

**Standard Twin Burner Assemblies** (on some models)

For cleaning information on sealed burners, see section below. Sealed burner cooktops do not lift up.

On models with standard twin burners, the cooktop lifts up for easy access.

Turn all controls **OFF** before removing burner parts and drip pans (if so equipped).

The burner grates and drip pans (if so equipped) can be lifted off, making them easy to clean.

The holes in the surface burners of your range must be kept clean at all times for proper ignition and an even, unhampered flame.

You should clean the surface burners routinely, especially after bad spillovers, which could clog these holes.

Wipe off surface burners. If heavy spillover occurs, remove the surface burners from the range. Burners lift out for cleaning. Lift up the cooktop and then lift out the surface burners.

To remove burned-on food, soak the surface burner in a solution of mild liquid detergent and hot water. Soak the surface burner for 20 to 30 minutes.

For more stubborn stains, use a cleanser like Soft Scrub® brand or Bon Ami® brand. Rinse well to remove any traces of the cleanser that might clog the surface burner openings.

Do not use steel wool because it will clog the surface burner openings and scratch the surface burners. If the holes become clogged, clean them with a sewing needle or twist-tie.

Before putting the surface burner back, shake out excess water and then dry it thoroughly by setting it in a warm oven for 30 minutes. Then place it back in the range, making sure it is properly seated and level.

Check the flame pattern of each burner. If the flames are “jumpy” (not steady), clean the holes again with a sewing needle or twist-tie.

**CAUTION:** Do not operate the cooktop without all burner parts, drip pans (if so equipped) and grates in place.

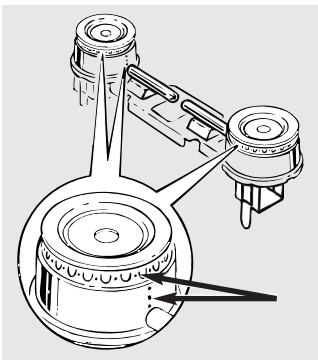

Clean these holes thoroughly on each burner.

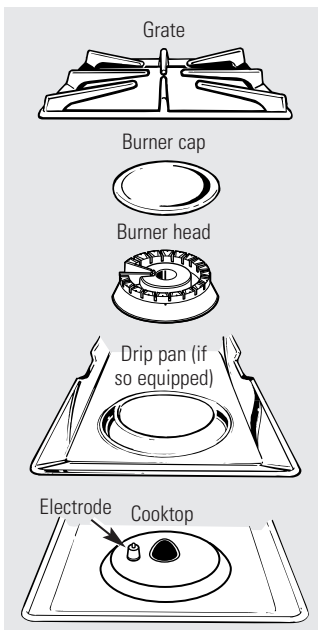

**Sealed Burner Assemblies** (on some models)

Turn all controls **OFF** before removing the burner parts and drip pans (if so equipped).

The burner grates, caps, burner heads and drip pans (if so equipped) can be lifted off, making them easy to clean.

**CAUTION:** Do not operate the cooktop without all burner parts, drip pans (if so equipped) and grates in place.

**NOTE:** Do not lift the cooktop. Lifting the cooktop on sealed burner models can lead to damage and improper operation of the range.

The electrode of the spark igniter is exposed when the burner head is removed. When one burner is turned to **LITE**, all the burners spark. Do not attempt to disassemble or clean around any burner while another burner is on. An electric shock may result, which could cause you to knock over hot cookware.

# Care and cleaning of the range.

## Burner Caps and Heads

**NOTE:** Before removing the burner caps and heads, remember their size and location. Replace them in the same location after cleaning.

### Burner caps

Lift off when cool. Wash burner caps in hot, soapy water and rinse with clean water. You may scour with a plastic scouring pad to remove burned-on food particles.

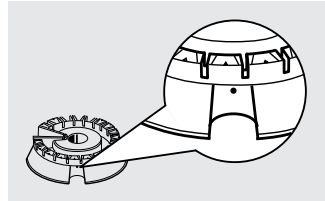

Use a sewing needle or twist-tie to unclog the small hole in the burner head.

### Burner heads

For proper ignition, make sure the small hole in the section that fits over the electrode is kept open. A sewing needle or wire twist-tie works well to unclog it.

*The slits in the burner heads must be kept clean at all times for an even, unhampered flame.*

Clogged or dirty burner ports or electrodes will not allow the burner to operate properly.

Any spill on or around an electrode must be carefully cleaned. Take care to not hit an electrode with anything hard or it could be damaged.

You should clean the burner caps and burner heads routinely, especially after bad spillovers, which could clog the openings in the burner heads. Lift off when cool.

To remove burned-on food, soak the burner heads in a solution of mild liquid detergent and hot water for 20–30 minutes. For more stubborn stains, use a toothbrush.

### After cleaning

Before putting the burner caps and heads back, shake out excess water and then dry them thoroughly by setting in a warm oven for 30 minutes.

**NOTE:** Do not use steel wool or scouring powders to clean the burners.

### Replacement

Replace burner heads over the electrodes on the cooktop, in the correct locations according to their size.

#### On some models:

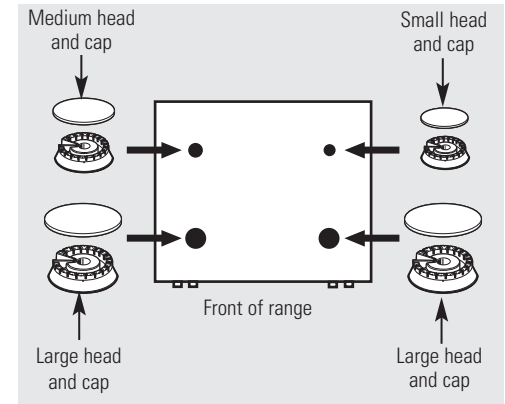

#### On some models:

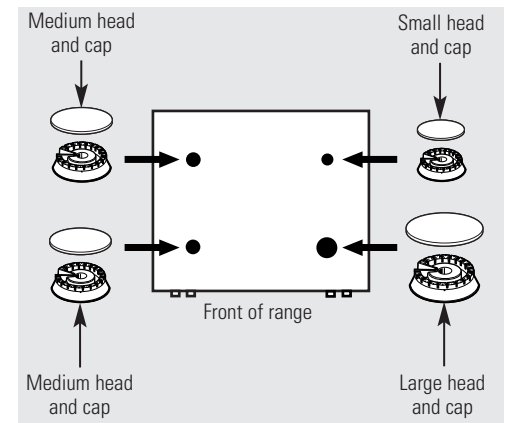

Make sure the slot in the burner head is positioned over the electrode.

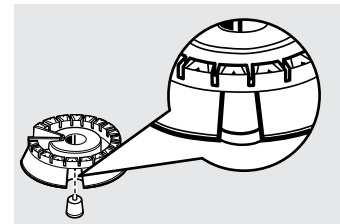

Replace the matching size caps onto the heads.

Make sure that the heads and caps are replaced in the correct locations.

**NOTE:** On some models, the burners are all the same size and power.

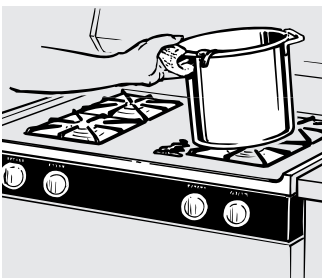

### Cooktop Surface

To avoid damaging the porcelain-enamel surface of the cooktop and to prevent it from becoming dull, clean up spills right away. Foods with a lot of acid (tomatoes, sauerkraut, fruit juices, etc.) or foods with high sugar content could cause a dull spot if allowed to set.

When the surface has cooled, wash and rinse. For other spills such as fat splatterings, wash with soap and water once the surface has cooled. Then rinse and polish with a dry cloth.

**NOTE:** Do not store flammable materials in an oven or near the cooktop. Do not store or use combustible materials, gasoline or other flammable vapors and liquids in the vicinity of this or any other appliance.

**NOTE:** Do not lift the cooktop on sealed burner models. Lifting the cooktop can lead to damage and improper operation of the range.

### Stainless Steel Surfaces (on some models)

**Do not use a steel wool pad; it will scratch the surface.**

To clean the stainless steel surface, use warm sudsy water or a stainless steel cleaner or polish. Always wipe the surface in the direction of the grain. Follow the cleaner instructions for cleaning the stainless steel surface.

To inquire about purchasing stainless steel appliance cleaner or polish, or to find the location of a dealer nearest you, please call our toll-free number:

**National Parts Center 800.626.2002 (U.S.)**  
**800.661.1616 (Canada)**  
**GEAppliances.com (U.S.)**  
**www.GEAppliances.ca (Canada)**

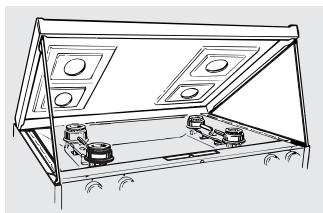

Some models have dual support rods that will hold the cooktop up while you clean underneath it.

### Lift-Up Cooktop (on models with standard twin burners)

Clean the area under the cooktop often. Built-up soil, especially grease, may catch on fire.

To make cleaning easier, the cooktop may be lifted up.

**NOTE:** Do not lift the cooktop on sealed burner models. Lifting the cooktop can lead to damage and improper operation of the range.

#### To raise the cooktop:

- 1 Be sure the burners are turned off.
- 2 Remove the grates.
- 3 Grasp the two front burner wells and lift up.

Clean under the cooktop with hot, soapy water and a clean cloth. If you removed your surface burners while cleaning, make sure they are properly seated when replacing them.

After cleaning, lower the cooktop (be careful not to pinch your fingers).

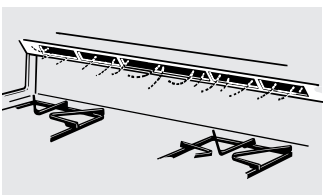

Vent appearance and location vary.

### Oven Air Vents

Never block the vents (air openings) of the range. They provide the air inlet and outlet that are necessary for the range to operate properly with correct combustion.

Air openings are located at the rear of the cooktop, at the top and bottom of the oven door, and at the bottom of the range, under the warming drawer, storage drawer or kick panel (depending on the model).

## Care and cleaning of the range.

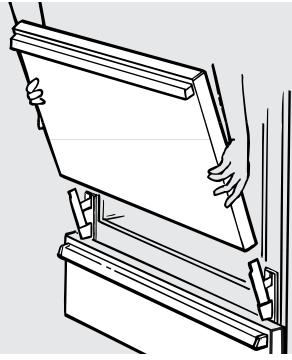

Lift the door straight up and off the hinges.

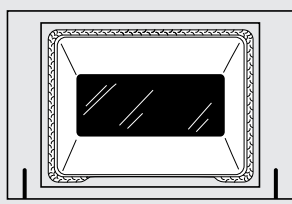

The gasket is designed with a gap at the bottom to allow for proper air circulation.

Do not rub or clean the door gasket—it has an extremely low resistance to abrasion.

If you notice the gasket becoming worn, frayed or damaged in any way or if it has become displaced on the door, you should have it replaced.

### Lift-Off Oven Door

The oven door is removable, but it is heavy. You may need help removing and replacing the door.

**To remove the door**, open it a few inches to the special stop position that will hold the door open. Grasp firmly on each side and lift the door straight up and off the hinges.

**NOTE:** Be careful not to place hands between the hinge and the oven door frame since the hinge could snap back and pinch fingers.

**To replace the door**, make sure the hinges are in the special stop position. Position the slots in the bottom of the door squarely over the hinges. Then lower the door slowly and evenly over both hinges at the same time. If the hinges snap back against the oven frame, pull them back out.

### To clean the inside of the door:

- Do not allow excess water to run into any holes or slots in the door.
- Because the area inside the gasket is cleaned during the self-clean cycle, you do not need to clean this by hand. Any soap left on the liner causes additional stains when the oven is heated.

- The area outside the gasket can be cleaned with a soap-filled scouring pad.

### To clean the outside of the door:

- Use soap and water to thoroughly clean the top, sides and front of the oven door. Rinse well. You may also use a glass cleaner to clean the glass on the outside of the door.
- Spillage of marinades, fruit juices, tomato sauces and basting materials containing acids may cause discoloration and should be wiped up immediately. When the surface is cool, clean and rinse.
- Do not use oven cleaners, cleansing powders or harsh abrasives on the outside of the door.

### Oven Bottom

The oven bottom has a porcelain-enamel finish. To make cleaning easier, protect the oven bottom from excessive spillovers by placing a cookie sheet on the rack below the rack you are cooking on. This is particularly important when baking a fruit pie or other foods with a high acid content. Hot fruit fillings or other foods that are highly acidic (such as tomatoes, sauerkraut, and sauces with vinegar or lemon juice) may cause pitting and damage to the porcelain-enamel surface and should be wiped up immediately.

We don't recommend using aluminum foil on the oven bottom. It can affect airflow if the holes are blocked and it can concentrate heat at the bottom of the oven, resulting in poor baking performance.

To clean up spillovers, use soap and water, an abrasive cleaner or soap-filled scouring pad. Rinse well to remove any soap before self-cleaning.

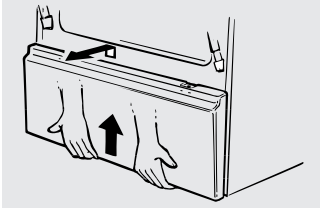

**Removable Kick Panel** (on some models)

The kick panel may be removed for cleaning under the range.

**To remove:**

Lift up the bottom of the panel slightly to disengage the panel from the tabs at the base of the range. Pull the bottom of the panel forward until the spring clips are released at the top of the panel.

**To replace:**

Insert the two slots at the bottom of the panel onto the two tabs at the base of the range, and push the top of the panel forward to engage the spring clips.

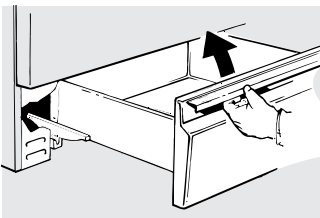
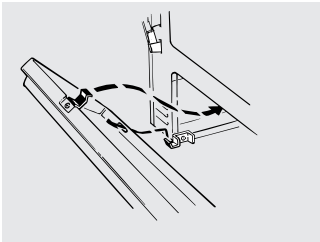

The storage drawer may be removed for cleaning under the range.

**Removable Storage Drawer** (on some models)

The storage drawer is a good place to store cookware and bakeware. Do not store plastics and flammable material in the drawer.

The storage drawer may be removed for cleaning under the range. Clean the storage drawer with a damp cloth or sponge. Never use harsh abrasives or scouring pads.

**To remove storage drawer:**

- 1 Pull drawer straight out until it stops.
- 2 Tilt the front of the drawer up and free of the range.

**To replace storage drawer:**

- 1 Set the stops on the back of the drawer over the stops in the range.
- 2 Slide drawer evenly and straight back, so that the rails in the range are engaged.

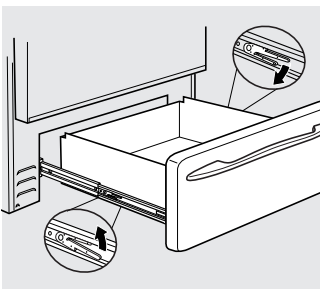

**Removable Warming Drawer** (on some models)

**NOTE:** For models with an electric warming drawer, before performing any adjustments, cleaning or service, disconnect the range electrical power supply at the household distribution panel by removing the fuse or switching off the circuit breaker. Make sure the warming drawer heating element is cool.

Most cleaning can be done with the drawer in place. However, the drawer may be removed if further cleaning is needed. Use soap and warm water to thoroughly clean.

**To remove the warming drawer:**

- 1 Pull the drawer straight out until it stops.
- 2 Press the left rail release up and press the right rail release down, while pulling the drawer forward and free.

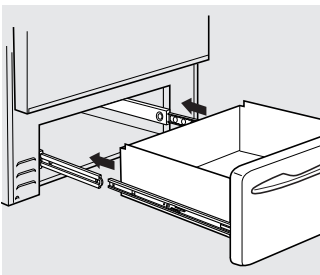

**To replace the warming drawer:**

- 1 Place the left drawer rail around the inner left rail guide and slide it in slightly to hook it.
- 2 Place the right drawer rail around the inner right rail guide and slide it in slightly to hook it.
- 3 Slide the drawer all the way in.



## Care and cleaning of the range.

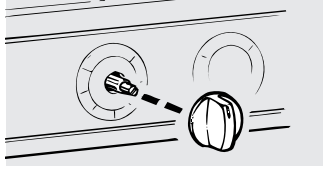

Pull the knob straight off the stem.

### Lower Control Panel (Front Manifold Panel) and Knobs

It's a good idea to wipe the control panel after each use of the oven. Use a damp cloth to clean or rinse. For cleaning, use mild soap and water or a 50/50 solution of vinegar and water. For rinsing, use clean water. Polish dry with a soft cloth.

Do not use abrasive cleansers, strong liquid cleaners, plastic scouring pads or oven cleaners on the control panel—they will damage the finish.

Do not bend knobs by pulling them up or down or by hanging a towel or other such loads. This can damage the gas valve shaft.

The control knobs may be removed for easier cleaning.

Make sure the knobs are in the **Off** positions and pull them straight off the stems for cleaning.

The knobs can be cleaned in a dishwasher or they may also be washed with soap and water. Make sure the insides of the knobs are dry before replacing.

Replace the knobs in the **Off** position to ensure proper placement.

Metal parts can be cleaned with soap and water. Do not use steel wool, abrasives, ammonia, acids or commercial oven cleaners. Dry with a soft cloth.

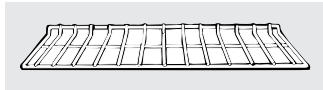

### Oven Racks

Clean the racks with an abrasive cleanser or scouring pad. After cleaning, rinse the racks with clean water and dry with a clean cloth.

If the racks ever become hard to slide, wipe the rack edges or oven rack supports with vegetable oil.

**NOTE:** Take the racks out of the oven before you begin the self-clean cycle or they may discolor.

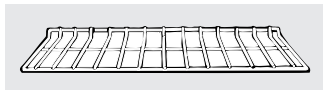

### Heavy-Duty Oven Racks (on some models)

Clean the racks with an abrasive cleanser.

The oven racks may be cleaned in the self-cleaning oven. However, the racks will darken in color, lose their luster and become hard to slide if cleaned during the self-cleaning cycle.

To make the racks slide more easily, apply a small amount of vegetable oil or cooking oil to a paper towel and wipe the edges of the oven racks with the paper towel.

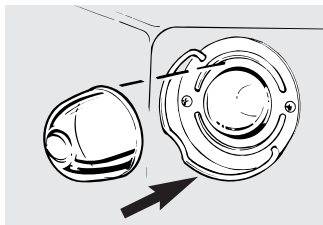

Wire cover holder.

### Oven Light Replacement

**CAUTION:** Before replacing your oven light bulb, disconnect the electrical power to the range at the main fuse or circuit breaker panel. Be sure to let the light cover and bulb cool completely.

The oven light bulb is covered with a removable glass cover that is held in place with a bail-shaped wire. Remove the oven door, if desired, to reach cover easily.

#### To remove:

- 1 Hold a hand under the cover so it doesn't fall when released. With fingers of the same hand, firmly push back the wire cover holder. Lift off the cover.

**Do not remove any screws to remove the cover.**

- 2 Do not touch hot bulb with a wet cloth. Replace bulb with a 40-watt household appliance bulb.

#### To replace cover:

- 1 Place it into the groove of the light receptacle. Pull the wire forward to the center of the cover until it snaps into place. When in place, the wire holds the cover firmly. Be certain the wire is in the depression in the center of the cover.

- 2 Connect electrical power to the range.



If you have questions, call 1.800.GE.CARES or visit our Website at: [GEAppliances.com](http://GEAppliances.com)

## In the Commonwealth of Massachusetts:

- This product must be installed by a licensed plumber or gas fitter.
- When using ball-type gas shut-off valves, they shall be the T-handle type.
- A flexible gas connector, when used, must not exceed 3 feet.

## BEFORE YOU BEGIN

Read these instructions completely and carefully.

Installation of this range must conform with local codes or, in the absence of local codes, with the National Fuel Gas Code, ANSI Z223.1/NFPA.54, latest edition. In Canada, installation must conform with the current Natural Gas Installation Code, CAN/CGA-B149.1 or the current Propane Installation Code, CAN/CGA-B149.2, and with local codes where applicable. This range has been design-certified by CSA International according to ANSI Z21.1, latest edition, and Canadian Gas Association according to CAN/CGA-1.1 latest edition.

As with any appliance using gas and generating heat, there are certain safety precautions you should follow. You will find these precautions in the *Important Safety Information* section in the front of this manual. Read them carefully.

- **IMPORTANT** – Save these instructions for local electrical inspector's use.
- **IMPORTANT** – Observe all governing codes and ordinances.
- **Note to Installer** – Be sure to leave these instructions with the Consumer.
- **Note to Consumer** – Keep these instructions for future reference.
- **Note** – This appliance must be properly grounded.
- **Service** – The electrical diagram is in an envelope attached to the back of the range.
- **Skill level** – Installation of this appliance requires basic mechanical skills.
- Proper installation is the responsibility of the installer.
- Product failure due to improper installation is not covered under the Warranty.

## PART INCLUDED

Anti-Tip bracket kit

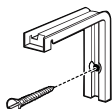

## FOR YOUR SAFETY

Do not store or use combustible materials, gasoline or other flammable vapors and liquids in the vicinity of this or any other appliance.

If you smell gas:

- 1 Open windows.
- 2 Don't touch electrical switches.
- 3 Extinguish any open flame.
- 4 Immediately call your gas supplier.

## TOOLS YOU WILL NEED

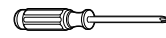

Phillips screwdriver

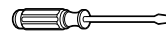

Flat-blade screwdriver



Pencil and ruler

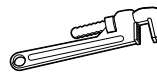

Pipe wrenches (2)  
(one for backup)



Open-end or  
adjustable wrench



Level



Drill, awl or nail

## MATERIALS YOU MAY NEED

- Gas line shut-off valve.
- Pipe-joint sealant or UL-approved pipe thread tape with Teflon\* that resists action of natural and LP gases.
- Flexible metal appliance connector (1/2" I.D.)  
A 5-foot length is recommended for ease of installation but other lengths are acceptable. Never use an old connector when installing a new range.
- Flare union adapter for connection to gas supply line (3/4" or 1/2" NPT x 1/2" I.D.)
- Flare union adapter for connection to pressure regulator on range (1/2" NPT x 1/2" I.D.)
- Liquid leak detector or soapy water.
- Lag bolt or 1/2" O.D. sleeve anchor (for concrete floors only).

\*Teflon: Registered trademark of DuPont

# Installation Instructions

## **⚠ WARNING!** **INSTALLATION SAFETY INSTRUCTIONS**

Read these instructions completely and carefully.

**Improper installation, adjustment, alteration, service or maintenance can cause injury or property damage. Refer to this manual. For assistance or additional information, consult a qualified installer, service agency, manufacturer (dealer) or the gas supplier.**

Never reuse old flexible connectors. The use of old flexible connectors can cause gas leaks and personal injury. Always use **NEW** flexible connectors when installing a gas appliance.

**IMPORTANT** – Remove all packing material and literature from oven before connecting gas and electrical supply to range.

**⚠ CAUTION** – Do not attempt to operate the oven of this range during a power failure (Electric Ignition models only).

- Have your range installed by a qualified installer.
- Your range must be electrically grounded in accordance with local codes or, in the absence of local codes, in accordance with the National Electrical Code (ANSI/NFPA 70, latest edition). In Canada, electrical grounding must be in accordance with the current CSA C22.1 Canadian Electrical Code Part 1 and/or local codes. See *Electrical Connections* in this section.
- Before installing your range on linoleum or any other synthetic floor covering, make sure the floor covering can withstand 180°F without shrinking, warping or discoloring. Do not install the range over carpeting unless a sheet of 1/4" thick plywood or similar insulator is placed between the range and carpeting.
- Make sure the wall coverings around the range can withstand heat generated by the range up to 200°F.

- Avoid placing cabinets above the range. To reduce the hazard caused by reaching over the open flames of operating burners, install a ventilation hood over the range that projects forward at least 5" beyond the front of the cabinets.

- The ventilating hood must be constructed of sheet metal not less than 0.0122" thick. Install above the cooktop with a clearance of not less than 1/4" between the hood and the underside of the combustible material or metal cabinet. The hood must be at least as wide as the appliance and centered over the appliance. Clearance between the cooking surface and the ventilation hood surface **MUST NEVER BE LESS THAN 24 INCHES.**

**EXCEPTION:** Installation of a listed microwave oven or cooking appliance over the cooktop shall conform to the installation instructions packed with that appliance.

- If cabinets are placed above the range, allow a minimum clearance of 30" between the cooking surface and the bottom of unprotected cabinets.

- If a 30" clearance between cooking surface and overhead combustible material or metal cabinets cannot be maintained, protect the underside of the cabinets above the cooktop with not less than 1/4" insulating millboard covered with sheet metal not less than 0.0122" thick. Clearance between the cooking surface and protected cabinets **MUST NEVER BE LESS THAN 24 INCHES.**

- The vertical distance from the plane of the cooking surface to the bottom of adjacent overhead cabinets extending closer than 1" to the plane of the range sides must not be less than 18". (See the *Dimensions and Clearances* illustration in this section.)

- **⚠ CAUTION** – Items of interest to children should not be stored in cabinets above a range or on the backsplash of a range—children climbing on the range to reach items could be seriously injured.

# Installation Instructions

## DIMENSIONS AND CLEARANCES

Provide adequate clearances between the range and adjacent combustible surfaces. These dimensions must be met for safe use of your range. The location of the electrical outlet and pipe opening (see Gas Pipe and Electric Outlet Locations) may be adjusted to meet specific requirements.

The range may be placed with 0" clearance (flush) at the back wall.

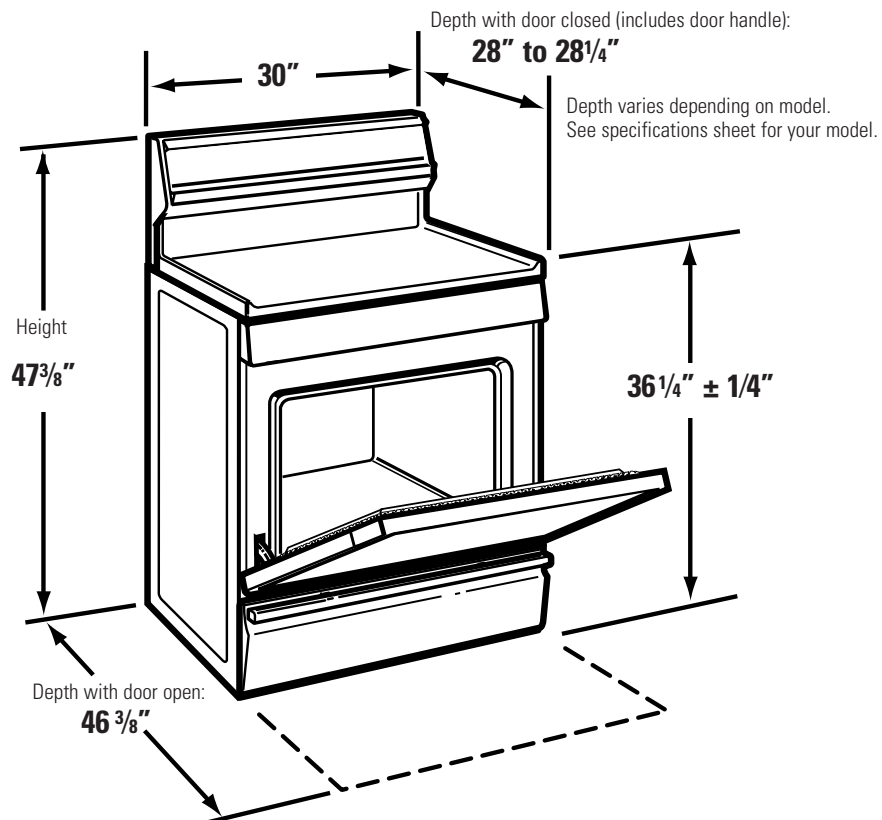
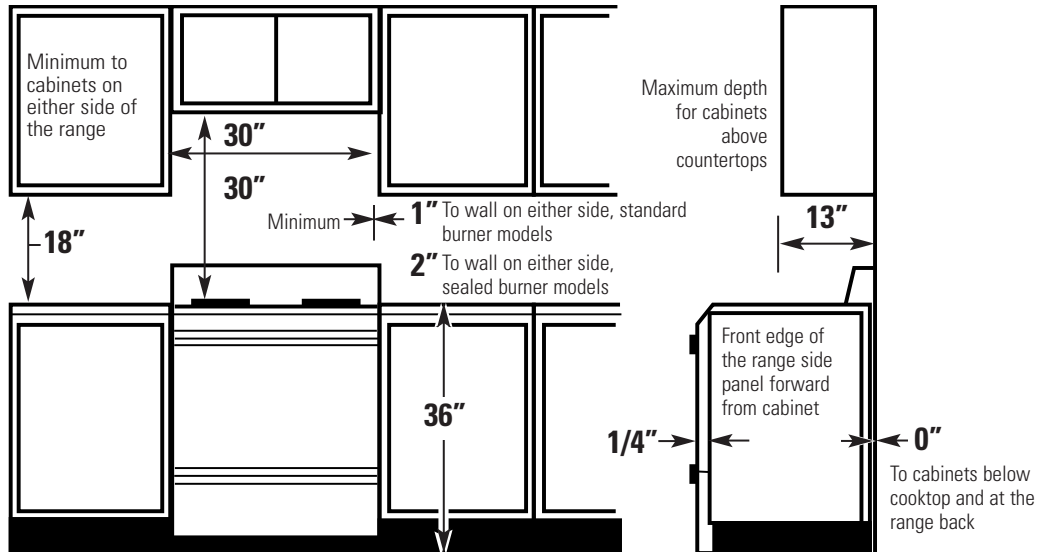

# Installation Instructions

## **⚠ WARNING!** **ANTI-TIP DEVICE**

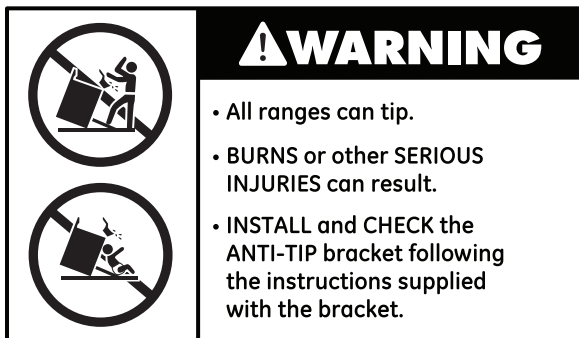

To reduce the risk of tipping the range, the range must be secured by a properly installed anti-tip bracket. See installation instructions shipped with the bracket for complete details before attempting to install.

To check if the bracket is installed and engaged properly, carefully tip the range forward. The bracket should stop the range within 4 inches. If it does not, the bracket must be reinstalled. If the range is pulled from the wall for any reason, always repeat this procedure to verify the range is properly secured by the anti-tip bracket.

For free-standing or slide-in ranges, never completely remove the leveling legs or the range will not be secured to the anti-tip device properly.

If you did not receive an anti-tip bracket with your purchase, call 1.800.626.8774 to receive one at no cost (in Canada, call 1.800.561.3344). For installation instructions of the bracket, visit [GEAppliances.com](http://GEAppliances.com) (in Canada, [GEAppliances.ca](http://GEAppliances.ca)).

- For your safety, never use your range for warming or heating the room. Your oven and cooktop are not designed to heat your kitchen. Top burners should not be operated without cookware on the grate. Such abuse could result in fire and damage to your range and will void your warranty.
- Do not store or use combustible materials, gasoline or other flammable vapors and liquids in the vicinity of this or any other appliance. Explosions or fires could result.
- Do not use oven for a storage area. Items stored in the oven can ignite.
- Do not let cooking grease or other flammable materials accumulate in or near the range.

## **LOCATION**

Do not locate the range where it may be subject to strong drafts. Any openings in the floor or wall behind the range should be sealed. Make sure the openings around the base of the range that supply fresh air for combustion and ventilation are not obstructed by carpeting or woodwork.

Your range, like many other household items, is heavy and can settle into soft floor coverings such as cushioned vinyl or carpeting. Use care when moving the range on this type of flooring. It is recommended that the following simple and inexpensive instructions be followed to protect your floor.

The range should be installed on a sheet of plywood (or similar material). When the floor covering ends at the front of the range, the area that the range will rest on should be built up with plywood to the same level or higher than the floor covering.

This will allow the range to be moved for cleaning or servicing. Also, make sure your floor covering will withstand 180°F. (See the *Installation Safety Instructions* section.)

Make sure the wall coverings around your range can withstand the heat generated (up to 200°F) by the range. (See the *Installation Safety Instructions* section.)

## **IMPORTANT!**

**Remove all tape and packaging. Make sure the burners are properly seated and level.**

**Lift up the cooktop (on models with standard twin burners) and remove any packing material under it.**

**Take the accessory pack out of the oven and/or drawer.**

**Check to be sure that no range parts have come loose during shipping.**

# Installation Instructions

## 1 PROVIDE ADEQUATE GAS SUPPLY

Your range is designed to operate at a pressure of 4" of water column on natural gas or, if designed for LP gas (propane or butane), 10" of water column.

Make sure you are supplying your range with the type of gas for which it is designed.

This range is convertible for use on natural or propane gas. If you decide to use this range on LP gas, conversion must be made by a qualified LP installer before attempting to operate the range on that gas.

For proper operation, the pressure of natural gas supplied to the regulator must be between 4" and 13" of water column.

For LP gas, the pressure supplied must be between 10" and 13" of water column.

When checking for proper operation of the regulator, the inlet pressure must be at least 1" greater than the operating (manifold) pressure as given above.

The pressure regulator located at the inlet of the range manifold must remain in the supply line regardless of whether natural or LP gas is being used.

A flexible metal appliance connector used to connect the range to the gas supply line should have an I.D. of 1/2" and be 5 feet in length for ease of installation. In Canada, flexible connectors must be single wall metal connectors no longer than 6 feet in length.

## 2 CONNECT THE RANGE TO GAS

Shut off the main gas supply valve before disconnecting the old range and leave it off until the new hookup has been completed. Don't forget to relight the pilot on other gas appliances when you turn the gas back on.

Because hard piping restricts movement of the range, the use of a CSA International-certified flexible metal appliance connector is recommended unless local codes require a hard-piped connection.

Never use an old connector when installing a new range. If the hard piping method is used, you must carefully align the pipe; the range cannot be moved after the connection is made.

To prevent gas leaks, put pipe-joint compound on, or wrap pipe-thread tape with Teflon\* around, all male (external) pipe threads.

- A. Install a manual gas line shut-off valve in the gas line in an easily accessed location outside of the range. Make sure everyone operating the range knows where and how to shut off the gas supply to the range.
- B. Install male 1/2" flare union adapter to the 1/2" NPT internal thread at inlet of regulator. Use a backup wrench on the regulator fitting to avoid damage.  
  
When installing the range from the front, remove the 90° elbow for easier installation.
- C. Install male 1/2" or 3/4" flare union adapter to the NPT internal thread of the manual shut-off valve, taking care to back up the shut-off valve to keep it from turning.
- D. Connect flexible metal appliance connector to the adapter on the range. Position range to permit connection at the shut-off valve.
- E. When all connections have been made, make sure all range controls are in the off position and turn on the main gas supply valve. Use a liquid leak detector at all joints and connections to check for leaks in the system.

**⚠ WARNING: DO NOT USE A FLAME TO CHECK FOR GAS LEAKS.**

When using test pressures greater than 1/2 psig to pressure test the gas supply system of the residence, disconnect the range and individual shut-off valve from the gas supply piping. When using test pressures of 1/2 psig or less to test the gas supply system, simply isolate the range from the gas supply system by closing the individual shut-off valve.

\*Teflon: Registered trademark of DuPont

# Installation Instructions

## GAS PIPE AND ELECTRICAL OUTLET LOCATIONS (for models with Sealed Burners)

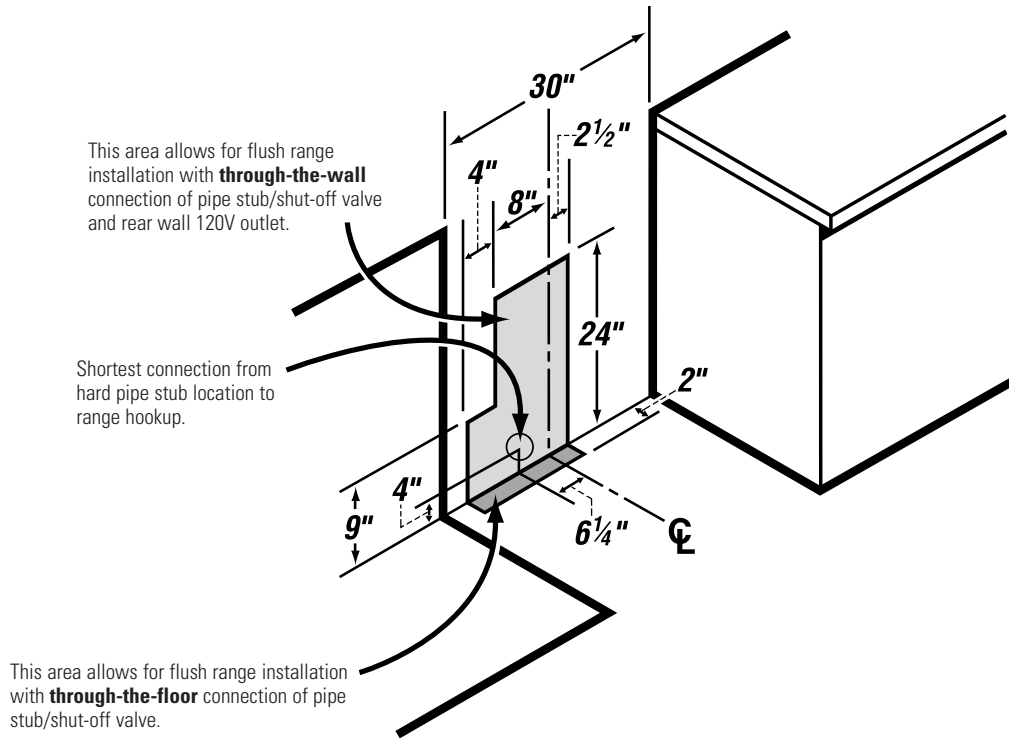

## GAS PIPE AND ELECTRICAL OUTLET LOCATIONS (for models with Standard Twin Burners)

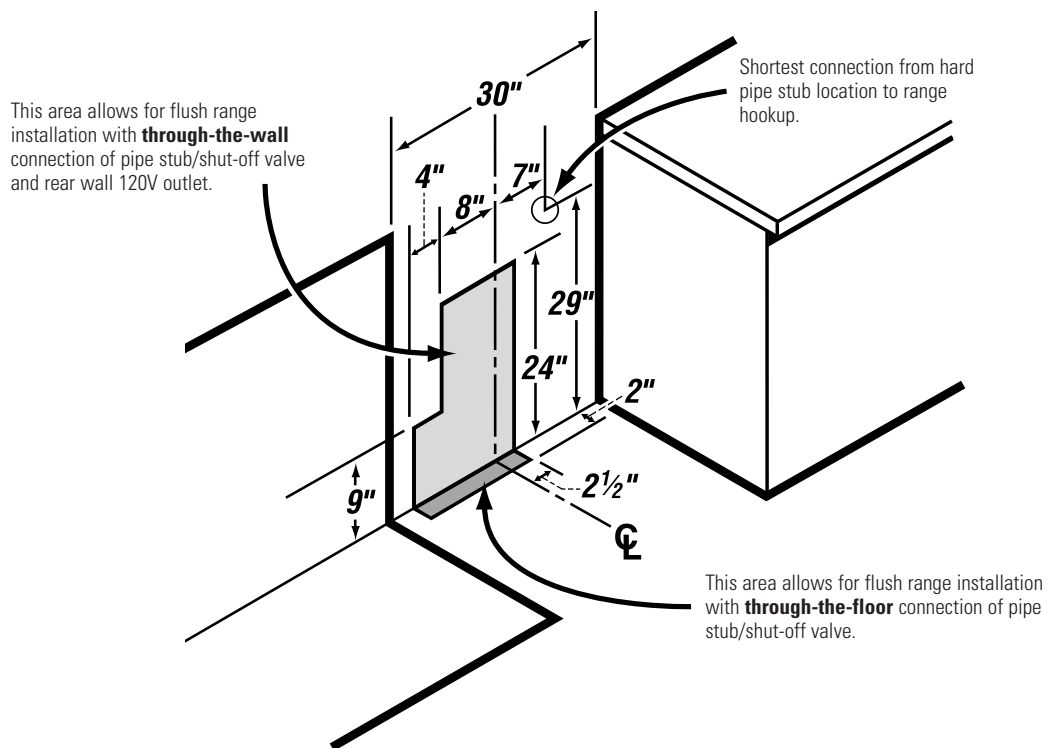



# Installation Instructions

## FLEXIBLE CONNECTOR HOOKUP (for models equipped with Sealed Burners)

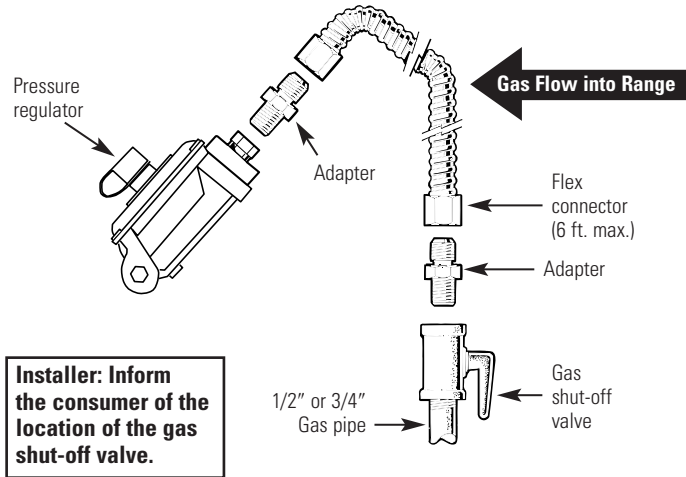

**Installer: Inform the consumer of the location of the gas shut-off valve.**

## RIGID PIPE HOOKUP OPTIONS (for models equipped with Sealed Burners)

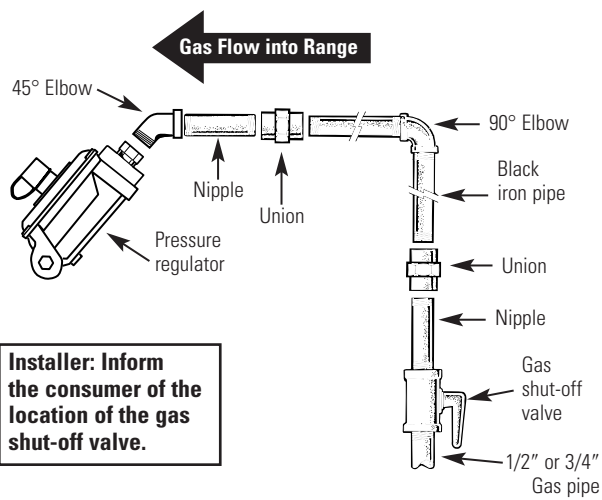

**Installer: Inform the consumer of the location of the gas shut-off valve.**

### Alternate Hookup

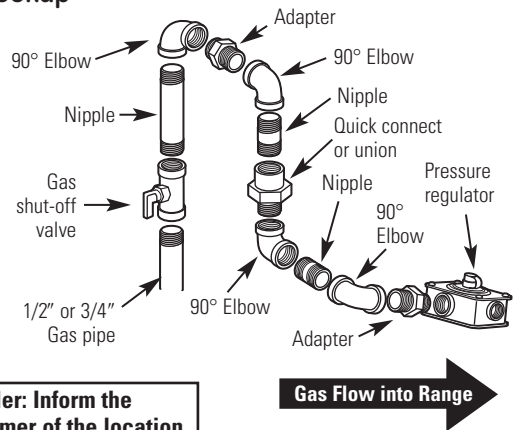

**Installer: Inform the consumer of the location of the gas shut-off valve.**

# Installation Instructions

## FLEXIBLE CONNECTOR HOOKUP (for models equipped with Standard Twin Burners)

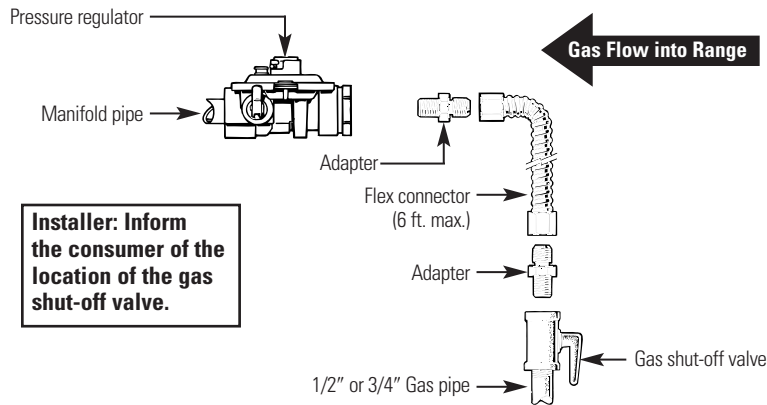

## RIGID PIPE HOOKUP (for models equipped with Standard Twin Burners)

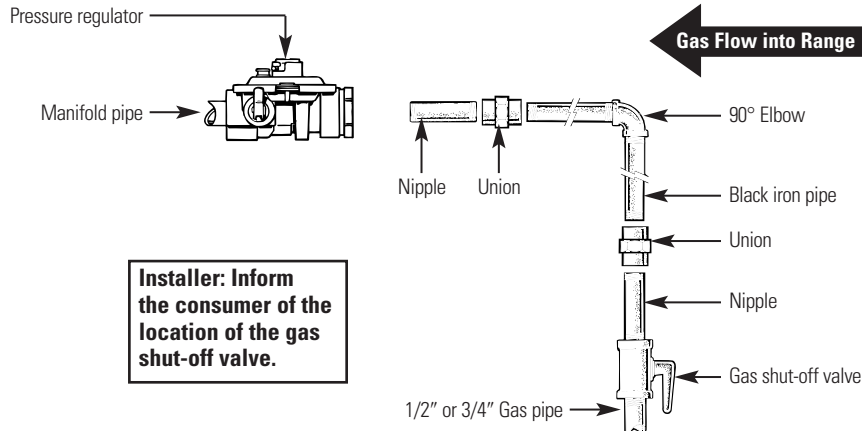

# Installation Instructions

## 3 ELECTRICAL CONNECTIONS

### Electrical Requirements

120-volt, 60 Hertz, properly grounded branch circuit protected by a 15-amp or 20-amp circuit breaker or time-delay fuse.

### Extension Cord Cautions

Because of potential safety hazards associated with certain conditions, we strongly recommend against the use of an extension cord. However, if you still elect to use an extension cord, it is absolutely necessary that it be a UL-listed, 3-wire grounding-type appliance extension cord and that the current carrying rating of the cord in amperes be equivalent to, or greater than, the branch circuit rating.

### Grounding

**IMPORTANT—(Please read carefully)**

**FOR PERSONAL SAFETY, THIS APPLIANCE MUST BE PROPERLY GROUNDED.**

#### Preferred Method

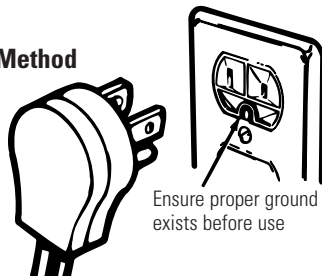

The power cord of this appliance is equipped with a 3-prong (grounding) plug which mates with a standard 3-prong grounding wall receptacle to minimize the possibility of electric shock hazard from this appliance.

The customer should have the wall receptacle and circuit checked by a qualified electrician to make sure the receptacle is properly grounded.

Where a standard 2-prong wall receptacle is encountered, it is the personal responsibility and obligation of the customer to have it replaced with a properly grounded 3-prong wall receptacle.

**DO NOT, UNDER ANY CIRCUMSTANCES, CUT OR REMOVE THE THIRD (GROUND) PRONG FROM THE POWER CORD.**

**A word about GFCIs – GFCIs are not required or recommended for gas range receptacles.**

Ground Fault Circuit Interrupters (GFCIs) are devices that sense leakage of current in a circuit and automatically switch off power when a threshold leakage level is detected. These devices must be manually reset by the consumer. The National Electrical Code requires the use of GFCIs in kitchen receptacles installed to serve countertop surfaces. Performance of the range will not be affected if operated on a GFCI-protected circuit but occasional nuisance tripping of the GFCI breaker is possible.

## 3 ELECTRICAL CONNECTIONS (CONT.)

### A. Usage Situations Where Appliance Power Cord Will Be Disconnected Infrequently.

An adapter may be used only on a 15-amp circuit. Do not use an adapter on a 20-amp circuit. Where local codes permit, a **TEMPORARY CONNECTION** may be made to a properly grounded 2-prong wall receptacle by the use of a UL-listed adapter, available at most hardware stores. The larger slot in the adapter must be aligned with the larger slot in the wall receptacle to provide proper polarity in the connection of the power cord.

#### Temporary Method

(Adapter plugs not permitted in Canada)

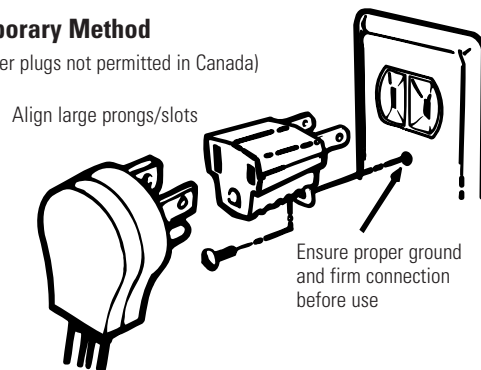

**⚠ CAUTION:** Attaching the adapter ground terminal to the wall receptacle cover screw does not ground the appliance unless the cover screw is metal, and not insulated, and the wall receptacle is grounded through the house wiring. The customer should have the circuit checked by a qualified electrician to make sure the receptacle is properly grounded.

When disconnecting the power cord from the adapter, always hold the adapter with one hand. If this is not done, the adapter ground terminal is very likely to break with repeated use. Should this happen, **DO NOT USE** the appliance until a proper ground has again been established.

# Installation Instructions

## 3 ELECTRICAL CONNECTIONS (CONT.)

### B. Usage Situations Where Appliance Power Cord Will Be Disconnected Frequently.

Do not use an adapter plug in these situations because disconnecting of the power cord places undue strain on the adapter and leads to eventual failure of the adapter ground terminal. The customer should have the 2-prong wall receptacle replaced with a 3-prong (grounding) receptacle by a qualified electrician before using the appliance.

The installation of appliances designed for mobile home installation must conform with the Manufactured Home Construction and Safety Standard, Title 24 CFR, Part 3280 (formerly the Federal Standard for Mobile Home Construction and Safety, Title 24, HUD, Part 280) or, when such standard is not applicable, the Standard for Manufactured Home Installations, latest edition (Manufactured Home Sites, Communities and Set-Ups), ANSI A225.1, latest edition, or with local codes. In Canada, mobile home installation must be in accordance with the current CAN/CSA Z240/MH Mobile Home Installation Code.

### Electric Disconnect

- Locate disconnect plug on the range back.
- Pinch sides of connector and pull out of range back.

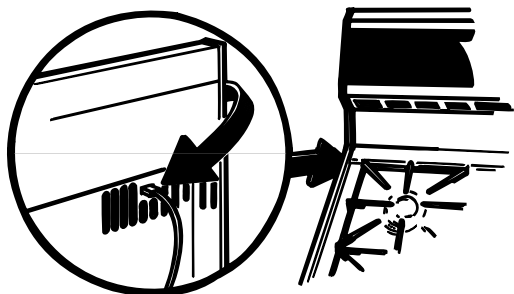

## 4 SEAL THE OPENINGS

Seal any openings in the wall behind the range and in the floor under the range when hookups are completed.

## 5 CHECK IGNITION OF SURFACE BURNERS

Operation of all cooktop and oven burners should be checked after the range and gas supply lines have been carefully checked for leaks.

### Electric Ignition Models

Select a top burner knob and simultaneously push in and turn to **LITE** position. You will hear a **clicking** sound indicating proper operation of the spark module. Once the air has been purged from the supply lines, burners should light within 4 seconds. After burner lights, rotate knob out of the **LITE** position. Try each burner in succession until all burners have been checked.

### Quality of Flames

The combustion quality of burner flames needs to be determined visually.



**(A) Yellow flames—**  
Call for service

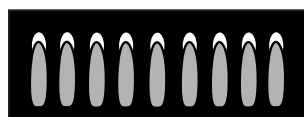

**(B) Yellow tips on  
outer cones—**  
Normal for LP gas



**(C) Soft blue  
flames—**Normal  
for natural gas

If burner flames look like (A), call for service. Normal burner flames should look like (B) or (C), depending on the type of gas you use.

With LP gas, some yellow tipping on outer cones is normal.

## 6 CHECK IGNITION OF OVEN BURNER

The oven is designed to operate quietly and automatically. To operate the oven, press the **Bake** pad and then press the number pads until **350°** appears in the display. Touch the **Start/On** pad. After 30–90 seconds, the oven burner will ignite and burn until the set temperature is reached. The oven burner will continue to cycle on and off as necessary to maintain the oven at the temperature indicated by the display.

To check ignition of the broil burner, touch the **Broil Hi/Lo** pad and then the **Start/On** pad. After 30–90 seconds, the broil burner will ignite.

**Electric ignition models** require electrical power to operate. In case of a power outage, the oven burners on these models cannot be lit manually with a match. Gas will not flow unless the glow bar is hot.

If the oven is in use when a power outage occurs, the burner will shut off and cannot be relit until power is restored.

# Installation Instructions

## 7 ADJUST BROIL AND OVEN BURNER AIR ADJUSTMENT SHUTTERS IF NECESSARY

Air adjustment shutters for the top and bottom burners regulate the flow of air to the flames.

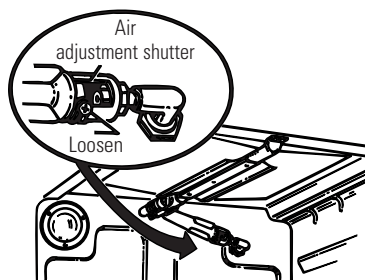

The air adjustment shutter for the top (broil) burner is in the center of the rear wall of the oven.

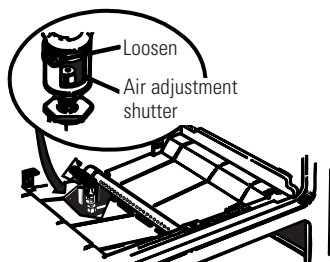

The shutter for the bottom (oven) burner is near the back wall behind the warming drawer, storage drawer or kick panel. Remove the drawer or panel. See the *Care and cleaning of the range* section.

To adjust the flow of air to either burner, loosen the Phillips-head screw and rotate the shutter toward open or closed position as needed.

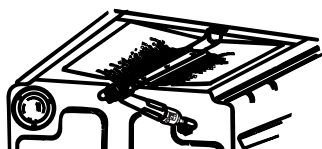

The flames for the top (broil) burner should be steady with approximately 1" blue cones and should not extend out over the edges of the burner baffle.

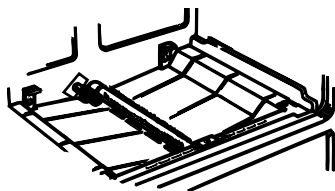

To determine if the bottom burner flames are burning properly, remove the oven bottom. Flames should have approximately 1" blue cones and, if range is supplied with natural gas, should burn with no yellow tipping. (With most LP gas, small yellow tips at the end of outer cones are normal.) Flames should not lift off burner ports. If lifting is observed, gradually reduce air shutter opening until flames are stabilized.

## 7 ADJUST BROIL AND OVEN BURNER AIR ADJUSTMENT SHUTTERS IF NECESSARY (CONT.)

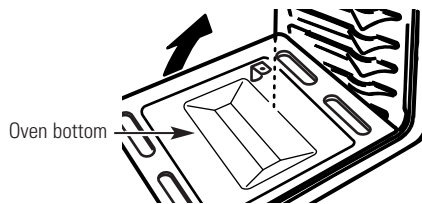

To remove the oven bottom:

- Remove the screws holding down the rear of the oven bottom.
- Grasp the oven bottom at finger slots on each side.
- Lift the rear of the oven bottom enough to clear the lip of the range frame, push it back, and then pull it up and out.

## 8 LEVELING THE RANGE

- Install the oven racks in the oven and position the range where it will be installed.

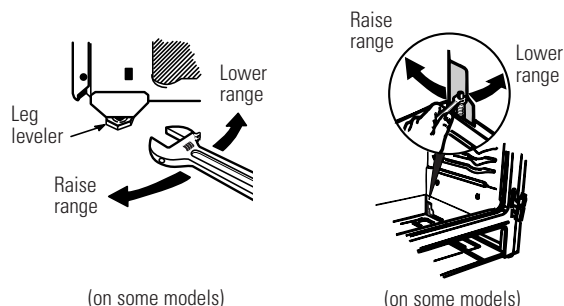

- Check for levelness by placing a spirit level or a cup, partially filled with water, on one of the oven racks. If using a spirit level, take two readings—with the level placed diagonally first in one direction and then the other.
- Remove the storage drawer or kick panel. See the *Care and cleaning of the range* section. The front leveling legs can be adjusted from the bottom and the rear legs can be adjusted from the top or the bottom.
- Use an open-end or adjustable wrench to adjust the leveling legs until the range is level.
- After the range is level, slide the range away from the wall so that the Anti-Tip device can be installed.

# Installation Instructions

## 9 INSTALLING THE ANTI-TIP DEVICE

### ⚠ WARNING!

- Range must be secured with an approved Anti-Tip device.
- Unless properly installed, the range could be tipped by you or a child standing, sitting or leaning on an open door.
- After installing the Anti-Tip device, verify that it is in place by carefully attempting to tilt the range forward.
- This range has been designed to meet all recognized industry tip standards for all normal conditions.
- The use of this device does not preclude tipping of the range when not properly installed.
- If the Anti-Tip Device supplied with the range does not fit this application, use the Anti-Tip Device WB2X7909.

- A. Mark the wall where the **RIGHT EDGE** of the range is to be located. Be sure to allow for the countertop overhang if you intend to install the range next to cabinets.

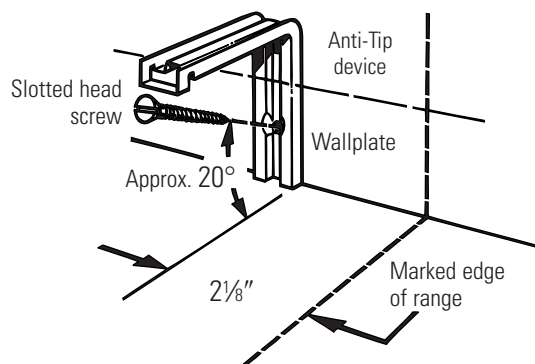

- B. Locate the outside edge of the device  $2\frac{1}{8}$ " toward the center of the range from the marked edge of the range.
- C. Using the device as a template, mark the position of the hole for the screw.
- D. For wood construction, drill a pilot hole at an angle of 20 degrees from the horizontal. A nail or awl may be used if a drill is not available.

Mount the Anti-Tip device with the screw provided.

For cement or concrete construction, you will need a  $\frac{1}{4}$ " x  $1\frac{1}{2}$ " lag bolt and a  $\frac{1}{2}$ " O.D. sleeve anchor, which are not provided. Drill the recommended size hole for the hardware.

## 9 INSTALLING THE ANTI-TIP DEVICE (CONT.)

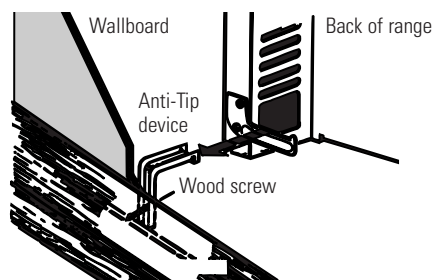

Install the sleeve anchor into the drilled hole and then install the lag bolt through the device. The bolts must be properly tightened as recommended for the hardware.

- E. Slide the range against the wall, and check for proper installation by grasping the front edge of the cooktop and carefully attempting to tilt the range forward. The bracket should stop the range within 4 inches. If it does not, the bracket must be reinstalled.

## WHEN ALL HOOKUPS ARE COMPLETED

Make sure all controls are left in the off position. Make sure the flow of combustion and ventilation air to the range is unobstructed.

## CONVERTING TO LP GAS (or converting back to natural gas from LP)

This range leaves the factory set for use with natural gas. If you want to convert to LP gas, the conversion must be performed by a qualified LP gas installer.

The conversion instructions and LP orifices can be found attached to the range next to the pressure regulator.

Keep these instructions and the orifices in case you want to convert back to natural gas.





**Troubleshooting Tips**  
Save time and money! Review the charts on the following pages first and you may not need to call for service.

Problem	Possible Causes	What To Do
<b>Top burners do not light or do not burn evenly</b>	<b>Plug on range is not completely inserted in the electrical outlet.</b>	<ul style="list-style-type: none"> <li>Make sure electrical plug is plugged into a live, properly grounded outlet.</li> </ul>
	<b>Burner hole or slits on the side of the burner may be clogged.</b>	<ul style="list-style-type: none"> <li>Remove the burners (on models with standard twin burners) or burner heads and caps (on models with sealed burners) and clean them with a sewing needle or twist-tie. Make sure you do not enlarge the holes. On sealed burner models, check and clean the electrode area for burned-on food or grease.</li> </ul>
	<b>Improper burner assembly.</b>	<ul style="list-style-type: none"> <li>Make sure the burner parts are installed correctly. See the <i>Care and cleaning of the range</i> section.</li> </ul>
<b>Burner flames very large or yellow</b>	<b>Improper air to gas ratio.</b>	<ul style="list-style-type: none"> <li>If range is connected to LP gas, contact the person who installed your range or made the conversion.</li> </ul>
<b>Surface burners light but oven does not</b>	<b>The oven gas shut-off valve may have accidentally been moved during cleaning or moving.</b>	<ul style="list-style-type: none"> <li>To check the oven gas shut-off valve on sealed burner models, remove the warming drawer, storage drawer or kick panel (see the <i>Care and cleaning of the range</i> section) and look for the gas shut-off lever at the back of the range.</li> </ul>
		<div data-bbox="824 995 1117 1222" data-label="Image"> <p><b>Sealed burner models</b></p> </div> <ul style="list-style-type: none"> <li>To check the oven gas shut-off valve on standard twin burner models, raise the cooktop and look for the gas shut-off lever at the extreme right rear corner. Follow the directions in box <b>A</b> or <b>B</b> that match your regulator type.</li> </ul> <div data-bbox="824 1415 1117 1642" data-label="Image"> <p><b>Standard twin burner models</b></p> </div> <div data-bbox="1146 1415 1438 1642" data-label="Image"> <p><b>Standard twin burner models</b></p> </div>
<b>Control signals after entering cooking time or start time (on some models)</b>	<b>You forgot to enter a bake temperature or cleaning time.</b>	<ul style="list-style-type: none"> <li>Touch the <b>Bake</b> pad and desired temperature or the <b>Self Clean</b> pad and desired clean time.</li> </ul>
<b>Clock and timer do not work (on some models)</b>	<b>Plug on range is not completely inserted in the electrical outlet.</b>	<ul style="list-style-type: none"> <li>Make sure electrical plug is plugged into a live, properly grounded outlet.</li> </ul>
	<b>A fuse in your home may be blown or the circuit breaker tripped.</b>	<ul style="list-style-type: none"> <li>Replace the fuse or reset the circuit breaker.</li> </ul>
	<b>Oven controls improperly set.</b>	<ul style="list-style-type: none"> <li>See the <i>Using the clock and timer</i> section.</li> </ul>

## Before you call for service...



### Troubleshooting Tips

Problem	Possible Causes	What To Do
Food does not bake or roast properly	Oven controls improperly set.	• See the <i>Using the oven</i> section.
	Rack position is incorrect.	• See the <i>Using the oven</i> section.
	Incorrect cookware or cookware of improper size being used.	• See the <i>Using the oven</i> section.
	Oven thermostat needs adjustment.	• See the <i>Adjust the oven thermostat—Do it yourself!</i> section.
	Clock not set correctly. (on some models)	• See the <i>Using the clock and timer</i> section.
	Aluminum foil used improperly in the oven.	• See the <i>Care and cleaning of the range</i> section.
	Oven bottom not securely seated in position.	• See the <i>Installation of the range</i> section.
Food does not broil properly	Oven controls improperly set.	• On models with touch pads, make sure you touch the <b>Broil Hi/Lo</b> pad. On models with an <b>OVEN TEMP</b> knob, make sure it is set at BROIL.
	Oven door not closed.	• See the <i>Using the oven</i> section.
	Improper rack position being used.	• See the <i>Broiling Guide</i> .
	Food being cooked in a hot pan.	• For best results, use a pan designed for broiling. Make sure it is cool.
	Cookware not suited for broiling.	• For best results, use a pan designed for broiling.
Oven temperature too hot or too cold	Oven thermostat needs adjustment.	• See the <i>Adjust the oven thermostat—Do it yourself!</i> section.
	Oven light does not work	Light bulb is loose or defective. • Tighten or replace the bulb. Plug on range is not completely inserted in the electrical outlet. • Make sure electrical plug is plugged into a live, properly grounded outlet.
Oven will not self-clean	The oven temperature is too high to set a self-clean operation.	• Allow the range to cool to room temperature and reset the controls.
	Oven controls improperly set.	• See the <i>Using the self-cleaning oven</i> section.
	On models with a door latch, the oven door is not in the locked position.	• Make sure you move the door latch handle all the way to the right.
"Crackling" or "popping" sound	This is the sound of the metal heating and cooling during both the cooking and cleaning functions.	• This is normal.

<b>Problem</b>	<b>Possible Causes</b>	<b>What To Do</b>
<i>Excessive smoking</i>	<b>Excessive soil.</b>	<ul style="list-style-type: none"> <li>On models with touch pads, touch the <b>Clear/Off</b> pad. On models with an <b>OVEN TEMP</b> knob, turn it to OFF. Open the windows to rid the room of smoke. Wait until the <b>SELF CLEAN</b> light goes off. Wipe up the excess soil and reset the clean cycle.</li> </ul>
<i>Oven door will not open after a clean cycle</i>	<b>Oven too hot.</b>	<ul style="list-style-type: none"> <li>Allow the oven to cool below locking temperature.</li> </ul>
<i>Oven not clean after a clean cycle</i>	<b>Oven controls not properly set.</b>	<ul style="list-style-type: none"> <li>See the <i>Using the self-cleaning oven</i> section.</li> </ul>
	<b>Oven was heavily soiled.</b>	<ul style="list-style-type: none"> <li>Clean up heavy spillovers before starting the clean cycle. Heavily soiled ovens may need to self-clean again or for a longer period of time.</li> </ul>
<i>Oven door will not unlock (on models with a door latch)</i>	<b>Oven is too hot.</b>	<ul style="list-style-type: none"> <li>Allow the oven to cool below locking temperature. Do not lock the door with the door latch except when using the self-clean feature.</li> </ul>
<i>Self-clean light (on some models) blinks when trying to set a self-clean cycle</i>	<b>The OVEN TEMP knob has not been set to CLEAN when the latch was moved to the right.</b>	<ul style="list-style-type: none"> <li>Set the <b>OVEN TEMP</b> knob to <b>CLEAN</b>. See the <i>Using the self-cleaning oven</i> section.</li> </ul>
	<b>The latch was not moved to the right when the OVEN TEMP knob was set to CLEAN.</b>	<ul style="list-style-type: none"> <li>Move the latch to the right as far as it will go. See the <i>Using the self-cleaning oven</i> section.</li> </ul>
<i>Self-clean light (on some models) blinks during self-clean cycle</i>	<b>A power interruption occurred.</b>	<ul style="list-style-type: none"> <li>Turn the <b>OVEN TEMP</b> knob to <b>OFF</b> and move the latch to the left as far as it will go. Reset the range controls to the desired settings. See the <i>Using the self-cleaning oven</i> section.</li> </ul>
<i>"Door" appears in the display (on some models)</i>	<b>Self-cleaning cycle has been selected but the latch handle was not moved all the way to the right.</b>	<ul style="list-style-type: none"> <li>Move the latch handle all the way to the right.</li> </ul>
	<b>Latch handle was moved to the right but a program other than self-cleaning was selected.</b>	<ul style="list-style-type: none"> <li>Move the latch handle to the right only when setting the self-cleaning cycle.</li> </ul>
<i>"F—" and a number or letter flash in the display (on some models)</i>	<b>On models with a door latch, if a function error code appears during the self-cleaning cycle, check the oven door latch.</b>	<ul style="list-style-type: none"> <li>The latch may have been moved, even if only slightly, from the locked position. Make sure the latch is moved to the right as far as it will go.</li> </ul>
	<b>You have a function error code.</b>	<ul style="list-style-type: none"> <li>Touch the <b>Clear/Off</b> pad. Allow the oven to cool for one hour. Put the oven back into operation.</li> </ul>
	<b>If the function code repeats.</b>	<ul style="list-style-type: none"> <li>Disconnect all power to the range for 5 minutes and then reconnect power. If the function error code repeats, call for service.</li> </ul>

Safety Instructions

Operating Instructions

Care and Cleaning

Installation Instructions

Troubleshooting Tips

Consumer Support

## Before you call for service...



### Troubleshooting Tips

Problem	Possible Causes	What To Do
<b>Display goes blank</b> <i>(on some models)</i>	A fuse in your home may be blown or the circuit breaker tripped.	<ul style="list-style-type: none"> <li>Replace the fuse or reset the circuit breaker.</li> </ul>
	The clock is turned off so that it does not show in the display.	<ul style="list-style-type: none"> <li>See the <i>Using the clock and timer</i> section.</li> </ul>
<b>Display flashes</b> <i>(on some models)</i>	Power failure.	<ul style="list-style-type: none"> <li>Reset the clock.</li> </ul>
<b>Unable to get the display to show "SF"</b> <i>(on some models)</i>	Oven control pads were not touched properly.	<ul style="list-style-type: none"> <li>The <b>Bake</b> and <b>Broil Hi/Lo</b> pads must be touched at the same time and held for 3 seconds.</li> </ul>
<b>Power outage, clock flashes</b> <i>(on some models)</i>	Power outage or surge.	<ul style="list-style-type: none"> <li>Reset the clock. If the oven was in use, you must reset it by touching the <b>Clear/Off</b> pad, setting the clock and resetting any cooking function.</li> </ul>
<b>"Burning" or "oily" odor emitting from the vent</b>	This is normal in a new oven and will disappear in time.	<ul style="list-style-type: none"> <li>To speed the process, set a self-clean cycle for a minimum of 3 hours. See the <i>Using the self-cleaning oven</i> section.</li> </ul>
<b>Strong odor</b>	An odor from the insulation around the inside of the oven is normal for the first few times the oven is used.	<ul style="list-style-type: none"> <li>This is temporary.</li> </ul>
<b>Fan noise</b>	A cooling fan may automatically turn on and off to cool internal parts.	<ul style="list-style-type: none"> <li>This is normal. The cooling fan will turn off and on.</li> </ul>
<b>Drawer does not slide smoothly or drags</b>	The drawer is out of alignment.	<ul style="list-style-type: none"> <li>Fully extend the drawer and push it all the way in. See the <i>Care and cleaning of the range</i> section.</li> </ul>
	Drawer is overloaded or load is unbalanced.	<ul style="list-style-type: none"> <li>Reduce weight. Redistribute drawer contents.</li> </ul>



## Looking For Something More?

You can find these accessories and many more at **GEAppliances.com** (U.S.) or **www.GEAppliances.ca** (Canada), or call **800.626.2002** (U.S.) or **800.661.1616** (Canada) (during normal business hours). Have your model number ready.

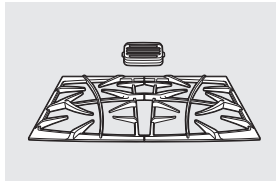

Grates

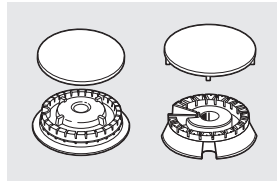

Surface Burner Heads and Caps

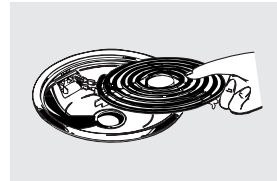

Surface Elements and Drip Pans

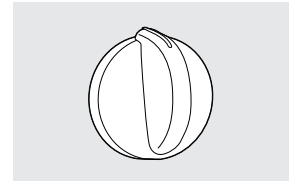

Knobs

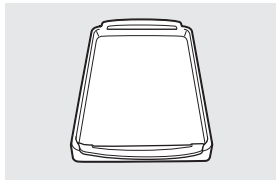

Griddle

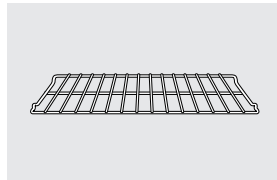

Oven Racks

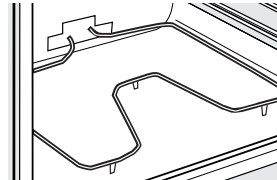

Oven Elements

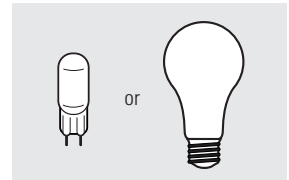

Light Bulbs

## Experience these other great products to keep your kitchen looking great!



**Ceramic Cooktop Cleaning Kit:**  
Includes cleaner, scraper and pad

WX10X117GCS



**Ceramic Cooktop Cleaning Wipes**

WX10X305



**Stainless Steel Appliance Polish Wipes**

WX10X10001



**Stainless Steel Appliance Cleaner**

PM10X311

## Get the most out of your Broiler Pan! (Not for use with Broiler Drawer models.)

Use your pan and grid cover to broil hamburgers, seafood, steaks, vegetables, bacon, chops and so much more! The pan below catches the excess fats and oils.

- Genuine GE Part
- Easy To Clean
- One-Year Warranty

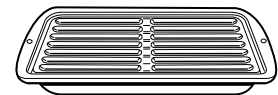

## Limited Time Offer! Free Shipping!

When you order your broiler pan **within 30 days** of purchasing your GE cooking product.

	Small	Large*	XL**
<b>U.S. Part #</b>	WB48X10055	WB48X10056	WB48X10057
<b>Canada Part #</b>	222D2097G001	222D2097G002	N/A
<b>Dimensions</b>	8-3/4" W x 1-1/4" H x 13-1/2" D	12-3/4" W x 1-1/4" H x 16-1/2" D	17" W x 1-1/4" H x 19-1/4" D
<b>Price</b>	<b>US\$10.50<sup>†</sup></b>	<b>US\$14.50<sup>†</sup></b>	<b>US\$16.75<sup>†</sup></b>

<sup>†</sup> Plus applicable state sales tax (PST/HST and GST)

\* The large (standard) broil pan does not fit in 20"/24" ranges.

\*\* The XL pan does not fit in 24" wall ovens, 27" drop-ins or 20"/24" ranges.

To place your order, call **800.626.2002** (U.S.), **800.661.1616** (Canada) or mail this form to:

**In the U.S.:** GE Parts, P.O. Box 221027, Memphis, TN 38122-1027. **In Canada:** GE Parts, 1 Factory Lane, Moncton, N.B. E1C 9M3



## Broiler Pan Order Form

Quantity \_\_\_\_\_ Part Number \_\_\_\_\_  
 \_\_\_\_\_  
 \_\_\_\_\_

Model Number \_\_\_\_\_ Serial Number \_\_\_\_\_ Brand \_\_\_\_\_ Date of Purchase \_\_\_\_\_

First Name \_\_\_\_\_ Last Name \_\_\_\_\_

Address \_\_\_\_\_

City \_\_\_\_\_ State \_\_\_\_\_ Zip Code \_\_\_\_\_

Phone \_\_\_\_\_ E-Mail \_\_\_\_\_

Credit Card  Check  Money Order

Visa  MasterCard  Discover  AmEx  Credit Card # \_\_\_\_\_

Exp. Date: Month \_\_\_\_\_ Year \_\_\_\_\_ Signature: \_\_\_\_\_

## GE Gas Range Warranty. *(For customers in the United States)*



All warranty service provided by our Factory Service Centers, or an authorized Customer Care® technician. To schedule service, visit us on-line at [GEAppliances.com](http://GEAppliances.com), or call 800.GE.CARES (800.432.2737). Please have serial number and model number available when calling for service.

Staple your receipt here.  
Proof of the original purchase date is needed to obtain service under the warranty.

### For The Period Of: **GE Will Replace:**

#### One Year

From the date of the original purchase

**Any part** of the range which fails due to a defect in materials or workmanship. During this **limited one-year warranty**, GE will also provide, **free of charge**, all labor and in-home service to replace the defective part.

### What GE Will Not Cover:

- Service trips to your home to teach you how to use the product.
- Damage to the product caused by accident, fire, floods or acts of God.
- Improper installation, delivery or maintenance.
- Incidental or consequential damage caused by possible defects with this appliance.
- Failure of the product if it is abused, misused, or used for other than the intended purpose or used commercially.
- Damage caused after delivery.
- Replacement of house fuses or resetting of circuit breakers.
- Product not accessible to provide required service.

**EXCLUSION OF IMPLIED WARRANTIES—Your sole and exclusive remedy is product repair as provided in this Limited Warranty. Any implied warranties, including the implied warranties of merchantability or fitness for a particular purpose, are limited to one year or the shortest period allowed by law.**

This warranty is extended to the original purchaser and any succeeding owner for products purchased for home use within the USA. If the product is located in an area where service by a GE Authorized Servicer is not available, you may be responsible for a trip charge or you may be required to bring the product to an Authorized GE Service Location for service. In Alaska, the warranty excludes the cost of shipping or service calls to your home.

Some states do not allow the exclusion or limitation of incidental or consequential damages. This warranty gives you specific legal rights, and you may also have other rights which vary from state to state. To know what your legal rights are, consult your local or state consumer affairs office or your state's Attorney General.

Warrantor: General Electric Company, Louisville, KY 40225



# GE Gas Range Warranty. *(For customers in Canada)*



All warranty service provided by our Factory Service Centres or an authorized Customer Care® technician. For service, call 1.800.561.3344. Please have serial number and model number available when calling for service.

Staple your receipt here.  
Proof of the original purchase date is needed to obtain service under the warranty.

## For The Period Of: **Mabe Will Replace:**

### One Year

From the date of the original purchase

**Any part** of the range which fails due to a defect in materials or workmanship. During this **limited one-year warranty**, Mabe will also provide, **free of charge**, all labor and in-home service to replace the defective part.

## What Mabe Will Not Cover:

- Service trips to your home to teach you how to use the product.
- Replacement of house fuses or resetting of circuit breakers.
- Improper installation, delivery or maintenance.
- Damage to the product caused by accident, fire, floods or acts of God.
- Failure of the product if it is abused, misused, or used for other than the intended purpose or used commercially.
- Incidental or consequential damage caused by possible defects with this appliance.
- Damage caused after delivery.
- Product not accessible to provide required service.

**EXCLUSION OF IMPLIED WARRANTIES—Your sole and exclusive remedy is product repair as provided in this Limited Warranty. Any implied warranties, including the implied warranties of merchantability or fitness for a particular purpose, are limited to one year or the shortest period allowed by law.**

This warranty is extended to the original purchaser and any succeeding owner for products purchased in Canada for home use within Canada. In-home warranty service will be provided in areas where it is available and deemed reasonable by Mabe to provide.

Some provinces do not allow the exclusion or limitation of incidental or consequential damages, so the above exclusion may not apply to you. This warranty gives you specific legal rights, and you may also have other rights which vary from province to province. To know what your legal rights are in your province, consult your local provincial consumer affairs office.

**Warrantor: Mabe Canada Inc.  
Burlington, Ontario**

Safety Instructions

Operating Instructions

Care and Cleaning

Installation Instructions

Troubleshooting Tips

Consumer Support

# Consumer Support.

---



## GE Appliances Website

In the U.S.: **GEAppliances.com**

Have a question or need assistance with your appliance? Try the GE Appliances Website 24 hours a day, any day of the year! For greater convenience and faster service, you can now download Owner's Manuals, order parts or even schedule service on-line. **In Canada: [www.GEAppliances.ca](http://www.GEAppliances.ca)**



## Schedule Service

In the U.S.: **GEAppliances.com**

Expert GE repair service is only one step away from your door. Get on-line and schedule your service at your convenience any day of the year! Or call 800.GE.CARES (800.432.2737) during normal business hours.

**In Canada, call 1.800.561.3344**



## Real Life Design Studio

In the U.S.: **GEAppliances.com**

GE supports the Universal Design concept—products, services and environments that can be used by people of all ages, sizes and capabilities. We recognize the need to design for a wide range of physical and mental abilities and impairments. For details of GE's Universal Design applications, including kitchen design ideas for people with disabilities, check out our Website today. For the hearing impaired, please call 800.TDD.GEAC (800.833.4322).

**In Canada, contact:** Manager, Consumer Relations, Mabe Canada Inc.  
Suite 310, 1 Factory Lane  
Moncton, N.B. E1C 9M3



## Extended Warranties

In the U.S.: **GEAppliances.com**

Purchase a GE extended warranty and learn about special discounts that are available while your warranty is still in effect. You can purchase it on-line anytime, or call 800.626.2224 during normal business hours. GE Consumer Home Services will still be there after your warranty expires. **In Canada, call 1.888.261.2133**

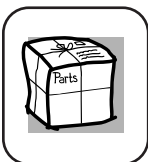

## Parts and Accessories

In the U.S.: **GEAppliances.com**

Individuals qualified to service their own appliances can have parts or accessories sent directly to their homes (VISA, MasterCard and Discover cards are accepted). Order on-line today, 24 hours every day or by phone at 800.626.2002 during normal business hours.

**Instructions contained in this manual cover procedures to be performed by any user. Other servicing generally should be referred to qualified service personnel. Caution must be exercised, since improper servicing may cause unsafe operation.**

Customers **in Canada** should consult the yellow pages for the nearest Mabe service center, or call 1.800.661.1616.



## Contact Us

In the U.S.: **GEAppliances.com**

If you are not satisfied with the service you receive from GE, contact us on our Website with all the details including your phone number, or write to:

General Manager, Customer Relations  
GE Appliances, Appliance Park  
Louisville, KY 40225

**In Canada: [www.GEAppliances.ca](http://www.GEAppliances.ca), or write to:** Director, Consumer Relations, Mabe Canada Inc.  
Suite 310, 1 Factory Lane  
Moncton, N.B. E1C 9M3



## Register Your Appliance

In the U.S.: **GEAppliances.com**

**Register your new appliance on-line—at your convenience!** Timely product registration will allow for enhanced communication and prompt service under the terms of your warranty, should the need arise. You may also mail in the pre-printed registration card included in the packing material. **In Canada: [www.GEAppliances.ca](http://www.GEAppliances.ca)**