



# Gas Slide-In Ranges

*Safety Instructions* .....2-7

***Operating Instructions***

Baking or Roasting .....12  
 Broiling, Broiling Guide .....14  
 Clock and Timer .....15  
 Control Lockout .....11  
 Cookware .....9  
 Oven .....10-21  
 Sabbath Feature .....18  
 Self-Cleaning .....20, 21  
 Special Features .....17  
 Surface Burners .....8, 9  
 Thermostat .....19  
 Timed Baking & Roasting .....16

***Care and Cleaning***

Broiler Pan and Grid .....24  
 Burner Assembly .....22  
 Burner Grates, Vent Grille  
 and Vent Grille Cap .....23  
 Control Panel .....26  
 Door .....25  
 Floor .....26  
 Knobs .....22

**Owner's Manual**

JGSP28

Lift-Off Oven Door .....25  
 Light Bulbs .....23, 24  
 Oven Vent and  
 Cooktop Air Inlet .....26  
 Packaging Tape .....22  
 Painted Surfaces .....26  
 Racks .....24  
 Stainless Steel Surfaces .....26  
 Storage Drawer .....24  
 Vent .....26

***Troubleshooting Tips*** .....27-30

***Accessories*** .....33

***Consumer Support***

Consumer Support ..... Back Cover  
 Product Registration .....31, 32  
 Warranty .....34

**Write the model and serial numbers here:**

**Model #** \_\_\_\_\_

**Serial #** \_\_\_\_\_

You can find them on a label behind the open oven door on the lower left corner of the range frame.



## IMPORTANT SAFETY INFORMATION. READ ALL INSTRUCTIONS BEFORE USING.



### **⚠ WARNING!** ANTI-TIP DEVICE

- ALL RANGES CAN TIP
- INJURY TO PERSONS COULD RESULT
- INSTALL ANTI-TIP DEVICES PACKED WITH RANGE
- SEE INSTALLATION INSTRUCTIONS

**⚠ WARNING:** If the information in this manual is not followed exactly, a fire or explosion may result causing property damage, personal injury or death.

— Do not store or use gasoline or other flammable vapors and liquids in the vicinity of this or any other appliance.

### — **WHAT TO DO IF YOU SMELL GAS**

- Do not try to light any appliance.
- Do not touch any electrical switch; do not use any phone in your building.
- Immediately call your gas supplier from a neighbor's phone. Follow the gas supplier's instructions.
- If you cannot reach your gas supplier, call the fire department.

— Installation and service must be performed by a qualified installer, service agency or the gas supplier.



# ⚠ WARNING!

For your safety, the information in this manual must be followed to minimize the risk of fire or explosion, electric shock, or to prevent property damage, personal injury, or loss of life.



## ANTI-TIP DEVICE

**All ranges can tip and injury could result.**

To prevent accidental tipping of the range, attach it to the wall or floor by installing the Anti-Tip device supplied.

If the Anti-Tip device supplied with the range does not fit this application, use the universal Anti-Tip device WB2X7909.

To check if the device is installed and engaged properly, remove the storage drawer and inspect the rear leveling leg. Make sure it fits securely into the slot.

If you pull the range out from the wall for any reason, make sure the device is properly engaged when you push the range back against the wall. If it is not, there is a possible risk of the range tipping over and causing injury if you or a child stand, sit or lean on an open door.

Please refer to the Anti-Tip device information in this manual. Failure to take this precaution could result in tipping of the range and injury.



## IMPORTANT SAFETY NOTICE

The California Safe Drinking Water and Toxic Enforcement Act requires the Governor of California to publish a list of substances known to the state to cause birth defects or other reproductive harm, and requires businesses to warn customers of potential exposure to such substances.

Gas appliances can cause minor exposure to four of these substances, namely benzene, carbon monoxide, formaldehyde and soot, caused primarily by the incomplete combustion of natural gas or LP fuels. Properly adjusted burners, indicated by a bluish rather than a yellow flame, will minimize incomplete combustion. Exposure to these substances can be minimized by venting with an open window or using a ventilation fan or hood.

The fiberglass insulation in self-clean ovens gives off a very small amount of carbon monoxide during the cleaning cycle. Exposure can be minimized by venting with an open window or using a ventilation fan or hood.

## IMPORTANT SAFETY INFORMATION. READ ALL INSTRUCTIONS BEFORE USING.

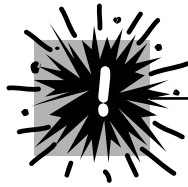

### **⚠ WARNING!**

#### SAFETY PRECAUTIONS

When using electrical appliances, basic safety precautions should be followed, including the following:

- Use this appliance only for its intended purpose as described in this Owner's Manual.
  - Be sure your appliance is properly installed and grounded by a qualified technician in accordance with the provided installation instructions.
  - Before performing any service, disconnect the range power supply at the household distribution panel by removing the fuse or switching off the circuit breaker.
  - Have the installer show you the location of the circuit breaker or fuse. Mark it for easy reference.
  - Do not leave children alone—children should not be left alone or unattended in an area where an appliance is in use. They should never be allowed to sit or stand on any part of the appliance.
  - Have the installer show you the location of the range gas shut-off valve and how to shut it off if necessary.
  - Have your range installed and properly grounded by a qualified installer, in accordance with the Installation Instructions. Any adjustment and service should be performed only by qualified gas range installers or service technicians.
  - Locate the range out of kitchen traffic path and out of drafty locations to prevent poor air circulation.
  - Be sure all packaging materials are removed from the range before operating it to prevent fire or smoke damage should the packaging material ignite.
  - Do not leave children alone or unattended where a range is hot or in operation. They could be seriously burned.
  - Do not attempt to repair or replace any part of your range unless it is specifically recommended in this manual. All other service should be referred to a qualified technician.
  - Be sure your range is correctly adjusted by a qualified service technician or installer for the type of gas (natural or LP) that is to be used. Your range can be converted for use with either type of gas. See the Installation Instructions packed with the range.
  - Plug your range into a 120-volt grounded outlet only. Do not remove the round grounding prong from the plug. If in doubt about the grounding of the home electrical system, it is your personal responsibility and obligation to have an ungrounded outlet replaced with a properly grounded, three-prong outlet in accordance with the National Electrical Code. Do not use an extension cord with this appliance.
- ⚠ WARNING:** *These adjustments must be made by a qualified service technician in accordance with the manufacturer's instructions and all codes and requirements of the authority having jurisdiction. Failure to follow these instructions could result in serious injury or property damage. The qualified agency performing this work assumes responsibility for the conversion.*
- Keep the hood and grease filters clean to maintain good venting and to avoid grease fires.
  - Teach children not to play with the controls or any other part of the range.
  - Always keep dish towels, dish cloths, pot holders and other linens a safe distance from your range.

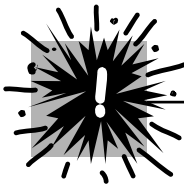

## SAFETY PRECAUTIONS

- Always keep wooden and plastic utensils and canned food a safe distance from your range.
- Always keep combustible wall coverings, curtains or drapes a safe distance from your range.
- Do not clean the range with flammable or volatile cleaning fluids.
- After prolonged use of a range, high floor temperatures may result and many floor coverings will not withstand this kind of use. Never install the range over vinyl tile or linoleum that cannot withstand such type of use. Never install it directly over interior kitchen carpeting.
- Do not allow anyone to climb, stand or hang on the oven door, storage drawer or cooktop. They could damage the range and even tip it over, causing severe personal injury.

**▲ CAUTION:** *Items of interest to children should not be stored in cabinets above a range or on the backsplash of a range—children climbing on the range to reach items could be seriously injured.*

**▲ WARNING:** **NEVER** use this appliance as a space heater to heat or warm the room. Doing so may result in carbon monoxide poisoning and overheating of the cooktop or oven.

- For your safety, never use your appliance for warming or heating the room.
- Large scratches or impacts to glass doors can lead to broken or shattered glass.
- Do not clean the range when the appliance is in use.
- Never wear loose-fitting or hanging garments while using the appliance. Be careful when reaching for items stored in cabinets over the range. Flammable material could be ignited if brought in contact with flame or hot oven surfaces and may cause severe burns.
- Do not store flammable materials in an oven, a range storage drawer or near a cooktop.
- Do not store or use combustible materials, gasoline or other flammable vapors and liquids in the vicinity of this or any other appliance.
- Do not let cooking grease or other flammable materials accumulate in or near the range.
- Do not use water on grease fires. Never pick up a flaming pan. Turn the controls off. Smother a flaming pan on a surface burner by covering the pan completely with a well-fitting lid, cookie sheet or flat tray. Use a multi-purpose dry chemical or foam-type fire extinguisher.

Flaming grease outside a pan can be put out by covering it with baking soda or, if available, by using a multi-purpose dry chemical or foam-type fire extinguisher.

Flame in the oven can be smothered completely by closing the oven door and turning the control to off or by using a multi-purpose dry chemical or foam-type fire extinguisher.

- Let the burner grates and other surfaces cool before touching them or leaving them where children can reach them.
- Never block the vents (air openings) of the range. They provide the air inlet and outlet that are necessary for the range to operate properly with correct combustion. Air openings are located through the rear and front center of the cooktop, at the top and bottom of the oven door, and at the bottom of the range under the storage drawer or kick panel.
- Do not lift the cooktop. Lifting the cooktop can lead to damage and improper operation of the range.

## IMPORTANT SAFETY INFORMATION. READ ALL INSTRUCTIONS BEFORE USING.



### **⚠ WARNING!** SURFACE BURNERS

Use proper pan size—avoid pans that are unstable or easily tipped. Select cookware having flat bottoms large enough to cover burner grates. To avoid spillovers, make sure cookware is large enough to contain the food properly. This will both save cleaning time and prevent hazardous accumulations of food, since heavy spattering or spillovers left on range can ignite. Use pans with handles that can be easily grasped and remain cool.

- Always use the **LITE** position when igniting the top burners and make sure the burners have ignited.
- Never leave the surface burners unattended at high flame settings. Boilovers cause smoking and greasy spillovers that may catch on fire.
- Adjust the top burner flame size so it does not extend beyond the edge of the cookware. Excessive flame is hazardous.
- Use only dry pot holders—moist or damp pot holders on hot surfaces may result in burns from steam. Do not let pot holders come near open flames when lifting cookware. Do not use a towel or other bulky cloth in place of a pot holder.
- When using glass cookware, make sure it is designed for top-of-range cooking.
- To minimize the possibility of burns, ignition of flammable materials and spillage, turn cookware handles toward the side or back of the range without extending over adjacent burners.
- Carefully watch foods being fried at a high flame setting.
- Always heat fat slowly, and watch as it heats.
- Do not leave any items on the cooktop. The hot air from the vent may ignite flammable items and will increase pressure in closed containers, which may cause them to burst.
- If a combination of oils or fats will be used in frying, stir together before heating or as fats melt slowly.
- Use a deep fat thermometer whenever possible to prevent overheating fat beyond the smoking point.
- Do not operate the burner without all burner parts in place.
- Use the least possible amount of fat for effective shallow or deep-fat frying. Filling the pan too full of fat can cause spillovers when food is added.
- When preparing flaming foods under the hood, turn the fan on.
- Do not use a wok on the cooking surface if the wok has a round metal ring that is placed over the burner grate to support the wok. This ring acts as a heat trap, which may damage the burner grate and burner head. Also, it may cause the burner to work improperly. This may cause a carbon monoxide level above that allowed by current standards, resulting in a health hazard.
- Foods for frying should be as dry as possible. Frost on frozen foods or moisture on fresh foods can cause hot fat to bubble up and over the sides of the pan.
- Never try to move a pan of hot fat, especially a deep fat fryer. Wait until the fat is cool.
- Do not leave plastic items on the cooktop—they may melt if left too close to the vent.
- Keep all plastics away from the surface burners.
- To avoid the possibility of a burn, always be certain that the controls for all burners are at the **OFF** position and all grates are cool before attempting to remove them.
- If range is located near a window, do not hang long curtains that could blow over the surface burners and create a fire hazard.
- If you smell gas, turn off the gas to the range and call a qualified service technician. Never use an open flame to locate a leak.
- Always turn the surface burner controls off before removing cookware.



## COOK MEAT AND POULTRY THOROUGHLY...

Cook meat and poultry thoroughly—meat to at least an INTERNAL temperature of 160°F and poultry to at least an INTERNAL temperature of 180°F. Cooking to these temperatures usually protects against foodborne illness.



## ⚠️ WARNING! OVEN

Stand away from the range when opening the oven door. Hot air or steam which escapes can cause burns to hands, face and/or eyes.

- Do not heat unopened food containers. Pressure could build up and the container could burst, causing an injury.
- Keep the oven vents unobstructed.
- Keep the oven free from grease buildup.
- Place the oven rack in the desired position while the oven is cool. If racks must be handled when hot, do not let pot holder contact the heating elements.
- When using cooking or roasting bags in the oven, follow the manufacturer's directions.
- Pulling out the rack to the stop-lock is a convenience in lifting heavy foods. It is also a precaution against burns from touching hot surfaces of the door or oven walls.
- Do not use the oven to dry newspapers. If overheated, they can catch on fire.
- Do not use the oven for a storage area. Items stored in an oven can ignite.
- Do not leave paper products, cooking utensils or food in the oven when not in use.

**⚠️ WARNING: NEVER** cover any slots, holes or passages in the oven bottom or cover an entire rack with materials such as aluminum foil. Doing so blocks air flow through the oven and may cause carbon monoxide poisoning. Aluminum foil linings may also trap heat, causing a fire hazard.

- Do not use aluminum foil to line oven bottoms, except as suggested in this manual. Improper installation of aluminum foil may result in a risk of electric shock or fire.
- Make sure the broiler pan is in place correctly to reduce the possibility of grease fires.
- If you should have a grease fire in the broiler pan, press the **CLEAR/OFF** pad and keep the oven door closed to contain fire until it burns out.



## SELF-CLEANING OVEN

Do not use oven cleaners. No commercial oven cleaner or oven liner protective coating of any kind should be used in or around any part of the oven. Residue from oven cleaners will damage the inside of the oven when the self-clean cycle is used.

- Do not clean the door gasket. The door gasket is essential for a good seal. Care should be taken not to rub, damage or move the gasket.
- Before self-cleaning the oven, remove the racks, broiler pan, grid and other cookware.
- Be sure to wipe up excess spillage before starting the self-cleaning operation.
- If the self-cleaning mode malfunctions, turn the oven off and disconnect the power supply. Have it serviced by a qualified technician.
- Clean only parts listed in this Owner's Manual.



READ AND FOLLOW THIS SAFETY INFORMATION CAREFULLY.  
**SAVE THESE INSTRUCTIONS**

## Using the gas surface burners.

Throughout this manual, features and appearance may vary from your model.

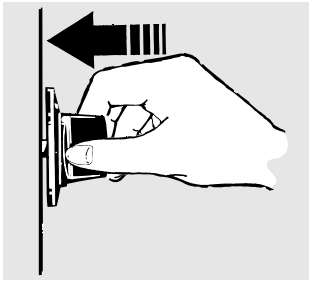

Push the control knob in and turn it to the **LITE** position.

### How to Light a Gas Surface Burner

Push the control knob in and turn it to the **LITE** position.

You will hear a little **clicking** noise—the sound of the electric spark igniting the burner.

After the flame lights, turn the knob to adjust the flame size. If the knob stays at **LITE**, it will continue to click.

When one burner is turned to **LITE**, all the burners spark. Do not attempt to disassemble or clean around any burner while another burner is on. An electric shock may result, which could cause you to knock over hot cookware.

### Sealed Gas Burners

The smaller burner (right rear position) will give the best simmer results for delicate foods, such as sauces or foods which need to cook over low heat for a long time. It can be turned down to a very low setting.

The largest burners are higher powered than the others and will bring liquids to a boil quicker.

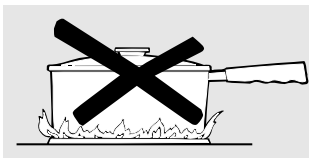

### How to Select Flame Size

For safe handling of cookware, never let the flames extend up the sides of the cookware.

Watch the flame, not the knob, as you reduce heat. The flame size on a gas burner should match the cookware you are using.

Any flame larger than the bottom of the cookware is wasted and only serves to heat the handle.

### In Case of Power Failure

In case of a power failure, you can light the gas surface burners on your range with a match. Hold a lit match to the burner, then push in and turn the control knob to the **LITE** position. Use extreme caution when lighting burners this way.

Surface burners in use when an electrical power failure occurs will continue to operate normally.

### Before Lighting a Gas Burner

- Make sure all grates on the range are in place before using any burner.

### After Lighting a Gas Burner

- Do not operate the burner for an extended period of time without cookware on the grate. The finish on the grate may chip without cookware to absorb the heat.
- Be sure the burners and grates are cool before you place your hand, a pot holder, cleaning cloths or other materials on them.



### Top-of-Range Cookware

**Aluminum:** Medium-weight cookware is recommended because it heats quickly and evenly. Most foods brown evenly in an aluminum skillet. Use saucepans with tight-fitting lids when cooking with minimum amounts of water.

**Cast-Iron:** If heated slowly, most skillets will give satisfactory results.

**Enamelware:** Under some conditions, the enamel of some cookware may melt. Follow cookware manufacturer's recommendations for cooking methods.

**Glass:** There are two types of glass cookware—those for oven use only and those for top-of-range cooking (saucepans, coffee and teapots). Glass conducts heat very slowly.

**Heatproof Glass Ceramic:** Can be used for either surface or oven cooking. It conducts heat very slowly and cools very slowly. Check cookware manufacturer's directions to be sure it can be used on gas ranges.

**Stainless Steel:** This metal alone has poor heating properties and is usually combined with copper, aluminum or other metals for improved heat distribution. Combination metal skillets usually work satisfactorily if they are used with medium heat as the manufacturer recommends.

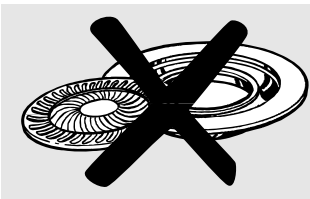

### Stove Top Grills

Do not use stove top grills on your sealed gas burners. If you use the stove top grill on the sealed gas burner, it will cause incomplete combustion and can result in exposure to carbon monoxide levels above allowable current standards.

*This can be hazardous to your health.*

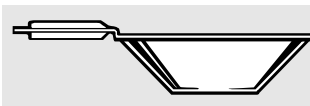

Use a flat-bottomed wok.

### Wok This Way

We recommend that you use a 14-inch or smaller flat-bottomed wok. They are available at your local retail store. Make sure the wok bottom sits flat on the grate.

Only a flat-bottomed wok should be used.

Do not use a round-bottomed wok on a support ring. Placing the ring over the burner or grate may cause the burner to work improperly, resulting in carbon monoxide levels above allowable standards. This could be dangerous to your health.

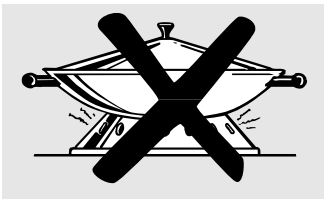

## Using the oven controls.

Throughout this manual, features and appearance may vary from your model.

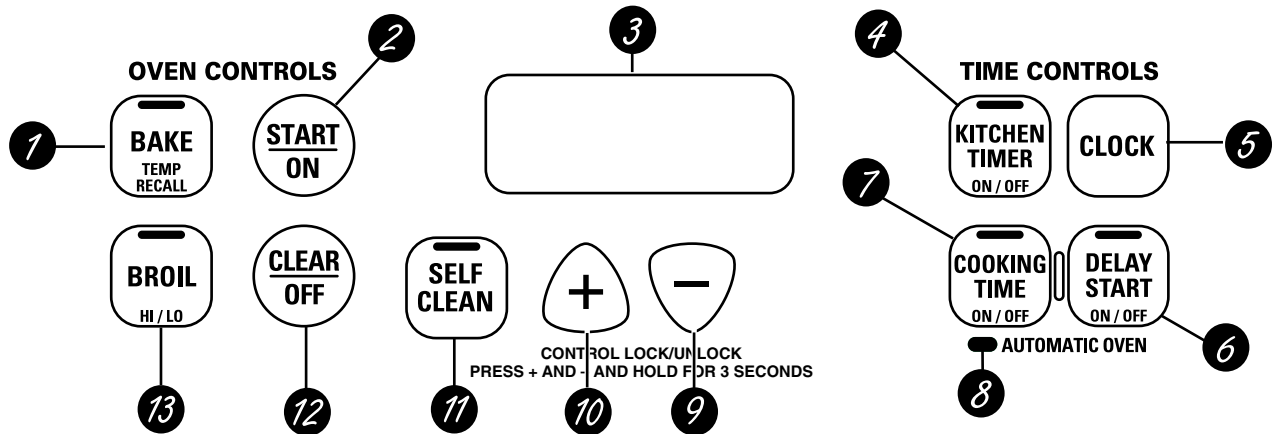

### Oven Control, Clock and Timer Features and Settings

- 1** **BAKE/TEMP RECALL Pad**  
Touch this pad to select the bake function.

#### **BAKE Light**

Flashes while in edit mode—you can change the oven temperature at this point. Glows when the oven is in bake mode.

- 2** **START/ON Pad**  
Must be touched to start any cooking or cleaning function.

- 3** **Display**  
Shows the time of day, oven temperature, whether the oven is in the bake, broil or self-cleaning mode and the times set for the timer or automatic oven operations. The display will show "PrE" while preheating. When the oven reaches the selected temperature, the oven control will beep and the display will show the oven temperature.

#### **Function Error Code**

If "F- and a number or letter" flash in the display and the oven control signals, this indicates a function error code.

If the function error code appears during the self-cleaning cycle, check the oven door latch. The latch handle may have been moved, even if only slightly, from the latched position. Make sure the latch is moved to the right as far as it will go.

**Touch the CLEAR/OFF pad.** Allow the oven to cool for one hour. Put the oven back into operation. If the function error code repeats, disconnect the power to the range and call for service.

- 4** **KITCHEN TIMER ON/OFF Pad**  
Touch this pad to select the timer feature. Then press + and – pads to adjust time.

#### **TIMER Light**

Flashes while in edit mode—you can change the set time at this point. Glows when the timer has been activated. Flashes again when the time has run out until the control is reset.

- 5** **CLOCK Pad**  
To set clock, touch this pad twice and then touch the + and – pads. The time of day will flash in display when oven is first turned on.

- 6** **DELAY START Pad**  
Use along with the **COOKING TIME** or **SELF CLEAN** pads to set the oven to start and stop automatically at a time you set.

#### **DELAY START Time Light**

Flashes while in edit mode—you can change the delay start set time at this point. Glows when the function has been activated.

- 7** **COOKING TIME Pad**  
Touch this pad and then touch the + or – pads to set the amount of time you want your food to cook. The oven will shut off when the cooking time has run out.

#### **COOKING TIME Light**

Flashes while in edit mode—you can change set time at this point. Glows when function has been activated. Flashes again when the time has run out until the control is reset.

- 8** **AUTOMATIC OVEN Light**  
This lights anytime the oven has been programmed using the **COOKING TIME** or **DELAY START** functions.



## Oven Control, Clock and Timer Features and Settings

### 9 – Pad

Short taps to this pad will decrease the time or temperature by small amounts. Touch and hold the pad to decrease the time or temperature by larger amounts.

### 10 + Pad

Short taps to this pad will increase the time or temperature by small amounts. Touch and hold the pad to increase the time or temperature by larger amounts.

### 11 SELF CLEAN Pad

Touch this pad to select the self-cleaning function. See the *Using the self-cleaning oven* section.

#### CLEAN Light

Flashes while in edit mode—you can change the length of time for the self-clean cycle at this point. Glows when the oven is in the self-clean cycle. After the self-clean cycle, the light will turn off. Unlatch the door.

### 12 CLEAR/OFF Pad

Touch this pad to cancel **ALL** oven operations except the clock and timer.

### 13 BROIL HI/LO Pad

Touch this pad to select the broil function.

#### BROIL Light

Flashes while in edit mode—you can switch from **HI** to **LO BROIL** at this point. Glows when the oven is in broil mode.

#### Indicator Lights (on some pads)

**EDIT** mode lasts several seconds after the last pad press. **DELAY START ON/OFF** and **COOKING TIME ON/OFF** will be the only pads lit if either of these options is selected. (Example: **DELAY START** is selected with **BAKE**—the **DELAY START** pad will remain lit until the clock reaches the programmed time, at which point it will turn off and the **BAKE/TEMP RECALL** pad light will light up).

### Control Lockout

Your control will allow you to lock out the touch pads so they cannot be activated when touched.

#### To lock/unlock the controls:

- 1 Touch the **+** and **-** pads at the same time for 3 seconds, until the display shows **LOC ON**.
- 2 To unlock the control, touch the **+** and **-** pads at the same time for 3 seconds, until the display shows **LOC OFF**.

When this feature is on and the touch pads are touched, the control will beep and the display will show **LOC ON**.

- The control lockout mode affects all touch pads. No touch pads will work when this feature is activated.
- The adjustment will be retained in memory after a power failure.

### Power Outage

**CAUTION:** Do not make any attempt to operate the electric ignition oven during an electrical power failure.

The oven or broiler cannot be lit during a power failure. Gas will not flow unless the glow bar is hot.

If the oven is in use when a power failure occurs, the oven burner shuts off and cannot be re-lit until power is restored. This is because the flow of gas is automatically stopped and will not resume when power is restored until the glow bar has reached operating temperature.

If a flashing time is in the display, electric power has been restored. Reset the clock.

If your oven was set for a timed oven operation and a power outage occurred, the clock and all programmed functions must be reset.

To reset the clock, touch the **CLOCK** pad. Enter the correct time of day by touching the **+** or **-** pads. Touch the **START/ON** pad.

## Using the oven.

To avoid possible burns, place the racks in the desired position before you turn the oven on.

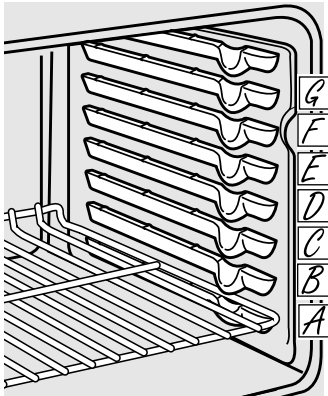

The oven has 7 rack positions.

### Before you begin...

The racks have stops, so that when placed correctly on the supports, they will stop before coming completely out, and will not tilt.

When placing and removing cookware, pull the rack out until it stops.

The bake burner is under the oven floor. Do not place foods on the oven bottom for cooking.

**To remove a rack**, pull it toward you, tilt the front end up and pull it out.

**To replace**, place the end of the rack (stop-locks) on the support, tilt up the front and push the rack in.

**CAUTION:** When you are using the rack in the lowest position (A), you will need to use caution when pulling the rack out. We recommend that you pull the rack out several inches and then, using two pot holders, pull the rack out by holding the sides of it. The rack is low and you could be burned if you place your hand in the middle of the rack and pull all the way out. Be very careful not to burn your hand on the door when using the rack in the lowest position (A).

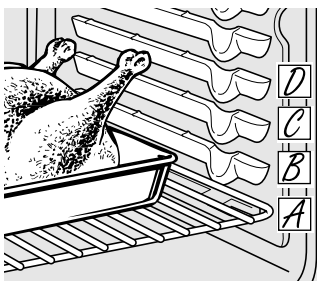

### How to Set the Oven for Baking or Roasting

- 1 Touch the **BAKE** pad.
- 2 Touch the **+** or **-** pads until the desired temperature is displayed.
- 3 Touch the **START/ON** pad.

The oven will start automatically. The display will show "PrE" while preheating. When the oven reaches the selected temperature, the oven control will beep several times and the display will show the oven temperature.

To change the oven temperature during BAKE cycle, touch the **BAKE** pad and then the **+** or **-** pads to get the new temperature.

- 4 Check food for doneness at minimum time on recipe. Cook longer if necessary.
- 5 Touch the **CLEAR/OFF** pad when baking is finished and then remove the food from the oven.

**NOTE:** A cooling fan will automatically turn on and off to cool internal parts. This is normal, and the fan may continue to run even after the oven is turned off.

Type of Food	Rack Position
Frozen pies (on cookie sheet)	C or D
Angel food cake	A
Bundt or pound cakes	B or C
Biscuits, muffins, brownies, cookies, cupcakes, layer cakes, pies	C or D
Casseroles	C or D
Turkey	A

If baking four cake layers at the same time, place two layers on rack B and two layers on rack D. Stagger pans on the rack so one is not directly above the other.

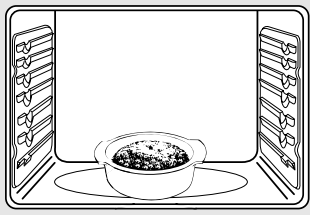

Do not place foods directly on the oven floor.

### Preheating and Pan Placement

Preheat the oven if the recipe calls for it. Preheating is necessary for good results when baking cakes, cookies, pastry and breads.

*To preheat, set the oven at the correct temperature. The control will beep when the oven is preheated and the display will show your set temperature. The preheat time will vary depending on the temperature setting.*

Baking results will be better if baking pans are centered in the oven as much as possible. If baking with more than one pan, place the pans so each has at least 1" to 1½" of air space around it.

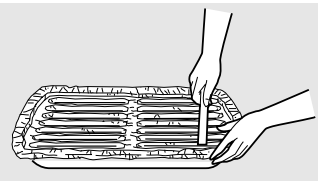

Cut slits in the foil just like the grid.

### Aluminum Foil

You can use aluminum foil to line the broiler pan and broiler grid. However, you must mold the foil tightly to the grid and cut slits in it just like the grid.

Without the slits, the foil will prevent fat and meat juices from draining into the broiler pan. The juices could become hot enough to catch on fire. If you do not cut the slits, you are essentially frying, not broiling.

*Do not use aluminum foil on the bottom of the oven.*

Never entirely cover a rack with aluminum foil. This will disturb the heat circulation and result in poor baking.

A smaller sheet of foil may be used to catch a spillover by placing it on a lower rack several inches below the food.

### Oven Moisture

As your oven heats up, the temperature change of the air in the oven may cause water droplets to form on the door glass. These droplets are harmless and will evaporate as the oven continues to heat up.

### Oven Vent

Your oven is vented through the rear vent located through the cooktop under the vent grille. Do not block this vent when cooking in the oven—it is important that the flow of hot air from the oven and fresh air to the oven burner be uninterrupted. **Avoid touching the vent openings or nearby surfaces during oven or broiler operation—they may become hot.**

- Handles of pots and pans on the cooktop may become hot if left too close to the vent.
- Do not leave plastic items on the cooktop—they may melt if left too close to the vent.
- Do not leave any items on the cooktop. The hot air from the vent may ignite flammable items and will increase pressure in closed containers, which may cause them to burst.
- Metal items will become very hot if they are left on the cooktop, and could cause burns.

## Using the oven.

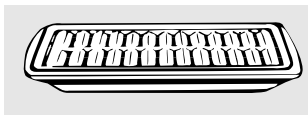

Always use the broiler pan and grid that came with your oven. It is designed to minimize smoking and spattering by trapping juices in the shielded lower part of the pan.

### How to Set the Oven for Broiling

**IMPORTANT:** To avoid possible burns, place the racks in the desired position before you turn the oven on.

- 1 Place the meat or fish on the broiler grid in the broiler pan.
- 2 Follow suggested rack positions in the *Broiling Guide*.
- 3 The oven door **must** be closed during broiling.
- 4 Touch the **BROIL HI/LO** pad once for **HI Broil**.

To change to **LO Broil**, touch the **BROIL HI/LO** pad again.

Use **LO Broil** to cook foods such as poultry or thick cuts of meat thoroughly without over-browning them.

- 5 Touch the **START/ON** pad.
- 6 When broiling is finished, touch the **CLEAR/OFF** pad.

Serve the food immediately, and leave the pan outside the oven to cool during the meal for easiest cleaning.

### Broiling Guide

The size, weight, thickness, starting temperature and your preference of doneness will affect broiling times. This guide is based on meats at refrigerator temperature.

† The U.S. Department of Agriculture says "Rare beef is popular, but you should know that cooking it to only 140°F means some food poisoning organisms may survive." (Source: *Safe Food Book, Your Kitchen Guide*. USDA Rev. June 1985.)

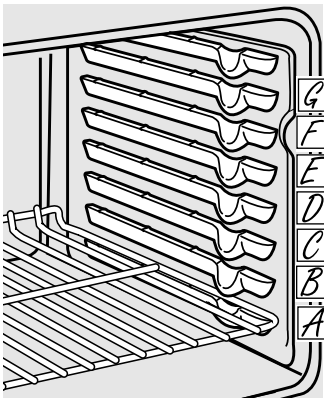

The oven has 7 rack positions.

Food	Quantity and/or Thickness	Rack Position	First Side Time (min.)	Second Side Time (min.)	Comments
<b>Ground Beef</b>	1/2" to 3/4" thick	D	13	8	Space evenly.
<b>Beef Steaks</b>					
Rare†	3/4" to 1" thick	F	6	4	Steaks less than 3/4" thick are difficult to cook rare. Slash fat.
Medium	1 to 1 1/2 lbs.	E	8	6	
Well Done		E	10	8	
Rare†	1 1/2" thick	E	15	10	
Medium	2 to 2 1/2 lbs.	E	15	15	
Well Done		D	20	20	
<b>Chicken</b>					
	1 whole cut up to 2 1/2 lbs., split lengthwise	C	25	25	Brush each side with melted butter. Broil skin-side-down first.
	Breast	C	25	15	
<b>Bakery Product</b>					
Bread (toast)	2 to 4 slices	F	3	1	Space evenly. Place English muffins cut-side-up and brush with butter if desired.
English Muffin	2 (split)	F	3-4		
<b>Lobster Tails</b>	2-4	C	18-20	Do not turn over.	Cut through back of shell. Spread open. Brush with melted butter before broiling and after half of broiling time.
<b>Fish Fillets</b>	1 lb. (1/4" to 1/2" thick)	E	6	6	Handle and turn very carefully. Brush with lemon butter before and during cooking, if desired.
<b>Salmon</b>					
Steaks	2 (1" thick)	E	10	5	Turn carefully. Do not turn skin-side-down.
Fillets	2 (1/2" to 3/4" thick)	E	15		
<b>Ham Slices</b>					
(precooked)	1/2" thick	D	8	5	
	1" thick	D	8	8	
<b>Pork Chops</b>					
Well Done	2 (1/2" thick)	D	10	10	Slash fat.
	2 (1" thick) about 1 lb.	D	15	5	

# Using the clock and timer.

Not all features are on all models.

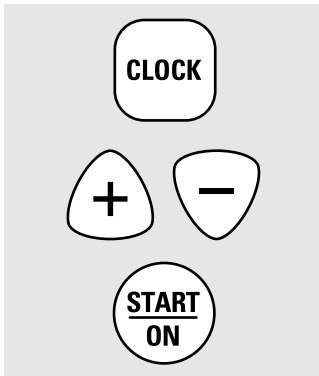

Make sure the clock is set to the correct time of day.

## To Set the Clock

The clock must be set to the correct time of day for the automatic oven timing functions to work properly. The time of day cannot be changed during a delayed cooking or a delayed self-cleaning cycle.

- 1 Touch the **CLOCK** pad twice.
- 2 Touch the **+** or **-** pads.

If the **+** or **-** pads are not touched within one minute after you touch the **CLOCK** pad, the display reverts to the original

setting. If this happens, touch the **CLOCK** pad twice and reenter the time of day.

- 3 Touch the **START/ON** pad until the time of day shows in the display. This enters the time and starts the clock.

To check the time of day when the display is showing other information, simply touch the **CLOCK** pad. The time of day shows until another pad is touched.

## To Turn Off the Clock Display

If you have several clocks in your kitchen, you may wish to turn off the time of day clock display on your range.

- 1 Touch the **CLOCK** pad once to turn off the time of day display. Although you will not be able to see it, the

clock maintains the correct time of day.

- 2 Touch the **CLOCK** pad twice to recall the clock display.

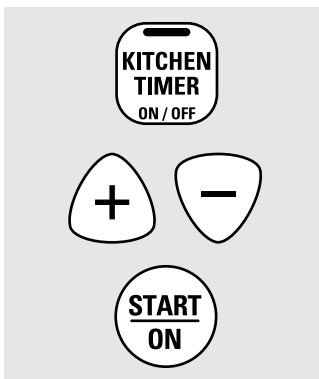

The **CLEAR/OFF** pad does not affect the timer.

## To Set the Timer

The timer does not control oven operations. The maximum setting on the timer is 9 hours and 59 minutes.

- 1 Touch the **KITCHEN TIMER ON/OFF** pad.
- 2 Touch the **+** or **-** pads until the amount of time you want shows in the display. The maximum time that can be entered in minutes is 59. Times more than 59 minutes should be changed to hours and minutes.

If you make a mistake, touch the **KITCHEN TIMER ON/OFF** pad and begin again.

- 3 Touch the **START/ON** pad. The time will start counting down, although the display does not change until one minute has passed.
- 4 When the timer reaches **:00**, the control will beep 3 times followed by one beep every 6 seconds until the **KITCHEN TIMER ON/OFF** pad is touched.

## To Reset the Timer

If the display is still showing the time remaining, you may change it by touching the **KITCHEN TIMER ON/OFF** pad, then touching the **+** or **-** pads until the time you want appears in the display.

If the remaining time is not in the display (clock, delay start set time or cooking time are in the display), recall the remaining time by touching the **KITCHEN TIMER ON/OFF** pad and then touching the **+** or **-** pads to enter the new time you want.

## To Cancel the Timer

Touch the **KITCHEN TIMER ON/OFF** pad twice.

## Using the timed baking and roasting features.

Do not lock the oven door with the latch during timed cooking. The latch is used for self-cleaning only.

**NOTE:** Foods that spoil easily—such as milk, eggs, fish, stuffings, poultry and pork—should not be allowed to sit for more than 1 hour before or after cooking. Room temperature promotes the growth of harmful bacteria. Be sure that the oven light is off because heat from the bulb will speed harmful bacteria growth.

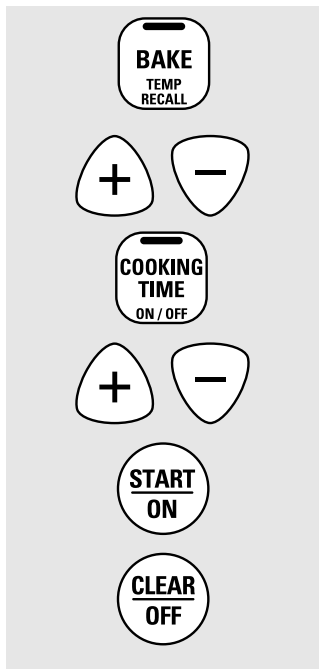

### How to Set an Immediate Start and Automatic Stop

The oven will turn on immediately and cook for a selected length of time. At the end of the cooking time, the oven will turn off automatically.

- 1 Touch the **BAKE** pad.
- 2 Touch the **+** or **-** pads to set the oven temperature.
- 3 Touch the **COOKING TIME** pad.

**NOTE:** If your recipe requires preheating, you may need to add additional time to the length of the cooking time.

- 4 Touch the **+** or **-** pads to set the baking time.

The cooking time that you entered will be displayed. (If you select Cooking Time first and then adjust the Bake Temperature, the oven temperature will be displayed instead).

- 5 Touch the **START/ON** pad.

The display shows either the oven temperature that you set or the cooking time countdown. (The display starts with "PrE" if showing the oven temperature.)

The oven will continue to cook for the programmed amount of time, then turn off automatically.

- 6 Touch the **CLEAR/OFF** pad to clear the display if necessary.

Remove the food from the oven. Remember, even though the oven shuts off automatically, foods continue cooking after controls are off.

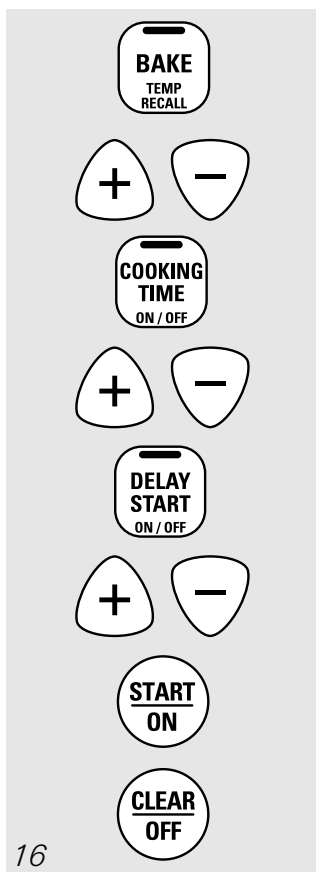

### How to Set a Delayed Start and Automatic Stop

The oven will turn on at the time of day you set, cook for a specific length of time and then turn off automatically.

Make sure the clock shows the correct time of day.

- 1 Touch the **BAKE** pad.
- 2 Touch the **+** or **-** pads to set the oven temperature.
- 3 Touch the **COOKING TIME** pad.
- 4 Touch the **+** or **-** pads to set the desired length of cooking time.
- 5 Touch the **DELAY START** pad.
- 6 Touch the **+** or **-** pads to set the time of day you want the oven to turn on and start cooking.
- 7 Touch the **START/ON** pad.

**NOTE:** An attention tone will sound if you are using timed baking and do not touch the **START/ON** pad.

**NOTE:** If you would like to check the times you have set, touch the **DELAY START** pad to check the delay start set time you have set or touch the **COOKING TIME** pad to check the length of cooking time you have set.

When the oven turns on at the time of day you have set, the display will show "PrE" until it reaches the selected temperature, then it will display the oven temperature.

At the end of cooking time, the oven will turn off and the end-of-cycle tone will sound.

- 8 Touch the **CLEAR/OFF** pad to clear the display if necessary.

Remove the food from the oven. Remember, even though the oven shuts off automatically, foods continue cooking after controls are off.



## Special features of your oven control.

www.GEAppliances.com

Your new touch pad control has additional features that you may choose to use. The following are the features and how you may activate them.

The special feature modes can only be activated while the display is showing the time of day. They remain in the control's memory until the steps are repeated.

When the display shows your choice, touch the **START/ON** pad. The special features will remain in memory after a power failure.

**NOTE:** The Sabbath feature and the Thermostat Adjustment feature are also Special Features, but they are addressed separately in the following sections.

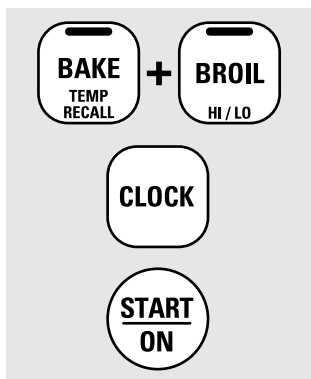

### 12 Hour Shut-Off

With this feature, should you forget and leave the oven on, the control will automatically turn off the oven after 12 hours during baking functions or after 3 hours during a broil function.

If you wish to turn **OFF** this feature, follow the steps below.

- 1 Touch the **BAKE** and **BROIL HI/LO** pads at the same time for 3 seconds until the display shows **SF**.
- 2 Touch the **CLOCK** pad. The display will show **ON** (12 hour shut-off). Touch the **CLOCK** pad repeatedly until the display shows **OFF** (no shut-off).
- 3 Touch the **START/ON** pad to activate the no shut-off and leave the control set in this special features mode.

## Using the Sabbath Feature.

(Designed for use on the Jewish Sabbath and Holidays)

The Sabbath feature can be used for baking/roasting only. It cannot be used for broiling, self-cleaning or Delay Start cooking.

**NOTE:** The oven light comes on automatically (on some models) when the door is opened and goes off when the door is closed. The bulb may be removed. See the Oven Light Replacement section. On models with a light switch on the control panel, the oven light may be turned on and left on.

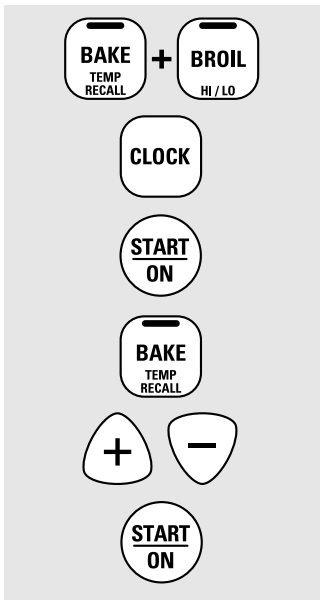

When the display shows  $\supset \subset$  the oven is set in Sabbath. When the display shows  $\supset \subset$  the oven is baking/roasting.

### How to Set for Regular Baking/Roasting

**NOTE:** To understand how the oven control works, practice using regular baking (non-Sabbath) before entering Sabbath mode.

Make sure the clock shows the correct time of day and the oven is off.

- 1 Touch and hold **both** the **BAKE** and **BROIL HI/LO** pads, **at the same time**, until the display shows **SF**.
- 2 Tap the **CLOCK** pad until **SAb** appears in the display.
- 3 Touch the **START/ON** pad and  $\supset \subset$  will appear in the display.
- 4 Touch the **BAKE** pad. No signal will be given.
- 5 The preset starting temperature will automatically be set to 350°. Tap the **+** or **-** pads to increase or decrease the temperature in 5° increments. The temperature can be set between 170° and 550°. No signal or temperature will be given.

- 6 Touch the **START/ON** pad.
- 7 After a random delay period of approximately 30 seconds to 1 minute,  $\supset \subset$  will appear in the display indicating that the oven is baking/roasting. If  $\supset \subset$  doesn't appear in the display, start again at Step 4.

To adjust the oven temperature, touch the **BAKE** pad and tap the **+** or **-** pads to increase or decrease the temperature in 5° increments. Touch the **START/ON** pad.

**NOTE:** The **CLEAR/OFF** and **COOKING TIME** pads are active during the Sabbath feature.

To exit Sabbath feature see next page.

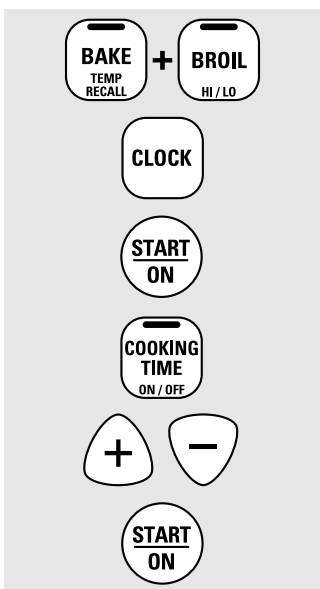

When the display shows  $\supset \subset$  the oven is set in Sabbath. When the display shows  $\supset \subset$  the oven is baking/roasting.

### How to Set for Timed Baking/Roasting—Immediate Start and Automatic Stop

**NOTE:** To understand how the oven control works, practice using regular (non-Sabbath) Immediate Start and Automatic Stop before entering the Sabbath mode.

Make sure the clock shows the correct time of day and the oven is off.

- 1 Touch and hold **both** the **BAKE** and **BROIL HI/LO** pads, **at the same time**, until the display shows **SF**.
- 2 Tap the **CLOCK** pad until **SAb** appears in the display.
- 3 Touch the **START/ON** pad and  $\supset \subset$  will appear in the display.
- 4 Touch the **COOKING TIME** pad.
- 5 Touch the **+** or **-** pads to set the desired length of cooking time between 1 minute and 9 hours and 59 minutes. The cooking time that you entered will be displayed.
- 6 Touch the **START/ON** pad.
- 7 Touch the **BAKE** pad. No signal will be given.
- 8 The preset starting temperature will automatically be set to 350°. Tap the **+** or **-** pads to increase or decrease the temperature in 5° increments. The temperature can be set between 170° and 550°. No signal or temperature will be given.
- 9 Touch the **START/ON** pad.
- 10 After a random delay period of approximately 30 seconds to 1 minute,  $\supset \subset$  will appear in the display indicating that the oven is baking/roasting. If  $\supset \subset$  doesn't appear in the display, start again at Step 7.

To adjust the oven temperature, touch the **BAKE** pad and tap the **+** or **-** pads to increase or decrease the temperature in 5° increments. Touch the **START/ON** pad.

When cooking is finished, the display will change from  $\supset \subset$  to  $\supset$  indicating that the oven has turned **OFF** but is still set in Sabbath. Remove the cooked food.

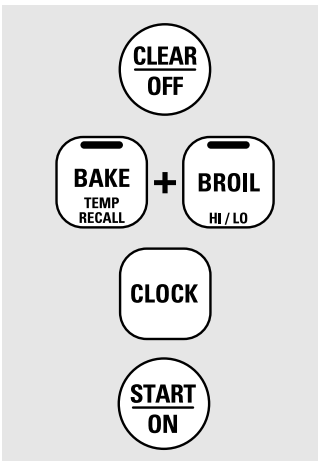

### How to Exit the Sabbath Feature

- 1 Touch the **CLEAR/OFF** pad.
- 2 If the oven is cooking, wait for a random delay period of approximately 30 seconds to 1 minute, until only  $\triangleright$  is in the display.
- 3 Touch and hold **both** the **BAKE** and **BROIL HI/LO** pads, **at the same time**, until the display shows **SF**.
- 4 Tap the **CLOCK** pad until **ON** or **OFF** appears in the display. **ON** indicates that the oven will automatically turn off after 12 hours. **OFF** indicates that the oven will not automatically turn off. See the *Special Features* section for an explanation of the *12 Hour Shut-Off* feature.
- 5 Touch the **START/ON** pad.

**NOTE:** If a power outage occurred while the oven was in Sabbath, the oven will automatically turn off and stay off even when the power returns. The oven control must be reset.

## Adjust the oven thermostat—Do it yourself!

You may find that your new oven cooks differently than the one it replaced. Use your new oven for a few weeks to become more familiar with it. If you still think your new oven is too hot or too cold, you can adjust the thermostat yourself.

Do not use thermometers, such as those found in grocery stores, to check the temperature setting of your oven. These thermometers may vary 20–40 degrees.

**NOTE:** This adjustment will not affect the broiling or the self-cleaning temperatures. The adjustment will be retained in memory after a power failure.

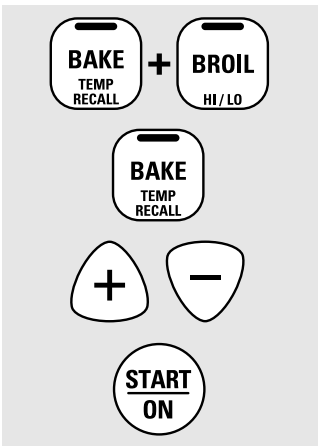

### To Adjust the Thermostat

- 1 Touch the **BAKE** and **BROIL HI/LO** pads at the same time for 2 seconds until the display shows **SF**.
- 2 Touch the **BAKE** pad. A two-digit number shows in the display.
- 3 The oven temperature can be adjusted up to (+) 35°F hotter or (–) 35°F cooler. Touch the **+** pad to increase the temperature in 1-degree increments.

Touch the **–** pad to decrease the temperature in 1-degree increments.

**NOTE:** This adjustment will not affect the broiling or self-cleaning temperatures. It will be retained in memory after a power failure.

## The type of margarine will affect baking performance!

Most recipes for baking have been developed using high-fat products such as butter or margarine (80% fat). If you decrease the fat, the recipe may not give the same results as with a higher-fat product.

Recipe failure can result if cakes, pies, pastries, cookies or candies are made with low-fat spreads. The lower the fat content of a spread product, the more noticeable these differences become.

Federal standards require products labeled “margarine” to contain at least 80% fat by weight. Low-fat spreads, on the other hand, contain less fat and more water. The high moisture content of these spreads affects the texture and flavor of baked goods. For best results with your old favorite recipes, use margarine, butter or stick spreads containing at least 70% vegetable oil.

## Using the self-cleaning oven.

Never force the latch handle. Forcing the handle will damage the door lock mechanism.

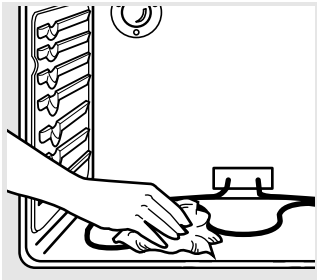

Wipe up heavy soil on the oven bottom.

### Before a Clean Cycle

We recommend venting your kitchen with an open window or using a ventilation fan or hood during the first self-clean cycle.

Remove the racks, broiler pan, broiler grid, all cookware and any aluminum foil from the oven.

**NOTE:** Take the racks out of the oven before you begin the self-clean cycle or they may discolor.

Soil on the front frame of the range and outside the gasket on the door will need to be cleaned by hand. Clean these areas with hot water, soap-filled steel wool pads or cleansers such as Soft Scrub®. Rinse well with clean water and dry.

Do not clean the gasket. The fiberglass material of the oven door gasket cannot withstand abrasion. It is essential for the gasket to remain intact. If you notice it becoming worn or frayed, replace it.

Wipe up any heavy spillovers on the oven bottom.

Make sure the oven light bulb cover is in place and the oven light is off.

**IMPORTANT:** The health of some birds is extremely sensitive to the fumes given off during the self-cleaning cycle of any range. Move birds to another well-ventilated room.

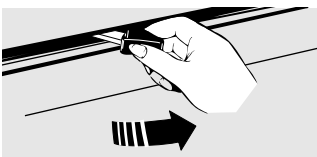

### How to Set the Oven for Cleaning

Follow the directions in the *Before a Clean Cycle* section.

- 1 Latch the door.
- 2 Touch the **SELF CLEAN** pad.
- 3 Touch the **+** or **-** pads until the desired Clean Time is displayed.

The Clean Time is normally 4 hours. You can change the Clean Time to any time between 3 and 5 hours, depending on the amount of soil in your oven.

- 4 Touch the **START/ON** pad.

The self-clean cycle will automatically begin after **CLEAN** is displayed and the time countdown appears in the display.

While the oven is self-cleaning, you can touch the **CLOCK** pad to display the time of day. To return to the clean countdown, touch the **SELF CLEAN** pad.

The oven shuts off automatically when the clean cycle is complete, and 0:00 will flash in the display.

- 5 Slide the latch handle to the left as far as it will go and open the door.

It will not be possible to unlatch the oven door until the temperature drops below the lock temperature and the clean light goes off.

When the clean light is off, unlatch the door.

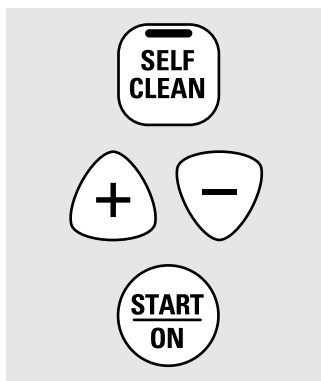

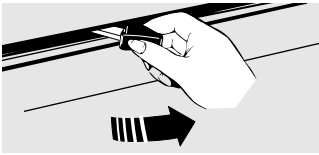

### How to Delay the Start of Cleaning

Make sure the clock shows the correct time of day.

- 1 Latch the door.
- 2 Touch the **SELF CLEAN** pad.
- 3 Using the **+** or **-** pads, enter the desired clean time.

*The Clean Time is normally 4 hours. You can change the Clean Time to any time between 3 and 5 hours, depending on the amount of soil in your oven.*

- 4 Touch the **DELAY START** pad. The earliest delay start time you can set will appear in the display.
- 5 Using the **+** or **-** pads, enter the time of day you want the clean cycle to start.
- 6 Touch the **START/ON** pad.

The display will show the delay start set time. It will not be possible to unlatch the oven door until the temperature drops below the lock temperature and the clean light goes off.

When the clean light is off, unlatch the door.

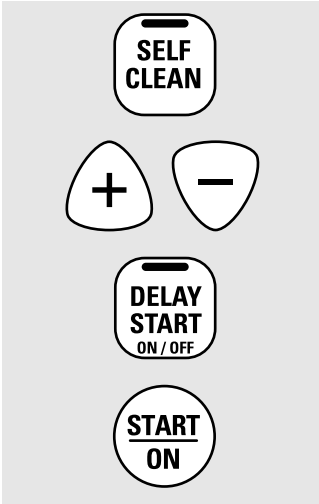

### To Stop a Clean Cycle

Touch the **CLEAR/OFF** pad.

Wait until the oven has cooled below the locking temperature to unlatch the door. You will not be able to open the door right away unless the oven has cooled below the locking temperature.

### After a Clean Cycle

You may notice some white ash in the oven. Wipe it up with a damp cloth after the oven cools.

*If white spots remain, remove them with a soap-filled scouring pad and rinse thoroughly with a vinegar and water mixture.*

These deposits are usually a salt residue that cannot be removed by the clean cycle.

If the oven is not clean after one clean cycle, repeat the cycle.

- You cannot set the oven for cooking until the oven is cool enough for the door to be unlatched.
- While the oven is self-cleaning, you can touch the **CLOCK** pad to display the time of day. To return to the clean countdown, touch the **COOKING TIME** pad.
- Apply a small amount of vegetable oil to a paper towel and wipe the edges of the oven racks with the paper towel. Do not spray with Pam® or other lubricant sprays.

## Care and cleaning of the range.

Be sure all controls are off and all surfaces are cool before cleaning any part of the range.

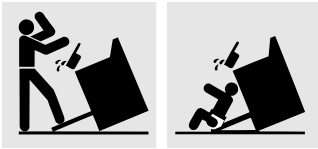

If your range is removed for cleaning, servicing or any reason, be sure the anti-tip device is reengaged properly when the range is replaced. Failure to take this precaution could result in tipping of the range and cause injury.

### How to Remove Packaging Tape

To assure no damage is done to the finish of the product, the safest way to remove the adhesive left from packaging tape and cooktop labels on new appliances is an application of a household liquid dishwashing detergent, mineral oil or cooking oil.

Apply with a soft cloth and allow to soak. Wipe dry and then apply an appliance polish to thoroughly clean and protect the surface.

**NOTE:** The adhesive must be removed from all parts. It cannot be removed if it is baked on.

### Control Knobs

The control knobs may be removed for easier cleaning.

Before removing the knobs for cleaning, please note that the knobs are in the **OFF** position. When replacing the knobs, check the **OFF** position to insure proper placement.

Wash the knobs in soap and water or a vinegar and hot water solution but do not soak.

The knobs can also be cleaned in a dishwasher.

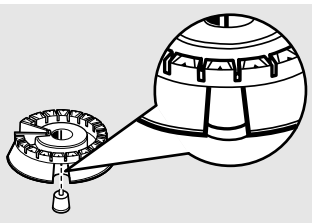

Make sure the slot in the burner head is positioned over electrode.

**CAUTION:** DO NOT OPERATE THE BURNER WITHOUT ALL BURNER PARTS IN PLACE.

### Burner Assembly

The burner assemblies should be washed regularly and, of course, after spills.

Turn all controls off before removing burner parts.

The burner grates, burner heads and burner caps can be removed for easy cleaning.

The electrode of the spark igniter is exposed beyond the surface of the burner base. When cleaning the cooktop, be careful not to snag the electrode of the spark igniter with your cleaning cloth. Damage to the igniter could occur. **To avoid snagging a cloth on the spark igniter, leave the burner heads in place when cleaning the cooktop.**

Be careful not to push in any cooktop controls while cleaning the cooktop. A slight electrical shock might result which could cause you to knock over hot cookware.

Wash burner parts with an all-purpose non-abrasive cleaner and warm water. Soak stubborn soil. Dry them with a cloth—do not reassemble while wet.

### To reassemble the surface burners:

**1** Place burner heads over the electrodes on the cooktop, in the correct locations according to their size.

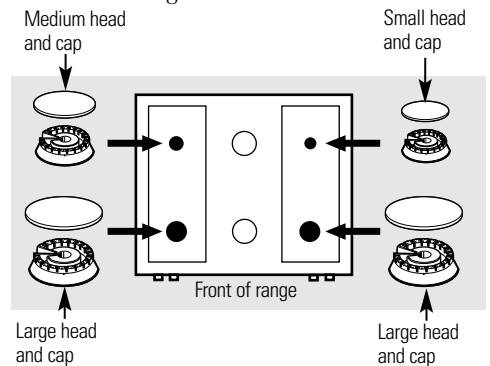

**2** Place the matching size caps onto the heads.

Make sure that the heads and caps are placed in the correct locations.

After cleaning, first replace the vent grille and vent grille cap. Replace the side grates so that they fit over the tabs on the vent grille. Make sure the grates are positioned securely over the burners and that they are stable and level.

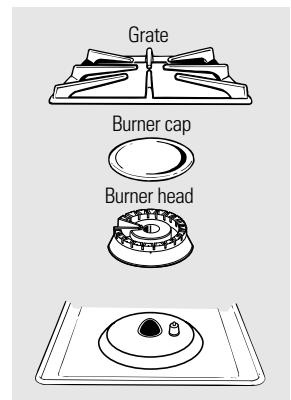

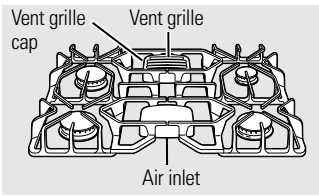

### Burner Grates, Vent Grille and Vent Grille Cap

Porcelain enamel burner grates, vent grille and vent grille cap should be washed regularly and, of course, after spills.

Wash them in hot, soapy water and rinse with clean water. You may also use abrasive cleaners and scouring pads, if needed. Dry them with a cloth—don't put them back on the cooktop wet.

Although they're durable, the grates, vent grille and vent grille cap will gradually lose their shine, regardless of the best care you can give them. This is due to their continual exposure to high temperatures.

Do not operate a burner for an extended period of time without cookware on the grate. The finish on the grate may chip without cookware to absorb the heat.

After cleaning, first replace the vent grille and the vent grille cap.

Replace the side grates so that they fit over the tabs on the vent grille. Make sure the grates are positioned securely over the burners and that they are stable and level.

#### Rubber Grate Feet

For stability, your cooktop has rubber feet on the burner grates. If any of these rubber feet should become damaged or lost, replace them immediately.

To order replacement rubber grate feet, please call our toll-free number:

**National Parts Center** .....800.626.2002  
**Rubber Grate Feet** .....#WB02T10101

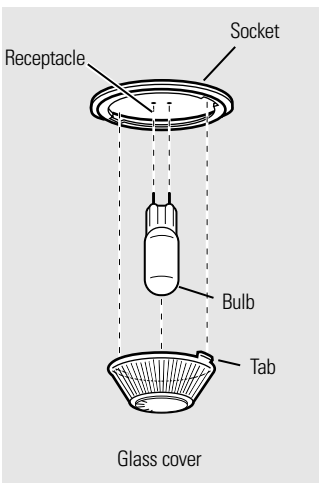

### Oven Light Bulbs (on some models)

**NOTE:** The glass cover should be removed only when cold. Wearing latex gloves may offer a better grip.

**CAUTION:** Before replacing your oven light bulb, disconnect the electrical power to the oven at the main fuse or circuit breaker panel.

Be sure to let the light cover and bulb cool completely.

For your safety, do not touch a hot bulb with bare hands or a damp cloth.

#### To remove:

- 1 Turn the glass cover counterclockwise 1/4 turn until the tabs of the glass cover clear the grooves of the socket.
- 2 Using gloves or a dry cloth, remove the bulb by pulling it straight out.

#### To replace:

- 1 Use a new 130-volt halogen bulb, not to exceed 50 watts.
- 2 Using gloves or a dry cloth, remove the bulb from its packaging. Do not touch the bulb with bare fingers.

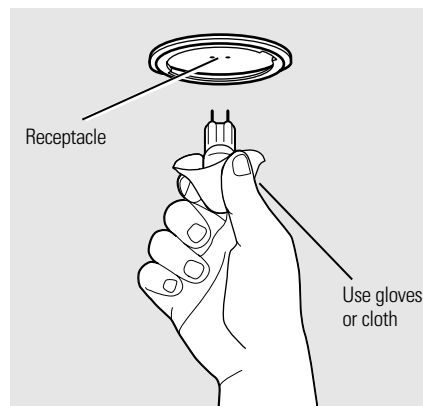

- 3 Push the bulb straight into the receptacle all the way.
- 4 Place the tabs of the glass cover into the grooves of the socket. Turn the glass cover clockwise 1/4 turn to engage.

For improved lighting inside the oven, clean the glass cover frequently using a wet cloth. This should be done when the oven is completely cool.

- 5 Reconnect electrical power to the oven.

## Care and cleaning of the range.

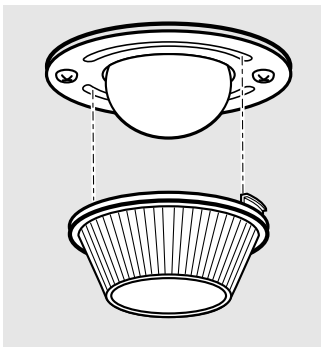

### Oven Light Replacement (on some models)

**CAUTION:** Before replacing your oven light bulb, disconnect the electrical power to the range at the main fuse or circuit breaker panel.

Be sure to let the light cover and bulb cool completely.

#### To remove the cover:

- 1 Twist lens counterclockwise about a quarter turn to remove.

*Do not remove any screws to remove the cover.*

- 2 Replace bulb with a 40-watt appliance bulb or two-prong halogen bulb as appropriate.

#### To replace the cover:

- 1 Line up tabs of lens in front of tabs on housing and rotate clockwise to engage.
- 2 Connect electrical power to the range.

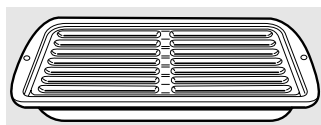

*Do not store a soiled broiler pan and grid anywhere in the range.*

### Broiler Pan and Grid

*Do not clean the broiler pan or grid in a self-cleaning oven.*

After broiling, remove the broiler pan from the oven. Remove the grid from the pan. Carefully pour out the grease from the pan into a proper container.

*Wash and rinse the broiler pan and grid in hot water with a soap-filled or plastic scouring pad.*

If food has burned on, sprinkle the grid with detergent while hot and cover with wet paper towels or a dishcloth. Soaking the pan will remove burned-on foods.

*Both the broiler pan and grid may be cleaned with a commercial oven cleaner.*

Both the broiler pan and grid can also be cleaned in a dishwasher.

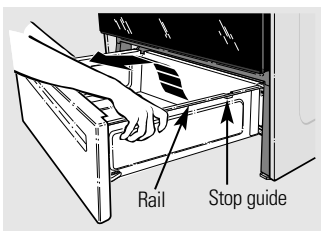

### Storage Drawer Removal

#### To remove the drawer:

- 1 Pull the drawer out until it stops.
- 2 Lift the front of the drawer until the stops clear the guides.
- 3 Remove the drawer.

#### To replace the drawer:

- 1 Place the drawer rails on the guides.
- 2 Push the drawer back until it stops.
- 3 Lift the front of the drawer and push back until the stops clear the guides.
- 4 Lower the front of the drawer and push back until it closes.

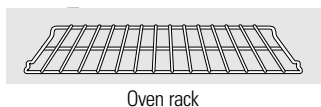

Oven rack

### Oven Racks

Clean the oven racks with an abrasive cleanser or scouring pad. After cleaning, rinse the racks with clean water and dry with a clean cloth.

**NOTE:** The oven racks may be cleaned in the self-cleaning oven. However, the oven racks will darken in color, lose their luster and become hard to slide if cleaned during the self-cleaning cycle.

To make the oven racks slide more easily, apply a small amount of cooking oil to a paper towel and wipe the edges of the oven racks with the paper towel.



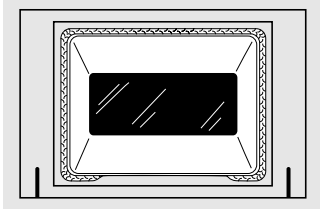

The gasket is designed with a gap at the bottom to allow for proper air circulation.

Do not rub or clean the door gasket—it has an extremely low resistance to abrasion.

If you notice the gasket becoming worn, frayed or damaged in any way or if it has become displaced on the door, you should have it replaced.

### Cleaning the Oven Door

#### To clean the inside of the door:

- Because the area inside the gasket is cleaned during the self-clean cycle, you do not need to clean this by hand.
- The area outside the gasket and the door liner can be cleaned with a soap-filled or plastic scouring pad, hot water and detergent. Rinse well with a vinegar and water solution.

#### To clean the outside of the door:

- Use soap and water to thoroughly clean the top, sides and front of the oven door. Rinse well. You may also use a glass cleaner to clean the glass

on the outside of the door. Do not let water drip into the vent openings.

- If any stain on the door vent trim is persistent, use a soft abrasive cleaner and a sponge-scrubber for best results.
- Spillage of marinades, fruit juices, tomato sauces and basting materials containing acids may cause discoloration and should be wiped up immediately. When surface is cool, clean and rinse.
- Do not use oven cleaners, cleaning powders or harsh abrasives on the outside of the door.

### Lift-Off Oven Door

The door is very heavy. Be careful when removing and lifting the door.

Do not lift the door by the handle.

#### To remove the door:

- 1 Fully open the door.
- 2 Pull the hinge locks down toward the door frame, to the unlocked position. A tool, such as a small flat-blade screwdriver, may be required.
- 3 Firmly grasp both sides of the door at the top.
- 4 Close door to the door removal position, which is halfway between the broil stop position and fully closed.
- 5 Lift door up and out until the hinge arm is clear of the slot.

#### To replace the door:

- 1 Firmly grasp both sides of the door at the top.

- 2 With the door at the same angle as the removal position, seat the indentation of the hinge arm into the bottom edge of the hinge slot. The notch in the hinge arm must be fully seated into the bottom of the slot.

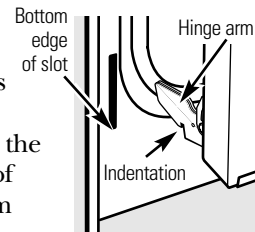

- 3 Fully open the door. If the door will not fully open, the indentation is not seated correctly in the bottom edge of the slot.

- 4 Push the hinge locks up against the front frame of the oven cavity to the locked position.

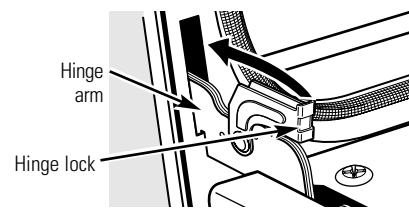

Push hinge locks up to lock.

- 5 Close the oven door.

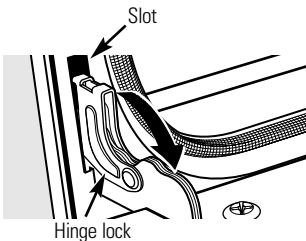

Pull hinge locks down to unlock.

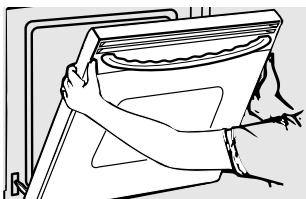

Removal position

## Care and cleaning of the range.

### To order:

To order CERAMA BRYTE® Stainless Steel Cleaning Polish and Conditioner, please call our toll-free number:

**National Parts Center . . 800.626.2002**

**www.GEAppliances.com**

**CERAMA BRYTE®  
Stainless Steel Cleaning Polish  
and Conditioner . . . . . # PM10X313**

### Stainless Steel Surfaces (on some models)

**Do not use a steel-wool pad; it will scratch the surface.**

- 1 Shake bottle well.
- 2 Place a small amount of CERAMA BRYTE® Stainless Steel Cleaning Polish and Conditioner on a **dry** cloth or **dry** paper towel.

- 3 Clean a small area (approximately 8" x 8"), rubbing with the grain of the stainless steel if applicable.
- 4 Dry and buff with a clean, dry paper towel or soft cloth.
- 5 Repeat as necessary.

### Painted Surfaces

Painted surfaces include the top and sides of the door, and the drawer front. Clean these with soap and water or a vinegar and water solution.

Do not use commercial oven cleaners, cleaning powders, steel wool or harsh abrasives on any painted surface.

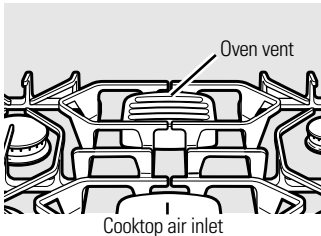

### Oven Vent and Cooktop Air Inlet

The oven is vented through an opening in the cooktop under the grille. The cooktop takes in air through the air inlet located through the cooktop.

Never cover these openings with aluminum foil or any other material. This would prevent the vents from working properly.

### Control Panel

*If desired, the touch pads may be turned off before cleaning.*

See the *Control Lockout* section.

Clean up splatters with a damp cloth.

Remove heavier soil with warm soapy water. Do not use abrasives of any kind.

*Turn on the touch pads after cleaning.*

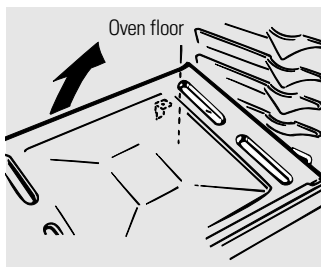

### Removable Oven Floor

**To remove the oven floor for easier cleaning:**

- 1 Remove the oven door using the instructions in the *Lift-Off Oven Door* section.
- 2 Grasp oven floor at the rear finger slots on each side, lift it up, push it back and pull it out.



- 3 Clean the oven floor with warm soapy water.

**IMPORTANT:** Always replace the removable floor before the next use.

# Before you call for service...



**Troubleshooting Tips**  
Save time and money! Review the charts on the following pages first and you may not need to call for service.

Problem	Possible Causes	What To Do
<b>Burners have yellow or yellow-tipped flames</b>	The combustion quality of burner flames needs to be determined visually.	<ul style="list-style-type: none"> <li>Use the illustrations below to determine if your burner flames are normal. If burner flames look like <b>A</b>, call for service. Normal burner flames should look like <b>B</b> or <b>C</b>, depending on the type of gas you use. With LP gas, some yellow tipping on outer cones is normal.</li> </ul> <div style="display: flex; justify-content: space-around; align-items: flex-end;"> <div style="text-align: center;">  <p><b>A–Yellow flames</b> Call for service</p> </div> <div style="text-align: center;">  <p><b>B–Yellow tips on outer cones</b> Normal for LP gas</p> </div> <div style="text-align: center;">  <p><b>C–Soft blue flames</b> Normal for natural gas</p> </div> </div>
<b>Control knobs will not turn</b>	Knob isn't pushed down.	<ul style="list-style-type: none"> <li>To turn from the <b>OFF</b> position, push the knob in and then turn.</li> </ul>
<b>Burners do not light</b>	<p>Plug on range is not completely inserted in the electrical outlet.</p> <p>Gas supply not connected or turned on.</p> <p>A fuse in your home may be blown or the circuit breaker tripped.</p> <p>Burner parts not replaced correctly.</p>	<ul style="list-style-type: none"> <li>Make sure electrical plug is plugged into a live, properly grounded outlet.</li> <li>See the Installation Instructions that came with your range.</li> <li>Replace the fuse or reset the circuit breaker.</li> <li>See the <i>Care and cleaning of the range</i> section.</li> </ul>
<b>Control Lockout feature is activated</b>		<ul style="list-style-type: none"> <li>If <b>LOC ON</b> appears in the display, the oven control is locked. Turn this feature off to use the oven. See the <i>Control Lockout</i> section.</li> </ul>
<b>Ticking sound of spark igniter persists after burner lights</b>	Control knob is still in the <b>LITE</b> position.	<ul style="list-style-type: none"> <li>Turn the knob out of the <b>LITE</b> position to the desired setting.</li> <li>Turn the burner off and relight. If ticking is still present, call for service.</li> </ul>
<b>Burner flames very large or yellow</b>	Improper air to gas ratio.	<ul style="list-style-type: none"> <li>If range is connected to LP gas, check all steps in the Installation Instructions that came with your range.</li> </ul>
<b>Oven light does not work</b>	<p>Light bulb is loose or defective.</p> <p>Switch operating light is broken.</p>	<ul style="list-style-type: none"> <li>Tighten or replace the bulb.</li> <li>Call for service.</li> </ul>
<b>Oven will not work</b>	<p>Plug on range is not completely inserted in the electrical outlet.</p> <p>A fuse in your home may be blown or the circuit breaker tripped.</p> <p>Oven controls improperly set.</p> <p>Door left in the locked position.</p>	<ul style="list-style-type: none"> <li>Make sure electrical plug is plugged into a live, properly grounded outlet.</li> <li>Replace the fuse or reset the circuit breaker.</li> <li>See the <i>Using the oven</i> section.</li> <li>If necessary, allow the oven to cool; then unlock the door.</li> </ul>

## Before you call for service...



### Troubleshooting Tips

<b>Problem</b>	<b>Possible Causes</b>	<b>What To Do</b>
<b>Food does not bake or roast properly</b>	Oven controls improperly set.	• See the <i>Using the oven</i> section.
	Rack position is incorrect or the rack is not level.	• See the <i>Using the oven</i> section.
	Incorrect cookware or cookware of improper size being used.	• See the <i>Using the oven</i> section.
	Oven thermostat needs adjustment.	• See the <i>Adjust the oven thermostat – Do it yourself!</i> section.
<b>Food does not broil properly</b>	Oven controls improperly set.	• Make sure you touch the <b>BROIL HI/LO</b> pad.
	Improper rack position being used.	• See the <i>Broiling Guide</i> .
	Cookware not suited for broiling.	• Use the broiling pan and grid that came with your range.
	Aluminum foil used on the the broiling pan and grid has not been fitted properly and slit as recommended.	• See the <i>Using the oven</i> section.
	In some areas the power (voltage) may be low.	• Preheat the broil element for 10 minutes. • Broil for the longest period of time recommended in the <i>Broiling Guide</i> .
<b>Oven temperature too hot or too cold</b>	Oven thermostat needs adjustment.	• See the <i>Adjust the oven thermostat – Do it yourself!</i> section.
<b>Oven door is crooked</b>	The door is out of position.	• Because the oven door is removable, it sometimes gets out of position during installation. Remove and replace the oven door. See the <i>Lift-Off Oven Door</i> section.
<b>Storage drawer is crooked</b>	Rear drawer support is on top of the guide rail.	• Reposition the drawer. See the <i>Storage Drawer Removal</i> instructions in the <i>Care and cleaning of your range</i> section.
<b>Storage drawer won't close</b>	Rear drawer support is on top of the guide rail.	• Reposition the drawer. See the <i>Storage Drawer Removal</i> instructions in the <i>Care and cleaning of your range</i> section.

<b>Problem</b>	<b>Possible Causes</b>	<b>What To Do</b>
<b>Clock and timer do not work</b>	Plug on range is not completely inserted in the electrical outlet.	<ul style="list-style-type: none"> <li>• Make sure electrical plug is plugged into a live, properly grounded outlet.</li> </ul>
	A fuse in your home may be blown or the circuit breaker tripped.	<ul style="list-style-type: none"> <li>• Replace the fuse or reset the circuit breaker.</li> </ul>
	Oven controls improperly set.	<ul style="list-style-type: none"> <li>• See the <i>Using the clock and timer</i> section.</li> </ul>
<b>Oven will not self-clean</b>	Oven controls improperly set.	<ul style="list-style-type: none"> <li>• See the <i>Using the self-cleaning oven</i> section.</li> </ul>
	Oven door is not in the locked position.	<ul style="list-style-type: none"> <li>• Make sure you move the door latch handle all the way to the right.</li> </ul>
<b>"Crackling" or "popping" sound</b>	This is the sound of the metal heating and cooling during both the cooking and cleaning functions.	<ul style="list-style-type: none"> <li>• This is normal.</li> </ul>
<b>Excessive smoking during a clean cycle</b>	Excessive soil.	<ul style="list-style-type: none"> <li>• Touch the <b>CLEAR/OFF</b> pad. Open the windows to rid the room of smoke. Wait until the light on the <b>SELF CLEAN</b> pad goes off. Wipe up the excess soil and reset the clean cycle.</li> </ul>
<b>Oven door will not open after a clean cycle</b>	Oven too hot.	<ul style="list-style-type: none"> <li>• Allow the oven to cool below locking temperature.</li> </ul>
<b>Oven not clean after a clean cycle</b>	Oven controls not properly set.	<ul style="list-style-type: none"> <li>• See the <i>Using the self-cleaning oven</i> section.</li> </ul>
	Oven was heavily soiled.	<ul style="list-style-type: none"> <li>• Clean up heavy spillovers before starting the clean cycle. Heavily soiled ovens may need to self-clean again or for a longer period of time.</li> </ul>
<b>"F—and a number or letter" flash in the display</b>	You have a function error code.	<ul style="list-style-type: none"> <li>• Touch the <b>CLEAR/OFF</b> pad. Put the oven back into operation.</li> </ul>
	If the function code repeats.	<ul style="list-style-type: none"> <li>• Disconnect all power to the range for at least 30 seconds and then reconnect power. If the function error code repeats, call for service.</li> <li>• If a function error code appears during the self-cleaning cycle, check the oven door latch. The latch may have been moved, if only slightly, from the locked position. Make sure the latch is moved to the right as far as it will go. Touch the <b>CLEAR/OFF</b> pad. Allow the oven to cool for one hour. Put the oven back into operation.</li> </ul>

## Before you call for service...



### Troubleshooting Tips

<b>Problem</b>	<b>Possible Causes</b>	<b>What To Do</b>
<b>Display flashes "bAd" then "linE" with a loud tone</b>	The installed connection from the house to the unit is miswired.	<ul style="list-style-type: none"> <li>Contact installer or electrician to correct miswire.</li> </ul>
<b>Control signals after entering cooking time or delay start</b>	You forgot to enter a bake temperature or cleaning time.	<ul style="list-style-type: none"> <li>Touch the <b>BAKE</b> pad and desired temperature or the <b>SELF CLEAN</b> pad and desired clean time.</li> </ul>
<b>Display goes blank</b>	A fuse in your home may be blown or the circuit breaker tripped.	<ul style="list-style-type: none"> <li>Replace the fuse or reset the circuit breaker.</li> </ul>
	The clock is in black-out mode.	<ul style="list-style-type: none"> <li>See the <i>Using the clock and timer</i> section.</li> </ul>
<b>Display flashes</b>	Power failure.	<ul style="list-style-type: none"> <li>Reset the clock.</li> </ul>
<b>Unable to get the display to show "SF"</b>	Oven control pads were not touched properly.	<ul style="list-style-type: none"> <li>The <b>BROIL HI/LO</b> and <b>BAKE</b> pads must be touched at the same time and held for 3 seconds.</li> </ul>
<b>Power outage, clock flashes</b>	Power outage or surge.	<ul style="list-style-type: none"> <li>Reset the clock. If the oven was in use, you must reset it by touching the <b>CLEAR/OFF</b> pad, setting the clock and resetting any cooking function.</li> </ul>
<b>"Burning" or "oily" odor emitting from the vent</b>	This is normal in a new oven and will disappear in time.	<ul style="list-style-type: none"> <li>To speed the process, set a self-clean cycle for a minimum of 3 hours. See the <i>Using the self-cleaning oven</i> section.</li> </ul>
<b>Strong odor</b>	An odor from the insulation around the inside of the oven is normal for the first few times the oven is used.	<ul style="list-style-type: none"> <li>This is temporary.</li> </ul>
<b>Fan noise</b>	A cooling fan may automatically turn on and off.	<ul style="list-style-type: none"> <li>This is normal. The cooling fan will turn off and on to cool internal parts. It may run after the oven is turned OFF.</li> </ul>

## GE Service Protection Plus™

GE, a name recognized worldwide for quality and dependability, offers you Service Protection Plus™—comprehensive protection on all your appliances—**No Matter What Brand!**

**Benefits Include:**

- Backed by GE
- All brands covered
- Unlimited service calls
- All parts and labor costs included
- No out-of-pocket expenses
- No hidden deductibles
- One 800 number to call

***We'll Cover Any Appliance.  
Anywhere. Anytime.\****

You will be completely satisfied with our service protection or you may request your money back on the remaining value of your contract. No questions asked. It's that simple.

Protect your refrigerator, dishwasher, washer and dryer, range, TV, VCR and much more—**any brand!** Plus there's no extra charge for emergency service and low monthly financing is available. Even icemaker coverage and food spoilage protection is offered. You can rest easy, knowing that all your valuable household products are protected against expensive repairs.

Place your confidence in GE and call us in the U.S. toll-free at **800.626.2224** for more information.

\*All brands covered, up to 20 years old, in the continental U.S.

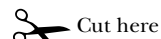

Please place in envelope and mail to:

***General Electric Company***  
**Warranty Registration Department**  
**P.O. Box 32150**  
**Louisville, KY 40232-2150**

# Consumer Product Ownership Registration

Dear Customer:

Thank you for purchasing our product and thank you for placing your confidence in us.

We are proud to have you as a customer!

Follow these three steps to protect your new appliance investment:

# 1

Complete and mail your Consumer Product Ownership Registration today. Have the peace of mind of knowing we can contact you in the unlikely event of a safety modification.

# 2

After mailing the registration below, store this document in a safe place. It contains information you will need should you require service. Our service number is 800.GE.CARES (800.432.2737).

# 3

Read your Owner's Manual carefully. It will help you operate your new appliance properly.

Model Number

Serial Number

**Important: If you did not get a registration card with your product, detach and return the form below to ensure that your product is registered, or register online at [www.GEAppliances.com](http://www.GEAppliances.com).**

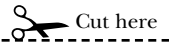

## Consumer Product Ownership Registration



Model Number

Serial Number

Mr.  Ms.  Mrs.  Miss

First Name

Last Name

Street Address

Apt. #

E-mail Address\*

City

State

Zip Code

Date Placed In Use  
Month

Day

Year

Phone Number --



**GE Appliances**

GE Consumer & Industrial  
Louisville, Kentucky  
[www.GEAppliances.com](http://www.GEAppliances.com)

\* Please provide your e-mail address to receive, via e-mail, discounts, special offers and other important communications from GE Appliances (GEA).

Check here if you do not want to receive communications from GEA's carefully selected partners.

**FAILURE TO COMPLETE AND RETURN THIS CARD DOES NOT DIMINISH YOUR WARRANTY RIGHTS.**

For more information about GEA's privacy and data usage policy, go to [www.GEAppliances.com](http://www.GEAppliances.com) and click on "Privacy Policy" or call 800.626.2224.



# Accessories.



## Looking For Something More?

You can find these accessories and many more at [www.GEAppliances.com](http://www.GEAppliances.com) or call 800.626.2002 (during normal business hours). Have your model number ready.

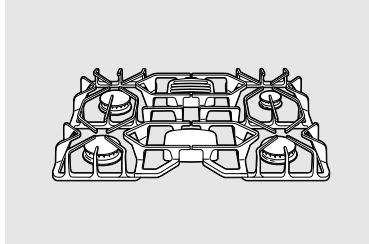

Grates

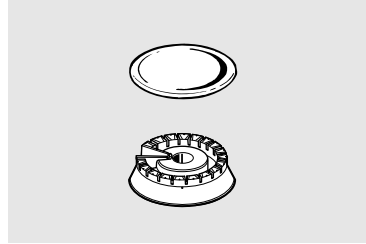

Surface Burner Heads & Caps

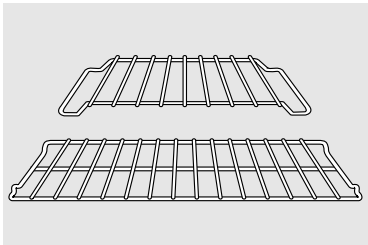

Oven Racks

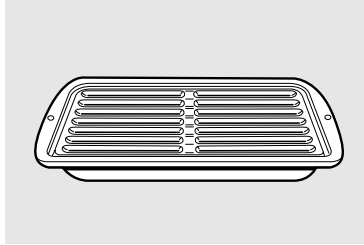

Broiler Pan



Cleaner and polish

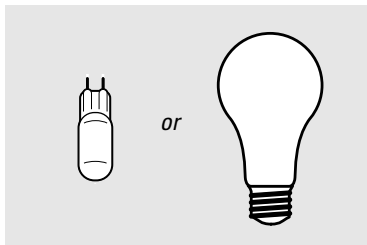

Light Bulbs

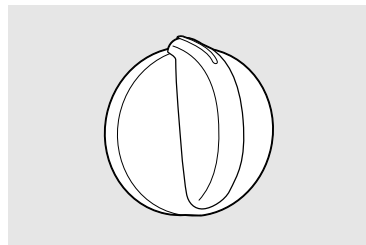

Knobs

Tired of discolored racks? Wishing you had extra-heavy-duty oven racks?

**NOW AVAILABLE** for your range:

GE's innovative, self-cleanable porcelain-coated oven racks!

- Heavy Duty
- Durable
- Able to be cleaned in a self-cleaning oven

Visit [www.GEAppliances.com](http://www.GEAppliances.com) for more information.

## GE Gas Range Warranty.



All warranty service provided by our Factory Service Centers, or an authorized Customer Care® technician. To schedule service, on-line, 24 hours a day, visit us at [www.GEAppliances.com](http://www.GEAppliances.com), or call 800.GE.CARES (800.432.2737).

Staple your receipt here.  
Proof of the original purchase date is needed to obtain service under the warranty.

### For The Period Of: GE Will Replace:

**One Year**  
From the date of the original purchase

**Any part** of the range which fails due to a defect in materials or workmanship. During this **full one-year warranty**, GE will also provide, **free of charge**, all labor and in-home service to replace the defective part.

### What GE Will Not Cover:

- Service trips to your home to teach you how to use the product.
- Improper installation, delivery or maintenance.
- Failure of the product if it is abused, misused, or used for other than the intended purpose or used commercially.
- Replacement of house fuses or resetting of circuit breakers.
- Damage to the product caused by accident, fire, floods or acts of God.
- Incidental or consequential damage caused by possible defects with this appliance.
- Damage caused after delivery.

*This warranty is extended to the original purchaser and any succeeding owner for products purchased for home use within the USA. In Alaska, the warranty excludes the cost of shipping or service calls to your home.*

*Some states do not allow the exclusion or limitation of incidental or consequential damages. This warranty gives you specific legal rights, and you may also have other rights which vary from state to state. To know what your legal rights are, consult your local or state consumer affairs office or your state's Attorney General.*

**Warrantor: General Electric Company, Louisville, KY 40225**

**Notes.**

---

<i><b>Safety Instructions</b></i>	<i><b>Operating Instructions</b></i>	<i><b>Care and Cleaning</b></i>	<i><b>Troubleshooting Tips</b></i>	<i><b>Consumer Support</b></i>
-----------------------------------	--------------------------------------	---------------------------------	------------------------------------	--------------------------------

## Consumer Support.

---



### *GE Appliances Website*

[www.GEAppliances.com](http://www.GEAppliances.com)

Have a question or need assistance with your appliance? Try the GE Appliances Website 24 hours a day, any day of the year! For greater convenience and faster service, you can now download Owner's Manuals, order parts, catalogs, or even schedule service on-line. You can also "Ask Our Team of Experts™" your questions, and so much more...



### *Schedule Service*

[www.GEAppliances.com](http://www.GEAppliances.com)

Expert GE repair service is only one step away from your door. Get on-line and schedule your service at your convenience 24 hours any day of the year! Or call 800.GE.CARES (800.432.2737) during normal business hours.



### *Real Life Design Studio*

[www.GEAppliances.com](http://www.GEAppliances.com)

GE supports the Universal Design concept—products, services and environments that can be used by people of all ages, sizes and capabilities. We recognize the need to design for a wide range of physical and mental abilities and impairments. For details of GE's Universal Design applications, including kitchen design ideas for people with disabilities, check out our Website today. For the hearing impaired, please call 800.TDD.GEAC (800.833.4322).



### *Extended Warranties*

[www.GEAppliances.com](http://www.GEAppliances.com)

Purchase a GE extended warranty and learn about special discounts that are available while your warranty is still in effect. You can purchase it on-line anytime, or call 800.626.2224 during normal business hours. GE Consumer Home Services will still be there after your warranty expires.

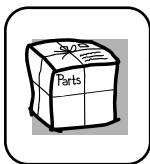

### *Parts and Accessories*

[www.GEAppliances.com](http://www.GEAppliances.com)

Individuals qualified to service their own appliances can have parts or accessories sent directly to their homes (VISA, MasterCard and Discover cards are accepted). Order on-line today, 24 hours every day or by phone at 800.626.2002 during normal business hours.

**Instructions contained in this manual cover procedures to be performed by any user. Other servicing generally should be referred to qualified service personnel. Caution must be exercised, since improper servicing may cause unsafe operation.**

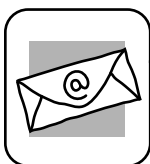

### *Contact Us*

[www.GEAppliances.com](http://www.GEAppliances.com)

If you are not satisfied with the service you receive from GE, contact us on our Website with all the details including your phone number, or write to: General Manager, Customer Relations  
GE Appliances, Appliance Park  
Louisville, KY 40225



### *Register Your Appliance*

[www.GEAppliances.com](http://www.GEAppliances.com)

Register your new appliance on-line—at your convenience! Timely product registration will allow for enhanced communication and prompt service under the terms of your warranty, should the need arise. You may also mail in the pre-printed registration card included in the packing material.