



Self-Cleaning Double Oven Gas RANGES

SAFETY INFORMATION..... 3

USING THE RANGE

In Case of a Power Failure 8

Surface Burners 8

Griddle10

Oven Controls..... 11

Options.....12

Settings12

Sabbath Mode.....14

Oven Racks 15

Aluminum Foil and Oven Liners.....16

Cookware16

Cooking Modes.....16

Oven Air Vents17

Oven Probe18

Cooking Guide19

CARE AND CLEANING

Range - Exterior..... 20

Range - Interior21

Cooktop..... 22

Door 24

Oven Probe 24

Oven Light..... 25

Oven Door..... 26

TROUBLESHOOTING TIPS..... 27

WARRANTY..... 30

ACCESSORIES31

PRODUCT REGISTRATION..... 33

CONSUMER SUPPORT 36

OWNER'S MANUAL

CCGS995,
PCGS960

Write the model and serial numbers here:

Model # _____

Serial # _____

You can find the rating label on the front behind the range drawer.

THANK YOU FOR MAKING GE APPLIANCES A PART OF YOUR HOME.

Whether you grew up with GE Appliances, or this is your first, we're happy to have you in the family.

We take pride in the craftsmanship, innovation and design that goes into every GE Appliances product, and we think you will too. Among other things, registration of your appliance ensures that we can deliver important product information and warranty details when you need them.

Register your GE appliance now online. Helpful websites and phone numbers are available in the Consumer Support section of this Owner's Manual. You may also mail in the pre-printed registration card included in the packing material.



GE APPLIANCES

IMPORTANT SAFETY INFORMATION

READ ALL INSTRUCTIONS BEFORE USING THE APPLIANCE

⚠ WARNING Read all safety instructions before using the product. Failure to follow these instructions may result in fire, electrical shock, serious injury or death.

⚠ WARNING If the information in this manual is not followed exactly, a fire or explosion may result, causing property damage, personal injury or death.

- Do not store or use gasoline or other flammable vapors and liquids in the vicinity of this or any other appliance.
- **WHAT TO DO IF YOU SMELL GAS**
 - Do not try to light any appliance.
 - Do not touch any electrical switch; do not use any phone in your building.
 - Immediately call your gas supplier from a neighbor's phone. Follow the gas supplier's instructions.
 - If you cannot reach your gas supplier, call the fire department.
- Installation and service must be performed by a qualified installer, service agency or the gas supplier.

ANTI-TIP DEVICE

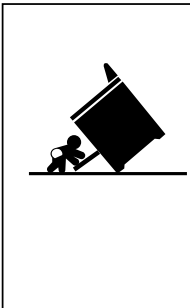

⚠ WARNING

Tip-Over Hazard

- A child or adult can tip the range and be killed.
- Install the anti-tip bracket to the wall or floor.
- Engage the range to the anti-tip bracket by sliding the range back such that the foot is engaged.
- Re-engage the anti-tip bracket if the range is moved.
- Failure to do so can result in death or serious burns to children or adults.

To reduce the risk of tipping the range, the range must be secured by a properly installed anti-tip bracket. See installation instructions shipped with the bracket for complete details before attempting to install.

For Free-Standing and Slide-In Ranges

To check if the bracket is installed and engaged properly, look underneath the

range to see that the rear leveling leg is engaged in the bracket. On some models, the storage drawer or kick panel can be removed for easy inspection. If visual inspection is not possible, slide the range forward, confirm the anti-tip bracket is securely attached to the floor or wall, and slide the range back so the rear leveling leg is under the anti-tip bracket.

If the range is pulled from the wall for any reason, always repeat this procedure to verify the range is properly secured by the anti-tip bracket.

Never completely remove the leveling legs or the range will not be secured to the anti-tip device properly.

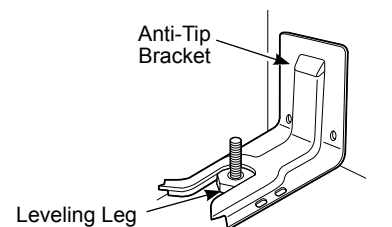

Free-Standing and Slide-In Ranges

READ AND SAVE THESE INSTRUCTIONS

IMPORTANT SAFETY INFORMATION

READ ALL INSTRUCTIONS BEFORE USING THE APPLIANCE

⚠ WARNING GENERAL SAFETY INSTRUCTIONS

⚠ WARNING NEVER use this appliance as a space heater to heat or warm the room. Doing so may result in carbon monoxide poisoning and overheating of the oven.

- Use this appliance for its intended purpose as described in this owner's manual.
- Have your range installed and properly grounded by a qualified installer in accordance with the provided installation instructions.
- Any adjustment and service should be performed only by a qualified gas range installer or service technician. Do not attempt to repair or replace any part of your range unless it is specifically recommended in this manual.
- Your range is shipped from the factory set for use with natural gas. It can be converted for use with propane gas. If required, these adjustments must be made by a qualified technician in accordance with the installation instructions and local codes. The agency performing this work assumes responsibility for the conversion.
- Have the installer show you the location of the range gas shut-off valve and how to turn it off if necessary.
- Plug your range into a 120-volt grounded outlet only. Do not remove the round grounding prong from the plug. If in doubt about the grounding of the home electrical system, it is your responsibility and obligation to have an ungrounded outlet replaced with a properly grounded, three prong outlet in accordance with the National Electrical Code. Do not use an extension cord with this appliance.
- Before performing any service, unplug the range or disconnect the power supply at the household distribution panel by removing the fuse or switching off the circuit breaker.
- Be sure all packing materials are removed from the range before operating to prevent ignition of these materials.
- Avoid scratching or impacting glass doors, cooktops, or control panels. Doing so may lead to glass breakage. Do not cook on a product with broken glass. Shock, fire, or cuts may occur.
- Do not leave children alone or unattended in an area where an appliance is in use. They should never be allowed to climb, sit or stand on any part of the appliance.
- **⚠ CAUTION** Do not store items of interest to children in cabinets above an oven - children climbing on the oven to reach items could be seriously injured.
- Never block the vents (air openings) of the range. They provide the air inlets and outlets that are necessary for the range to operate properly with correct combustion. Air openings are located at the rear of the cooktop, at the top and bottom of the oven door, and at the bottom of the range under the warming drawer, lower oven drawer or kick panel.
- Use only dry pot holders—moist or damp pot holders on hot surfaces may result in burns from steam. Do not let pot holders touch surface burners, burner grate, or oven heating element. Do not use a towel or other bulky cloth in place of pot holders.
- Do not touch the heating elements or the interior surface of the oven. These surfaces may be hot enough to burn even though they are dark in color. During and after use, do not touch, or let clothing or other flammable materials contact any interior area of the oven; allow sufficient time for cooling first. Other surfaces of the appliance may become hot enough to cause burns. Potentially hot surfaces include the burners, grates, oven vent opening, surfaces near the opening, and crevices around the oven door.
- Do not heat unopened food containers. Pressure could build up and the container could burst, causing an injury.
- Cook food thoroughly to help protect against foodborne illness. Minimum safe food temperature recommendations can be found at www.IsItDoneYet.gov and www.fsis.usda.gov. Use a food thermometer to take food temperatures and check several locations.
- Do not allow anyone to climb, stand or hang on the oven door, drawer or cooktop. They could damage the range or tip it over causing severe injury or death.

READ AND SAVE THESE INSTRUCTIONS

IMPORTANT SAFETY INFORMATION

READ ALL INSTRUCTIONS BEFORE USING THE APPLIANCE

▲WARNING KEEP FLAMMABLE MATERIALS AWAY FROM THE RANGE

Failure to do so may result in fire or personal injury.

- Do not store or use flammable materials in an oven or near the cooktop, including paper, plastic, pot holders, linens, wall coverings, curtains, drapes and gasoline or other flammable vapors and liquids.
- Never wear loose-fitting or hanging garments while using the appliance. These garments may ignite if they contact hot surfaces causing severe burns.
- Do not let cooking grease or other flammable materials accumulate in or near the range. Grease in the oven or on the cooktop may ignite.

▲WARNING IN THE EVENT OF A FIRE, TAKE THE FOLLOWING STEPS TO PREVENT INJURY AND FIRE SPREADING

- Do not use water on grease fires. Never pick up a flaming pan. Turn the controls off. Smother a flaming pan on a surface unit by covering the pan completely with a well-fitting lid, cookie sheet or flat tray. Use a multi-purpose dry chemical or foam-type fire extinguisher.
- If there is a fire in the oven during baking, smother the fire by closing the oven door and turning the oven off or by using a multi-purpose dry chemical or foam-type fire extinguisher.
- If there is a fire in the oven during self-clean, turn the oven off and wait for the fire to go out. Do not force the door open. Introduction of fresh air at self-clean temperatures may lead to a burst of flame from the oven. Failure to follow this instruction may result in severe burns.

▲WARNING COOKTOP SAFETY INSTRUCTIONS

- Never leave the surface burners unattended at medium or high heat settings. Foods, especially oily foods, may ignite resulting in fire that could spread to surrounding cabinets.
- Never leave oil unattended while frying. If allowed to heat beyond its smoking point, oil may ignite resulting in fire that may spread to surrounding cabinets. Use a deep fat thermometer whenever possible to monitor oil temperature.
- To avoid oil spillover and fire, use the minimum amount of oil when using a shallow pan-frying and avoid cooking frozen foods with excessive amounts of ice.
- Use proper pan size and avoid pans that are unstable or easily tipped. Select cookware that is matched to the size of the burner. Burner flames should be adjusted so that they do not extend beyond the bottom of the pan. Excessive flame may be hazardous.
- Always use the LITE position when igniting the top burners and make sure the burners have ignited.
- When using glass/ceramic cookware, make sure it is suitable for cooktop service; others may break because of sudden change in temperature.
- To minimize the possibility of burns, ignition of flammable materials and spillage, the handle of a container should be turned toward the center of the range without extending over nearby burners.
- Do not use a wok with a round metal support ring. The ring may trap heat and block air to the burner resulting in a carbon monoxide hazard.
- Do not attempt to lift the cooktop. Doing so may damage the gas tubing to the surface burners resulting in a gas leak and risk of fire.
- When disabling Lock Control (on some models), make sure the surface controls are set to the OFF position. This will prevent unintended gas flow from the burners.
- Do not use aluminum foil to cover the grates or line any part of the cooktop. Doing so may result in carbon monoxide poisoning, overheating of the cooktop surfaces, or a potential fire hazard.

READ AND SAVE THESE INSTRUCTIONS

IMPORTANT SAFETY INFORMATION

READ ALL INSTRUCTIONS BEFORE USING THE APPLIANCE

⚠ WARNING OVEN SAFETY INSTRUCTIONS

⚠ WARNING NEVER cover any slots, holes, or passages in the oven bottom or cover an entire rack with materials such as aluminum foil or oven liners. Doing so blocks air flow through the oven and may cause carbon monoxide poisoning. Never place foil or oven liners on the oven bottom. They can trap heat causing risk of smoke or fire.

- Stand away from the range when opening the oven door. Hot air or steam which escapes can cause burns to hands, face and/or eyes.
- Never place cooking utensils, pizza or baking stones, or any type of foil or liner on the oven floor. These items can trap heat or melt, resulting in damage to the product and risk of shock, smoke or fire.
- Place oven racks in desired location while oven is cool. If rack must be moved while oven is hot, be careful to avoid touching hot surfaces.
- Do not leave items such as paper, cooking utensils, or food in the oven when not in use. Items stored in an oven can ignite.
- Do not leave items on the cooktop near the oven vent. Items may overheat resulting in a risk of fire or burns.
- Never broil with door open. Open-door broiling is not permitted due to overheating of control knobs.

⚠ WARNING SELF-CLEANING OVEN SAFETY INSTRUCTIONS

The self-cleaning feature operates the oven at temperatures high enough to burn away food soils in the oven. Follow these instructions for safe operation.

- Do not touch oven surfaces during self-clean operation. Keep children away from the oven during self-cleaning. Failure to follow these instructions may cause burns.
- Before operating the self-clean cycle, remove pans, shiny metal oven racks, and other utensils from the oven. Only porcelain-coated oven racks may be left in the oven.
- Before operating the self-clean cycle, wipe grease and food soils from the oven. Excessive amount of grease may ignite leading to smoke damage to your home.
- If the self-cleaning mode malfunctions, turn the oven off and disconnect the power supply. Have it serviced by a qualified technician.
- Do not use oven cleaners. No commercial oven cleaner or oven liner protective coating of any kind should be used in or around any part of the oven.
- Do not clean the door gasket. The door gasket is essential for a good seal. Care should be taken not to rub, damage or move the gasket.
- **IMPORTANT:** The health of some birds is extremely sensitive to the fumes given off during the self-cleaning cycle of any range. Move birds to another well-ventilated room.

READ AND SAVE THESE INSTRUCTIONS

IMPORTANT SAFETY INFORMATION

READ ALL INSTRUCTIONS BEFORE USING THE APPLIANCE

STATE OF CALIFORNIA PROPOSITION 65 WARNINGS

▲WARNING

This product contains one or more chemicals known to the State of California to cause cancer, birth defects or other reproductive harm.

Self-clean electric ovens: Self clean ovens can cause low level exposure to some of the Proposition 65 substances, including carbon monoxide, during the cleaning cycle. Exposure to these substances can be minimized by opening a window or using a ventilation fan or hood.

Remote Enable Equipment

This device complies with part 15 of the FCC Rules. Operation is subject to the following two conditions: (1) This device may not cause harmful interference, and (2) this device must accept any interference received, including interference that may cause undesired operation.

The wireless communication equipment installed on this range has been tested and found to comply with the limits for a Class B digital device, pursuant to part 15 of the FCC Rules. These limits are designed to:

(a) provide reasonable protection against harmful interference in a residential installation. This equipment generates, uses, and can radiate radio frequency energy and, if not installed and used in accordance with the instructions, may cause harmful interference to radio communications. However, there is no guarantee that interference will not occur in a particular installation. If this equipment does cause harmful interference to radio or television reception, which can be determined by turning the equipment off and on, the user is encouraged to try to correct the interference by one or more of the following measures:

- Reorient or relocate the receiving antenna.
- Increase the separation between the equipment and receiver.
- Connect the equipment into an outlet on a circuit different from that to which the receiver is connected.
- Consult the dealer or an experienced radio/TV technician for help.

(b) accept any interference received, including interference that may cause undesired operation of the device.

Note that any changes or modifications to the wireless communication device installed on this oven that are not expressly approved by the manufacturer could void the user's authority to operate the equipment.

How to Remove Protective Shipping Film and Packaging Tape

Carefully grasp a corner of the protective shipping film with your fingers and slowly peel it from the appliance surface. Do not use any sharp items to remove the film. Remove all of the film before using the appliance for the first time.

To assure no damage is done to the finish of the product, the safest way to remove the adhesive from packaging tape on new appliances is an application of a household liquid dishwashing detergent. Apply with a soft cloth and allow to soak.

NOTE: The adhesive must be removed from all parts. It cannot be removed if it is baked on.

READ AND SAVE THESE INSTRUCTIONS

In Case of a Power Failure

In the event of a power failure, the oven is inoperable and no attempt should be made to operate it. However, the surface burners may be lit with a match. Using extreme caution, hold a lit match near the ports beneath

the surface burner cap, then slowly turn the knob to the LITE position. Once lit, surface burners will continue to operate normally.

Surface Burners

Lighting a Surface Burner

▲WARNING Burners should be operated only when covered by cookware. Burner flames not covered by cookware present a risk of fire or clothing ignition. Never let flames extend beyond the sides of the cookware. Failure to comply may result in serious injury.

Make sure all burners are in their correct locations and fully assembled before attempting to operate any burner. Select a burner and find its control knob. Push the knob in and turn it to the LITE position.

You will hear a clicking noise—the sound of the electric spark igniting the burner. When one burner is turned to LITE, all burners will spark. Sparking will continue as long as the knob remains at LITE. Once gas is ignited, turn the knob to adjust the flame size.

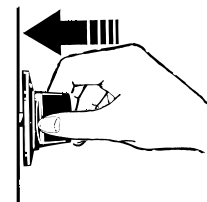

Push the control knob in and turn it to the LITE position.

Automatic Reignition (on some models)

The burners on this range will automatically relight if the flame goes out.

Selecting a Flame Size

Watch the flame, not the knob, as you adjust heat. When rapid heating is desired, the flame size should match the size of the cookware you are using. Flames larger than the bottom of the cookware will not heat faster and may be hazardous.

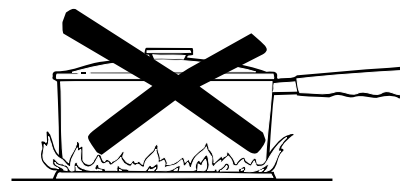

These flames are too large for the pot

Using the Surface Burners

NOTES:

- Do not operate the burner for an extended period of time without cookware on the grate. The finish on the grate may discolor or chip without cookware to absorb the heat.
- Do not attempt to disassemble any burner while another burner is on. Damage to the product may occur.
- Be sure the burners and grates are cool before you place your hand, a pot holder or cleaning materials on them.

Your rangetop has sealed gas burners that offer convenience, cleanability and flexibility for a wide range of cooking applications.

The smallest burner is the simmer burner. A simmer burner turned down to LO provides precise cooking performance for foods such as delicate sauces that require low heat for a long cooking time.

The extra-large burner is designed to quickly bring large amounts of liquid to a boil. Some models have a POWER BOIL™ setting especially designed for use with cookware with a diameter of 11 inches (27.4 cm) or larger.

Types of Surface Burners

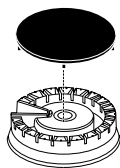

Round Burner

Use this burner for general cooking purposes. Size cookware appropriately to the flames.

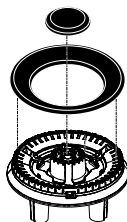

**Multi-Ring Burner
(on some models)**

Use this burner for large cookware or for simmering applications.



**Dual Oval Burner
(on some models)**

Use this burner to cook on the griddle or with small cookware.

Surface Burners (Cont.)

Multi-Ring Burner (some models)

For large cookware, activate all rings by setting the burner between Hi and Med.

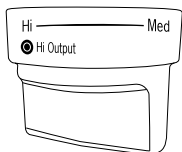

Side View Of The Multi-Ring Burner Knob

For small cookware or low heating applications, only activate the inner rings by setting the burner between Lo and Sim.

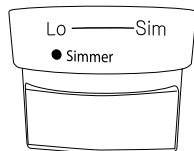

Dual Oval Burner (some models)

For small cookware, only activate the round burner.

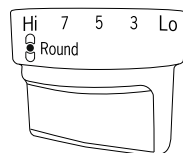

Side View Of The Dual Oval Burner Knob

When using a griddle, activate both the oval and round burner sections.

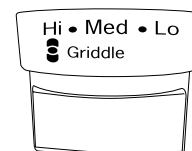

Top-of-Range Cookware

Aluminum: Medium-weight cookware is recommended because it heats quickly and evenly. Most foods brown evenly in an aluminum skillet. Use saucepans with tight-fitting lids when cooking with minimum amounts of water.

Stainless Steel: This metal alone has poor heating properties and is usually combined with copper, aluminum or other metals for improved heat distribution. Combination metal skillets usually work satisfactorily if they are used with medium heat or as the manufacturer recommends.

Cast-Iron: If heated slowly, most skillets will give satisfactory results.

Enamelware: Under some conditions, the enamel of some cookware may melt. Follow the cookware manufacturer's recommendations for cooking methods.

Glass: There are two types of glass cookware—those for oven use only and those for top-of-range cooking (saucepans, coffee and teapots). Glass conducts heat very slowly.

Heatproof Glass Ceramic: Can be used for either surface or oven cooking. It conducts heat very slowly and cools very slowly. Check the cookware manufacturer's directions to be sure it can be used on gas ranges.

Stove Top Grills

Do not use an after-market stove top grill on your gas surface burners. A stove top grill will cause incomplete combustion resulting in carbon monoxide levels above allowable standards. This could be hazardous to your health.



Do not use stove top grills

Using a Wok

Use only a flat-bottomed wok with a diameter of 14 inches (35.6 cm) or less. Make sure the wok bottom sits flat on the grate.

Do not use a wok support ring. Placing the ring over the burner or grate may cause the burner to work improperly, resulting in carbon monoxide levels above allowable standards. This could be hazardous to your health.



Use a flat-bottomed wok.

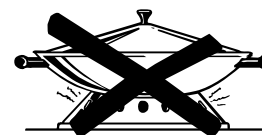

Griddle (on some models)

▲WARNING Fire Hazard

- Use care when cooking greasy foods. Spilled grease may result in fire.
- Never place any items on the griddle when it is not in use. Heat from surrounding burners can heat the griddle and may result in fire.
- Place and remove the griddle only when griddle is cool and all surface burners are turned OFF.

Using Your Cast Iron Griddle

The ribbed side of the reversible griddle can be used for food normally grilled.

Your griddle provides an extra-large cooking surface for meats, pancakes and other foods usually prepared in a skillet. Before first use, rinse with hot water and dry thoroughly. Prepare the surface with cooking spray or vegetable oil.

Positioning Your Griddle

The cast-iron griddle can only be used over the center burner(s) of the rangetop. To position the griddle, remove the center grate (if present), and replace it with the griddle. Do not turn on the center burner(s) until you are certain the griddle has been positioned correctly.

Preheating Your Griddle

For models with a non-reversible griddle, preheat your griddle by setting both center burners to 4 for 5-10 minutes before placing food on the griddle. For models with a reversible griddle, preheat your griddle by setting your center burner to Hi for 5-10 minutes before placing food on the griddle. Once the griddle is preheated, turn the knob on the burner(s) to the cook setting outlined in the table.

Griddle Precautions:

- Do not place the griddle in a microwave oven.
- Do not clean your griddle in the dishwasher.
- If something has spilled under the griddle, it should be cleaned up as soon as possible to prevent “baked on” food soil.
- Do not allow grease to accumulate under the griddle as it can be a fire hazard. Clean under the griddle with hot, soapy water as soon as it is cool.

Preseasoned Cast-Iron Griddle

Type of Food	Cook Setting
Bacon	3
Breakfast Sausage Links	3
Eggs	1
Grilled Cheese	2
Hamburgers	3
Pancakes	2
Warming Tortillas	1

Cook settings may need to be reduced if the griddle is used for an extended time.

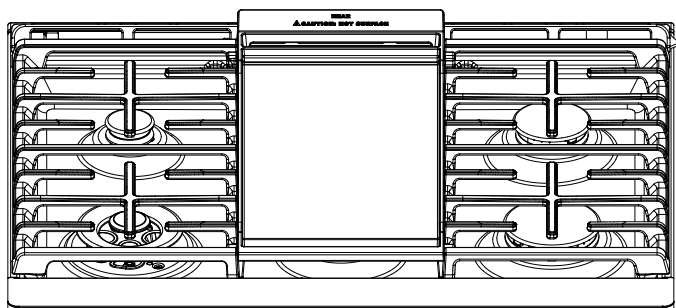

Replace the center grate with the non-reversible cast iron griddle

Preseasoned Reversible Cast-Iron Griddle

Type of Food	Cook Setting
Bacon	Med
Breakfast Sausage Links	Med
Eggs	Lo
Grilled Cheese	Med
Hamburgers	Med
Pancakes	Med
Warming Tortillas	Lo

Cook settings may need to be reduced if the griddle is used for an extended time.

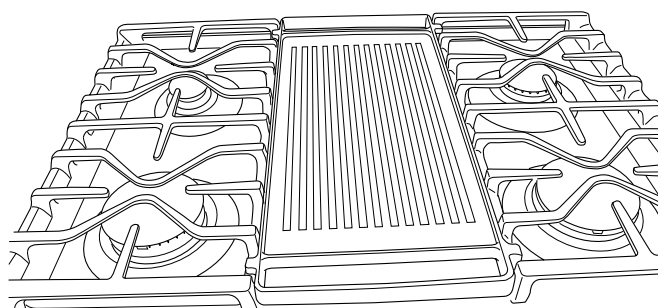

Replace the center grate with the reversible cast iron griddle

Oven Controls

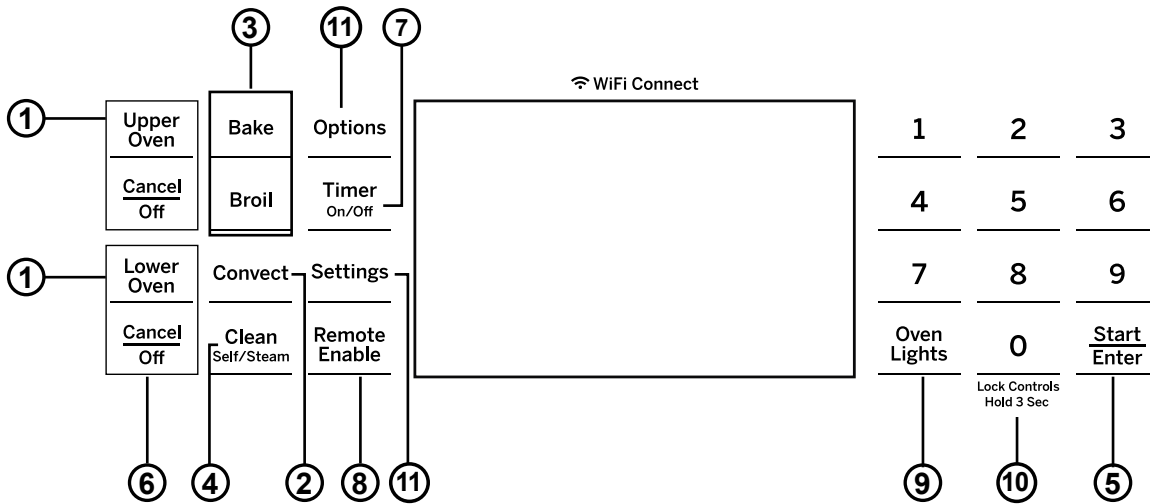

- 1. Upper Oven and Lower Oven:** Designates which oven the controls will operate. Select an oven before following the steps for starting a cooking or cleaning mode.
- 2. Convection Cooking Modes:** Convection cooking modes use increased air circulation to improve performance. See the Cooking Modes section for more information.
- 3. Traditional Cooking Modes:** Your oven has the following traditional cooking modes: Bake, Broil, and Warm. See the Cooking Modes section for more information.
- 4. Clean:** Your oven has two cleaning modes: Self Clean and Steam Clean. See the CARE AND CLEANING: Range – Interior section for important information about using these modes.
- 5. Start:** Must be pressed to start any cooking, cleaning, or timed function. Also used to start the Warming Zone on the cooktop.
- 6. Cancel/Off:** Cancels ALL oven operations except the clock and timer. Does NOT cancel the Warming Zone on the cooktop.
- 7. Timer:** Works as a countdown timer. Press the **Timer** pad and number pads to program the time in hours and minutes. Press the **Start** pad. The timer countdown is complete. To turn the timer off press the **Timer** pad.
- 8. Remote Enable:** Allows you to control your oven remotely. The oven must be connected to WiFi before Remote Enable can be activated. For instructions on how to connect your oven, see the WiFi Connect/Remote Enable section under Settings in this manual.
- 9. Oven Light:** Turns the oven light on or off.
- 10. Lock Controls:** Locks out the control so that pressing the pads does not activate the controls. Press and hold the **0** pad, for three seconds to lock or unlock the control. **Cancel/Off** is always active, even when the control is locked.
- 11. Options and Settings:** The Options and Settings pads open up more detailed menus in the display that allow access to additional functions and cooking modes. For each you select the function in the display using the associated number pad. You can exit at any time by pressing the **Options** or **Settings** pad again. See the Settings, Options, and Cooking Modes Sections for more details.

Options

The options pad opens up a menu of more cooking modes when the oven is off. It opens a menu with additional features if a cooking mode is already in process. You can exit the menu at any time by pressing the **Options** pad again.

You must first select a mode (bake, convection bake, convection roast) and then select Options to get to the following functions.

Cook Time

Counts down cooking time and turns off the oven when the cooking time is complete. Select a desired cooking mode. Use the number pads to program a baking temperature. Press the **Options** pad and select **Cook Time**. Use the number pad to program cook time in hours and minutes. Then press **Start/Enter**. This can only be used with Bake, Convection Bake, and Convection Roast.

Delay Time

Delays when the oven will turn on. Use this to set a time when you want the oven to start. Select a desired cooking mode. Use the number pad to program a baking temperature. Press the **Options** pad and select **Delay Time**. Use the number pads to program the time of day for the oven to turn on, and then press **Start/Enter**. Delay Time is not available with all modes.

NOTE: When using the Delay Time feature, foods that spoil easily – such as milk, eggs, fish, stuffing, poultry, and port – should not be allowed to sit for more than 1 hour before or after cooking. Room temperature promotes the growth of harmful bacteria. Be sure that the oven light is off because heat from the bulb will speed harmful bacteria growth.

Oven Probe (Lower Oven Only)

NOTE: Only accessible through traditional and convection cooking modes.

Monitors internal food temperature and turns the oven off when the food reaches the programmed temperature. Insert the probe, press the desired cooking mode, and program the probe temperature. See the Cooking Modes Section for more information. The probe can only be used with Bake, Convection Bake, and Convection Roast.

Settings

The Options and Settings pads open up more detailed menus in the display that allow access to additional functions. For each you select the function in the display using the associated number pad. You can exit at any time by pressing the Options or Settings pad again.

WiFi Connect and Remote Enable

Your oven is designed to provide you with two-way communication between your appliance and smart device. By using the WiFi Connect features, you will be able to control essential oven operations such as temperature settings, timers and cooking modes using your smartphone or tablet.*

Select **Settings** then **Wifi** - follow the instructions on your oven display and phone app. It is necessary to turn on WiFi before using Remote Enable on your oven.

Connecting your WiFi Connect Enabled Oven

What you will need

Your GE Appliances oven uses your existing home WiFi network to communicate between the appliance and your smart device. In order to setup your GE Appliances oven, you will need to gather some information:

1. Each GE Appliances oven has a connected appliance information label that includes an Appliance Network Name and Password. These are the two important details that you will need to connect to the appliance. The label is typically located inside the door of the oven or drawer.

Connected Appliance Information	
FCC: ZKJ-WCATA001	Network: GE_XXXXXX_XXXX
IC: 10229A-WCATA001	Password: XXXXXXXX
MAC ID: XX - XX - XX - XX - XX - XX	PT. NO. 229C6272G001-0

Sample Label

2. Have your smart phone or tablet ready with the ability to access the internet and download apps.
3. You will need to know the password of your home WiFi router. Have this password ready while you are setting up your GE Appliances oven.

Connect your GE Appliances oven

1. On your smart phone or tablet visit www.GEAppliances.com/connect to learn more about connected appliance features and to download the appropriate app.
2. Follow the app onscreen instructions to connect your GE Appliances oven.
3. Once the process is complete, the connection light located on your GE Appliances oven display will stay on solid and the app will confirm you are connected.

* Compatible Apple or Android devices and home WiFi network required.

Settings





WiFi Connect and Remote Enable (cont.)

- If the connection light does not turn on or is blinking, follow the instructions on the app to reconnect. If issues continue, please call the Connected Call Center 1.866.626.2000 and ask for assistance regarding oven wireless connectivity.

To connect additional smart devices, repeat steps 1 and 2.

Note that any changes or modifications to the remote enable device installed on this oven that are not expressly approved by the manufacturer could void the user's authority to operate the equipment.

REMOTE STARTING YOUR OVEN

To be able to start the oven remotely once connected to WiFi, press the **Remote Enable** pad and the  icon will turn on in the display. The oven can now be remotely started with a connected device. Opening an oven door or turning off the oven will turn off the  icon. The  icon must be lit to start the oven remotely. The  icon is not required to change the oven temperature while it is running, set a timer or to turn the oven off from the phone app while the  icon shows it is Wifi Connected.

After using the oven, remember to verify that the  icon is lit if you wish to start the oven remotely in the future.

NOTE: Foods that spoil easily—such as milk, eggs, fish, stuffings, poultry and pork—should not be allowed to sit for more than 1 hour before or after cooking. Room temperature promotes the growth of harmful bacteria. Be sure that the oven light is off because heat from the bulb will speed harmful bacteria growth.

Clock

This setting sets the oven clock time. Press the **Settings** pad and select **Clock**. Select **Set Clock** and follow the instructions to set the clock. This feature also specifies how the time of day will be displayed. You can select a standard 12-hour clock (12H), 24-hour military time display (24H), or no clock displayed (Off). Press the **Settings** pad, select **Set Clock** and select either **12/24 hr** or **On/Off**.

Bluetooth® - Chef Connect

This is a pairing feature for use with other compatible **Chef Connect** enabled products like an over-the-range microwave oven or range hood. To pair those products to the range Press the **Settings** pad and select **Bluetooth®**. Select **Pair** and follow the corresponding instructions included with the mating Chef Connect enabled product. The range will cancel pairing mode after two minutes if no mating device is detected. Select **Remove** to confirm product is paired or to un-pair from range. The Precision Cooking Probe can also be paired using the Bluetooth® feature.

Auto Conv (Auto Conversion)

When using Convection Bake and Convection Roast cooking, Auto Recipe Conversion will automatically convert the regular baking temperatures entered to convection bake cooking temperatures when turned on. Note that this option does not convert convection bake cooking times, it only converts temperatures. This feature may be turned On or Off. Select **Settings**, Auto Conversion is 5th option and shows up on first display of settings, and **Auto Conversion** then follow the prompts to turn this feature on or off.

Auto Off

This feature shuts the oven down after 12 hours of continuous operation. It may be enabled or disabled. Select **Settings**, **More**, and **Auto Off** to turn this feature on or off.

Sound

You can adjust the volume and type of alert your appliance uses. Select **Settings**, **More**, and **Sound**. Follow prompts for making volume adjustments or for changing between continuous and single alert tones. A continuous setting will continue to sound a tone until a button on the control is pressed. The oven tone volume can be adjusted. The control will sound the oven tone at the new volume level each time the sound level is changed.

F/C (Fahrenheit or Celsius)

The oven control is set to use Fahrenheit temperatures (F), but you can change it to use Celsius temperatures (C). Select **Settings**, **More**, and **F/C** to alter between temperature scales displayed.

Adjust the Oven temperature

This feature allows the oven baking and convection baking temperature to be adjusted up to 35°F (20°C) hotter or down to 35°F (20°C) cooler. Use this feature if you believe your oven temperature is too hot or too cold and wish to change it. This adjustment affects Bake and Convection Bake modes. Does not change Proof or Cleaning modes. Select **Settings** and **Oven Adjust** to add **More Heat** or **Less Heat** and then press **Save**.

Oven Info

Select **Settings**, **More**, and **Oven Info** to turn this feature on or off. This setting displays Model Number and Software Version.

Sabbath Mode

The Sabbath mode feature complies with standards set forth by Star K. Some of these standards that will be noticed by the consumer include the disabling of tones, disabling of oven lights, and delays of about 30 seconds to one minute on display changes. Only continuous baking or timed baking is allowed in the Sabbath mode. Cooking in the Sabbath mode is a two-step process, first the Sabbath mode must be set and then the bake mode must be set.

Setting the Sabbath Mode

Press the **Settings** pad, select **Sabbath**, and select **Turn on**. A single bracket “[” will appear in the display indicating that the Sabbath mode is set. The clock will not be displayed. Continuous bake or timed bake can now be programmed.

Starting a Continuous Bake

1. Press the **Bake** pad. (For double ovens, this operates the upper oven. If desiring to use Lower Oven, press **Lower Oven** and then **Bake**.)
2. If the desired temperature is 350°F (176.7°C), press **Start/Enter**. If a different cooking temperature is desired, use the **1** through **5** number pads to select a preset cooking temperature, then press **Start/Enter**. Refer to the graphic below to determine which pad sets the desired cooking temperature.

After a delay, a second bracket “[” will appear in the display indicating that the oven is baking.

Temperature (°F)	1	2	3
	200	250	300
Time (hours)	4	5	6
	325	400	2h
	7	8	9
	2.5h	3h	3.5h
	Cancel Off	0	Start Enter
		Lock Controls Hold 3 Sec 4h	

1 = 200°F/93.3°C, 2 = 250°F/121°C, 3 = 300°F/148.9°C,
4 = 325°F/162.8°C, 5 = 400°F/204.4°C

6 = 2 hours, 7 = 2.5 hours, 8 = 3 hours, 9 = 3.5 hours, 0 = 4 hours

Adjusting the Temperature

1. Press **Bake** (or press **Lower Oven** and then **Bake** for lower oven in a double oven unit), use the **1** through **5** number pads to select a different preset cooking temperature, and press **Start/Enter**.
2. Since no feedback is given during temperature change, an oven thermometer can be used to confirm temperature changes.

Starting a Timed Bake

1. Press the **Bake** pad.
2. If the desired temperature is 350°F (176.7°C), use the **6** through **0** number pads to select a cooking time. If a cooking temperature other than 350°F (176.7°C) is desired, use the **1** through **5** number pads to select a preset cooking temperature, then select the cooking time. Refer to the graphic on this page to determine which pad sets the desired cooking temperature and cooking time.
3. Press **Start/Enter**.

After a delay, a second bracket “[” will appear in the display indicating that the oven is baking. When the cook time expires, the display will change back to a single bracket “[” indicating that the oven is no longer baking. No tone will sound when the cook time is complete.

Exit the Sabbath Mode

Exiting the Sabbath mode should be done after the Sabbath is over.

1. Press **Cancel/Off** to end any bake mode that may be running.
2. Press and hold **Settings** pad until **Sabbath Mode off** is displayed.

Sabbath Mode Power Outage Note

If a power outage occurs while the oven is in Sabbath Mode, the unit will return to Sabbath Mode when power is restored, however the oven will return to the off state even if it was in the middle of a bake cycle when the power outage occurred.

Oven Racks

Rack Positions

Your oven has two rack positions in the upper oven (A, B) and four rack positions in the lower oven (R, 1, 2, 3). Recommended rack positions for various types of foods are provided in the Cooking Guide. Adjusting rack position is one way to impact cooking results. For example, if you would prefer darker tops on cakes, muffins, or cookies, try moving food one rack position higher. If you find foods are too brown on top try moving them down next time.

When baking with multiple pans and on multiple racks, ensure there is sufficient space between pans to allow air to flow. This may improve cooking evenness.

Removing and Replacing Flat Racks

When placing and removing cookware, pull the rack out to the bump (stop position) on the rack support.

To remove a rack, pull it toward you until it reaches the stop position, tilt up the front of the rack and pull it out.

To replace a rack, place the curved end of the rack onto the rack supports. Tilt up the front of the rack and push the rack in until it stops. Then lay the rack flat and push it in until it is all the way into the oven.

Racks may become difficult to slide, especially after a self-clean cycle. To improve sliding conditions, use a soft cloth or paper towel to rub vegetable oil on the left and right edges of the racks and/or rack supports.

NOTE: Remove unused racks when using the oven for faster preheat, improved efficiency, and optimal cooking performance.

Extension Racks (on some models)

Extension racks have a frame that locks into the rack supports on both sides. Once the frame is locked into place, always use the upper front rail to pull the rack out to its full extension position when placing or removing cookware.

If extension racks are difficult to extend, lubricate the racks with the graphite lubricant provided with your oven. Remove the rack from the oven (see Extension Rack Removal), remove debris in the slide tracks with a paper towel, shake the graphite lubricant, and place 4 small drops on the two bottom tracks of the left and right sides. Open and close the rack several times to distribute the lubricant.

See the Accessories section for instructions on ordering additional racks and graphite lubricant.

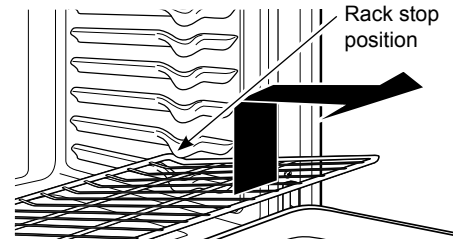
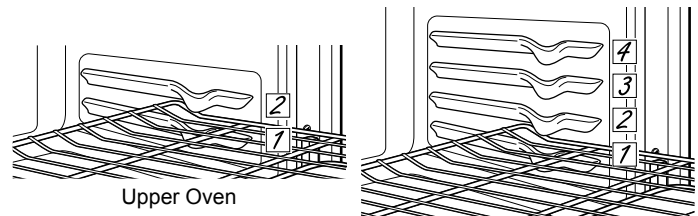

Removing racks

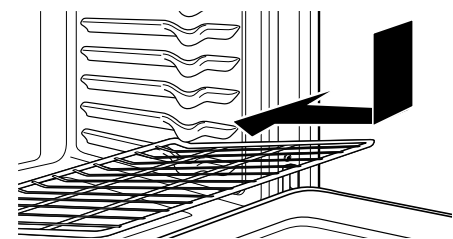

Replacing racks

Extension Rack Removal

1. Make sure the rack is pushed all the way into the oven.
2. Firmly holding onto both the upper and lower front rails, pull the rack toward you, tilt the front end up and pull the rack out.

Extension Rack Replacement

1. Place the curved end of the rack onto the rack supports.
2. Tilt up the front of the rack and push the rack in until it stops.
3. Lay the rack flat and push it in until it is all the way into the oven.

If extension racks are difficult to replace or remove, wipe the oven rack supports with cooking oil. Do not wipe oil on the rack slides.

Aluminum Foil and Oven Liners

▲ CAUTION

Do not use any type of foil or oven liner to cover the oven bottom. These items can trap heat or melt, resulting in damage to the product and risk of shock, smoke or fire. Damage from improper use of these items is not covered by the product warranty.

Foil may be used to catch spills by placing a sheet on a lower rack, several inches below the food. Do not use more foil than necessary and never entirely cover an oven rack with aluminum foil. Keep foil at least 1-1/2" (3.8 cm) from oven walls to prevent poor heat circulation.

Cookware

Cookware Guidelines

The material, finish, and size of cookware affect baking performance.

Dark, coated and dull pans absorb heat more readily than light, shiny pans. Pans that absorb heat more readily can result in a browner, crisper, and thicker crust. If using dark and coated cookware check food earlier than minimum cook time. If undesirable results are obtained with this type of cookware consider reducing oven temperature by 25°F (14°C) next time.

Shiny pans can produce more evenly cooked baked goods such as cakes and cookies.

Glass and ceramic pans heat slowly but retain heat well. These types of pans work well for dishes such as pies and custards.

Air insulated pans heat slowly and can reduce bottom browning.

Keep cookware clean to promote even heating.

Stoneware heats slowly and retains heat well. It is recommended to preheat this type of cookware if possible. Additional cook time may be required.

Cooking Modes

Your new oven has a variety of cooking modes to help you get the best results. These modes are described below. Refer to the Cooking Guide section for rack position and other recommendations for specific modes and foods.

Bake

The bake mode is for baking and roasting. When preparing baked goods such as cakes, cookies and pastries, always preheat the oven first. To use this mode press the **Bake** pad, enter a temperature with the number pads, and then press **Start/Enter**.

Warm

Warm mode is designed to keep hot foods hot. Cover foods that need to remain moist and do not cover foods that should be crisp. Preheating is not required. Do not use warm to heat cold food. It is recommended that food not be kept warm for more than 2 hours. Press the **Warm** pad and then press **Start/Enter**.

Some models may also have warming drawers. Three settings are available - use High for items such as stews, meats, and potatoes; use Medium for items such as casseroles and pizzas; use Low for items such as breads, waffles, and also for warming oven-safe dishes.

Broiling Modes

Always broil with the oven door/drawer closed. Monitor food closely while broiling. Use caution when broiling; placing food close to the broil element or burner increases smoking, spattering and the possibility of fats igniting. It is not necessary to preheat when using the Broil modes.

Broil Hi

The Broil High mode uses intense heat from the upper element or burner to sear foods. Use Broil High for thinner cuts of meat and/or when you would like to have a seared surface and rare interior. To use this mode press the **Broil** pad once and then press **Start/Enter**.

Broil Lo

The Broil Low mode uses less intense heat from the upper element or burner to cook food thoroughly while also browning the surface. Use Broil Low for thicker cuts of meat and/or foods that you would like cooked all the way through. To use this mode press the **Broil** pad twice and then press **Start/Enter**.

Cooking Modes (Cont.)

Frozen Snacks

The Frozen Snacks modes are designed to cook frozen foods such as potato nuggets, French fries, and similar frozen snacks and appetizers. Most foods will cook within package recommended time. Adjust cooking time according to individual preferences. Press **Options** and select **Frozen** then follow any display prompts to access this mode.

Use Frozen Snacks Single when cooking frozen snacks on a single rack. This mode does not require preheating the oven. Food should be placed in the oven before or immediately upon starting this mode.

Use Frozen Snacks Multi when cooking frozen snacks on two racks simultaneously. This mode includes a preheating cycle to prepare the oven for multi-rack baking.

Frozen Pizza

The Frozen Pizza modes are designed to cook frozen pizzas. Most pizzas will cook within package recommended times. Adjust cooking time according to individual preferences. Press **Options** and select **Frozen** then follow any display prompts to access this mode.

Use Frozen Pizza Single when cooking on a single rack. This mode does not require preheating the oven. Food should be placed in the oven before or immediately upon starting this mode.

Use Frozen Pizza Multi when cooking on two racks simultaneously. This mode includes a preheating cycle to prepare the oven for multi-rack baking.

Baked Goods

The Baked Goods mode is designed for cooking cakes, breads, cookies, and similar foods on a single rack. This mode is designed to provide lighter top browning and better volume. Some foods may require slightly longer cook times relative to when cooked in the traditional bake mode. Press **Options** and select **Baked Goods** then follow any display prompts to access this mode.

Convection Bake Multi Rack

The Convection Bake mode is intended for baking on multiple racks at the same time. This mode uses air movement from the convection fan to enhance cooking evenness. Your oven is equipped with Auto Recipe Conversion, so it is not necessary to adjust the temperature when using this mode. Always preheat when using this mode. Baking times may be slightly longer for multiple racks than what would be expected for a single rack. To use this mode press the **Conv Bake** pad, enter a temperature with number pads, and then press **Start/Enter**.

Convection Roast

The Convection Roast mode is intended for roasting whole cuts of meat on a single rack. This mode uses air movement from the convection fan to improve browning and reduce cooking time. Check food earlier than the recipe suggested time when using this mode, or use the probe (see the Probe section for more information). It is not necessary to preheat when using this mode. To use this mode press the **Conv Roast** pad, enter a temperature with the number pads, and then press **Start/Enter**.

Proof

Proof mode maintains a warm environment for rising yeast-leavened dough. If the oven is too warm, Proof mode will not operate and the display will show "Oven too hot for Proof". For best results, cover the dough while proofing and check early to avoid over-proofing. Press **Options** and select **Proof** then follow any display prompts or press the **Proof** pad (on some models) to access this mode.

CAUTION Do not use the Proof mode for warming food or keeping food hot. The proofing oven temperature is not hot enough to hold foods at safe temperatures.

Oven Air Vents

Never block the vents (air openings) of the range. They provide the air inlet and outlet that are necessary for the range to keep cool and operate properly with correct combustion.

Air openings are located at the rear of the cooktop, at the top and bottom of the oven door, and at the bottom of the range.

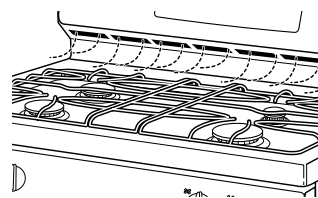

Vent appearance and location vary.

Oven Probe

▲WARNING Consuming undercooked food can result in foodborne illness. Use probe according to the following instructions to ensure all portions of the food reach minimum safe cooking temperatures. Recommendations for minimum safe food temperatures can be found at www.foodsafety.gov or www.IsItDoneYet.gov.

Internal food temperature is frequently used as an indicator of doneness, especially for roasts and poultry. The Probe mode monitors the internal food temperature and turns the oven off when the internal food temperature reaches the programmed temperature.

Always check the temperature at multiple locations in the food with a food thermometer after cooking to ensure that all portions of the food have reached the minimum safe internal temperature for that food.

Proper Probe Placement

After preparing the meat and placing it on the cooking pan follow these instructions for proper probe placement.

- Insert the probe into the food, so that the tip of the probe will rest in the center of the thickest part of the food. For best performance the probe should be fully inserted into the food. If the probe is not located properly, it may not accurately measure the temperature of the coolest portion of the food. Some foods, particularly small items, are not well suited for cooking with the probe due to their shape or size.
- The probe should not touch bone, fat or gristle.
- For whole poultry insert the probe into the thickest part of the breast.
- For boneless roasts, insert the probe into the center of the roast.
- For bone-in ham or lamb, insert the probe into the center of the lowest large muscle or joint.
- For casseroles or dishes such as meatloaf, insert the probe into the center of the dish.
- For fish, insert the probe from just above the gill into the meatiest area, parallel to the backbone.

Probe Usage

The temperature probe can only be used with Bake, Convection Bake, and Convection Roast.

To use the probe with preheating:

1. Select the desired cook mode (**Bake**, **Convection Bake**, or **Convection Roast**) pad and enter the desired cooking temperature with the number pads.
2. Insert the probe into the food (see Proper Probe Placement).

3. Once the oven is preheated, place the food in the oven and connect the probe to the probe outlet, making sure it is fully inserted. Use caution, the oven walls and probe outlet are hot.
4. When the probe is connected, the display will prompt you to enter the desired food temperature. The maximum internal food temperature that you can set is 200°F (93.3°C).

To use the probe without preheating:

1. Insert the probe into the food (see Proper Probe Placement).
2. Place the food in the oven and connect the probe into the probe outlet in the oven.
3. Press the **Cook Mode** pad (**Traditional Bake**, **Convection Bake**, or **Convection Roast**) and enter the desired cooking temperature with the number pads. Press **Options** and select **Probe** then follow the display prompts to enter the desired food temperature.

Probe Care Guidelines

- Use of probes other than the one provided with this product may result in damage to the probe outlet.
- Use the handles of the probe and plug when inserting and removing them from the meat and outlet
- To avoid damaging your probe, do not use tongs to pull on the cable when removing it.
- To avoid breaking the probe, make sure food is completely defrosted before inserting the probe.
- To prevent possible burns, do not unplug the probe from the outlet until the oven has cooled.
- Never leave the probe inside the oven during a self or steam clean cycle.
- Do not store the probe in the oven.

Cooking Guide

FOOD TYPE	RECOMMENDED MODE(S)	OVEN (Upper/Lower)	RECOMMENDED RACK POSITION(S)	ADDITIONAL SUGGESTIONS
Baked Goods				
Layer cakes, sheet cakes, bundt cakes, muffins, quick breads on a Single Rack	Bake	Upper Lower	2 3	Use shiny cookware.
	Bake Goods	Upper Lower	2 3	
Layer cakes* on Multiple Racks	Bake Convection Bake	Lower	2 and 4	Ensure adequate airflow (see illustration below).
Chiffon cakes (angel food)	Bake Goods	Lower	1	Use shiny cookware.
Cookies, biscuits, scones on a Single Rack	Bake	Upper Lower	2 3	Use shiny cookware.
	Bake Goods	Upper Lower	2 3	
Cookies, biscuits, scones on Multiple Racks	Convection Bake	Lower	1 and 3	Ensure adequate airflow.
Yeast Breads	Proof	Lower	2	Cover dough loosely.
	Bake	Upper Lower	1 2	
	Bake Goods	Upper Lower	1 2	
Beef & Pork				
Hamburgers	Broil High	Lower	4	Use a broil pan; move food down for more doneness/less searing. Watch food closely when broiling. For best performance center food below the broiler element or burner.
Steaks & Chops	Broil High	Lower	3 or 4	Use a broil pan; move food down for more doneness/less searing. Watch food closely when broiling. For best performance center food below the broiler element or burner.
Roasts	Bake Convection Roast	Lower	2	Use a low sided pan such as a broil pan. Preheating is not necessary.
Poultry				
Whole chicken	Bake Convection Roast	Lower	2	Use a low sided pan such as a broil pan.
Bone-in chicken breasts, legs, thighs	Broil Low Bake	Lower	2	If breaded or coated in sauce avoid Broil High modes. Broil skin side down first. Watch food closely when broiling. For best performance when broiling, center food below the broil heater or burner.
Boneless chicken breasts	Broil Low Bake	Lower	2	Move food down for more doneness/less searing and up for greater searing/browning when broiling. For best performance when broiling, center food below the broil element or burner.
Whole turkey	Bake Convection Roast	Lower	1	Use a low sided pan such as a broil pan.
Turkey Breast	Bake Convection Roast	Lower	2	Use a low sided pan such as a broil pan.
Fish	Broil Low	Lower	4 (1/2 inch/1.3 cm thick or less) 3 (>1/2 inch/1.3 cm)	Watch food closely when broiling. For best performance center food below the broil heating element.
Casseroles	Bake	Upper Lower	2 2 or 3	
Frozen Convenience Foods				
Pizza on a Single Rack	Frozen Pizza Single	Upper Lower	2 3	Do not preheat.
Pizza on Multiple Racks	Frozen Pizza Multi	Lower	2 and 4	Stagger pizzas left to right, do not place directly over each other.
Potato products, chicken nuggets, appetizers on a Single Rack	Frozen Snacks Single	Upper Lower	2 3	Do not preheat. Use dark cookware for more browning/crisping; use shiny cookware for less browning.
Potato products, chicken nuggets, appetizers on Multiple Racks	Frozen Snacks Multi	Lower	2 and 4	Use dark cookware for more browning/crisping; use shiny cookware for less browning.

*When baking four cake layers at a time use racks 2 and 4. Place the pans as shown so that one pan is not directly above another.

Cook food thoroughly to help protect against food borne illness. Minimum safe food temperature recommendations for food safety can be found at www.IsItDoneYet.gov. Make sure to use a food thermometer to take food temperatures.

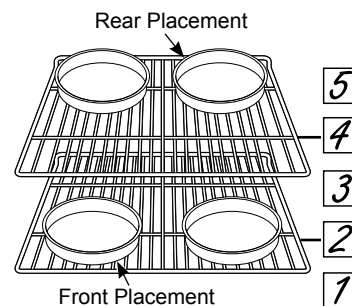

Range – Exterior

Be sure all controls are off and all surfaces are cool before cleaning any part of the range.



▲ WARNING

If your range is removed for cleaning, servicing or any reason, be sure the anti-tip device is reengaged properly when the range is replaced. Failure to take this precaution could result in tipping of the range and can result in death or serious burns to children or adults.

Control Lockout

If desired, the touch pads may be deactivated before cleaning.

See Lock Controls in the Oven Controls section in this manual.

Clean up splatters with a damp cloth.

You may also use a glass cleaner.

Remove heavier soil with warm, soapy water. Do not use abrasives of any kind.

Reactivate the touch pads after cleaning.

Control Panel

It's a good idea to wipe the control panel after each use. Clean with mild soap and water or vinegar and water, rinse with clean water and polish dry with a soft cloth.

Do not use abrasive cleansers, strong liquid cleansers, plastic scouring pads or oven cleaners on the control panel—they will damage the finish, including Black Stainless Steel.

Oven Exterior

Do not use oven cleaners, abrasive cleansers, strong liquid cleansers, steel wool, plastic scouring pads, or cleaning powders on the interior or exterior of the oven. Clean with a mild soap and water or vinegar and water solution. Rinse with clean water and dry with a soft cloth. When cleaning surfaces, make sure that they are at room temperature and not in direct sunlight.

If stain on the door vent trim is persistent, use a mild abrasive cleaner and a sponge-scrubber for best results.

Spillage of marinades, fruit juices, tomato sauces and basting liquids containing acids may cause discoloration and should be wiped up immediately. Let hot surfaces cool, then clean and rinse.

Painted Surfaces

Painted surfaces include the sides of the range and the door, top of control panel and the drawer front. Clean these with soap and water or a vinegar and water solution.

Do not use commercial oven cleaners, cleaning powders, steel wool or harsh abrasives on any painted surface, including Black Stainless Steel.

Stainless Steel excluding Black Stainless Steel (on some models)

Do not use a steel wool pad; it will scratch the surface.

Cleaners with oxalic acid such as Bar Keepers Friend Soft Cleanser™ will remove surface rust, tarnish and small blemishes. Use only a liquid cleanser free of grit and rub in the direction of the brush lines with a damp, soft sponge.

To clean the stainless steel surface, use warm sudsy water or a stainless steel cleaner or polish. Always wipe the surface in the direction of the grain. Follow the cleaner instructions for cleaning the stainless steel surface.

To inquire about purchasing cleaning products including stainless steel appliance cleaner or polish, see the Accessories and Consumer Support sections at the end of this manual.

Range – Interior

The interior of your new oven can be cleaned manually or by using Steam Clean or Self Clean modes. Spillage of marinades, fruit juices, tomato sauces and basting liquids containing acids may cause discoloration and should be wiped up immediately. Let hot surfaces cool, then clean and rinse.

Manual Cleaning

Do not use oven cleaners, strong liquid cleansers, steel wool, or scouring pads on the interior of the oven. For soils on the oven bottom and other enameled surfaces, use a gentle abrasive containing oxalic acid, such as Bar Keepers Friend®, with a non-scratch sponge. Take care not to apply any abrasive cleaners or sponges to

the door glass, as it will scratch the reflective coating. The oven interior and door glass may be cleaned using a soft cloth with a mild soap and water, or vinegar and water solution. After cleaning, rinse with clean water and dry with a soft cloth.

Steam Clean Mode

The Steam Clean feature is for cleaning light soil from your oven at a lower temperature than Self Clean.

To use the Steam Clean feature:

1. Start with the oven at room temperature.
2. Wipe excess grease and soils from the oven.
3. Pour one cup of water onto the bottom of the oven.
4. Close the door.
5. Press the **Clean** pad, select **Steam Clean** and then press **Start/Enter**.

You cannot open the door during the 30 minute Steam Clean cycle. At the end of the Steam Clean cycle, soak up the remaining water, and wipe the moisture-softened soil from the oven walls and door.

Self Clean Mode

Read Self-Cleaning Oven Safety Instructions at the beginning of this manual before using the Self Clean Mode. Self Clean uses very high temperatures to clean the oven interior. For a moderately soiled oven, run a 3 hour self-clean cycle. For a heavily soiled oven, run a 5 hour self-clean cycle. Only self-clean (black) racks and grates may remain in the oven during the self-clean cycle. All other items, including nickel plated (silver) racks, should be removed. If nickel plated (silver) racks are left in the oven during a self-clean cycle, the racks will tarnish. If either type of rack is left in the oven during a self-clean cycle, the rack may become difficult to slide. See the Oven Racks section for instructions on how to improve.

IMPORTANT: The health of some birds is extremely sensitive to the fumes given off during the self-cleaning cycle of any range. Move birds to another well-ventilated room.

To use the Self Clean feature:

1. Start with the oven at room temperature.
2. Wipe excess grease and soils from the oven and interior door.
3. Remove all items other than self-clean (black) racks and grates, if desired. See Cleaning the Cooktop to determine if your grates may be self-cleaned and for important details regarding grate placement.
4. Close the door.
5. Press the **Clean** pad, select **Self Clean** and then press **Start/Enter**.

You cannot open the door during the self-clean cycle. The door will remain locked after the self-clean cycle until the oven cools below the unlocking temperature. At the end of the self-clean cycle, allow the oven to cool and wipe any ash out of the oven.

Racks

All racks can be washed with warm, soapy water. Enameled (not shiny) racks can be left in the cavity during self clean.

Racks may be more difficult to slide, especially after a self-clean. Put some vegetable oil on a soft cloth or paper towel and rub onto the left and right edges.

Cooktop

Removal of Surface Burners for Cleaning

Turn all controls OFF. Allow cooktop to cool before removing grates and burner parts. When removing the burner caps and heads, remember their size and location. Replace them in the same location after cleaning.

CAUTION Do not attempt to remove oval or dual oval burner caps from the burner heads.

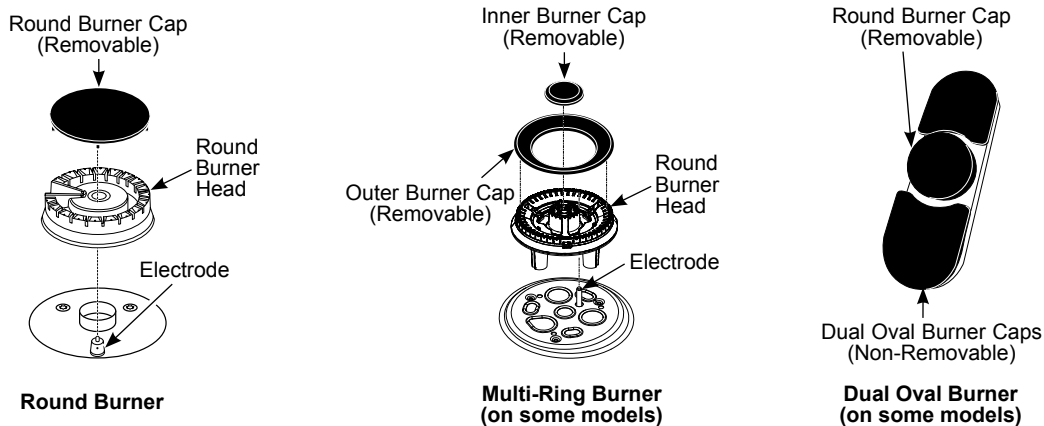

Cleaning the Surface Burners

Cleaning the Burner Caps

Wash burner caps in hot, soapy water and rinse with clean water. You may scour with a plastic scouring pad to remove burned-on food particles. The round burner caps may also be cleaned in your dishwasher.

Cleaning the Burner Heads

Wash the burner heads routinely, especially after bad spills which could clog the burner openings. Lift burners off when cool. Wash with hot, soapy water. Rinse with clean water. For more stubborn stains, use a brush with plastic bristles.

NOTE: Do not use steel wool or scouring pads to clean the burner parts as these may clog the openings. Never wash burner heads in your dishwasher as dishwasher. Doing so may cause them to discolor.

The ports in the burner heads must be kept clean at all times for an even, unhampered flame.

Clogged or dirty burner ports or electrodes will not allow the burner to operate properly.

Replacing Surface Burners

Before replacing the burner caps, heads and oval head/cap assembly, shake out excess water and allow them to dry thoroughly.

Replace burner heads in the correct locations according to size. Ensure each cap is properly seated on the burner head, as pictured below.



Burner cap is NOT properly seated.



Burner cap is NOT properly seated.

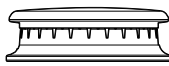

Burner cap is properly seated.

CAUTION Do not operate the cooktop without all burner parts and grates in place.

Any spill on or around an electrode must be carefully cleaned. Avoid hitting the electrode with anything hard or it could be damaged.

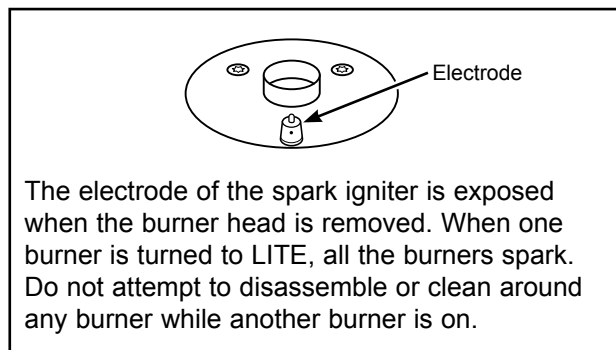

Cooktop (Cont.)

Burner Grates

Manual Cleaning

Grates should be washed in hot, soapy water and rinsed with clean water. To soften burned-on food, place grates in a solution containing ¼-cup of household ammonia for several hours. Afterward, scrub grates with a plastic scouring pad soaked in hot, soapy water. Rinse well and dry.

Self Clean Mode (on some models)

If your grates do not have rubber bumpers on their bottom surface, they may be cleaned in the oven using the self-clean cycle. Do not attempt to clean your grates in the oven if your grates have rubber bumpers. Doing so will destroy the rubber bumpers and may affect the function of your surface burners.

Porcelain-coated grates may gradually dull if continually exposed to self-clean temperatures.

If your oven is equipped with self-clean (black) racks, it is recommended to follow the instructions for placing grates on racks. If your oven is equipped with nickel-plated (silver) racks, it is recommended to follow the instructions for placing grates on the oven bottom. Nickel-plated racks should not remain in the oven during the self clean cycle. Doing so will tarnish the racks. If either type of rack is left in the oven during a self-clean cycle, the rack may become difficult to slide.

NOTE: When placing or removing grates from the oven, do not slide the grates on the racks or oven bottom. Doing so could damage the enamel on the racks or oven bottom.

To self-clean your grates on self-clean racks: (Lower Oven Only):

1. Insert racks in positions 1, 3, and 5 or positions 2 and 4.
2. Gently place one grate on each rack.

To self clean your grates on the oven bottom (Lower Oven Only):

1. Remove all oven racks.
2. Gently place one grate on the center of the oven bottom with the grate oriented in the upright position. Stack remaining grate(s) as shown below. Do not place or stack grates in any other configuration.

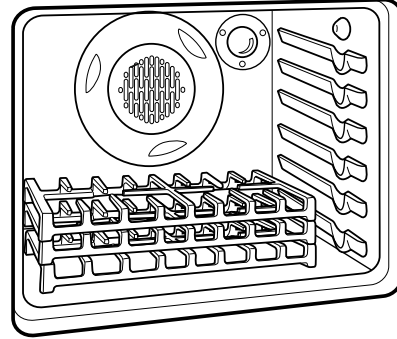

Once the grates are placed in the oven, operate the self-clean cycle per the instruction in the CARE AND CLEANING: Range – Interior.

NOTE: Use caution when removing the grates from the oven after the self-clean cycle has ended. The grates may still be hot.

Once the self-clean cycle is complete, the grates may carefully be removed. You may notice a white residue on the grates. Wipe it off with a damp sponge. If white spots persist, wet the sponge with a 50/50 solution of vinegar and water and wipe the grates again.

When replacing the grates on the cooktop, be sure to locate them correctly. Grates should fit securely into the cooktop.

Grate Support Bumpers (on some models)

If any of the rubber grate support bumpers in the cooktop are missing or damaged, replacement parts can be obtained by calling 1.800.561.3344.

To insert the new bumpers, simply place the cone-shaped end of the bumper into the hole in the cooktop and push down while gently twisting the bumper.

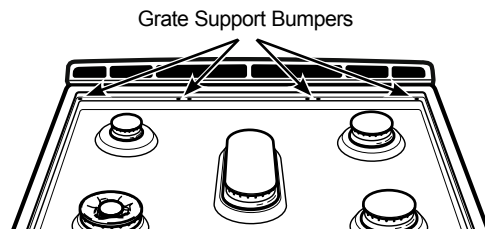

Griddles (on some models)

Cast Iron and Reversible Cast-Iron: Clean your reversible cast-iron griddle with a stiff brush and hot water. Using soap is not recommended, and harsh detergents should never be used as they will remove the seasoning. Rinse with hot water and dry thoroughly. After rinsing, pre-season the griddle by applying a light coat of cooking oil to the griddle surface. Wipe off excess oil with a paper towel.

Store in a cool, dry place.

Griddle Precautions:

- If something has spilled under the griddle, it should be cleaned up as soon as possible to prevent the spill from getting baked onto the cooktop.
- Do not allow grease to accumulate under the griddle as it can be a fire hazard. Clean under the griddle with hot, soapy water as soon as it is cool.
- Do not wash your griddle in the dishwasher.
- Do not clean the griddle in the self-cleaning oven.

Door

Cleaning the Oven Door

Cleaning the Door Interior

Do not allow excess water to run into any holes or slots in the door.

Wipe dish soap over any baked-on spatters on the glass. Use a single sided safety razor blade to clean it off. Then wipe over the glass with a soapy cloth to remove any residue and dry off.

The area outside the gasket can be cleaned with a soap-filled plastic scouring pad. Do not rub or clean the door gasket - it has an extremely low resistance to abrasion.

If you notice the gasket becoming worn, frayed or damaged in any way or if it has become displaced on the door, you should have it replaced.

Cleaning the Door Exterior

If a stain on the door vent trim is persistent, use a mild abrasive cleaner and a sponge-scrubber for best results. Do not use this method on any other surface.

Stainless Steel Surfaces (on some models)

Do not use a steel wool pad; it will scratch the surface.

To clean the stainless steel surface, use warm sudsy water or a stainless steel cleaner or polish. Always wipe the surface in the direction of the grain. Follow the cleaner instructions for cleaning the stainless steel surface.

To inquire about purchasing cleaning products including stainless steel appliance cleaner or polish, see the Accessories and Consumer Support sections at the end of this manual.

Oven Probe

The temperature probe may be cleaned with soap and water or a soap-filled scouring pad. Cool the temperature probe before cleaning. Scour stubborn spots with a soap-filled scouring pad, rinse and dry.

To order additional temperature probes, see the Accessories and Consumer Support sections at the end of this manual.

- Do not immerse the temperature probe in water.
- Do not store the temperature probe in the oven.
- Do not leave the temperature probe inside the oven during a self or steam clean cycle.

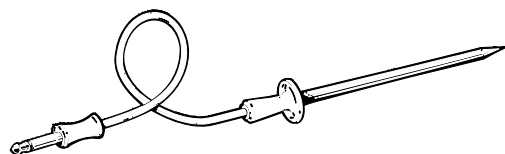

Oven Light

Oven Light Replacement

⚠ WARNING **SHOCK OR BURN HAZARD:** Before replacing oven light bulb, disconnect the electrical power to the oven at the main fuse or circuit breaker panel. Failure to do so may result in electric shock or burn.

⚠ CAUTION **BURN HAZARD:** The glass cover and bulb should be removed when cool. Touching hot glass with bare hands or a damp cloth can cause burns.

NOTE: The glass cover should be removed only when cold. Wearing latex gloves may offer a better grip. Before replacing the bulb, disconnect electrical power to the oven at the main fuse or circuit breaker panel. Let the bulb cool completely before removing it. For your safety do not touch a hot bulb with a damp cloth. If you do the bulb may break.

To remove:

Turn the glass cover counterclockwise 1/4 turn until the tabs of the glass cover clear the grooves of the socket and pull the cover off. Remove the bulb.

To replace:

Put in a new 40-watt appliance bulb. Place the tabs of the glass cover into the grooves of the socket. Turn the glass cover clockwise 1/4 turn.

NOTE:

- A 40-watt appliance bulb is smaller than a standard 40-watt household bulb.
- Reconnect electrical power to the oven once the new bulb is installed.
- For improved lighting inside the oven, clean the glass cover frequently using a wet cloth. This should be done when the oven is completely cool.

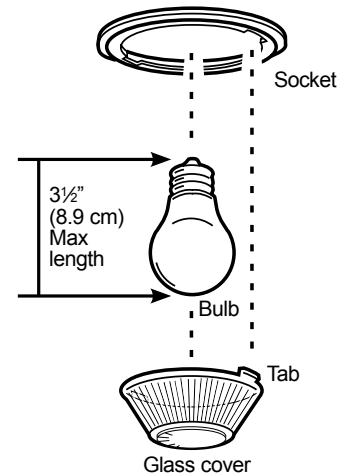

Oven Door

Lift-Off Oven Door

The door is very heavy. Be careful when removing and lifting the door. Do not lift door by the handle.

To Remove the Door:

1. Fully open the door.
2. Pull the hinge locks up and away from the range frame to the unlocked position.
3. Firmly grasp both sides of the door near the top.
4. Close door until the top of the door is approximately 6" (15.2 cm) from the range frame.
5. Lift door up and away from the range until both hinge arms are clear of the slots in the range frame.

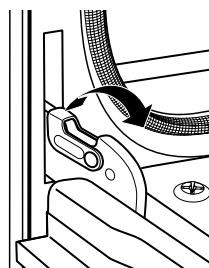

Pull hinge locks up to unlock

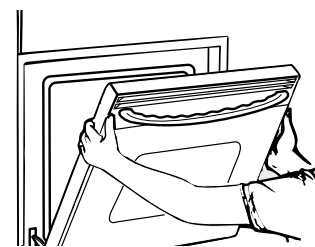

Removal position

To Replace the Door:

1. Firmly grasp both sides of the door near the top.
2. With the door at the same angle as the removal position, rest the notch on the underside of the left hinge arm on the bottom edge of the left hinge slot. The notch in the hinge arm must be fully seated into the bottom of the slot. Repeat for the right side.
3. Fully open the door. If the door will not fully open, the notches in the bottoms of the hinge arms have not seated correctly in the bottom edge of the slot. Lift the door off the range and repeat previous step.
4. Push the hinge locks toward the range cavity and down to the locked position.
5. Close the oven door.

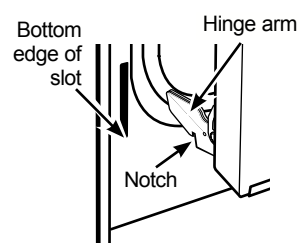

Rest notch on bottom edge of hinge slot

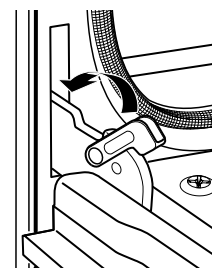

Push hinge locks down to lock

Lift-Off Upper Oven Door

The door is very heavy. Be careful when removing and lifting the door. Do not lift door by the handle.

To Remove the Door:

1. Fully open the door.
2. Lift up on the hinge lock toward the oven frame until they stop.
3. Close the door to 45 degrees (you will feel the door stop). The hinge lock will contact the oven frame.
4. On both sides of the door, press down on the release buttons on each hinge.
5. Lift door up until it is clear of the hinge.
6. Pull on hinge arms slightly to relieve pressure on the locking tabs.
7. Push the hinge locks down onto the hinge.
8. Push the hinges in toward the unit so they are closed.

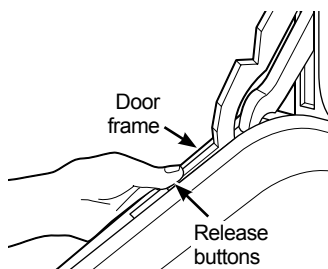
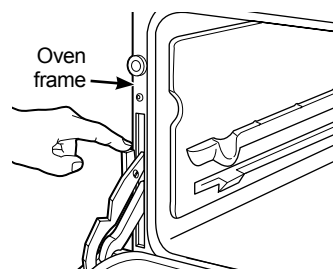

To Replace the Door:

1. Pull the hinges down away from the oven frame to the fully open position.
2. Lift up on the hinge locks toward the oven frame until they stop.
3. The hinges will release to the 45-degree position. The hinge locks will contact the oven frame.
4. Slide the door back onto the hinges. Make sure the buttons pop back out.
5. Fully open the door.
6. Push the hinge locks down onto the hinge.
7. Close the oven door.

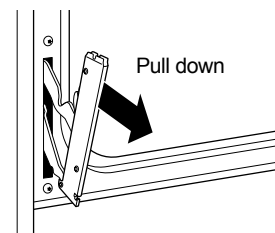
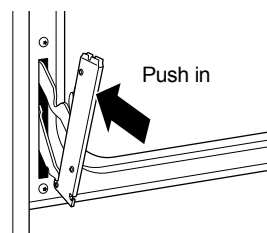

Troubleshooting Tips ... Before you call for service

Save time and money! Review the charts on the following pages first and you may not need to call for service.

Problem	Possible Cause	What To Do
My new oven doesn't cook like my old one. Is something wrong with the temperature settings?	Your new oven has a different cooking system from your old oven and therefore may cook differently than your old oven.	For the first few uses, follow your recipe times and temperatures carefully and use rack positions recommended in the Cooking Guide. If you still think your new oven is too hot or too cold, you can adjust the temperature yourself to meet your specific cooking preference. See the Settings section.
Food does not bake properly	Oven controls improperly set.	See the Cooking Modes section.
	Rack position is incorrect or rack is not level.	See the Cooking Modes section and Cooking Guide.
	Incorrect cookware or cookware of improper size being used.	See the Cookware section.
	Oven temperature needs adjustment.	See the Settings section.
Food does not broil properly	Oven controls improperly set.	Make sure you select the appropriate broil mode.
	Improper rack position being used.	See Cooking Guide for rack location suggestions.
	Cookware not suited for broiling.	Use a pan specifically designed for broiling.
	Aluminum foil on the broil pan has not been fitted properly or slit to drain grease.	If using aluminum foil on broil pan, wrap tightly and add slits conforming to those in the pan to allow grease to drain.
Oven temperature too hot or too cold	Oven temperature needs adjustment.	See the Cooking Modes section.
Oven and/or display appears not to work	A fuse in your home may be blown or the circuit breaker tripped.	Replace the fuse or reset the circuit breaker.
	Oven controls improperly set.	See the Settings section.
	Oven is in Sabbath Mode.	Verify, that the oven is not in Sabbath Mode. See the Sabbath Mode section.
	The clock is turned off.	See the Settings section.
"Crackling" or "popping" sound	This is the sound of the metal heating and cooling during both the cooking and cleaning functions.	This is normal.
Why is my range making a "clicking" noise when using my oven?	Your range has been designed to maintain a tighter control over your oven's temperature. You may hear your oven's heating elements "click" on and off more frequently than in older ovens to achieve better results during baking, broiling, and self-clean cycles.	This is normal.
Sometimes the oven takes longer to preheat to the same temperature	Cookware, food, and/or number of racks in oven.	Cookware, food, and racks in the oven will cause differences in preheat times. Remove excess items to reduce preheat time.

Troubleshooting Tips ... Before you call for service

Problem	Possible Cause	What To Do
Oven light does not work	Light bulb is loose or defective.	Tighten or replace bulb. See the Oven Light section for instructions on how to replace the bulb.
Oven will not self-clean	The temperature is too high to set a self-clean operation.	Allow the oven to cool and reset the controls.
	Oven controls improperly set.	See the CARE AND CLEANING: Range – Interior section.
Excessive smoking during clean cycle	Excessive soil or grease.	Press the Cancel/Off pad. Open the windows to rid the room of smoke. Wait until the LOCKED light goes off. Wipe up the excess soil and reset the clean cycle.
Oven not clean after a clean cycle	Oven controls improperly set.	See the CARE AND CLEANING: Range – Interior section.
	Oven was heavily soiled.	Clean up heavy spillovers before starting the clean cycle. Heavily soiled ovens may need to self-clean again or for a longer period of time.
Strong “burning” or “oily” odor emitting from the vent	This is normal in a new oven and will disappear in time.	To speed the process, set a self-clean cycle for a minimum of 3 hours. See the CARE AND CLEANING: Range – Interior section. This is temporary.
Excessive smoking during broiling	Food too close to burner element.	Lower the rack position of the food.
Oven door will not open or LOCKED light is on when you want to cook.	The oven door is locked because the temperature inside the oven has not dropped below the locking temperature.	Press the Cancel/Off pad. Allow the oven to cool below the locking temperature.
“LOCK DOOR” flashes in the display	The self-clean cycle has been selected but the door is not closed.	Close the oven door.
“F— and a number or letter” flash in the display	You have a function error code.	Press the Cancel/Off pad. Allow the oven to cool for one hour. Put the oven back into operation. If the function code repeats, disconnect all power to the oven for at least 30 seconds and then reconnect power. If the function error code repeats again, call for service.
Power outage, clock flashes	Power outage or surge	Reset the clock. If the oven was in use, you must reset it by pressing the Cancel/Off pad, setting the clock and resetting any cooking function.
Lock Controls or Control Lockout feature is activated		If LOC ON appears in the display, the range control is locked. Turn this feature off to use the range. See the Lock Control feature in the Oven Controls section.
Burners do not light	Plug on range is not completely inserted in the electrical outlet.	Make sure electrical plug is plugged into a live, properly grounded outlet.
	Gas supply not connected or turned on.	See the Installation Instructions that came with your range.
	A fuse in your home may be blown or the circuit breaker tripped.	Replace the fuse or reset the circuit breaker.
	Burner parts not replaced correctly.	See the Care and Cleaning of the range section.
	Burner slots near the electrode, or the round lighter port on the oval burner, may be clogged.	Remove the burners and clean them. Check the electrode area for burned-on food or grease. See the Care and Cleaning of the range section.
	Food residue on electrode	Lightly polish flat tip of electrode with nail file or sandpaper until shiny.

Troubleshooting Tips ... Before you call for service

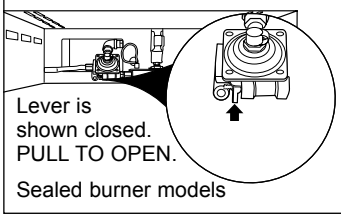
Problem	Possible Cause	What To Do
Top burners do not burn evenly	Improper burner assembly.	Make sure the burner caps are seated correctly. See the Care and Cleaning of the range section.
	Burner slots on the side of the burner may be clogged.	Remove the burners for cleaning. See the Care and Cleaning of the range section.
Burner flames are very large or yellow	Improper air to gas ratio.	If range is connected to Propane gas, contact the technician who installed your range or made the conversion.
Surface burners light but bake and broil burners do not.	Gas to the oven burners may have been shut off.	<p>The oven gas shut-off is located on the gas regulator near the gas line attachment to your range. Locate it and flip the lever.</p>  <p>Lever is shown closed. PULL TO OPEN.</p> <p>Sealed burner models</p>
My oven door glass appears to be "tinted" or have a "rainbow" color.	The inner oven glass is coated with a heat barrier to reflect the heat back into the oven to prevent heat loss and keep the outer door cool while baking.	This is normal. Under certain light or angles, you may see this tint or rainbow color.
Drawer does not slide smoothly or drags	The drawer is out of alignment.	Fully extend the drawer and push it all the way in. See the Care and Cleaning of the range section.
	Drawer is over-loaded or load is unbalanced.	Reduce weight or redistribute drawer contents.

GE Appliances Gas Range Warranty

GEAppliances.ca

All warranty service is provided by our Factory Service Centers, or an authorized Customer Care® technician. To schedule service online, visit us at www.geappliances.com/service_and_support/, or call 1.800.561.3344. Please have your serial number and your model number available when calling for service.

Servicing your appliance may require the use of the onboard data port for diagnostics. This gives a GE Appliances factory service technician the ability to quickly diagnose any issues with your appliance and helps GE Appliances improve its products by providing GE Appliances with information on your appliance. If you do not want your appliance data to be sent to GE Appliances, please advise your technician not to submit the data to GE Appliances at the time of service.

For the period of	MC Commercial will replace
One year From the date of the original purchase	Any part of the range which fails due to a defect in materials or workmanship. During this limited one-year warranty , MC Commercial will provide, free of charge , all labor and in-home service to replace the defective part.

What MC Commercial will not cover:

- Service trips to your home to teach you how to use the product.
- Improper installation, delivery, or maintenance.
- Failure of the product if it is abused, misused, modified, or used for other than the intended purpose or used commercially.
- Replacement of house fuses or resetting of circuit breakers.
- Damage to the product caused by accident, fire, floods, or acts of God.
- Damage to finish, such as surface rust, tarnish, or small blemishes not reported within 48 hours of delivery.
- Incidental or consequential damage caused by possible defects with this appliance.
- Damage caused after delivery.
- Product not accessible to provide required service.
- Service to repair or replace light bulbs, except for LED lamps.

EXCLUSION OF IMPLIED WARRANTIES

Your sole and exclusive remedy is product repair as provided in this Limited Warranty. Any implied warranties, including the implied warranties of merchantability or fitness for a particular purpose, are limited to one year or the shortest period allowed by law.

This warranty is extended to the original purchaser and any succeeding owner for products purchased for home use within Canada. If the product is located in an area where service by a MC Commercial Authorized Servicer is not available, you may be responsible for a trip charge or you may be required to bring the product to an Authorized MC Commercial Service location for service.

Some provinces do not allow the exclusion or limitation of incidental or consequential damages. This warranty gives you specific legal rights, and you may also have other rights which vary from province to province. To know what your legal rights are, consult your local or provincial consumer affairs office.

Warrantor: MC Commercial Inc., Burlington, Ontario

Extended Warranties: Purchase a GE Appliances extended warranty and learn about special discounts that are available while your warranty is still in effect. You can purchase it online anytime at

<http://www.geappliances.ca/en/support/>
<http://www.electromenagersge.ca/fr/soutien/>

or call 1.800.561.3344 during normal business hours. GE Appliances Service will still be there after your warranty expires.

Staple your receipt here. Proof of the original purchase date is needed to obtain service under the warranty.

Accessories

Looking For Something More?

GE Appliances offers a variety of accessories to improve your cooking and maintenance experiences!

Refer to the Consumer Support page for phone numbers and website information.

The following products and more are available:

Accessories

Nickel Flat Rack

Reinforced Nickel Flat Rack

Self Clean Flat Rack

Nickel Extension Rack

Self Clean Extension Rack

Broiler Pan (12 ¾" x 1 ¼" x 16 ½")
(32.4 cm x 3.2 cm x 41.9 cm)

Roasting Rack Accessory

Cooktop Center Grate

Nonstick Aluminum Griddle

Reversible Cast-Iron Griddle

Cleaning Supplies

CitruShine™ Stainless Steel Wipes

CStainless Steel Polishing Cloth

CERAMA BRYTE® Burnt-On Grease Remover

Notes

Please place in envelope and mail to:
Veuillez mettre dans une enveloppe et envoyez à :

**OWNERSHIP REGISTRATION
P.O. BOX 1780
MISSISSAUGA, ONTARIO
L4Y 4G1**

**(FOR CANADIAN CONSUMERS ONLY -
POUR RÉSIDENTS CANADIENS SEULEMENT)**



For Canadian
Customers



Pour les
consommateurs
canadiens

CUT ALONG THIS LINE AND RETURN CARD - THANKS
DÉCOUPEZ ICI ET ENVOYEZ LA FICHE - MERCI

OWNERSHIP REGISTRATION CERTIFICATE – FICHE D'INSCRIPTION DU PROPRIÉTAIRE

Please register your product to enable us to contact you in the remote event a safety notice is issued for this product and to allow for efficient communication under the terms of our warranty, should the need arise. Veuillez enregistrer votre produit afin de nous permettre de communiquer avec vous si jamais un avis de sécurité concernant ce produit était émis et de communiquer facilement avec vous en vertu de votre garantie, si le besoin s'en fait sentir.

REGISTER ON-LINE: www.geappliances.ca MAIL TO: **P.O. BOX 1780, MISSISSAUGA**
ENREGISTREMENT SUR INTERNET À : www.electromenagersge.ca POSTEZ À : **ONTARIO, L4Y 4G1**

MR. / M. MRS. / MME FIRST NAME / PRÉNOM LAST NAME / NOM
 MISS/MLE MS.

STREET NO / N° RUE STREET NAME / RUE APT.NO/APP./RR#

CITY / VILLE PROVINCE POSTAL CODE/CODE POSTAL

AREA CODE/IND. RÉG. TELEPHONE/TÉLÉPHONE E-MAIL/COURRIEL

DID YOU PURCHASE A SERVICE CONTRACT FOR THIS APPLIANCE? YES/OUI IF YES/SI OUI : EXPIRATION
AVEZ-VOUS ACHETÉ UN CONTRAT DE SERVICE POUR CET APPAREIL ? NO/NON Y/A M DU

NAME OF SELLING DEALER / NOM DU MARCHAND MODEL / MODÈLE

INSTALLATION DATE / DATE D'INSTALLATION CORRESPONDENCE ENGLISH
Y/A M DU CORRESPONDANCE FRANÇAIS SERIAL / SÉRIE

I do not wish to receive any promotional offers regarding this product.
Je ne désire pas recevoir d'offres promotionnelles concernant ce produit.

Notes

Consumer Support

GE Appliances Website

Have a question or need assistance with your appliance? Try the GE Appliances Website 24 hours a day, any day of the year! You can also shop for more great GE Appliances products and take advantage of all our on-line support services designed for your convenience. In Canada: **GEAppliances.ca**

Register Your Appliance

Register your new appliance on-line at your convenience! Timely product registration will allow for enhanced communication and prompt service under the terms of your warranty, should the need arise. You may also mail in the pre-printed registration card included in the packing material. In Canada: **GEAppliances.ca/en/support/**

Schedule Service

Expert GE Appliances repair service is only one step away from your door. Get on-line and schedule your service at your convenience any day of the year. In Canada: **GEAppliances.ca/en/support/service-request** or call 1.800.561.3344 during normal business hours.

Extended Warranties

Purchase a GE Appliances extended warranty and learn about special discounts that are available while your warranty is still in effect. You can purchase it on-line anytime. GE Appliances Services will still be there after your warranty expires. In Canada: **GEAppliances.ca/en/support/purchase-extended-warranty** or call 1.800.561.3344 during normal business hours.

Remote Connectivity

For assistance with wireless network connectivity (for models with remote enable), visit our website at **GEAppliances.com/ge/connected-appliances/** or call 1.800.220.6899 in the US.

Parts and Accessories

Individuals qualified to service their own appliances can have parts or accessories sent directly to their homes (VISA, MasterCard and Discover cards are accepted). Order on-line today 24 hours every day. In Canada: **GEAppliances.ca** or by phone at 1.800.661.1616 during normal business hours.

Instructions contained in this manual cover procedures to be performed by any user. Other servicing generally should be referred to qualified service personnel. Caution must be exercised, since improper servicing may cause unsafe operation.

Contact Us

If you are not satisfied with the service you receive from GE Appliances, contact us on our Website with all the details including your phone number, or write to:

In Canada: Director, Consumer Relations | MC Commercial Inc., 1 Factory Lane, Suite 310 | Moncton, N.B. E1C 9M3
GEAppliances.ca/en/contact-us or call 1.877.994.5366.