



Built-In Gas Wall Oven

Safety Instructions 2-5

Operating Instructions, Tips

Aluminum foil 5, 12, 20
 Baking feature 12, 13
 Broiling feature 16, 17
 Clock and timer 7
 Control features and settings 6
 Ignition 11
 Light 11
 Preheating 12
 Racks 11, 12
 Roasting feature 13
 Sabbath feature 10
 Self-cleaning instructions 18, 19
 Special features of your oven control 8, 9
 Timed baking 14
 Type of margarine 15
 Vent 11

Care and Cleaning

Burner air adjustment shutters 22
 Control panel 21
 Door removal 21
 Light replacement 20
 Orifice hood adjustment 22
 Oven bottom 20
 Oven vents 19
 Racks 20
 Self-cleaning instructions 18, 19
 Stainless Steel Surfaces 21
 Storage drawer 19

Write the model and serial numbers here:

Model # _____

Serial # _____

You can find them on a label on the front of the oven behind the door.

Before You Call For Service

Thermostat adjustment – do it yourself 15
 Troubleshooting tips 23-25

Consumer Support

Accessories 26
 Consumer Support Back Cover
 Warranty 27

Owner's Manual

JGRP20

***IMPORTANT SAFETY INFORMATION.
READ ALL INSTRUCTIONS BEFORE USING.***

 *WARNING:* If the information in this manual is not followed exactly, a fire or explosion may result, causing property damage, personal injury or death.

- Do not store or use gasoline or other flammable vapors and liquids in the vicinity of this or any other appliance.
- ***WHAT TO DO IF YOU SMELL GAS***
 - Do not try to light any appliance.
 - Do not touch any electrical switch; do not use any phone in your building.
 - Immediately call your gas supplier from a neighbor's phone. Follow the gas supplier's instructions.
 - If you cannot reach your gas supplier, call the fire department.
- Installation and service must be performed by a qualified installer, service agency or the gas supplier.

SAVE THESE INSTRUCTIONS

STATE OF CALIFORNIA PROPOSITION 65 WARNING

The California Safe Drinking Water and Toxic Enforcement Act requires the Governor of California to publish a list of substances known to the state to cause cancer, birth defects or other reproductive harm, and requires businesses to warn customers of potential exposure to such substances.

⚠ WARNING This product contains one or more chemical known to the State of California to cause cancer, birth defects or other reproductive harm.

Self-clean ovens can cause low-level exposure to some of these substances, including carbon monoxide, during the cleaning cycle. Exposure can be minimized by venting with an open window or using a ventilation fan or hood.

⚠ WARNING GENERAL SAFETY INSTRUCTIONS

⚠ WARNING NEVER use this appliance as a space heater to heat or warm the room. Doing so may result in carbon monoxide poisoning and overheating of the oven.

- Use this appliance for its intended purpose as described in this owner's manual.
- Have your range installed and properly grounded by a qualified installer in accordance with the provided installation instructions. Any adjustment and service should be performed only by a qualified gas range installers or service technicians. Do not attempt to repair or replace any part of your range unless it is specifically recommended in this manual.
- Your range is shipped from the factory set for use with natural gas. It can be converted for use with LP gas. If required, these adjustments must be made by a qualified technician in accordance with the installation instructions and local codes. The agency performing this work assumes responsibility for the conversion.
- Have the installer show you the location of the range gas shut-off valve and how to turn it off if necessary.
- Plug your range into a 120-volt grounded outlet only. Do not remove the round grounding prong from the plug. If in doubt about the grounding of the home electrical system, it is your responsibility and obligation to have an ungrounded outlet replaced with a properly grounded, three prong outlet in accordance with the National Electrical Code. Do not use on extension cord with this appliance.
- Before performing any service, unplug the range or disconnect the power supply at the household distribution panel by removing the fuse or switching off the circuit breaker.
- Be sure all packing materials are removed from the range before operating to prevent ignition of these materials.
- Avoid scratching or impacting glass doors, cooktops or control panels. Doing so may lead to glass breakage. Do not cook on a product with broken glass. Shock, fire or cuts may occur.
- Do not leave children alone—children should not be left alone or unattended in an area where an appliance is in use. They should never be allowed to climb, sit or stand on any part of the appliance.
- **⚠ CAUTION** Do not store items of interest to children in cabinets above an oven - children climbing on the oven to reach items could be seriously injured.
- Do not allow anyone to climb, stand or hang on the oven door or drawer. They could damage the range or tip it over causing severe injury or death.

SAVE THESE INSTRUCTIONS

IMPORTANT SAFETY INFORMATION. **READ ALL INSTRUCTIONS BEFORE USING.**

⚠ WARNING GENERAL SAFETY INSTRUCTIONS

- Never block the vents (air openings) of the range. They provide the air inlets and outlets that are necessary for the range to operate properly with correct combustion. Air openings are located at the top and bottom of the oven door, and at the bottom of the range under lower oven drawer or panel.
- Use only dry pot holders—moist or damp pot holders on hot surfaces may result in burns from steam. Do not let pot holders touch burner grate or oven heating element. Do not use a towel or other bulky cloth in place of pot holders.
- Do not touch the heating elements or the interior surface of the oven. These surfaces may be hot enough to burn even though they are dark in color.
- During and after use, do not touch, or let clothing or other flammable materials contact any interior area of the oven; allow sufficient time for cooling first. Other surfaces of the appliance may become hot enough to cause burns. Potentially hot surfaces include the oven vent opening, surfaces near the opening and crevices around the oven door.
- Do not heat unopened food containers. Pressure could build up and the container could burst, causing an injury.
- Cook meat and poultry thoroughly—meat to at least an internal temperature of 160°F and poultry to at least an internal temperature of 180°F. Cooking to these temperatures usually protects against foodborne illness.

⚠ WARNING KEEP FLAMMABLE MATERIALS AWAY FROM THE OVEN *Failure to do so may result in fire or personal injury.*

- Do not store or use flammable materials in an oven including paper, plastic, pot holders, linens, wall coverings, curtains, drapes and gasoline or other flammable vapors and liquids.
- Never wear loose-fitting or hanging garments while using the appliance. Avoid storing commonly used items in cabinets above the range and be careful when reaching over the range. Clothing in close proximity to burners or hot surfaces may ignite causing severe burns.
- Do not let cooking grease or other flammable materials accumulate in or near the range. Grease in the oven may ignite.
- Clean ventilating hoods frequently. Grease should not be allowed to accumulate on the hood or filter.

⚠ WARNING IN THE EVENT OF A FIRE, TAKE THE FOLLOWING STEPS TO PREVENT INJURY AND FIRE SPREADING

- If there is a fire in the oven during baking, turn the oven off and keep the door closed until the fire goes out. If necessary, use a multi-purpose dry chemical or foam type fire extinguisher. Do not use water on grease fires. Never pick up a flaming pan.
- If there is a fire in the oven during self-clean, turn the oven off and wait for the fire to go out. Do not force the door open. Introduction of fresh air at self-clean temperatures may lead to a burst of flame from the oven. Failure to follow this instruction may result in severe burns.

SAVE THESE INSTRUCTIONS

⚠ WARNING OVEN SAFETY INSTRUCTIONS

⚠ WARNING NEVER cover any slots, holes, or passages in the oven bottom or cover an entire rack with materials such as aluminum foil or oven liners. Doing so blocks air flow through the oven and may cause carbon monoxide poisoning. Never place foil or oven liners on the oven bottom. They can trap heat causing risk of smoke or fire.

- Use this appliance for its intended purpose as described in this owner's manual.
- Stand away from the range when opening the oven door. Hot air or steam which escapes can cause burns to hands, face and/or eyes.
- Keep the oven free from grease buildup. Grease in the oven may ignite.
- Place oven racks in desired location while oven is cool. If rack must be moved while oven is hot, be careful to avoid touching hot surfaces.
- Pull the oven rack to the stop-lock position when loading and unloading food from the oven. This helps prevent burns from touching hot surfaces of the door and oven walls.
- Do not leave items such as paper, cooking utensils or food in the oven when not in use. Items stored in an oven can ignite.
- Do not leave items on the cooktop near the oven vent which is in the center of the backguard. Items may overheat resulting in a risk of fire or burns.
- When using cooking or roasting bags in the oven, follow the manufacturer's directions.
- Never broil with door open. Open-door broiling is not permitted due to overheating of controls.

⚠ WARNING SELF-CLEANING OVEN SAFETY INSTRUCTIONS

The self-cleaning feature operates the oven at temperatures high enough to burn away food soils in the oven. Follow these instructions for safe operation.

- Do not touch oven surfaces during self-clean operation. Keep children away from the oven during self-cleaning. Failure to follow these instructions may cause burns.
- Before operating the self-clean cycle, remove pans, shiny metal oven racks and other utensils from the oven. Only porcelain-coated oven racks may be left in the oven. Do not use self-clean to clean other parts, such as grates.
- Before operating the self-clean cycle, wipe grease and food soils from the oven. Excessive amount of grease may ignite leading to smoke damage to your home.
- If the self-cleaning mode malfunctions, turn the oven off and disconnect the power supply. Have it serviced by a qualified technician.
- Do not use oven cleaners. No commercial oven cleaner or oven liner protective coating of any kind should be used in or around any part of the oven.

SAVE THESE INSTRUCTIONS

Using the oven controls.

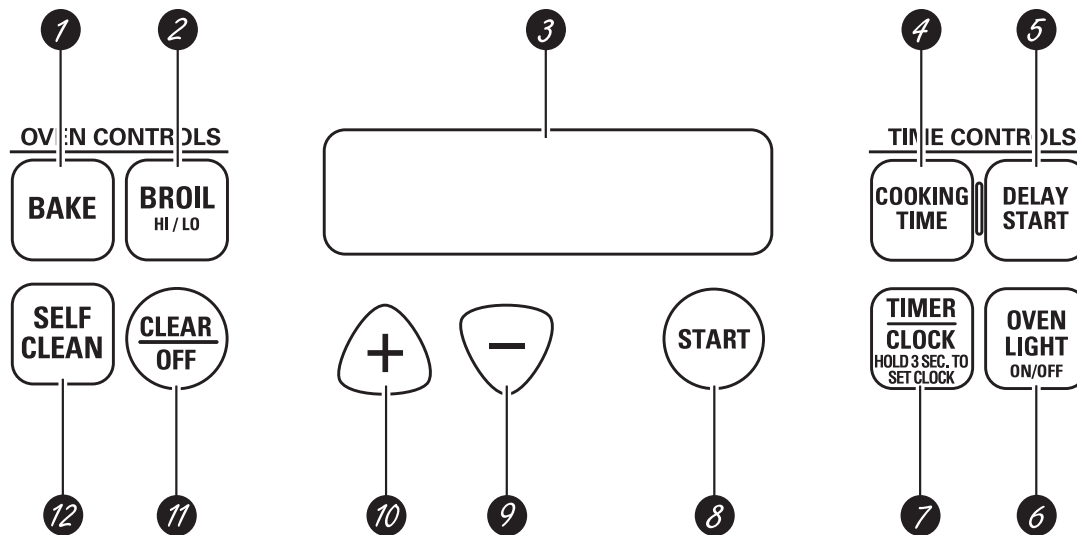

Oven Control, Clock and Timer Features and Settings

- 1** **BAKE Pad**
Touch this pad to select the bake function.
BAKE Light
Flashes while in edit mode—you can change the oven temperature at this point. Glows when the oven is in bake mode.
 - 2** **BROIL HI/LO Pad**
Touch this pad to select the broil function.
BROIL Light
Flashes while in edit mode—you can switch from **HI** to **LO BROIL** at this point. Glows when the oven is in broil mode.
 - 3** **Display**
Shows the operations you have selected, the time of day and the cooking status.
 - 4** **COOKING TIME Pad**
Touch this pad and then touch the + or - pad to set the amount of time you want your food to cook. The oven will shut off when the cooking time has run out.
 - 5** **DELAY START Pad**
Use along with the **COOKING TIME** or **SELF CLEAN** pad to set the oven to start and stop automatically at a time you set.
 - 6** **OVEN LIGHT ON/OFF Pad**
Touch this pad to turn the oven light on or off.
 - 7** **TIMER/CLOCK Pad**
Touch this pad to select the timer feature. Then touch + and - pads to adjust time.

To set the clock, touch this pad twice and hold 3 seconds and then touch the + and - pads. The time of day will flash in the display when the oven is first turned on.
 - 8** **START Pad**
Must be touched to start any cooking function.
 - 9** **- Pad**
Short taps to this pad will decrease the time or temperature by small amounts. Touch and hold the pad to decrease the time or temperature by larger amounts.
 - 10** **+ Pad**
Short taps to this pad will increase the time or temperature by small amounts. Touch and hold the pad to increase the time or temperature by larger amounts.
 - 11** **CLEAR/OFF Pad**
Touch this pad to cancel **ALL** oven operations except the clock and timer.
 - 12** **SELF CLEAN Pad**
Touch this pad to select the self-cleaning function. See the *Using the self-cleaning oven* section.
CLEAN Light
Flashes while in edit mode—you can change the length of time for the self-clean cycle at this point. Glows when the oven is in the self-clean cycle. After the self-clean cycle, the light will turn off. Unlatch the door.
- If "F-" and a number or letter flash in the display and the oven control signals, this indicates a function error code.*
- Touch the CLEAR/OFF pad. Allow the oven to cool for one hour. Put the oven back into operation.*
- If function error code repeats, disconnect power to the oven and call for service.*

Not all features are on all models.

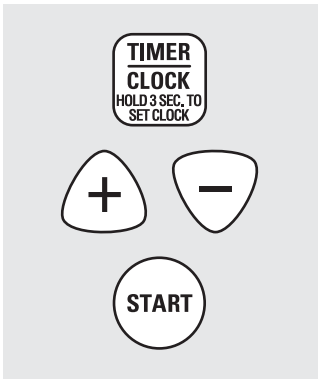

Make sure the clock is set to the correct time of day.

To Set the Clock

The clock must be set to the correct time of day for the automatic oven timing functions to work properly. The time of day cannot be changed during a delayed cooking or a delayed self-cleaning cycle.

- 1 Touch the **TIMER/CLOCK** pad twice.
- 2 Touch the **+** or **-** pad.

If the **+** or **-** pad is not touched within one minute after you touch the **TIMER/CLOCK** pad,

the display reverts to the original setting. If this happens, touch the **TIMER/CLOCK** pad twice and reenter the time of day.

- 3 Touch the **START** pad until the time of day shows in the display. This enters the time and starts the clock.

To check the time of day when the display is showing other information, simply touch the **CLOCK** pad. The time of day shows until another pad is touched.

To Turn Off the Clock Display

If you have several clocks in your kitchen, you may wish to turn off the time of day clock display on your oven.

- 1 Touch the **TIMER/CLOCK** pad once to turn off the time of day display. Although

you will not be able to see it, the clock maintains the correct time of day.

- 2 Touch the **TIMER/CLOCK** pad twice to recall the clock display.

To Set the Timer

The timer does not control oven operations. The maximum setting on the timer is 9 hours and 59 minutes.

- 1 Touch the **TIMER/CLOCK** pad.
- 2 Touch the **+** or **-** pad until the amount of time you want shows in the display. The maximum time that can be entered in minutes is 59. Times more than 59 minutes should be changed to hours and minutes.

If you make a mistake, touch the **TIMER/CLOCK** pad and begin again.

- 3 Touch the **START** pad. The time will start counting down, although the display does not change until one minute has passed.
- 4 When the timer reaches :00, the control will beep 3 times followed by one beep every 6 seconds until the **TIMER/CLOCK** pad is touched.

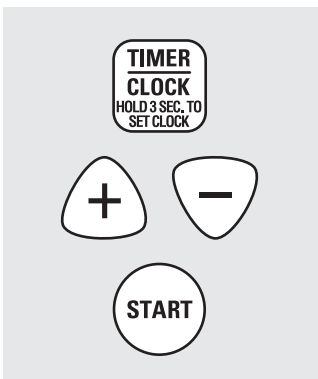

The timer is a minute timer only.
The **CLEAR/OFF** pad does not affect the timer.

To Reset the Timer

If the display is still showing the time remaining, you may change it by touching the **TIMER/CLOCK** pad, then touching the **+** or **-** pad until the time you want appears in the display.

If the remaining time is not in the display (clock, start time or cooking time are in the display), recall the remaining time by touching the **TIMER/CLOCK** pad and then touching the **+** or **-** pad to enter the new time you want.

To Cancel the Timer

Touch the **TIMER/CLOCK** pad twice.

Special features of your oven control.

Your new touch pad control has additional features that you may choose to use. The following are the features and how you may activate them.

The special feature modes can only be activated while the display is showing the time of day clock. They remain in the control's memory until the steps are repeated.

When the display shows your choice, touch the **START** pad. The special features will remain in memory after a power failure, except for the Sabbath feature, which will have to be reset.

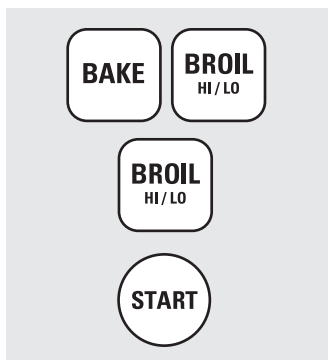

Tones at the End of a Timed Cycle

At the end of a timed cycle, 3 short beeps will sound followed by one beep every 6 seconds, until the **CLEAR/OFF** pad is touched. This continuous 6-second beep may be canceled.

To cancel the 6-second beep:

- 1 Touch the **BAKE** and **BROIL HI/LO** pads at the same time for 2 seconds until the display shows **SF**.

- 2 Touch the **BROIL HI/LO** pad. The display shows **CON BEEP** (continuous beep). Touch the **BROIL HI/LO** pad again. The display shows **BEEP**. (This cancels the one beep every 6 seconds.)

- 3 Touch the **START** pad.

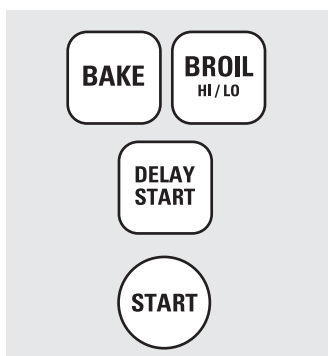

12-Hour Shut-Off

With this feature, should you forget and leave the oven on, the control will automatically turn off the oven after 12 hours during baking functions or after 3 hours during a broil function.

If you wish to turn **OFF** this feature, follow the steps below:

- 1 Touch the **BAKE** and **BROIL HI/LO** pads at the same time for 2 seconds until the display shows **SF**.

- 2 Touch the **DELAY START** pad. The display will show **12 shdn** (12 hour shut-off). Touch the **DELAY START** pad again and the display will show **no shdn** (no shut-off).

- 3 Touch the **START** pad to activate the no shut-off and leave the control set in this special features mode.

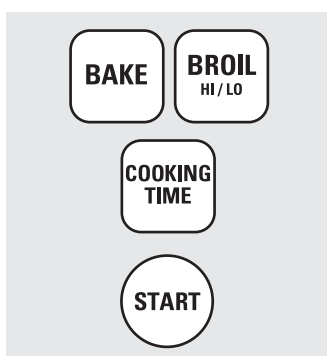

Cook and Hold

Your new control has a cook and hold feature that keeps cooked foods warm for up to 3 hours after the cooking function is finished.

To activate this feature, follow the steps below:

- 1 Touch the **BAKE** and **BROIL HI/LO** pads at the same time for 2 seconds until the display shows **SF**.

- 2 Touch the **COOKING TIME** pad. The display will show **Hld OFF**.

Touch the **COOKING TIME** pad again to activate the feature. The display will show **Hld ON**.

- 3 Touch the **START** pad to activate the cook and hold feature and leave the control set in this special features mode.

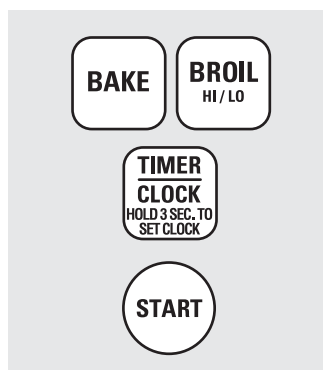

12-Hour, 24-Hour or Clock Black-Out

Your control is set to use a 12-hour clock.

If you would prefer to have a 24-hour military time clock or black-out the clock display, follow the steps below:

- 1 Touch the **BAKE** and **BROIL HI/LO** pads at the same time for 2 seconds until the display shows **SF**.
- 2 Touch the **TIMER/CLOCK** pad once. The display will show **12 hr**.

Touch the **TIMER/CLOCK** pad again to change to the 24-hour military time clock. The display will show **24 hr**.

Touch the **TIMER/CLOCK** pad again to black-out the clock display. The display will show **OFF**.

- 3 Touch the **START** pad to activate your choice and leave the control set in this special features mode.

NOTE: If the clock is in the black-out mode you will not be able to use the Delay Start function.

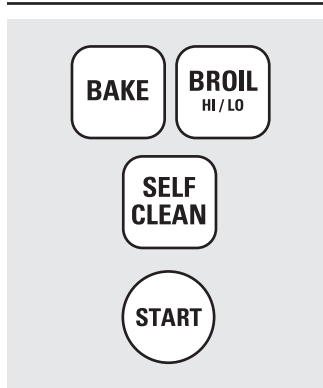

Control Lockout

Your control will allow you to lock out the touch pads so they cannot be activated when touched.

To lock the controls:

- 1 Touch the **BAKE** and **BROIL HI/LO** pads at the same time for 2 seconds until the display shows **SF**.
- 2 Touch the **SELF CLEAN** pad. The display will show **LOC OFF**.

Touch the **SELF CLEAN** pad again. The display will show **LOC**.

- 3 Touch the **START** pad to activate the control lockout feature and leave the control set in this special features mode.

When this feature is on and the touch pads are touched the control will beep and the display will show **LOC**.

NOTE: The control lockout mode will not affect the clock, timer and oven light touch pads.

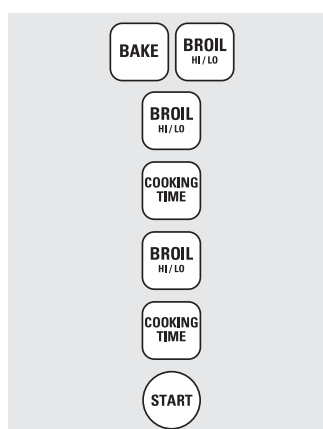

Fahrenheit or Centigrade Temperature Selection

Your oven control is set to use the Fahrenheit temperature selections but you may change this to use the Centigrade selections.

- 1 Touch the **BAKE** and **BROIL HI/LO** pads at the same time for 2 seconds until the display shows **SF**.
- 2 Touch the **BROIL HI/LO** and **COOKING TIME** pads at the same time for 2 seconds. The display will show **F** (Fahrenheit).

- 3 Touch the **BROIL HI/LO** and **COOKING TIME** pads again at the same time for 2 seconds. The display will show **C** (Centigrade).

- 4 Touch the **START** pad.

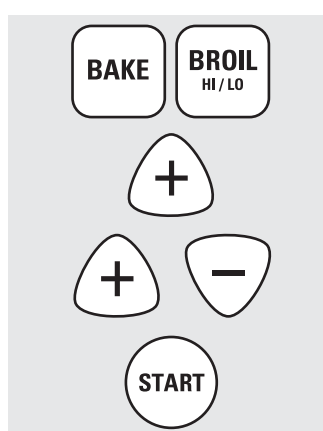

Changing the Speed of the +/- Pads

As you use the +/- pads when setting a time or temperature, you may notice the display changes slowly. This special feature allows you to change the speed.

To set the speed you prefer, follow the steps below:

- 1 Touch the **BAKE** and **BROIL HI/LO** pads at the same time for 2 seconds until the display shows **SF**.
- 2 Touch the **+** pad. The display will show you a set speed between 1 and 5.

- 3 Touch the **+** pad to increase the speed up to the number 5.

Touch the **-** pad to decrease the speed down to the number 1.

- 4 Touch the **START** pad to activate the setting and leave the control set in this special features mode.

Using the Sabbath Feature.

(Designed for use on the Jewish Sabbath and Holidays.) (on some models)

The Sabbath feature can be used for baking/roasting only. It cannot be used for broiling, self-cleaning, or Delay Start cooking.

NOTE: The oven light comes on automatically (on some models) when the door is opened and goes off when the door is closed. The bulb may be removed. See the Oven Light Bulb section. On models with a light switch on the control panel, the oven light may be turned on and left on.

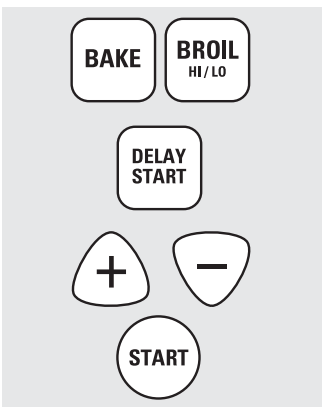

When the display shows \supset the oven is set in Sabbath. When the display shows $\supset \subset$ the oven is baking/roasting.

How to Set Sabbath Feature for Regular Baking/Roasting

NOTE: To understand how the oven control works, practice using regular baking (non-Sabbath) before entering Sabbath mode.

Make sure the clock shows the correct time of day.

- 1 Touch and hold **both** the **BAKE** and **BROIL HI/LO** pads, **at the same time**, until the display shows **SF**.

NOTE: If bake or broil appears in the display, the **BAKE** and **BROIL HI/LO** pads were not touched at the same time. Touch the **CLEAR/OFF** pad and begin again.

- 2 Tap the **DELAY START** pad until **Sab bath** appears in the display.
- 3 Touch the **START** pad and \supset will appear in the display.
- 4 Touch the **BAKE** pad. No signal will be given.

- 5 The preset starting temperature will automatically be set to 350°. Tap the **+** or **-** pad to increase or decrease the temperature in 5° increments. The temperature can be set between 170° and 550°. No signal or temperature will be given.

- 6 Touch the **START** pad.

- 7 After a random delay period of approximately 30 seconds to 1 minute, $\supset \subset$ will appear in the display indicating that the oven is baking/roasting. If $\supset \subset$ does not appear in the display, start again at step 4.

To adjust the oven temperature, touch the **BAKE** pad and tap the **+** or **-** pad to increase or decrease the temperature in 5° increments. Touch the **START** pad.

NOTE: The **CLEAR/OFF** and **COOKING TIME** pads are active during the Sabbath feature.

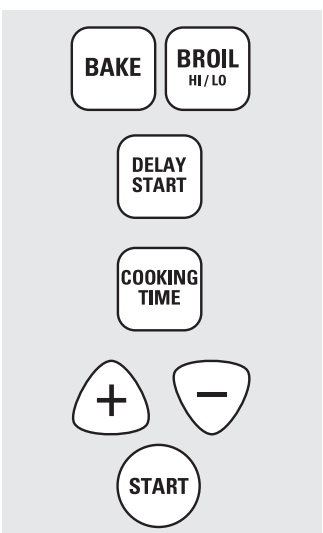

When the display shows \supset the oven is set in Sabbath. When the display shows $\supset \subset$ the oven is baking/roasting.

How to Set Sabbath Feature for Timed Baking/Roasting— Immediate Start and Automatic Stop

NOTE: To understand how the oven control works, practice using regular (non-Sabbath) Immediate Start and Automatic Stop before entering the Sabbath mode.

Make sure the clock shows the correct time of day.

- 1 Touch and hold **both** the **BAKE** and **BROIL HI/LO** pads, **at the same time**, until the display shows **SF**.

NOTE: If bake or broil appears in the display, the **BAKE** and **BROIL HI/LO** pads were not touched at the same time. Touch the **CLEAR/OFF** pad and begin again.

- 2 Tap the **DELAY START** pad until **Sab bath** appears in the display.
- 3 Touch the **START** pad and \supset will appear in the display.
- 4 Touch the **COOKING TIME** pad.

- 5 Touch the **+** or **-** pad to set the desired length of cooking time between 1 minute and 9 hours and 59 minutes. The cooking time that you entered will be displayed.

- 6 Touch the **START** pad.

- 7 Touch the **BAKE** pad. No signal will be given.

- 8 The preset starting temperature will automatically be set to 350°. Tap the **+** or **-** pad to increase or decrease the temperature in 5° increments. The temperature can be set between 170° and 550°. No signal or temperature will be given.

- 9 Touch the **START** pad.

- 10 After a random delay period of approximately 30 seconds to 1 minute, $\supset \subset$ will appear in the display indicating that the oven is baking/roasting. If $\supset \subset$ does not appear in the display, start again at step 7.

To adjust the oven temperature, touch the **BAKE** pad and tap the **+** or **-** pad to increase or decrease the temperature in 5° increments. Touch the **START** pad.

When cooking is finished, the display will change from $\supset \subset$ to \supset and **0:00** will appear, indicating that the oven has turned **OFF** but is still set in Sabbath. Remove the cooked food.

How to Exit the Sabbath Feature

- 1 Touch the **CLEAR/OFF** pad.
- 2 If the oven is cooking, wait for a random delay period of approximately 30 seconds to 1 minute, until only \supset is in the display.
- 3 Touch and hold **both** the **BAKE** and **BROIL HI/LO** pads, **at the same time**, until the display shows **SF**.
- 4 Tap the **DELAY START** pad until **12 shdn** or **no shdn** appears in the display. **12 shdn** indicates that the oven will automatically turn off after 12 hours. **no shdn** indicates that the oven will not automatically turn off.

- 5 Touch the **START** pad.

NOTE: If a power outage occurred while the oven was in Sabbath mode, the oven will automatically turn off and the oven control must be reset.

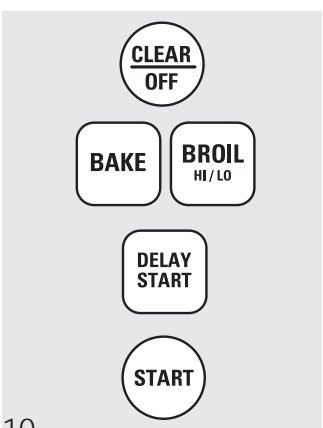

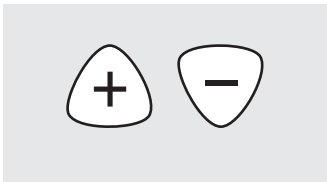

Automatic Ignition

The oven burner is lit by electric ignition.

To light the burner, do the following:

- 1 Touch the pad for the desired function. Then touch the + or - pad until the desired temperature is displayed. The burner should ignite within 60 seconds.

After the oven reaches the selected temperature, the oven burner cycles off completely, then on with a full flame to keep the oven temperature controlled.

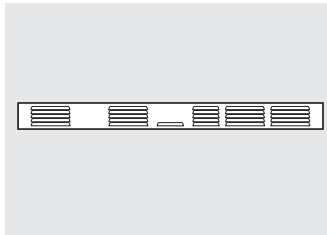

Oven Vent

When the oven is on, heated air moves through a vent behind the grille.

The vent area could get hot during oven use.

The vent is needed for proper air flow in the oven and good baking results. Do not block this vent. Doing so may cause oven failure or fire.

Power Outage

The oven burner will not light in the event of an electrical power outage.

CAUTION: Do not attempt to light it manually with a match.



Oven Light

Touch the **OVEN LIGHT** pad to turn the light on or off.

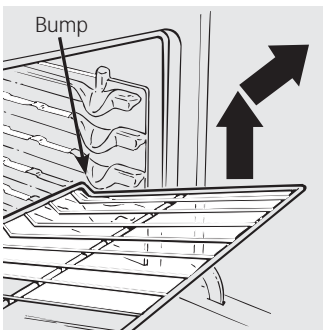

Oven Racks

The racks are designed with stop-locks so that, when placed correctly on the rack supports, they will stop before coming completely out of the oven and will not tilt when you are removing food from them or placing food on them.

When placing cookware on a rack, pull the rack out to the bump on the rack support. Place the cookware on the rack; then slide the rack back into the oven. This will eliminate reaching into the hot oven.

To remove a rack from the oven, pull the rack toward you, tilt the front end upward and pull the rack out.

To replace, place the rack on the rack support with the stop-locks (curved extension of the rack) facing up and toward the rear of the oven. Tilt up the front and push the rack toward the back of the oven until it goes past the bump on the rack support. Then lower the front of the rack and push it all the way back.

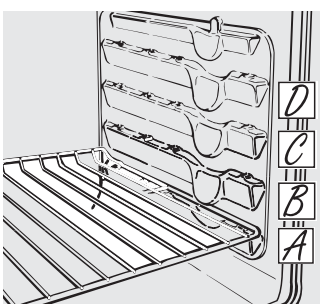

Rack Positions

The oven has 4 rack supports, identified in this illustration as A (bottom), B, C and D (top).

Rack positions for cooking are suggested in the *Baking, Roasting and Broiling* sections.

Using the baking feature.

Your oven temperature is controlled very accurately using an oven control system. It is recommended that you operate the oven for a number of weeks using the time given on recipes as a guide to become familiar with your new oven's performance. If you think an adjustment is necessary, see the *Adjust the Oven Thermostat* section. It lists easy Do It Yourself instructions on how to adjust the thermostat.

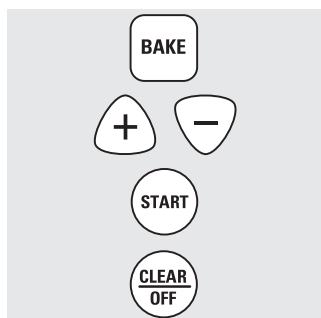

How to Set Your Oven for Baking/Roasting

To avoid possible burns, place the racks in the correct position before you turn the oven on.

- 1 Touch the **BAKE** pad.
- 2 Touch the **+** or **-** pad to set the oven temperature.
- 3 Touch the **START** pad.
When the oven starts to heat, the changing temperature will be in the display. (The display starts changing once the temperature reaches 100°F.)

To change the oven temperature during the Bake cycle, touch the **BAKE** pad and set the new temperature.

- 4 Touch the **CLEAR/OFF** pad when the baking is finished.

NOTE: A cooling fan may automatically turn on and off to cool internal parts. This is normal, and the fan may continue to run even after the oven is turned off.

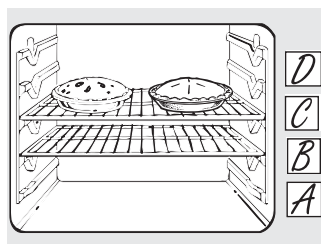

Oven Racks

Arrange the oven rack or racks in the desired locations while the oven is cool. The correct rack position depends on the kind of food and the browning desired.

As a general rule, place most foods in the middle of the oven, on either rack position **B** or **C**. See the chart for suggested rack positions.

Type of Food	Rack Position
Angel food cake	A
Frozen pies (on cookie sheet)	A
Bundt or pound cakes	A or B
Roasting	A or B
Biscuits, muffins, brownies, cookies, cupcakes, layer cakes, pies, pie shells	B or C
Casseroles	B or C

Preheating

Preheat the oven if the recipe calls for it. Preheat means bringing the oven up to the specified temperature before putting the food in the oven. To preheat, set the oven at the correct temperature—selecting a higher temperature does not shorten preheat time.

Preheating is necessary for good results when baking cakes, cookies, pastry and breads. For most casseroles and roasts, preheating is not necessary. For ovens without a preheat indicator light or tone, preheat 10 minutes. After the oven is preheated, place the food in the oven as quickly as possible to prevent heat from escaping.

Aluminum Foil and Oven Liners

⚠ CAUTION: Do not use any type of foil or oven liner to cover the oven bottom. These items can block airflow or melt, resulting in damage to the product and risk of carbon monoxide poisoning, smoke or fire. Damage from improper use of these items is not covered by the product warranty.

Foil may be used to catch spills by placing a sheet on a lower rack, several inches below the food. Do not use more foil than necessary and never entirely cover an oven rack with aluminum foil. Keep foil at least 1-1/2" from oven walls to allow air flow through the oven.

Baking Pans

Use the proper baking pan. The type of finish on the pan determines the amount of browning that will occur.

- Dark, rough or dull pans absorb heat resulting in a browner, crisper crust. Use this type for pies.
- Shiny, bright and smooth pans reflect heat, resulting in a lighter, more delicate browning. Cakes and cookies require this type of pan.
- Glass baking dishes also absorb heat. When baking in glass baking dishes, the temperature may need to be reduced by 25°F.
- If you are using dark nonstick pans, you may find that you need to reduce the oven temperature 25°F to prevent overbrowning.

Pan Placement

For even cooking and proper browning, there must be enough room for air circulation in the oven. Baking results will be better if baking pans are centered as much as possible rather than being placed to the front or to the back of the oven.

Pans should not touch each other or the walls of the oven. Allow 1- to 1½-inch space between pans as well as from the back of the oven, the door and the sides. If you need to use two racks, stagger the pans so one is not directly above the other.

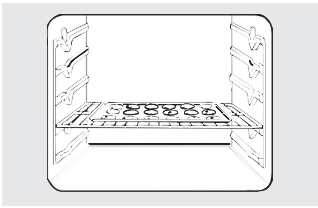

Cookies

When baking cookies, flat cookie sheets (without sides) produce better-looking cookies. Cookies baked in a jelly roll pan (short sides all around) may have darker edges and pale or light browning may occur. Do not use a cookie sheet so large that it touches

the walls or the door of the oven. Never entirely cover a rack with a large cookie sheet.

For best results during baking, use only one cookie sheet in the oven at a time.

Pies

For best results, bake pies in dark, rough or dull pans to produce a browner, crisper crust. Frozen pies in foil pans should be placed on an aluminum cookie sheet for baking since the shiny foil pan reflects heat away from the pie crust; the cookie sheet helps retain it.

Cakes

When baking cakes, warped or bent pans will cause uneven baking results and poorly shaped products. A cake baked in a pan larger than the recipe recommends will usually be crisper, thinner and drier than it should be. If baked in a pan smaller than recommended, it may be undercooked and batter may overflow. Check the recipe to make sure the pan size used is the one recommended.

Peeking

Set the timer for the estimated cooking time and do not open the door to look at your food. Most recipes provide minimum and maximum baking times such as "bake 30-40 minutes."

DO NOT open the door to check until the minimum time. Opening the oven door frequently during cooking allows heat to escape and makes baking times longer. Your baking results may also be affected.

Using the roasting feature.

Roasting is cooking by dry heat. Tender meat or poultry can be roasted uncovered in your oven. Roasting temperatures, which should be low and steady, keep spattering to a minimum.

Before You Begin Roasting...

Roasting is really a baking procedure used for meats. Therefore, the oven controls are set for Baking or Timed Baking. (You may hear a slight clicking sound, indicating the oven is working properly.) Timed Baking will turn the oven on and off automatically.

Most meats continue to cook slightly after being removed from the oven. The internal temperature will rise about 5° to 10°F during the recommended

standing time of 10 to 20 minutes. This allows roasts to firm up and makes them easier to carve.

To compensate for this rise in temperature, you may want to remove the roast sooner (at 5° to 10°F less than the temperature in the Roasting Guide).

REMEMBER: Food will continue to cook in the hot oven and therefore should be removed when the desired internal temperature has been reached.

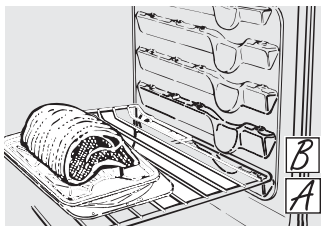

How to Set Your Oven for Roasting

- 1 Place the rack in **A** or **B** position. No preheating is necessary.
- 2 Check the weight of the meat. Place the meat fat side up, or poultry breast side up, on roasting grid in a shallow pan. The melting fat will baste the meat. Select a pan as close to the size of the meat as possible. (A broiler pan with grid is a good pan for this.)
- 3 Touch the **BAKE** pad.

To change the oven temperature during the roasting cycle, touch the **BAKE** pad and set the new temperature.

- 4 Touch the **+** or **-** pad to set the oven temperature.

- 5 Touch the **START** pad.

- 6 Touch the **CLEAR/OFF** pad when roasting is finished.

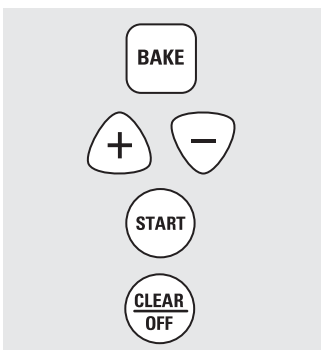

Using the timed baking feature.

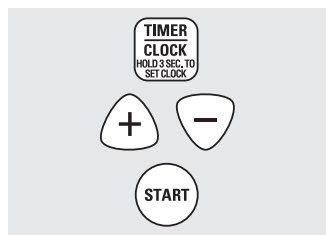

How to Set Your Oven for Time Bake

The oven control allows you to turn the oven on or off automatically at specific times that you set. Examples of Immediate Start (oven turns on now and you set it to turn off automatically at the end of cooking time) and Delay Start and Stop (setting the oven to turn on

automatically at a later time and turn off after a preset cooking time) will be described.

NOTE: An attention tone will sound if you are using Timed Baking and do not touch the **START** pad after entering the baking temperature.

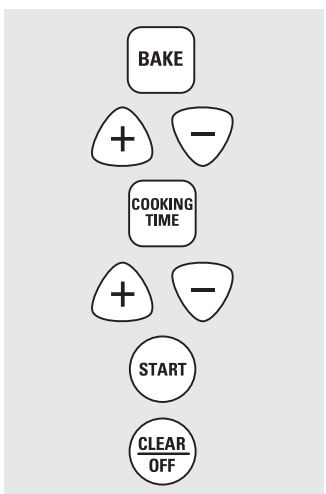

How to Set Immediate Start and Automatic Stop

! CAUTION: To avoid possible burns, place the racks in the correct position before you turn the oven on.

The oven will turn on immediately and cook for a selected length of time. At the end of cooking time, the oven will turn off automatically.

- 1 Touch the **BAKE** pad.
- 2 Touch the + or - pad to set the oven temperature.
- 3 Touch the **COOKING TIME** pad.

NOTE: If your recipe requires preheating, you may need to add additional time to the length of the cooking time.

- 4 Touch the + or - pad to set the baking time. The oven temperature and the cooking time that you entered will be displayed.

- 5 Touch the **START** pad. The display shows the oven temperature that you set and the cooking time countdown. (The display starts changing once the the temperature reaches 100°F.)

The oven will continue to cook for the programmed amount of time, then shut off automatically.

- 6 Touch the **CLEAR/OFF** pad to clear the end of cycle tone if necessary.

NOTES:

- The low temperature zone of this oven (between 170°F and 200°F) is available to keep hot cooked foods warm. Food kept in the oven longer than two hours at these low temperatures may spoil.
- Foods that spoil easily, such as milk, eggs, fish, stuffings, poultry and pork, should not be allowed to sit for more than one hour before or after cooking. Room temperature promotes the growth of harmful bacteria. Be sure the oven light is off because heat from the bulb will speed harmful bacteria growth.

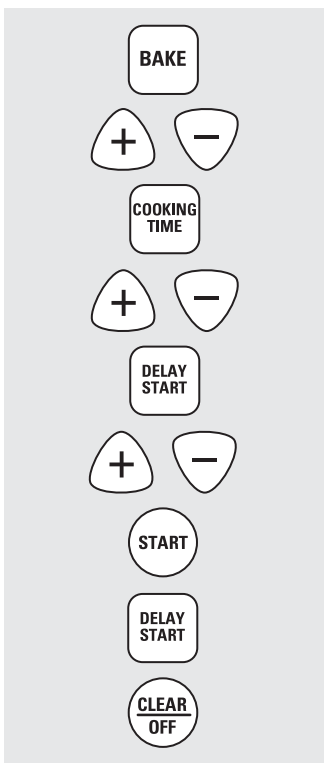

How to Set Delay Start and Automatic Stop

! CAUTION: To avoid possible burns, place the racks in the correct position before you turn the oven on.

You can set the control to delay the start of cooking, cook for a specific length of time and then turn off automatically.

- 1 Touch the **BAKE** pad.
- 2 Touch the + or - pad to set the oven temperature.
- 3 Touch the **COOKING TIME** pad.

NOTE: If your recipe requires preheating, you may need to add additional time to the length of the cooking time.

- 4 Touch the + or - pad to set the baking time.
- 5 Touch the **DELAY START** pad.
- 6 Touch the + or - pad to set the time of day you want the oven to turn on and start cooking.

- 7 Touch the **START** pad.

If you would like to check the times you have set, touch the **DELAY START** pad to check the start time you have set or touch the **COOKING TIME** pad to check the length of cooking time you have set.

When the oven turns on at the time of day you have set, the display will show the changing temperature (starting at 100°F) and the cooking time countdown.

At the end of cooking time the oven will turn off and the end of cycle tone will sound.

- 8 Touch the **CLEAR/OFF** pad to clear the end of cycle tone if necessary.

NOTES:

- The low temperature zone of this oven (between 170°F and 200°F) is available to keep hot cooked foods warm. Food kept in the oven longer than two hours at these low temperatures may spoil.
- Foods that spoil easily, such as milk, eggs, fish, stuffings, poultry and pork, should not be allowed to sit for more than one hour before or after cooking. Room temperature promotes the growth of harmful bacteria. Be sure the oven light is off because heat from the bulb will speed harmful bacteria growth.

Adjust the oven thermostat—Do it yourself!

GEAppliances.com

You may find that your new oven cooks differently than the one it replaced. Use your new oven for a few weeks to become more familiar with it. If you still think your new oven is too hot or too cold, you can adjust the thermostat yourself.

Do not use thermometers, such as those found in grocery stores, to check the temperature setting of your oven. These thermometers may vary 20–40 degrees.

NOTE: This adjustment will not affect the broiling or self-cleaning temperatures. The adjustment will be retained in memory after a power failure.

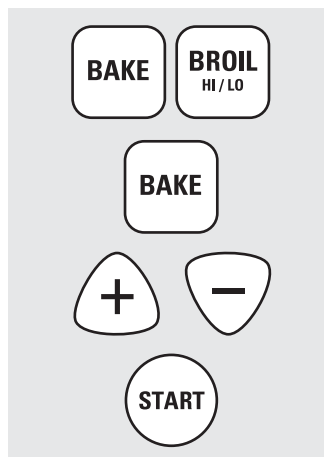

To Adjust the Thermostat

- 1 Touch the **BAKE** and **BROIL HI/LO** pads at the same time for 2 seconds until the display shows **SF**.
- 2 Touch the **BAKE** pad. A two-digit number shows in the display.
- 3 The oven temperature can be adjusted up as much as 35°F or down as much as 35°F. Touch the **+** pad to increase the temperature in 1-degree increments. Touch the **-** pad to decrease the temperature in 1-degree increments.
- 4 When you have made the adjustment, touch the **START** pad to go back to the time of day display. Use your oven as you would normally.

The type of margarine will affect baking performance!

Most recipes for baking have been developed using high-fat products such as butter or margarine (80% fat). If you decrease the fat, the recipe may not give the same results as with a higher fat product.

Recipe failure can result if cakes, pies, pastries, cookies or candies are made with low-fat spreads. The lower the fat content of a spread product, the more noticeable these differences become.

Federal standards require products labeled "margarine" to contain at least 80% fat by weight. Low-fat spreads, on the other hand, contain less fat and more water. The high moisture content of these spreads affects the texture and flavor of baked goods. For best results with your old favorite recipes, use margarine, butter or stick spreads containing at least 70% vegetable oil.

Using the broiling feature.

GEAppliances.com

Broiling is cooking food by direct heat from above the food. Most fish and tender cuts of meat can be broiled. Follow these directions to keep spattering and smoking to a minimum.

Before You Begin Broiling...

If the meat has fat or gristle around the edge, cut vertical slashes through it about 2" apart. If desired, the fat may be trimmed, leaving a layer about 1/8" thick.

Place the meat on any broiler grid in a broiler pan. Always use the grid so the fat drips into a broiler pan; otherwise the juices may become hot enough to catch on fire.

Position any broiler pan on a rack on the recommended rack position as suggested in the Broiling Guide. **Place the sump area of a broiler pan to the front of the door.**

NOTE: Always broil with the oven door closed.

Turn the food using tongs only once during

broiling. Time the foods for the first side according to the Broiling Guide.

Turn the food, then use the times given for the second side as a guide to the preferred doneness.

To test if your broiler is working properly:

Cover an entire broiler pan grid with bread. Place any broiler pan on the third rack from the bottom. Broil until the bread is golden brown. If you have browning on both sides of the pan, your broiler is working properly. If toast browns only on one side of the pan, call for service.

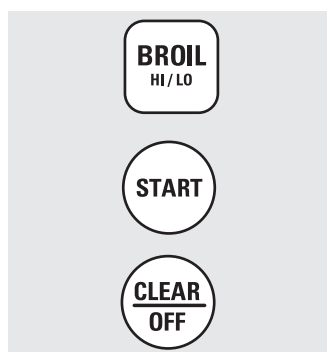

How to Set Your Oven for Broiling

- 1 Touch the **BROIL HI/LO** pad.
- 2 Touch the **BROIL HI/LO** pad again (alternates between **LO Broil** and **HI Broil**).
- 3 Touch the **START** pad.
- 4 Touch the **CLEAR/OFF** pad when broiling is finished.

Questions and Answers

Q. Are there blue flames on both sides of the broil burner?

- A. Yes, but the bright orange glow of the burner igniter may make the flame difficult to see. If you cannot see the flame on both sides and feel your broil burner is not functioning properly, try the "toast test."

Q. When broiling, is it necessary to always use a grid in the pan?

- A. Yes. Using the grid suspends the meat over the pan. As the meat cooks, the juices fall into the pan, thus keeping meat drier. Juices are protected by the grid and stay cooler, thus preventing excessive spatter and smoking.

Q. Should I salt the meat before broiling?

- A. No. Salt draws out the juices and allows them to evaporate. Always salt after cooking. Piercing the meat with a fork allows juices to escape. Turn the meat with tongs instead of a fork.

- For best results, use a pan designed for broiling. It is designed to minimize smoking and spattering by trapping the juices in the shielded lower part of the pan.
 - When arranging the food on the pan, do not let fatty edges hang over the sides because the dripping fat will soil the oven bottom.
 - The broiler does not need to be preheated. However, for very thin foods, or to increase browning, preheat if desired.
 - Use **LO Broil** to cook foods such as poultry or thick pork chops evenly without over-browning them.
 - Frozen steaks can be broiled by positioning the rack at next lowest rack position and increasing cooking time given in this guide 1½ times per side.
- NOTE:** Always broil with the oven door closed.
- For steaks and chops, slash fat evenly around the outside edges of the meat. To slash, cut crosswise through the outer fat surface just to the edge of the meat. Use tongs to turn the meat over to prevent piercing the meat and losing juices.
 - If desired, marinate meats or chicken before broiling. Or brush with barbecue sauce last 5 to 10 minutes only.

Broiling Guide

The size, weight, thickness, starting temperature, and your preference of doneness will affect broiling times. This guide is based on meats at refrigerator temperature.

†The U.S. Department of Agriculture says "Rare beef is popular, but you should know that cooking it to only 140°F means some food poisoning organisms may survive." (Source: Safe Food Book, Your Kitchen Guide, USDA Rev. June 1985.)

Food	Quantity and/or Thickness	Rack Position	First Side Time (min.)	Second Side Time (min.)	Comments
Ground Beef Well Done	1 lb. (4 patties) 1/2 to 3/4" thick	C	11-12	8-9	Space evenly. Up to 8 patties take about the same time.
Beef Steaks Rare† Medium Well Done	1" thick (1 to 1½ lbs.)	B B B	8 12-13 13	5 5-6 8-9	Steaks less than 1" thick cook through before browning. Pan frying is recommended. Slash fat.
Rare† Medium Well Done	1½" thick (2 to 2½ lbs.)	B B B	10 15 25	6-7 9-12 16-18	
Chicken Breasts	Boneless Bone-In	A A	18-20 28-30	12-15 10-13	Reduce times about 5 to 10 minutes per side for cut-up chicken. Brush each side with melted butter. Broil with skin-side-down first.
Lobster Tails	2-4 (6 to 8 oz. each)	A or B	13-16	Do not turn over.	Cut through back of shell, spread open. Brush with melted butter before broiling and after half of broiling time.
Fish Fillets Salmon Fillets	1/4 to 1/2" thick (1 lb.) 1" thick	B B	7-8 18-20	5 Skin side down Do Not Turn	Handle and turn very carefully. Brush with lemon butter before and during cooking, if desired. Preheat broiler to increase browning.
Pork Chops Well Done	2 (1/2" thick) 2 (1" thick) about 1 lb.	B B	10-12 12-13	4-5 6-8	Slash fat.
Lamb Chops Medium Well Done Medium Well Done	2 (1" thick) about 10-12 oz. 2 (1½" thick) about 1 lb.	B B B B	8 10 10 17	4-7 10 4-6 12-14	Slash fat.

Using the self-cleaning oven.

The oven door must be closed and all controls set correctly for the cycle to work properly.

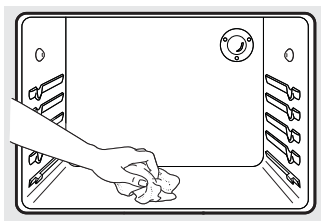

Wipe up heavy soil on the oven bottom.

Before a Clean Cycle

For the first self-clean cycle, we recommend venting your kitchen with an open window or using a ventilation fan or hood.

Remove racks, any broiler pan, broiler grid, all cookware and any aluminum foil from the oven.

The shiny, silver-colored oven racks (on some models) can be self-cleaned, but they will darken, lose their luster and become hard to slide.

Soil on the front frame of the oven and outside the gasket on the door will need to be cleaned by hand. Clean these areas with hot water, soap-filled scrubbing pads or cleansers such as Soft Scrub®. Rinse well with clean water and dry.

Do not clean the gasket. The fiberglass material of the oven door gasket cannot withstand abrasion. It is essential for the gasket to remain intact. If you notice it becoming worn or frayed, replace it.

Wipe up any heavy spillovers on the oven bottom.

Make sure the oven light bulb cover is in place and the oven light is off.

IMPORTANT: The health of some birds is extremely sensitive to the fumes given off during the self-cleaning cycle of any oven. Move birds to another well-ventilated room.

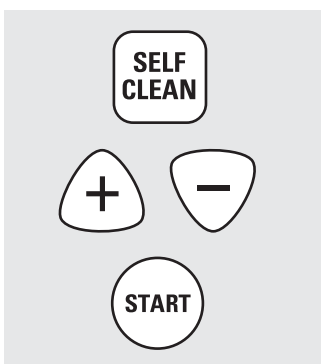

How to Set the Oven for Cleaning

- 1 Touch the **SELF CLEAN** pad.
- 2 Touch the + or - pad to enter the desired clean time, if a time other than 4 hours is needed.

Clean cycle time is normally 4 hours. You can change the clean time to any time between 3 hours and 5 hours, depending on how dirty your oven is.

- 3 Touch the **START** pad.

The door locks automatically. The display will show the clean time remaining. It will not be possible to open the oven door until the temperature drops below the lock temperature and the **LOCKED DOOR** light goes off.

When the **LOCKED DOOR** light is off, open the door.

The oven shuts off automatically when the clean cycle is complete.

NOTES:

- The words **LOCK DOOR** will flash and the oven control will signal if you set the clean cycle and forget to close the oven door.
- To stop a clean cycle, touch the **CLEAR/OFF** pad. When the **LOCKED DOOR** light goes off indicating the oven has cooled below the locking temperature, open the door.

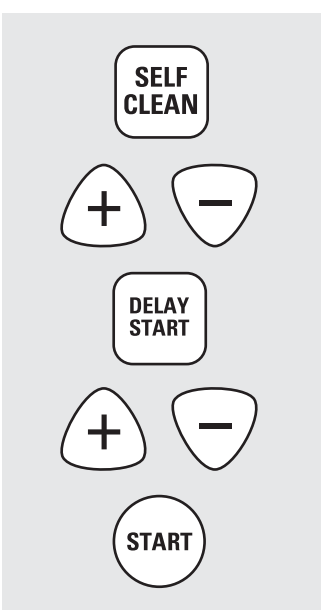

How to Delay the Start of Cleaning

Delay Start is setting the oven to start the clean cycle automatically at a later time than the present time of day.

NOTE: Before beginning, make sure the oven clock shows the correct time of day.

- 1 Touch the **SELF CLEAN** pad.
- 2 Touch the + or - pad to enter the desired clean time.
- 3 Touch the **DELAY START** pad. The earliest start time you can set will appear in the display.
- 4 Touch the + or - pad to enter the time of day you want the clean cycle to start.

- 5 Touch the **START** pad.

The door locks automatically. The display will show the start time. It will not be possible to open the oven door until the temperature drops below the lock temperature and the **LOCKED DOOR** light goes off.

When the **LOCKED DOOR** light is off, open the door.

NOTE:

- You can find out when the clean cycle will start by touching the **DELAY START** pad.

After a Clean Cycle

You may notice some white ash in the oven. Wipe it up with a damp cloth after the oven cools.

If white spots remain, remove them with a soap-filled scouring pad and rinse thoroughly with a vinegar and water mixture.

These deposits are usually a salt residue that cannot be removed by the clean cycle.

If the oven is not clean after one clean cycle, repeat the cycle.

NOTES:

- You cannot set the oven for cooking until the oven is cool enough for the door to unlock.
- While the oven is self-cleaning, you can touch the **CLOCK** pad to display the time of day. To return to the clean countdown, touch the **COOKING TIME** pad.
- If you have left the racks in the oven during the self-clean cycle and they become hard to slide, apply a small amount of vegetable oil or cooking oil to a paper towel and wipe the edges of the oven racks with the paper towel.

Care and cleaning of the oven.

Be sure electrical power is off and all surfaces are cool before cleaning any part of the oven.

How to Remove Protective Shipping Film and Packaging Tape

Carefully grasp a corner of the protective shipping film with your fingers and slowly peel it from the appliance surface. Do not use any sharp items to remove the film. Remove all of the film before using the appliance for the first time.

To assure no damage is done to the finish of the product, the safest way to remove the adhesive from packaging tape on new appliances is an application of a household liquid dishwashing detergent. Apply with a soft cloth and allow to soak.

NOTE: The adhesive must be removed from all parts. It cannot be removed if it is baked on.

Removable Storage Drawer

The storage drawer is a good place to store cookware and bakeware. Do not store plastics and flammable material in the drawer.

Do not overload the storage drawer. If the drawer is too heavy, it may slip off the track when opened. To open the drawer, grasp the center of the handle and pull straight out.

Most cleaning can be done with the drawer in place. However, the drawer may be removed if further cleaning is needed. Use soap and warm water to thoroughly clean.

To remove:

Pull the drawer straight out and lift over the guide stops.

To replace:

Lift over the guide stops and slide the drawer into place.

To clean both the inside and the outside:

Wipe with soap and water. Rinse well.

Do not use cleansing powders or harsh abrasives which may scratch the surface.

Oven Air Vents

Never block the vents (air openings) of the oven. They provide the air inlet and outlet that are necessary for the oven to operate properly with correct combustion.

Air openings are located under the control panel, above the door.



Care and cleaning of the oven.

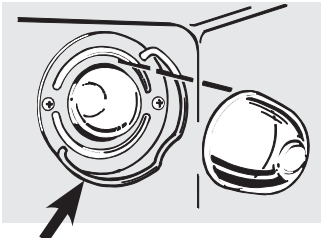

Wire cover holder

Oven Light Replacement

⚠ CAUTION: Before replacing your oven light bulb, disconnect the electrical power to the oven at the main fuse or circuit breaker panel. Be sure to let the light cover and bulb cool completely.

The oven light bulb is covered with a removable glass cover that is held in place with a bail-shaped wire. Remove the oven door, if desired, to reach the cover easily.

To remove:

- 1 Hold a hand under the cover so it doesn't fall when released. With fingers of the same hand, firmly push back the wire cover holder. Lift off the cover.

Do not remove any screws to remove the cover.

- 2 Do not touch hot bulb with a wet cloth. Replace bulb with a 40-watt household appliance bulb.

To replace cover:

- 1 Place it into the groove of the light receptacle. Pull the wire forward to the center of the cover until it snaps into place. When in place, the wire holds the cover firmly. Be certain the wire is in the depression in the center of the cover.
- 2 Connect electrical power to the oven.

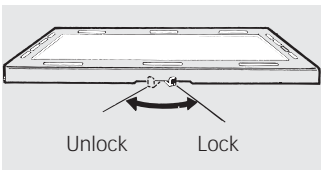

Removable Oven Bottom

The oven bottom can be removed to clean large spills, and to enable you to reach the oven burner. **Oven bottom must be replaced before using the self-clean cycle.**

To remove:

- 1 Slide the tab at the center front of the oven bottom to the left.
- 2 Lift the oven bottom up and out.

To replace:

- 1 Slip the oven bottom into the oven so the tabs in the rear of the oven bottom fit into the slots in the oven back.
- 2 Lower the front of the oven bottom into place and slide the front tab to the right to lock the oven bottom into place.

The oven bottom has a porcelain enamel finish.

To make cleaning easier, protect the oven bottom from excessive spillovers by placing a cookie sheet on the rack below the rack you are cooking on. This is particularly important when baking a fruit pie or other foods with a high acid content. Hot fruit fillings or other foods that are highly acidic (such as tomatoes, sauerkraut, and sauces with vinegar or lemon juice) may cause pitting and damage to the porcelain enamel surface and should be wiped up immediately.

We don't recommend using aluminum foil on the oven bottom. It can affect air flow if the holes are blocked and it can concentrate heat at the bottom of the oven, resulting in poor baking performance.

To clean up spillovers, use soap and water, an abrasive cleaner or soap-filled scouring pad. Rinse well to remove any soap before self-cleaning.

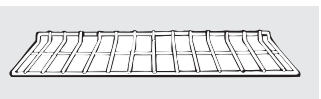

Oven Racks

Clean the oven racks with an abrasive cleanser or steel wool. After cleaning, rinse the racks with clean water and dry with a clean cloth.

NOTE: The shiny, silver-colored oven racks (on some models) may be cleaned in the self-cleaning oven. However, the racks will darken in color, lose their luster and become hard to slide if cleaned during the self-cleaning cycle.

To make the racks slide more easily, apply a small amount of vegetable oil or cooking oil to a paper towel and wipe the edges of the oven racks with the paper towel.

Control Panel

It's a good idea to wipe the control panel after each use of the oven. Clean with mild soap and water or vinegar and water, rinse with clean water and polish dry with a soft cloth.

Do not use abrasive cleansers, strong liquid cleaners, plastic scouring pads or oven cleaners on the control panel—they will damage the finish. A 50/50 solution of vinegar and hot water works well.

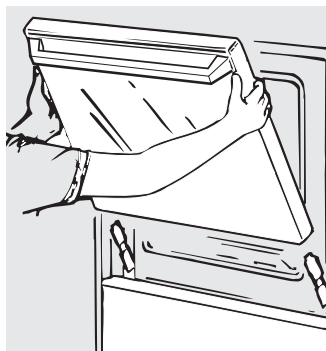

Lift the door straight up and off the hinges.

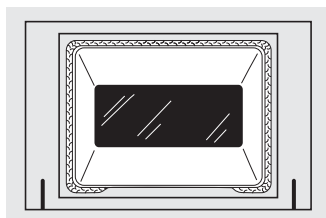

The gasket is designed with a gap at the bottom to allow for proper air circulation.

Do not rub or clean the door gasket—it has an extremely low resistance to abrasion.

If you notice the gasket becoming worn, frayed or damaged in any way or if it has become displaced on the door, you should have it replaced.

Lift-Off Oven Door

The oven door is removable, but it is heavy. You may need help removing and replacing the door. Do not lift the door by the handle. This can cause the glass to break or can cause damage to the door.

To remove the door, open it a few inches to the special stop position that will hold the door open. Grasp firmly on each side and lift the door straight up and off the hinges.

NOTES:

- Be careful not to place hands between the hinge and the oven door frame as the hinge could snap back and pinch fingers.
- While working in the oven area, cover the hinges with towels or empty paper towel rolls to prevent pinched fingers and chipping the porcelain enamel on the frame.

To replace the door, make sure the hinges are in the special stop position. Position the slots in the bottom of the door squarely over the hinges. Then lower the door slowly and evenly over both hinges at the same time. If the hinges snap back against the oven frame, pull them back out.

To clean the inside of the door:

- Do not allow excess water to run into any holes or slots in the door.
- Because the area inside the gasket is cleaned during the self clean cycle, you do not need to clean this by hand. Any soap left on the liner causes additional stains when the oven is heated.
- The area outside the gasket can be cleaned with a soap-filled plastic scouring pad.

To clean the outside of the door:

- Use soap and water to thoroughly clean the top, sides and front of the oven door. Rinse well. You may also use a glass cleaner to clean the glass on the outside of the door.
- Spillage of marinades, fruit juices, tomato sauces and basting materials containing acids may cause discoloration and should be wiped up immediately. When the surface is cool, clean and rinse.
- Do not use oven cleaners, cleansing powders or harsh abrasives on the outside of the door.

Stainless Steel Surfaces

Do not use a steel wool pad; it will scratch the surface.

To clean the stainless steel surface, use warm sudsy water or a stainless steel cleaner or polish. Always wipe the surface in the direction of the grain. Follow the cleaner instructions for cleaning the stainless steel surface.

To inquire about purchasing stainless steel appliance cleaner or polish, or to find the location of a dealer nearest you, please call our toll-free number:

National Parts Center 1.800.626.2002
GEAppliances.com

Care and cleaning of the oven.

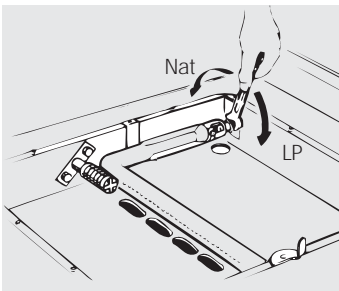

Adjusting Orifice Hoods

Check the inner cones of the flames. The inner cones of the flames should be about 1/2" long. If the flames are not right, use a 1/2" open-end wrench or adjustable joint pliers to adjust the orifice hood.

! WARNING: If you attempt to measure the inner cone of the flame, please use caution. Burns could result.

To shorten the cones, tighten the orifice hood by turning in the "LP" direction. To lengthen the cones, loosen the orifice hood by turning in the "Nat" direction.

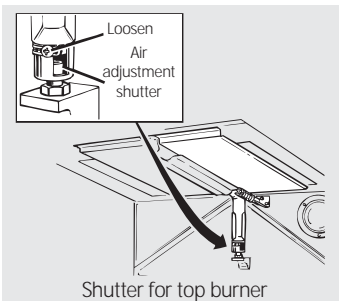

Broil and Oven Burner Air Adjustment Shutters

Air adjustment shutters for the broil and oven burners regulate the flow of air to the flame.

All ovens are factory adjusted for use with the natural gas used in most areas. But, since the gas in some areas may be different, you should check all adjustments described. If you are using LP gas, all the adjustments must be made.

Visually check the color of the flames every 6 months. If they look like illustration (A) in the *Troubleshooting Tips* in this guide, call for service.

When checking the flames, before and after adjustments, the oven door should be closed.

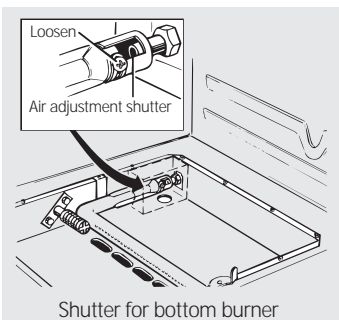

The air adjustment shutter for the top burner is in the center of the rear wall of the oven.

The shutter for the bottom burner is near the back wall. Remove the oven bottom for access.

Turn the burner full on and check the flames. The burner flames should not flutter or blow away from the burner. They should be blue in color with no trace of yellow. Foreign particles in the gas line may cause an orange flame at first, but this will soon disappear. If the flames are yellow or flutter, open the air shutter more. If they blow away from the burner, close the air shutter more. See the illustration in the *Troubleshooting Tips* of this guide for correct flame appearance.

To adjust the flow of air to either burner, loosen the Phillips head screw and rotate the shutter to allow more or less air into the burner tube as needed.

The flames for the top (broil) burner should burn steady with approximately 1" blue cones and should not extend out over the edges of the burner baffle.

To determine if the bottom burner flames are proper, remove the oven bottom and the burner baffle. The flames should have 1/2" to 3/4" blue cones with no yellow tipping. When the baffle is back in place, the flames will resettle.

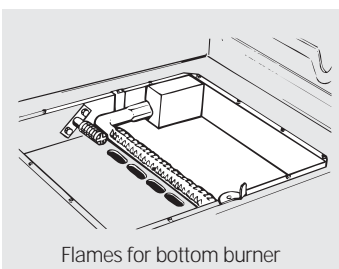
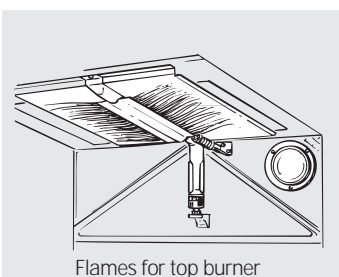



Troubleshooting Tips
 Save time and money! Review the charts on the following pages first and you may not need to call for service.

Problem	Possible Causes	What To Do
<i>Oven will not work</i>	Circuit breaker has been tripped or a fuse has blown.	<ul style="list-style-type: none"> Reset circuit breaker or replace fuse.
	Oven control not properly set.	<ul style="list-style-type: none"> Set the control according to this manual.
<i>Control signals after entering cooking time or start time</i>	You forgot to enter a bake temperature or cleaning time.	<ul style="list-style-type: none"> Touch the BAKE pad and desired temperature or the SELF CLEAN pad and desired clean time.
<i>There is moisture in the oven</i>	As your oven heats up, the changing temperature of the air in the oven may cause water droplets to form on the door glass.	<ul style="list-style-type: none"> These droplets are harmless and will evaporate as the oven continues to heat up.
<i>Food does not bake or roast properly</i>	Oven controls improperly set.	<ul style="list-style-type: none"> See the <i>Baking or Roasting</i> section.
	Rack position is incorrect.	<ul style="list-style-type: none"> See the <i>Baking</i> section.
	Oven thermostat needs adjustment.	<ul style="list-style-type: none"> See the <i>Adjust the oven thermostat—Do it yourself!</i> section.
	Clock not set correctly when timed cooking.	<ul style="list-style-type: none"> See the <i>Using the clock and timer</i> section.
	Aluminum foil used improperly in the oven.	<ul style="list-style-type: none"> See the <i>Baking or Roasting</i> section.
<i>Food does not broil properly</i>	Oven bottom not securely seated in position.	<ul style="list-style-type: none"> See the <i>Care and cleaning of the oven</i> section.
	Oven controls improperly set.	<ul style="list-style-type: none"> Make sure you touch the BROIL HI/LO pad.
	Oven door not closed.	<ul style="list-style-type: none"> See the <i>Broiling</i> section.
	Improper rack position being used.	<ul style="list-style-type: none"> See the <i>Broiling Guide</i>.
	Food being cooked in a hot pan.	<ul style="list-style-type: none"> For best results, use a pan designed for broiling. Make sure it is cool.
	Cookware not suited for broiling.	<ul style="list-style-type: none"> For best results, use a pan designed for broiling.
<i>Oven temperature too hot or too cold</i>	Oven thermostat needs adjustment.	<ul style="list-style-type: none"> See the <i>Adjust the oven thermostat—Do it yourself!</i> section.
<i>Clock and timer do not work</i>	A fuse in your home may be blown or the circuit breaker tripped.	<ul style="list-style-type: none"> Replace the fuse or reset the circuit breaker.
	Oven controls improperly set.	<ul style="list-style-type: none"> See the <i>Using the clock and timer</i> section.
<i>Oven light does not work</i>	Light bulb is loose or defective.	<ul style="list-style-type: none"> Tighten or replace the bulb.
	The pad operating the oven light is broken.	<ul style="list-style-type: none"> Call for service.

Before you call for service...



Troubleshooting Tips

<i>Problem</i>	<i>Possible Causes</i>	<i>What To Do</i>
<i>Oven will not self-clean</i>	The oven temperature is too high to set a self-clean operation.	<ul style="list-style-type: none"> Allow the oven to cool to room temperature and reset the controls.
	The oven door is not fully closed.	<ul style="list-style-type: none"> Close door.
	Oven controls improperly set.	<ul style="list-style-type: none"> See the <i>Using the self-cleaning oven</i> section.
<i>“Crackling” or “popping” sound</i>	This is the sound of the metal heating and cooling during both the cooking and cleaning functions.	<ul style="list-style-type: none"> This is normal.
<i>Excessive smoking</i>	Excessive soil.	<ul style="list-style-type: none"> Touch the CLEAR/OFF pad. Open the windows to rid the room of smoke. Wait until the LOCKED DOOR light goes off. Wipe up the excess soil and reset the clean cycle.
<i>Oven door will not open after a clean cycle</i>	Oven too hot.	<ul style="list-style-type: none"> Allow the oven to cool below locking temperature.
<i>Oven not clean after a clean cycle</i>	Oven controls improperly set.	<ul style="list-style-type: none"> See the <i>Using the self-cleaning oven</i> section.
	Oven was heavily soiled.	<ul style="list-style-type: none"> Clean up heavy spillovers before starting the clean cycle. Heavily soiled ovens may need to self-clean again or for a longer period of time.
<i>“LOCK DOOR” flashes in the display</i>	The self-clean cycle has been selected but the door is not closed.	<ul style="list-style-type: none"> Close the oven door.
<i>LOCKED DOOR light flashes in the display</i>	The oven door is locked because the temperature inside the oven has not dropped below the locking temperature.	<ul style="list-style-type: none"> Touch the CLEAR/OFF pad. Allow the oven to cool.
<i>“F—” and a number or letter flash in the display</i>	You have a function error code.	<ul style="list-style-type: none"> Touch the CLEAR/OFF pad. Allow the oven to cool for one hour. Put the oven back into operation.
	Function error code repeats.	<ul style="list-style-type: none"> Disconnect all power to the oven for 5 minutes and then reconnect power. If the function error code continues repeating, call for service.
<i>Display goes blank</i>	A fuse in your home may be blown or the circuit breaker tripped.	<ul style="list-style-type: none"> Replace the fuse or reset the circuit breaker.
	The clock is in the black-out mode.	<ul style="list-style-type: none"> See the <i>Special features of your oven control</i> section.
<i>Display flashes</i>	Power failure.	<ul style="list-style-type: none"> Reset the clock.
<i>Unable to get the display to show “SF”</i>	Oven control pads were not touched properly.	<ul style="list-style-type: none"> The BAKE and BROIL HI/LO pads must be touched at the same time and held for 2 seconds.

<i>Problem</i>	<i>Possible Causes</i>	<i>What To Do</i>
<i>Power outage, clock flashes</i>	Power outage or surge.	<ul style="list-style-type: none"> Reset the clock. If the oven was in use, you must reset it by touching the CLEAR/OFF pad, setting the clock and resetting any cooking function.
<i>"Burning" or "oily" odor emitting from the vent</i>	This is normal in a new oven and will disappear in time.	<ul style="list-style-type: none"> To speed the process, set a self-clean cycle for a minimum of 3 hours. See the <i>Using the self-cleaning oven</i> section.
<i>Strong odor</i>	Improper air/gas ratio in oven.	<ul style="list-style-type: none"> Adjust the oven burner air shutter.
	Insulation around the inside of the oven.	<ul style="list-style-type: none"> This is normal in a new oven, and will disappear in time.
<i>Fan noise</i>	A cooling fan may turn on and off automatically.	<ul style="list-style-type: none"> This is normal. The fan will run until the function is over or the door is opened.
<i>Cannot see flames on both sides of broil burner</i>	Bright glow of igniter makes flames difficult to see.	<ul style="list-style-type: none"> See the <i>Broiling</i> section.
<i>Burners have yellow or yellow-tipped flames</i>	Combustion quality of burner flames needs to be determined visually.	<ul style="list-style-type: none"> Use the illustrations below to determine if your burner flames are normal. If burner flames look like A, call for service. Normal burner flames should look like B or C, depending on the type of gas you use. With LP gas, some yellow tipping on outer cones is normal.



A–Yellow flames
Call for service



B–Yellow tips on outer cones
Normal for LP gas



C–Soft blue flames
Normal for natural gas



Looking For Something More?

You can find these accessories and many more at GEAppliances.com (U.S.) or www.GEAppliances.ca (Canada), or call 800.626.2002 (U.S.) or 800.661.1616 (Canada) (during normal business hours). Have your model number ready.

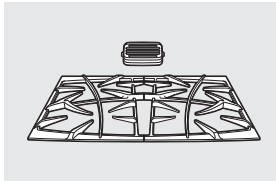

Grates

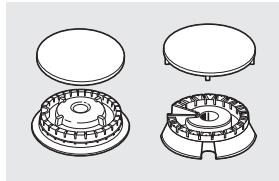

Surface Burner Heads and Caps

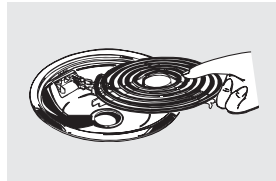

Surface Elements and Drip Pans



Knobs

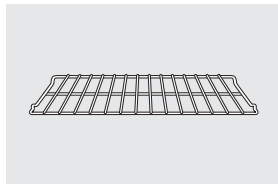

Oven Racks

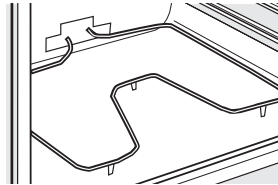

Oven Elements

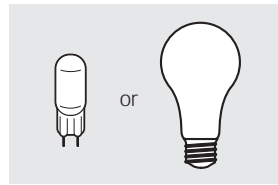

Light Bulbs

Experience these other great products to keep your kitchen looking great!



Ceramic Cooktop Cleaning Kit: Includes cleaner, scraper and pad

WX10X117GCS



Ceramic Cooktop Cleaning Wipes

WX10X305



Stainless Steel Appliance Polish Wipes

WX10X10001



Stainless Steel Appliance Cleaner

PM10X311

Get the most out of your Broiler Pan! (Not for use with Broiler Drawer models.)

Use your pan and grid cover to broil hamburgers, seafood, steaks, vegetables, bacon, chops and so much more! The pan below catches the excess fats and oils.

- Genuine GE Part
- Easy To Clean
- One-Year Warranty

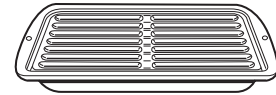

Limited Time Offer! Free Shipping!

When you order your broiler pan *within 30 days* of purchasing your GE cooking product.

	Small	Large*	XL**
U.S. Part #	WB48X10055	WB48X10056	WB48X10057
Canada Part #	222D2097G001	222D2097G002	N/A
Dimensions	8-3/4" W x 1-1/4" H x 13-1/2" D	12-3/4" W x 1-1/4" H x 16-1/2" D	17" W x 1-1/4" H x 19-1/4" D
Price	US\$10.50†	US\$14.50†	US\$16.75†

† Plus applicable state sales tax (PST/HST and GST)

* The large (standard) broil pan does not fit in 20"/24" ranges.

** The XL pan does not fit in 24" wall ovens, 27" drop-ins or 20"/24" ranges.

To place your order, call 800.626.2002 (U.S.), 800.661.1616 (Canada) or mail this form to:

In the U.S.: GE Parts, P.O. Box 221027, Memphis, TN 38122-1027. In Canada: GE Parts, 1 Factory Lane, Moncton, N.B. E1C 9M3

Broiler Pan Order Form

Quantity _____ Part Number _____

Model Number _____ Serial Number _____ Brand _____ Date of Purchase _____

First Name _____ Last Name _____

Address _____

City _____ State _____ Zip Code _____

Phone _____ E-Mail _____

Credit Card _____ Check _____ Money Order _____

Visa _____ MasterCard _____ Discover _____ AmEx _____ Credit Card # _____

Exp. Date: Month _____ Year _____ Signature: _____

GE Gas Oven Warranty.



All warranty service provided by our Factory Service Centers, or an authorized Customer Care® technician. To schedule service on-line, visit us at GEAppliances.com, or call 800.GE.CARES (800.432.2737). Please have serial number and model number available when calling for service.

Staple your receipt here. Proof of the original purchase date is needed to obtain service under the warranty.

For The Period Of: *GE Will Replace, At No Charge To You:*

One Year

From the date of the original purchase

Any part of the oven which fails due to a defect in materials or workmanship. During this **limited one-year warranty**, GE will also provide, **free of charge**, all labor and in-home service to replace the defective part.

What GE Will Not Cover:

- Service trips to your home to teach you how to use the product.
- Improper installation, delivery or maintenance.
- Failure of the product if it is abused, misused, or used for other than the intended purpose or used commercially.
- Replacement of house fuses or resetting of circuit breakers.
- Damage to the product caused by accident, fire, floods or acts of God.
- Incidental or consequential damage to personal property caused by possible defects with this appliance.
- Damage caused after delivery.
- Product not accessible to provide required service.
- Service to repair or replace light bulbs, except for LED lamps.

EXCLUSION OF IMPLIED WARRANTIES—Your sole and exclusive remedy is product repair as provided in this Limited Warranty. Any implied warranties, including the implied warranties of merchantability or fitness for a particular purpose, are limited to one year or the shortest period allowed by law.

This warranty is extended to the original purchaser and any succeeding owner for products purchased for home use within the USA. If the product is located in an area where service by a GE Authorized Servicer is not available, you may be responsible for a trip charge or you may be required to bring the product to an Authorized GE Service location for service. In Alaska, the warranty excludes the cost of shipping or service calls to your home.

Some states do not allow the exclusion or limitation of incidental or consequential damages. This warranty gives you specific legal rights, and you may also have other rights which vary from state to state. To know what your legal rights are, consult your local or state consumer affairs office or your state's Attorney General.

Warrantor: General Electric Company. Louisville, KY 40225

Consumer Support.



GE Appliances Website

GEAppliances.com

Have a question or need assistance with your appliance? Try the GE Appliances Website 24 hours a day, any day of the year! For greater convenience and faster service, you can now download Owner's Manuals, order parts or even schedule service on-line.



Schedule Service

GEAppliances.com

Expert GE repair service is only one step away from your door. Get on-line and schedule your service at your convenience any day of the year! Or call 800.GE.CARES (800.432.2737) during normal business hours.



Real Life Design Studio

GEAppliances.com

GE supports the Universal Design concept—products, services and environments that can be used by people of all ages, sizes and capabilities. We recognize the need to design for a wide range of physical and mental abilities and impairments. For details of GE's Universal Design applications, including kitchen design ideas for people with disabilities, check out our Website today. For the hearing impaired, please call 800.TDD.GEAC (800.833.4322).



Extended Warranties

GEAppliances.com

Purchase a GE extended warranty and learn about special discounts that are available while your warranty is still in effect. You can purchase it on-line anytime, or call 800.626.2224 during normal business hours. GE Consumer Home Services will still be there after your warranty expires.

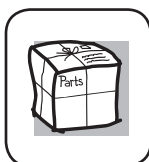

Parts and Accessories

GEAppliances.com

Individuals qualified to service their own appliances can have parts or accessories sent directly to their homes (VISA, MasterCard and Discover cards are accepted). Order on-line today, 24 hours every day or by phone at 800.626.2002 during normal business hours.

Instructions contained in this manual cover procedures to be performed by any user. Other servicing generally should be referred to qualified service personnel. Caution must be exercised, since improper servicing may cause unsafe operation.



Contact Us

GEAppliances.com

If you are not satisfied with the service you receive from GE, contact us on our Website with all the details including your phone number, or write to: General Manager, Customer Relations
GE Appliances, Appliance Park
Louisville, KY 40225



Register Your Appliance

GEAppliances.com

Register your new appliance on-line—at your convenience! Timely product registration will allow for enhanced communication and prompt service under the terms of your warranty, should the need arise. You may also mail in the pre-printed registration card included in the packing material.