



# Double Oven Gas RANGES

**SAFETY INFORMATION** ..... 2

**WARRANTY**..... 7

**ASSISTANCE / ACCESSORIES**... 8

**USING THE COOKTOP**

In Case of a Power Failure ..... 9

Surface Burners ..... 9

Griddle ..... 11

**USING THE OVEN**

Oven Controls.....14

Special Features.....16

Sabbath Mode.....17

Cookware Guidelines.....18

Cooking Modes.....18

Oven Racks .....19

Oven Air Vents .....19

Cooking Guide ..... 20

Aluminum Foil and Oven Liners.....21

**CARE AND CLEANING**

Cleaning the Oven ..... 22

Cleaning The Cooktop..... 23

Cleaning the Door ..... 27

Maintenance ..... 28

**TROUBLESHOOTING TIPS**..... 30

**OWNER'S MANUAL**

Write the model and serial numbers here:

Model # \_\_\_\_\_

Serial # \_\_\_\_\_

You can find the rating label on a metal flag behind the rear control panel. From the front of the range, reach behind the middle of the rear control panel and rotate the rating label up.

**ESPAÑOL**

Para consultar una version en español de este manual de instrucciones, visite nuestro sitio de internet [GEAppliances.com](http://GEAppliances.com).

# IMPORTANT SAFETY INFORMATION

## READ ALL INSTRUCTIONS BEFORE USING

**⚠ WARNING** If the information in this manual is not followed exactly, a fire or explosion may result, causing property damage, personal injury or death.

- Do not store or use gasoline or other flammable vapors and liquids in the vicinity of this or any other appliance.
- **WHAT TO DO IF YOU SMELL GAS**
  - Do not try to light any appliance.
  - Do not touch any electrical switch; do not use any phone in your building.
  - Immediately call your gas supplier from a neighbor's phone. Follow the gas supplier's instructions.
  - If you cannot reach your gas supplier, call the fire department.
- Installation and service must be performed by a qualified installer, service agency or the gas supplier.

## ANTI-TIP DEVICE



### ⚠ WARNING

#### Tip-Over Hazard

A child or adult can tip the range and be killed. Verify the anti-tip bracket has been properly installed and engaged. Ensure the anti-tip bracket is re-engaged when the range is moved. Do not operate the range without the anti-tip bracket in place and engaged. Failure to follow these instructions can result in death or serious burns to children or adults.

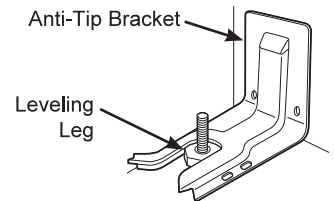

To reduce the risk of tipping the range, the range must be secured by a properly installed anti-tip bracket. See installation instructions

shipped with the bracket for complete details before attempting to install.

To check if the bracket is installed and engaged properly, look underneath the range to see that the rear leveling leg is engaged in the bracket. On some models, the storage drawer or kick panel can be removed for easy inspection. If visual inspection is not possible, slide the range forward, confirm the anti-tip bracket is securely attached to the floor or wall, and slide the range back so the rear leveling leg is under the anti-tip bracket.

If your range is removed for cleaning, servicing or any reason, be sure the anti-tip device is reengaged properly when the range is replaced. Failure to take this precaution could result in tipping of the range and can result in death or serious burns to children or adults.

Never completely remove the leveling legs or the range will not be secured to the anti-tip device properly.

## READ AND SAVE THESE INSTRUCTIONS

**STATE OF CALIFORNIA PROPOSITION 65 WARNINGS****▲ WARNING**

This product contains one or more chemicals known to the State of California to cause cancer, and birth defects or other reproductive harm.

Gas appliances can cause low-level exposure to some of these substances, including benzene, carbon monoxide, formaldehyde and soot, caused primarily by incomplete combustion of natural gas or propane fuels. Exposure to these substances can be minimized by opening a window or using a ventilation fan or hood.

**▲ WARNING****GENERAL SAFETY INSTRUCTIONS****▲ WARNING**

**NEVER use this appliance as a space heater to heat or warm the room. Doing so may result in carbon monoxide poisoning and overheating of the oven.**

- Use this appliance for its intended purpose as described in this owner's manual.
- Have your range installed and properly grounded by a qualified installer in accordance with the provided installation instructions.
- Any adjustment and service should be performed only by a qualified gas range installer or service technician. Do not attempt to repair or replace any part of your range unless it is specifically recommended in this manual.
- Your range is shipped from the factory set for use with natural gas. It can be converted for use with propane gas. If required, these adjustments must be made by a qualified technician in accordance with the installation instructions and local codes. The agency performing this work assumes responsibility for the conversion.
- Have the installer show you the location of the range gas shut-off valve and how to turn it off if necessary.
- Plug your range into a 120-volt grounded outlet only. Do not remove the round grounding prong from the plug. If in doubt about the grounding of the home electrical system, it is your responsibility and obligation to have an ungrounded outlet replaced with a properly grounded, three prong outlet in accordance with the National Electrical Code. Do not use an extension cord with this appliance.
- Before performing any service, unplug the range or disconnect the power supply at the household distribution panel by removing the fuse or switching off the circuit breaker.
- Be sure all packing materials are removed from the range before operating to prevent ignition of these materials.
- Avoid scratching or impacting glass doors, cooktops, or control panels. Doing so may lead to glass breakage. Do not cook on a product with broken glass. Shock, fire, or cuts may occur.
- Do not leave children alone or unattended in an area where an appliance is in use. They should never be allowed to climb, sit or stand on any part of the appliance.
- **▲ CAUTION** Do not store items of interest to children in cabinets above an oven - children climbing on the oven to reach items could be seriously injured.

**READ AND SAVE THESE INSTRUCTIONS**

# IMPORTANT SAFETY INFORMATION

## READ ALL INSTRUCTIONS BEFORE USING

### **▲ WARNING** GENERAL SAFETY INSTRUCTIONS (CONT.)

- Never block the vents (air openings) of the range. They provide the air inlets and outlets that are necessary for the range to operate properly with correct combustion. Air openings are located at the rear of the cooktop, at the top and bottom of the oven door, and at the bottom of the range under the warming drawer, lower oven drawer or kick panel.
- Use only dry pot holders—moist or damp pot holders on hot surfaces may result in burns from steam. Do not let pot holders touch surface burners, burner grate, or oven heating element. Do not use a towel or other bulky cloth in place of pot holders.
- Do not touch the heating elements or the interior surface of the oven. These surfaces may be hot enough to burn even though they are dark in color. During and after use, do not touch, or let clothing or other flammable materials contact any interior area of the oven; allow sufficient time for cooling first. Other surfaces of the appliance may become hot enough to cause burns. Potentially hot surfaces include the burners, grates, oven vent opening, surfaces near the opening, and crevices around the oven door.
- Do not heat unopened food containers. Pressure could build up and the container could burst, causing an injury.
- Cook food thoroughly to help protect against foodborne illness. Minimum safe food temperature recommendations can be found at [www.IsItDoneYet.gov](http://www.IsItDoneYet.gov) and [www.fsis.usda.gov](http://www.fsis.usda.gov). Use a food thermometer to take food temperatures and check several locations.
- Do not allow anyone to climb, stand or hang on the oven door, drawer or cooktop. They could damage the range or tip it over causing severe injury or death.

### **▲ WARNING** KEEP FLAMMABLE MATERIALS AWAY FROM THE OVEN

Failure to do so may result in fire or personal injury.

- Do not store or use flammable materials in an oven or near the cooktop, including paper, plastic, pot holders, linens, wall coverings, curtains, drapes and gasoline or other flammable vapors and liquids.
- Never wear loose-fitting or hanging garments while using the appliance. These garments may ignite if they contact hot surfaces causing severe burns.
- Do not let cooking grease or other flammable materials accumulate in or near the range. Grease in the oven or on the cooktop may ignite.

### **▲ WARNING** IN THE EVENT OF A FIRE, TAKE THE FOLLOWING STEPS TO PREVENT INJURY AND FIRE SPREADING

- Do not use water on grease fires. Never pick up a flaming pan. Turn the controls off. Smother a flaming pan on a surface burner by covering the pan completely with a well-fitting lid, cookie sheet, or flat tray. If necessary, use a multi-purpose dry chemical or foam-type fire extinguisher.
- If there is a fire in the oven during baking, smother the fire by closing the oven door and turning the oven off or by using a multi-purpose dry chemical or foam type fire extinguisher.
- If there is a fire in the oven during self-clean, turn the oven off and wait for the fire to go out. Do not force the door open. Introduction of fresh air at self-clean temperatures may lead to a burst of flame from the oven.

## READ AND SAVE THESE INSTRUCTIONS

## **▲ WARNING** COOKTOP SAFETY INSTRUCTIONS

- Never leave the surface burners unattended at medium or high heat settings. Foods, especially oily foods, may ignite resulting in fire that could spread to surrounding cabinets.
- Never leave oil unattended while frying. If allowed to heat beyond its smoking point, oil may ignite resulting in fire that may spread to surrounding cabinets. Use a deep fat thermometer whenever possible to monitor oil temperature.
- To avoid oil spillover and fire, use the minimum amount of oil when using a shallow pan-frying and avoid cooking frozen foods with excessive amounts of ice.
- Use proper pan size and avoid pans that are unstable or easily tipped. Select cookware that is matched to the size of the burner. Burner flames should be adjusted so that they do not extend beyond the bottom of the pan. Excessive flame may be hazardous.
- Always use the LITE position when igniting the top burners and make sure the burners have ignited.
- When using glass/ceramic cookware, make sure it is suitable for cooktop service; others may break because of sudden change in temperature.
- To minimize the possibility of burns, ignition of flammable materials and spillage, the handle of a container should be turned toward the center of the range without extending over nearby burners.
- Do not use a wok with a round metal support ring. The ring may trap heat and block air to the burner resulting in a carbon monoxide hazard.
- Do not attempt to lift the cooktop. Doing so may damage the gas tubing to the surface burners resulting in a gas leak and risk of fire.
- When disabling Lock Control (on some models), make sure the surface controls are set to the OFF position. This will prevent unintended gas flow from the burners.
- Do not use aluminum foil to cover the grates or line any part of the cooktop. Doing so may result in carbon monoxide poisoning, overheating of the cooktop surfaces, or a potential fire hazard.

## **▲ WARNING** OVEN SAFETY INSTRUCTIONS

**▲ WARNING** NEVER cover any slots, holes, or passages in the oven bottom or cover an entire rack with materials such as aluminum foil or oven liners. Doing so blocks air flow through the oven and may cause carbon monoxide poisoning. Never place foil or oven liners on the oven bottom. They can trap heat causing risk of smoke or fire.

- Stand away from the range when opening the oven door. Hot air or steam which escapes can cause burns to hands, face and/or eyes.
- Never place cooking utensils, pizza or baking stones, or any type of foil or liner on the oven floor. These items can trap heat or melt, resulting in damage to the product and risk of shock, smoke or fire.
- Place oven racks in desired location while oven is cool. If rack must be moved while oven is hot, be careful to avoid touching hot surfaces.
- Do not leave items such as paper, cooking utensils, or food in the oven when not in use. Items stored in an oven can ignite.
- Do not leave items on the cooktop near the oven vent. Items may overheat resulting in a risk of fire or burns.
- Never broil with door open. Open-door broiling is not permitted due to overheating of control knobs.

# READ AND SAVE THESE INSTRUCTIONS

# IMPORTANT SAFETY INFORMATION

## READ ALL INSTRUCTIONS BEFORE USING

---

### **▲ WARNING** SELF-CLEANING OVEN SAFETY INSTRUCTIONS (on some models)

---

The self-cleaning feature operates the oven at temperatures high enough to burn away food soils in the oven. Follow these instructions for safe operation.

- Do not touch oven surfaces during self-clean operation. Keep children away from the oven during self-cleaning. Failure to follow these instructions may cause burns.
- Before operating the self-clean cycle, remove pans, shiny metal oven racks, and other utensils from the oven. Only porcelain-coated oven racks may be left in the oven.
- Before operating the self-clean cycle, wipe grease and food soils from the oven. Excessive amount of grease may ignite leading to smoke damage to your home.
- If the self-cleaning mode malfunctions, turn the oven off and disconnect the power supply. Have it serviced by a qualified technician.
- Do not use oven cleaners. No commercial oven cleaner or oven liner protective coating of any kind should be used in or around any part of the oven.
- Do not clean the door gasket. The door gasket is essential for a good seal. Care should be taken not to rub, damage or move the gasket.
- **IMPORTANT:** The health of some birds is extremely sensitive to the fumes given off during the self-cleaning cycle of any range. Move birds to another well-ventilated room.

## READ AND SAVE THESE INSTRUCTIONS



# Thank You! ... for your purchase of a GE Appliances Brand appliance.

**WARRANTY**

**Register Your Appliance:** Register your new appliance online at your convenience!

[www.geappliances.com/service\\_and\\_support/register/](http://www.geappliances.com/service_and_support/register/)

Timely product registration will allow for enhanced communication and prompt service under the terms of your warranty, should the need arise. You may also mail in the pre-printed registration card included in the packing material.

## GE Appliances Gas Range Warranty

### GEAppliances.com

All warranty service is provided by our Factory Service Centers, or an authorized Customer Care® technician. To schedule service online, visit us at [www.geappliances.com/service\\_and\\_support/](http://www.geappliances.com/service_and_support/), or call GE Appliances at 800.GE.CARES (800.432.2737). Please have your serial number and your model number available when calling for service.

Servicing your appliance may require the use of the onboard data port for diagnostics. This gives a GE Appliances factory service technician the ability to quickly diagnose any issues with your appliance and helps GE Appliances improve its products by providing GE Appliances with information on your appliance. If you do not want your appliance data to be sent to GE Appliances, please advise your technician not to submit the data to GE Appliances at the time of service.

For the period of	GE Appliances will replace
<b>One year</b> From the date of the original purchase	<b>Any part</b> of the range which fails due to a defect in materials or workmanship. During this <b>limited one-year warranty</b> , GE Appliances will provide, <b>free of charge</b> , all labor and in-home service to replace the defective part.

### What GE Appliances will not cover:

- Service trips to your home to teach you how to use the product.
- Improper installation, delivery, or maintenance.
- Failure of the product if it is abused, misused, modified, or used for other than the intended purpose or used commercially.
- Replacement of house fuses or resetting of circuit breakers.
- Damage to the product caused by accident, fire, floods, or acts of God.
- Damage to finish, such as surface rust, tarnish, or small blemishes not reported within 48 hours of delivery.
- Incidental or consequential damage caused by possible defects with this appliance.
- Damage caused after delivery.
- Product not accessible to provide required service.
- Service to repair or replace light bulbs, except for LED lamps.

### EXCLUSION OF IMPLIED WARRANTIES

Your sole and exclusive remedy is product repair as provided in this Limited Warranty. Any implied warranties, including the implied warranties of merchantability or fitness for a particular purpose, are limited to one year or the shortest period allowed by law.

This warranty is extended to the original purchaser and any succeeding owner for products purchased for home use within the USA. If the product is located in an area where service by a GE Appliances Authorized Servicer is not available, you may be responsible for a trip charge or you may be required to bring the product to an Authorized GE Appliances Service location for service. In Alaska, the warranty excludes the cost of shipping or service calls to your home. Some states do not allow the exclusion or limitation of incidental or consequential damages. This warranty gives you specific legal rights, and you may also have other rights which vary from state to state. To know what your legal rights are, consult your local or state consumer affairs office or your state's Attorney General.

### Warrantor: GE Appliances

**Extended Warranties:** Purchase a GE Appliances extended warranty and learn about special discounts that are available while your warranty is still in effect. You can purchase it online anytime at

[www.geappliances.com/service\\_and\\_support/shop-for-extended-service-plans.htm](http://www.geappliances.com/service_and_support/shop-for-extended-service-plans.htm)

or call 800.626.2224 during normal business hours. GE Appliances Service will still be there after your warranty expires.

Staple your receipt here. Proof of the original purchase date is needed to obtain service under the warranty.

# Have a question or need assistance with your appliance?

Try the GE Appliances Website ([www.geappliances.com/service\\_and\\_support/](http://www.geappliances.com/service_and_support/)) 24 hours a day, any day of the year! For greater convenience and faster service, you can now download Owner's Manuals, order parts or even schedule service on-line.

**Schedule Service:** Expert GE Appliances repair service is only one step away from your door. Get on-line and schedule your service at [www.geappliances.com/service\\_and\\_support/](http://www.geappliances.com/service_and_support/) or call GE Appliances at 800.GE.CARES (800.432.2737) during normal business hours.

**Parts and Accessories:** Individuals qualified to service their own appliances can have parts or accessories sent directly to their homes (VISA, MasterCard and Discover cards are accepted). Order on-line today, 24 hours every day or by phone at 800.626.2002 during normal business hours.

Instructions contained in this manual cover procedures to be performed by any user. Other servicing generally should be referred to qualified service personnel. Caution must be exercised, since improper servicing may cause unsafe operation.

**Real Life Design Studio:** GE Appliances supports the Universal Design concept of products, services and environments that can be used by people of all ages, sizes and capabilities. We recognize the need to design for a wide range of physical and mental abilities and impairments. For details of GE Appliances' Universal Design applications, including kitchen design ideas for people with disabilities, check out our Website today. For the hearing impaired, please call 800.TDD.GEAC (800.833.4322).

**Contact Us:** If you are not satisfied with the service you receive from GE Appliances, contact us on our Website with all the details including your phone number, or write to:

**General Manager, Customer Relations  
GE Appliances, Appliance Park Louisville, KY 40225**

## Accessories

### Looking For Something More?

**GE Appliances offers a variety of accessories to improve your cooking and maintenance experiences!**

To place an order visit us online at:

[www.GEApplianceParts.com](http://www.GEApplianceParts.com) (U.S.) or [www.GEAppliances.ca](http://www.GEAppliances.ca) (Canada)  
or call **800.626.2002** (U.S.) **800.661.1616** (Canada)

The following products and more are available:

### Accessories

Nickel Flat Rack	WB48X20249
Reinforced Nickel Flat Rack	WB48X20783
Self Clean Flat Rack	WB48X21508
Nickel Extension Rack	WB39X10040
Self Clean Extension Rack	WB48X21543
Broiler Pan (12 3/4" x 1 1/4" x 16 1/2")	WB48X10056G
Roasting Rack Accessory	WB48X5108
Cooktop Center Grate	WB31X24737
Nonstick Aluminum Griddle	WB31X24738
Reversible Cast-Iron Griddle	WB31X24998

### Cleaning Supplies

CitruShine Stainless Steel Wipes	WX10X10007
Stainless Steel Polishing Cloth	WX10X307
Cerama Bryte® Burnt-On Grease Remover	WX10X320

## Removing Protective Shipping Film and Packaging Tape

**NOTE:** Remove all protective packing before operating the range.

Carefully grasp a corner of the protective shipping film with your fingers and slowly peel it from the appliance surface. Do not use any sharp items to remove the film. If adhesive residue remains, remove it by applying dish soap and water with a soft cloth.



# In Case of a Power Failure

In the event of a power failure, the oven is inoperable and no attempt should be made to operate it. However, the surface burners may be lit with a match. Using extreme caution, hold a lit match near the ports beneath

the surface burner cap, then slowly turn the knob to the LITE position. Once lit, surface burners will continue to operate normally.

## Surface Burners

### Lighting a Surface Burner

**▲ WARNING** Burners should be operated only when covered by cookware. Burner flames not covered by cookware present a risk of fire or clothing ignition. Never let flames extend beyond the sides of the cookware. Failure to comply may result in serious injury.

Make sure all burners are in their correct locations and fully assembled before attempting to operate any burner.

Select a burner and find its control knob. Push the knob in and turn it to the LITE position.

You will hear a clicking noise—the sound of the electric spark igniting the burner. When one burner is turned to LITE, all burners will spark. Sparking will continue as long as the knob remains at LITE. Once gas is ignited, turn the knob to adjust the flame size.

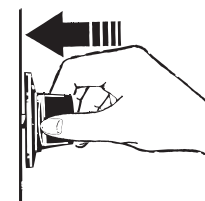

Push the control knob in and turn it to the LITE position.

### Selecting a Flame Size

Watch the flame, not the knob, as you adjust heat. When rapid heating is desired, the flame size should match the size of the cookware you are using. Flames larger than the bottom of the cookware will not heat faster and may be hazardous.

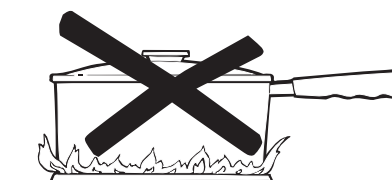

These flames are too large for the pot

### Using the Surface Burners

**NOTES:**

- Do not operate the burner for an extended period of time without cookware on the grate. The finish on the grate may discolor or chip without cookware to absorb the heat.
- Do not attempt to disassemble any burner while another burner is on. Damage to the product may occur.
- Be sure the burners and grates are cool before you place your hand, a pot holder or cleaning materials on them.

Your rangetop has sealed gas burners that offer convenience, cleanability and flexibility for a wide range of cooking applications.

The smallest burner is the simmer burner. A simmer burner turned down to LO provides precise cooking performance for foods such as delicate sauces that require low heat for a long cooking time.

The extra-large burner is designed to quickly bring large amounts of liquid to a boil. Some models have a POWER BOIL™ setting especially designed for use with cookware with a diameter of 11 inches or larger.

### Types of Surface Burners

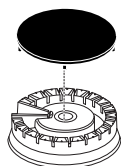

**Round Burner**

Use this burner for general cooking purposes. Size cookware appropriately to the flames.



**Oval Burner (on some models)**

Use this burner to cook on the griddle.



**Tri-Ring Burner (on some models)**

Use this burner for large cookware or for simmering applications.



**Dual Oval Burner (on some models)**

Use this burner to cook on the griddle or with small cookware.

## Surface Burners (Cont.)

### Tri-Ring Burner (some models)

For large cookware, activate all rings by setting the burner between Hi and Med.

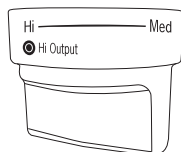

Side View Of The Tri-Ring Burner Knob

For small cookware or low heating applications, only activate the inner rings by setting the burner between Lo and Sim.

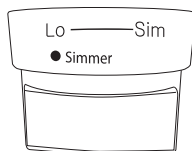

### Dual Oval Burner (some models)

For small cookware, only activate the round burner.

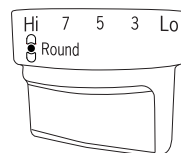

Side View Of The Dual Oval Burner Knob

When using a griddle, activate both the oval and round burner sections.

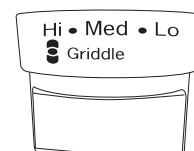

### Top-of-Range Cookware

**Aluminum:** Medium-weight cookware is recommended because it heats quickly and evenly. Most foods brown evenly in an aluminum skillet. Use saucepans with tight-fitting lids when cooking with minimum amounts of water.

**Stainless Steel:** This metal alone has poor heating properties and is usually combined with copper, aluminum or other metals for improved heat distribution. Combination metal skillets usually work satisfactorily if they are used with medium heat or as the manufacturer recommends.

**Cast-Iron:** If heated slowly, most skillets will give satisfactory results.

**Enamelware:** Under some conditions, the enamel of some cookware may melt. Follow the cookware manufacturer's recommendations for cooking methods.

**Glass:** There are two types of glass cookware—those for oven use only and those for top-of-range cooking (saucepans, coffee and teapots). Glass conducts heat very slowly.

**Heatproof Glass Ceramic:** Can be used for either surface or oven cooking. It conducts heat very slowly and cools very slowly. Check the cookware manufacturer's directions to be sure it can be used on gas ranges.

### Stove Top Grills

Do not use an after-market stove top grill on your gas surface burners. A stove top grill will cause incomplete combustion resulting in carbon monoxide levels above allowable standards. This could be hazardous to your health.



Do not use stove top grills

### Using a Wok

Use only a flat-bottomed wok with a diameter of 14 inches or less. Make sure the wok bottom sits flat on the grate.

Do not use a wok support ring. Placing the ring over the burner or grate may cause the burner to work improperly, resulting in carbon monoxide levels above allowable standards. This could be hazardous to your health.



Use a flat-bottomed wok.



## Griddle (on some models)

### **▲ WARNING** Fire Hazard

- Use care when cooking greasy foods. Spilled grease may result in fire.
- Never place any items on the griddle when it is not in use. Heat from surrounding burners can heat the griddle and may result in fire.
- Place and remove the griddle only when griddle is cool and all surface burners are turned OFF.

### Positioning Your Griddle

The reversible cast-iron griddle (on some models) and the nonstick aluminum griddle (on some models) can only be used over the center burner of the rangetop. To position the griddle, remove the center grate (if present), and replace it with the griddle. Do not turn on the center burner until you are certain the griddle has been positioned correctly.

### Preheating Your Griddle

If your center burner is a single oval burner, preheat your griddle for 2-5 minutes on Hi before placing food on the griddle. If your center burner is a dual oval burner, preheat your griddle for 5-10 minutes on Hi before placing food on the griddle. Once the griddle is preheated, turn the heat down to the cook setting outlined in the table corresponding to your griddle. To determine the type of burner you have, see the Types of Surface Burners section.

### Using Your Reversible Cast-Iron Griddle (on some models)

The ribbed side of the reversible griddle can be used for food normally grilled.

Your griddle provides an extra-large cooking surface for meats, pancakes and other foods usually prepared in a skillet. Before first use, rinse with hot water and dry thoroughly. Prepare the surface with cooking spray or vegetable oil.

#### Griddle Precautions:

- Do not place the griddle in a microwave oven.
- Do not clean your griddle in the dishwasher.
- If something has spilled under the griddle, it should be cleaned up as soon as possible to prevent “baked on” food soil.
- Do not allow grease to accumulate under the griddle as it can be a fire hazard. Clean under the griddle with hot, soapy water as soon as it is cool.

#### Preseasoned Reversible Cast-Iron Griddle

Type of Food	Cook Setting
Bacon	Med
Breakfast Sausage Links	Med
Eggs	Lo
Grilled Cheese	Med-Lo
Hamburgers	Med-Lo
Pancakes	Med-Lo
Warming Tortillas	Lo

Cook settings may need to be reduced if the griddle is used for an extended time.

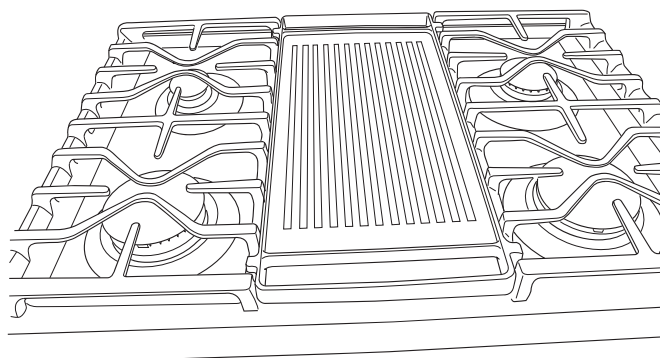

Replace the center grate (if present) with the Preseasoned Cast-Iron Reversible Griddle

## Griddle (on some models) (Cont.)

### Using Your Nonstick Aluminum Griddle (on some models)

Your griddle provides an extra-large cooking surface for meats, pancakes, and other foods usually prepared in a skillet. Before first use, rinse with hot water and dry thoroughly.

#### Griddle Precautions:

- Do not use oil on the griddle for extended lengths of time. Permanent staining and/or craze lines on the surface could result.
- **Do not overheat the griddle.** Leaving the griddle burner on at Hi for an extended amount of time without food can damage the nonstick coating.
- Use only plastic, nylon, wooden utensils, or SilverStone® kitchen tools to prevent marring of the coating.
- Never use knives or cut food on the griddle.
- Do not use metal utensils with sharp points or rough, sharp edges which might damage the griddle surface.
- Store carefully to prevent scratching.
- Do not place the griddle in a microwave oven.
- If something has spilled under the griddle, it should be cleaned up as soon as possible to prevent “baked on” food soil.
- Do not allow grease to accumulate under the griddle as it can be a fire hazard. Clean under the griddle with hot, soapy water as soon as it is cool.
- Do not clean your griddle in the dishwasher.
- Do not clean the griddle in the self-cleaning oven. Doing so will damage the nonstick coating. For instructions on how to clean the griddle, see the Cleaning the Cooktop section of this manual.

#### Nonstick Aluminum Griddle

Type of Food	Cook Setting
Bacon	Med
Breakfast Sausage Links	Med
Fried Eggs	Lo
Hamburgers	Med-Hi
Hot Sandwiches (such as Grilled Cheese)	Med
Pancakes	Med-Lo
Warming Tortillas	Med-Lo

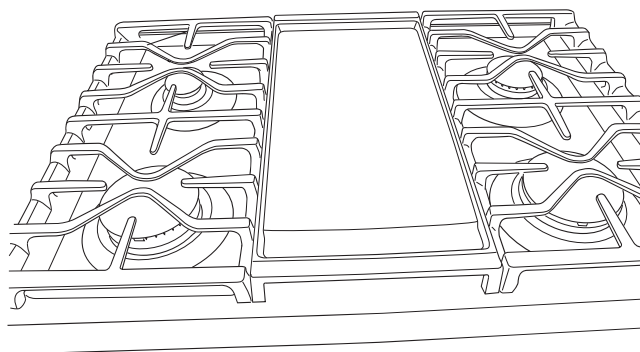

Replace the center grate (if present) with the Nonstick Aluminum Griddle

# Notes

---

# Oven Controls

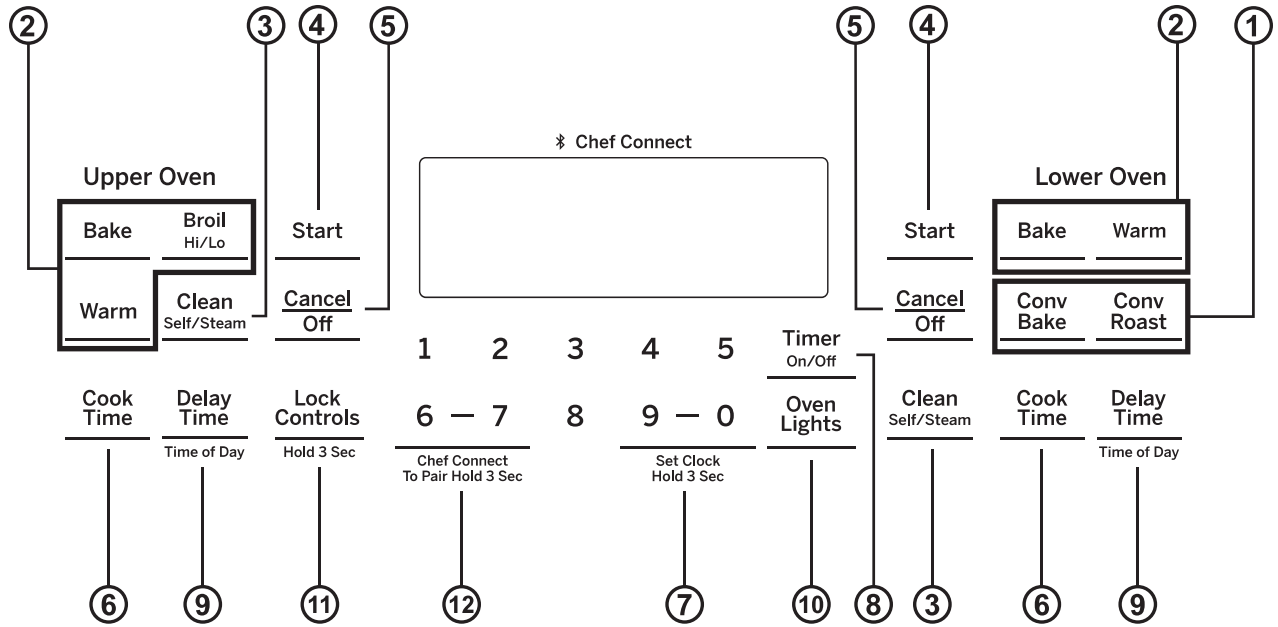



## Oven Controls (Cont.)

- 1. Convection Cooking Modes:** Convection cooking modes use increased air circulation to improve performance. The type of benefit depends on the mode. Your lower oven has the following convection cooking modes: Bake and Roast. See the Cooking Modes section for more information.
- 2. Traditional Cooking Modes:** Your lower oven has the following traditional cooking modes: Bake and Warm. Your upper oven has the following traditional cooking modes: Bake, Broil Hi/Lo and Warm. See the Cooking Modes section for more information.
- 3. Clean:** Your oven may have two cleaning modes: Self Clean and Steam Clean (convection models). See the Cleaning the Oven section for important information about using these modes.
- 4. Start:** Must be pressed to start any cooking, cleaning, or timed function.
- 5. Cancel/Off:** Cancels ALL oven operations except the clock and timer.
- 6. Cook Time:** Counts down cooking time and turns off the oven when the cooking time is complete. Program the desired cooking mode and cooking temperature, then press the **Cook Time** pad. Use the number pads to program a cooking time in hours and minutes, then press **Start**. This can only be used with Traditional Bake, Convection Bake, and Convection Roast.
- 7. Clock:** Sets the oven clock time. Press the **9** and **0** pads and hold for 3 seconds. Use the number pads to program the clock. Press **Start** to save the time.
- 8. Timer On/Off:** Works as a countdown timer. Press the **Timer On/Off** pad and the number pads to program the time in hours and minutes. Press the **Start** pad. The oven will continue to operate when the timer countdown is complete. To turn the timer off press the **Timer On/Off** pad.
- 9. Delay Time:** Delays when the oven will turn on. Use this to set a time when you want the oven to start. Program the desired cooking mode and cooking temperature, then press the **Delay Time** pad. Use the number pads to program the time of day for the oven to turn on, then press **Start**. A cook time may also be programmed if desired. This can only be used with Traditional Bake, Convection Bake, Convection Roast, and Self Clean.  
**NOTE:** Foods that spoil easily—such as milk, eggs, fish, stuffings, poultry, and pork—should not be allowed to sit for more than 1 hour before or after cooking. Room temperature promotes the growth of harmful bacteria. Be sure that the oven light is off, because heat from the bulb will speed harmful bacteria growth.
- 10. Oven Light:** Turns the oven light on or off.
- 11. Lock Controls:** Locks out the control so that pressing any pad does not activate the controls. Press and hold the **Lock Controls** pad for three seconds to lock or unlock the control. **Cancel/Off** is always active, even when the control is locked.
- 12. Chef Connect:** This is a Bluetooth® pairing feature for use with other compatible Chef Connect enabled products like an over-the-range microwave oven or range hood. To pair those products to the range, press and hold the **6** and **7** pads for 3 seconds and follow the corresponding instructions included with the mating Chef Connect enabled product if needed. The range will cancel pairing mode after two minutes if no mating device is detected.

## Special Features

There are several different special features on your range. To change the settings of these special features:

- Press the Upper Oven **Bake** and **Broil** pads at the same time and hold until the special features menu is displayed.
- Use the **3** or **8** number pads to scroll through the special features until the desired feature is displayed.
- Press the **0** number pad to enter into the feature's menu and scroll through the options.
- Once the desired option is displayed, press the **0** pad to save the setting and the **6** pad to exit the menu.

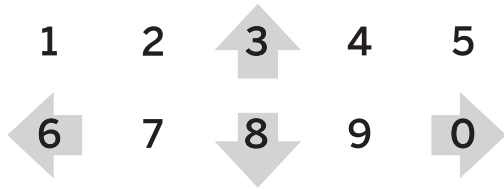

6 = Cancel/Back, 3 = Up, 8 = Down, 0 = Save/Forward

### Adjust the Oven Temperature

This feature allows the oven baking temperature to be adjusted up to 35°F hotter or down to 35°F cooler. Use this feature if you believe your oven temperature is too hot or too cold and wish to change it. This adjustment affects every cooking mode except broil.

Enter into the special features menu as outlined above. Scroll through the features until “Lo offset” is displayed to adjust the lower oven temperature or “Up offset” is displayed to adjust the upper oven temperature then press **0**. Use the **3** pad to increase the adjusted temperature or use the **8** pad to decrease the adjusted temperature. Save and exit the special features menu.

### End of Timer Signals

This is the tone that signals the end of a timer. The tone can be either continuous (Cont) or single (bEEp). The continuous setting (Cont) will repeatedly sound a tone every few seconds until a button on the control is pressed. A single setting (bEEp) will sound just a single tone at the end of the timer. Enter into the special features menu as outlined above. Scroll through the options until “End tonE” is displayed and press **0**. Scroll through the options until the desired setting is displayed. Press **0** to save the setting and then **6** to exit the menu.

### Fahrenheit or Celsius Temperature Display

The oven control is set to use Fahrenheit temperatures (F), but you can change it to use Celsius temperatures (C). Enter into the special features menu as outlined above. Scroll through the options until “deg Unit” is displayed and press **0**. Scroll through the options until the desired setting is displayed. Press **0** to save the setting and then **6** to exit the menu.

### Clock Display

This feature (On/Off) specifies if the time of day is displayed. Enter into the special features menu as outlined above. Scroll through the options until “Cloc diSP” is displayed and press **0**. Scroll through the options until the desired setting is displayed. Press **0** to save the setting and then **6** to exit the menu.

### Clock Configuration

This feature specifies how the time of day will be displayed. You can select a standard 12-hour clock (12) or 24-hour military time display. Enter into the special features menu as outlined above. Scroll through the options until “Cloc cFg” is displayed and press **0**. Scroll through the options until the desired setting is displayed. Press **0** to save the setting and then **6** to exit the menu.

### Sound Volume

This feature allows the oven tone volume to be adjusted between high (Hi), medium (reg), low (Lo) and off (oFF). Enter into the special features menu as outlined above. Scroll through the options until “sound” is displayed and press **0**. Scroll through the options until the desired setting is displayed. Press **0** to save the setting and then **6** to exit the menu. The selected sound option will play once **0** is pressed.

### Auto Recipe Conversion

This feature (On/Off), automatically adjusts the programmed recipe temperature in Convection Multi-Bake mode. Enter into the special features menu as outlined above. Scroll through the options until “Auto rEciPE” is displayed. Scroll through the options until the desired setting is displayed. Press **0** to save the setting and then **6** to exit the menu.

**NOTE:** This option does not convert baking time, only temperatures. This option does not adjust temperatures for Convection Roast mode.

# Sabbath Mode

The Sabbath mode feature complies with standards set forth by Star K. Some of these standards that will be noticed by the consumer include the disabling of tones, disabling of oven lights, and delays of about 30 seconds to one minute on display changes. Only continuous baking or timed baking is allowed in the Sabbath mode. Cooking in the Sabbath mode is a two-step process, first the Sabbath mode must be set and then the bake mode must be set. For double ovens, each oven can be set independently by using the corresponding upper or lower bake pad.

## Setting the Sabbath Mode

1. Press the Upper Oven **Bake** and **Broil** pads at the same time and hold until the special features menu is displayed.
2. Use the **3** or **8** number pads to scroll through the special features until "SAbbAth" is displayed and then press **0**. Refer to the graphic in the Special Features section to see how the number keys are mapped.
3. Use the **3** or **8** number pads to scroll through the options until "On" is shown in the display, then press the **0** number pad to save the setting. Press **6** to exit the Special Features menu. A single bracket "]" will appear in the display indicating that the Sabbath mode is set. The clock will not be displayed. Continuous bake or timed bake can now be programmed.

## Starting a Continuous Bake

1. Press the **Bake** pad.
2. If the desired temperature is 350F, press **Start**. If a different cooking temperature is desired, use the **1** through **5** number pads or **Timer** pad to select a preset cooking temperature, then press **Start**. Refer to the graphic below to determine which pad sets the desired cooking temperature.

After a delay, a second bracket "]" will appear in the display indicating that the oven is baking.

Temperature (°F)					400
<b>1</b>	<b>2</b>	<b>3</b>	<b>4</b>	<b>5</b>	<b>Timer</b> On/Off
170	200	250	300	325	
<b>6</b>	<b>7</b>	<b>8</b>	<b>9</b>	<b>0</b>	<b>Lock</b> <b>Controls</b>
2h	2.5h	3h	3.5h	4h	Hold 3 Sec
Time (hours)					6h

1 = 170° F, 2 = 200° F, 3 = 250° F, 4 = 300° F, 5 = 325° F, Timer = 400° F

6 = 2 hours, 7 = 2.5 hours, 8 = 3 hours, 9 = 3.5 hours,  
0 = 4 hours, Lock Controls = 6 hours

## Adjusting the Temperature

1. Press **Bake**, use the **1** through **5** number pads and the **Timer** pad to select a different preset cooking temperature, and press **Start**.
2. Since no feedback is given during temperature change, an oven thermometer can be used to confirm temperature changes.

## Starting a Timed Bake

1. Press the **Bake** pad.
2. If the desired temperature is 350F, use the **6** through **0** number pads or the **Lock Control** pad to select a cooking time. If a cooking temperature other than 350F is desired, use the **1** through **5** number pads or the **Timer** pad to select a preset cooking temperature, then select the cooking time. Refer to the graphic on this page to determine which pad sets the desired cooking temperature and cooking time.
3. Press **Start**.

After a delay, a second bracket "]" will appear in the display indicating that the oven is baking. When the cook time expires, the display will change back to a single bracket "]" indicating that the oven is no longer baking. No tone will sound when the cook time is complete.

## Exit the Sabbath Mode

Exiting the Sabbath mode should be done after the Sabbath is over.

1. Press **Cancel/Off** to end any timer bake mode that may be running.
2. Press **Bake** and **Broil** pads at the same time and hold until the Special Features menu is displayed.
3. Use the **3** or **8** number pads to scroll through the special features until "SAbbAth" is displayed, then press **0**.
4. Use the **3** or **8** number pads to scroll through the options until "OFF" is displayed and press **0** to save the setting. Press the **6** number pad to exit the Special Features menu.

## Sabbath Mode Power Outage Note

If a power outage occurs while the oven is in Sabbath Mode, the unit will return to Sabbath Mode when power is restored, however the oven will return to the off state even if it was in the middle of a bake cycle when the power outage occurred.

## Cookware Guidelines

The material, finish, and size of cookware affect baking performance.

Dark, coated and dull pans absorb heat more readily than light, shiny pans. Pans that absorb heat more readily can result in a browner, crisper and thicker crust. If using dark and coated cookware check food earlier than the minimum cook time. If undesirable results are obtained with this type of cookware consider reducing oven temperature by 25° F next time.

- Shiny pans can produce more evenly cooked baked goods such as cakes and cookies.
- Glass and ceramic pans heat slowly but retain heat well. These types of pans work well for dishes such as pies and custards.
- Air insulated pans heat slowly and can reduce bottom browning.
- Keep cookware clean to promote even heating.

## Cooking Modes

Your new oven has a variety of cooking modes to help you get the best results. These modes are described below. Refer to the Cooking Guide section for recommendations for specific foods. Remember, your new oven may perform differently than the oven it is replacing.

### Bake

The bake mode is for baking and roasting. This mode uses heat primarily from the lower burner but also from the upper burner to cook food. When preparing baked goods such as cakes, cookies and pastries, always preheat the oven first. Follow recipe recommendations for food placement. If no guidelines are provided, center food in the oven. To use this mode press the **Bake** pad, enter a temperature with the number pads, and then press **Start**.

### Warm

Warm mode is designed to keep hot foods hot. Cover foods that need to remain moist and do not cover foods that should be crisp. Preheating is not required. Do not use warm to heat cold food other than crisping crackers, chips or dry cereal. It is also recommended that food not be kept warm for more than 2 hours. See the Oven Controls section for more information.

### Broiling Modes

Broil is only available in the upper oven. Always broil with the oven door closed. Monitor food closely while broiling. Use caution when broiling on the upper rack positions as placing food closer to the broil burner increases smoking, spattering and the possibility of fats igniting.

Try broiling foods that you would normally grill. Adjust rack positions to adjust the intensity of the heat to the food. Place foods closer to the broil burner when a seared surface and rare interior is desired. Thicker foods and foods that need to be cooked through should be broiled on a lower rack position or by using the Broil Lo mode.

### Broil Hi

The Broil Hi mode uses intense heat from the upper burner to sear foods. Use Broil Hi for thinner cuts of meat and/or foods you prefer less done on the interior. To use this mode press the **Broil** pad once and then press **Start**. It is not necessary to preheat when using this mode.

### Broil Lo

The Broil Lo mode uses less intense heat from the upper burner to cook food thoroughly while also browning the surface. Use Broil Lo for thicker cuts of meat and/or foods that you would like cooked all the way through. To use this mode press the **Broil** pad twice and then press **Start**. It is not necessary to preheat when using this mode.

### Convection Bake

Convection Bake is only available in the lower oven. The Convection Bake mode is intended for baking on multiple racks at the same time. This mode uses air movement from the convection fan to enhance cooking evenness. Your oven is equipped with Auto Recipe Conversion, so it is not necessary to adjust the temperature when using this mode. To use this mode press the **Conv Bake** pad, enter a temperature with number pads, and then press **Start**. Always preheat when using this mode.

### Convection Roast

Convection Roast is only available in the lower oven. The Convection Roast mode is intended for roasting whole cuts of meat on a single rack. This mode uses heat from the lower bake burner along with air movement to improve browning and reduce cooking time. It is not necessary to convert temperature. Check food earlier than the recipe suggested time when using this mode, or use the probe (on some models). To use this mode press the **Conv Roast** pad, enter a temperature with the number pads, and then press **Start**. It is not necessary to preheat when using this mode.



# Oven Racks

## Rack Positions

Your oven has two rack positions in the upper oven (A, B) and four rack positions in the lower oven (R, 1, 2, 3). Recommended rack positions for various types of foods are provided in the Cooking Guide. Adjusting rack position is one way to impact cooking results. For example, if you would prefer darker tops on cakes, muffins, or cookies, try moving food one rack position higher. If you find foods are too brown on top try moving them down next time.

When baking with multiple pans and on multiple racks, ensure there is sufficient space between pans to allow air to flow. This may improve cooking evenness.

## Removing and Replacing Flat Racks

When placing and removing cookware, pull the rack out to the bump (stop position) on the rack support.

To remove a rack, pull it toward you until it reaches the stop position, tilt up the front of the rack and pull it out.

To replace a rack, place the curved end of the rack onto the rack supports. Tilt up the front of the rack and push the rack in until it stops. Then lay the rack flat and push it in until it is all the way into the oven.

Racks may become difficult to slide, especially after a self-clean cycle. To improve sliding conditions, use a soft cloth or paper towel to rub vegetable oil on the left and right edges of the racks and/or rack supports.

**NOTE:** Remove unused racks when using the oven for faster preheat, improved efficiency, and optimal cooking performance.

## Extension Racks (on some models)

Extension racks have a frame that locks into the rack supports on both sides. Once the frame is locked into place, always use the upper front rail to pull the rack out to its full extension position when placing or removing cookware.

If extension racks are difficult to extend, lubricate the racks with the graphite lubricant provided with your oven. Remove the rack from the oven (see Extension Rack Removal), remove debris in the slide tracks with a paper towel, shake the graphite lubricant, and place 4 small drops on the two bottom tracks of the left and right sides. Open and close the rack several times to distribute the lubricant. See the Assistance/Accessories section for instructions on ordering additional racks and graphite lubricant.

# Oven Air Vents

Never block the vents (air openings) of the range. They provide the air inlet and outlet that are necessary for the range to keep cool and operate properly with correct combustion.

Air openings are located at the rear of the cooktop, at the top and bottom of the oven door, and at the bottom of the range.

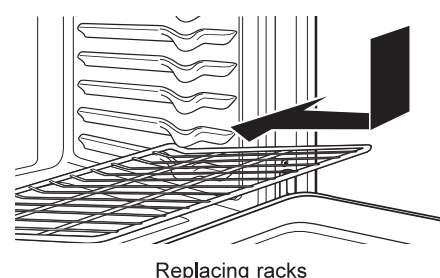
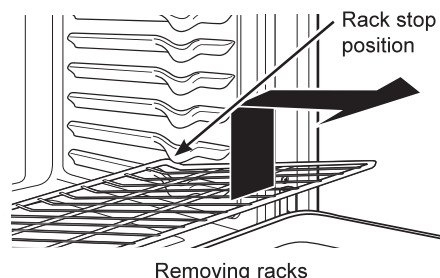
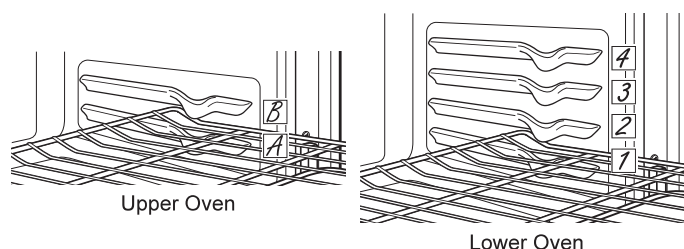

## Extension Rack Removal

1. Make sure the rack is pushed all the way into the oven.
2. Firmly holding onto both the upper and lower front rails, pull the rack toward you, tilt the front end up and pull the rack out.

## Extension Rack Replacement

1. Place the curved end of the rack onto the rack supports.
2. Tilt up the front of the rack and push the rack in until it stops.
3. Lay the rack flat and push it in until it is all the way into the oven.

If extension racks are difficult to replace or remove, wipe the oven rack supports with cooking oil. Do not wipe oil on the rack slides.

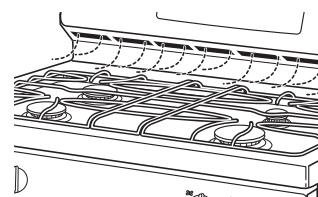

Vent appearance and location vary.

# Cooking Guide

FOOD TYPE	RECOMMENDED MODE(S)	OVEN (Upper/Lower)	RECOMMENDED RACK POSITION(S)	ADDITIONAL SUGGESTIONS
<b>Baked Goods</b>				
Layer cakes, sheet cakes, bundt cakes, muffins, quick breads, biscuits, scones on a Single Rack	Bake	Lower Upper	3 B	Use shiny cookware.
Layer cakes* on Multiple Racks	Convection Bake Bake	Lower	2 and 4	Ensure adequate airflow (see illustration below).
Chiffon cakes (angel food)	Bake	Lower	2	Use shiny cookware.
Cookies, biscuits, scones on a Single Rack	Bake	Lower Upper	3 B	Use shiny cookware.
Cookies, biscuits, scones on Multiple Racks	Convection Bake Bake	Lower	2 and 4	Ensure adequate airflow.
<b>Beef &amp; Pork</b>				
Hamburgers	Broil Hi	Upper	B	Use a broil pan; move food down for more doneness/less searing. Watch food closely when broiling.
Steaks & Chops	Broil Hi	Upper	B	Use a broil pan; move food down for more doneness/less searing. Watch food closely when broiling.
Roasts	Convection Roast Bake	Lower	1 or 2	Leave uncovered, use a low sided pan such as a broil pan.
<b>Poultry</b>				
Whole chicken	Convection Roast Bake	Lower	1 or 2	Leave uncovered, use a low sided pan such as a broil pan.
Bone-in chicken breasts, legs, thighs	Broil Lo Bake	Upper Lower	A 3	If breaded or coated in sauce avoid Broil Hi modes. Broil skin side down first. Watch food closely when broiling.
Boneless chicken breasts	Broil Lo Bake	Upper Lower	A 3	Watch food closely when broiling.
Whole turkey	Convection Roast Bake	Lower	1 or 2	Leave uncovered, use a low sided pan such as a broil pan. Watch food closely when broiling.
Turkey Breast	Bake	Lower	3	Leave uncovered, use a low sided pan such as a broil pan.
<b>Fish</b>	Broil Lo Bake	Upper Lower	A 3	Watch food closely when broiling.
<b>Casseroles</b>	Bake	Lower Upper	3 B	
<b>Frozen Convenience Foods</b>				
Pizza, potato products, chicken nuggets, appetizers on a Single Rack	Bake	Lower Upper	3 B	Use shiny cookware.
Pizza, potato products, chicken nuggets, appetizers on Multiple Racks	Convection Bake Bake	Lower	2 and 4	Use shiny cookware.

\*When baking four cake layers at a time, stagger the pans as shown so that one pan is not directly above another.

Cook food thoroughly to help protect against food borne illness. Minimum safe food temperature recommendations for food safety can be found at [www.IsItDoneYet.gov](http://www.IsItDoneYet.gov). Make sure to use a food thermometer to take food temperatures.

**NOTE:** Remove unused racks when using the oven for faster preheat, improved efficiency and optimal cooking performance.

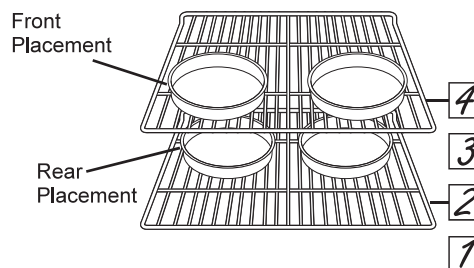



# Aluminum Foil and Oven Liners

---

**⚠ CAUTION** Do not use any type of foil or oven liner to cover the oven bottom. These items can block airflow or melt, resulting in damage to the product and risk of carbon monoxide poisoning, smoke or fire. Damage from improper use of these items is not covered by the product warranty.

Foil may be used to catch spills by placing a sheet on a lower rack, several inches below the food. Do not use more foil than necessary and never entirely cover an oven rack with aluminum foil. Keep foil at least 1-1/2" from oven walls to prevent poor heat circulation.

# Cleaning the Oven

---

Be sure all controls are off and all surfaces are cool before cleaning any part of the oven.

## Oven Interior

The interior of your new oven can be cleaned manually or by using the Steam Clean or Self Clean modes.

Spillage of marinades, fruit juices, tomato sauces and basting liquids containing acids may cause discoloration and should be wiped up as soon as hot surfaces cool, then clean and rinse.

### Manual Cleaning

Do not use oven cleaners, abrasive cleaners, strong liquid cleansers, steel wool, scouring pads or cleaning powders on the interior of the oven. Clean with mild soap and water or 50/50 solution of vinegar and water. Rinse with clean water and dry with a soft cloth. When cleaning surfaces, make sure that they are at room temperature and not in direct sunlight.

### Steam Clean Mode

The Steam Clean feature is for cleaning light soil from your oven at a lower temperature than Self Clean.

To use the Steam Clean feature:

1. Start with the oven at room temperature.
2. Wipe excess grease and soils from the oven.
3. Pour one cup of water onto the bottom of the oven.
4. Close the door.
5. Press the **Clean** pad twice, then press **Start**.

You cannot open the door during the 30 minute Steam Clean cycle. At the end of the Steam Clean cycle, soak up the remaining water, and wipe the moisture-softened soil from the oven walls and door.

### Self Clean Mode

Read Self-Cleaning Oven Safety Instructions at the beginning of this manual before using the Self Clean Mode. Self Clean uses very high temperatures to clean the oven interior. For a moderately soiled oven, run a 3 hour self-clean cycle. For a heavily soiled oven, run a 5 hour self-clean cycle. Only self-clean (black) racks and grates may remain in the oven during the self-clean cycle. All other items, including nickel plated (silver) racks, should be removed. If nickel plated (silver) racks are left in the oven during a self-clean cycle, the racks will tarnish. If either type of rack is left in the oven during a self-clean cycle, the rack may become difficult to slide. See the Oven Racks section for instructions on how to improve.

**IMPORTANT:** The health of some birds is extremely sensitive to the fumes given off during the self-cleaning cycle of any range. Move birds to another well-ventilated room.

To use the Self Clean feature:

1. Start with the oven at room temperature.
2. Wipe excess grease and soils from the oven and interior door.
3. Remove all items other than self-clean (black) racks and grates, if desired. See Cleaning the Cooktop to determine if your grates may be self-cleaned and for important details regarding grate placement.
4. Close the door.
5. Press the **Self Clean** pad, set a time between 3 and 5 hours, and then press **Start**.

You cannot open the door during the self-clean cycle. The door will remain locked after the self-clean cycle until the oven cools below the unlocking temperature. At the end of the self-clean cycle, allow the oven to cool and wipe any ash out of the oven.

---

## Oven Exterior

Do not use oven cleaners, abrasive cleansers, strong liquid cleansers, steel wool, plastic scouring pads or cleaning powders on the interior or exterior of the oven. Clean with a mild soap and water or a 50/50 solution of vinegar and water. Rinse with clean water and dry with a soft cloth. When cleaning surfaces, make sure that they

are at room temperature and not in direct sunlight.

Spillage of marinades, fruit juices, tomato sauces and basting liquids containing acids may cause discoloration and should be wiped up as soon as hot surfaces cool, then clean and rinse.

---

## Oven Racks

All oven racks may be cleaned by hand with an abrasive cleaner or steel wool. Self-clean (black) oven racks may remain in the oven during the self-clean cycle. Nickel-plated (silver) racks should not remain in the oven during the self clean cycle. Doing so will tarnish the racks. If either type of rack is left in the oven during a self-clean cycle, the rack may become difficult to slide.

After cleaning the racks, use a soft cloth or paper towel to rub a small amount of vegetable oil on the left and right edges of the rack. This will ensure the racks are easy to slide in and out of the oven

# Cleaning the Cooktop

## Control Panel and Knobs

Wipe the control panel after each use of the oven with a damp cloth. For cleaning, use mild soap and water or a 50/50 solution of vinegar and water. Rinse with clean water. Polish dry with a soft cloth.

Do not use abrasive cleansers, strong liquid cleansers, plastic scouring pads or oven cleaners on the control panel—they will damage the finish.

### Stainless Steel Surfaces (on some models)

Do not use a steel wool pad; it will scratch the surface.

To clean the stainless steel surface, use warm sudsy water or a stainless steel cleaner or polish. Always wipe the surface in the direction of the grain. Follow the cleaner instructions for cleaning the stainless steel surface.

Cleaners with oxalic acid such as Bar Keepers Friend Soft Cleanser™ will remove surface rust, tarnish and small blemishes. Use only a liquid cleanser free of grit and rub in the direction of the brush lines with a damp, soft sponge.

To inquire about purchasing cleaning products including stainless steel appliance cleaner or polish, read the Assistance/Accessories sections at the beginning of this manual.

For easier cleaning, the control knobs may be removed by pulling them directly outwards once the knobs are in the OFF position. Do not pull knobs up or down or hang objects on them. This can damage the gas valve shaft. When removing the tri-ring (on some models) and the dual-oval (on some models) burner knobs, remember their location. While all other knobs are interchangeable, these knobs must be placed in the same location after cleaning. See the Surface Burner section for a detailed view of these knobs. The knobs can be washed by hand with soap and water or in a dishwasher.

To replace knobs after cleaning, align the hole on the knob backside with the gas valve shaft and push inward until the knob is securely fastened. All knobs are interchangeable

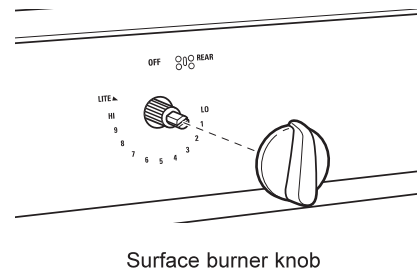

Surface burner knob

## Cooktop Surface

Do not use oven cleaners, abrasive cleansers, strong liquid cleansers, steel wool, plastic scouring pads, or cleaning powders on the cooktop surface. Clean with a mild soap and water or a 50/50 solution of vinegar and water. Rinse with clean water and dry with a soft cloth. When cleaning surfaces, make sure that they are at room temperature and not in direct sunlight.

Spillage of marinades, fruit juices, tomato sauces and basting liquids containing acids may cause discoloration and should be wiped up as soon as hot surfaces cool, then clean and rinse.

If your model has a stainless steel cooktop surface, refer to the Stainless Steel Surface cleaning instructions featured in the Control Panel and Knobs section.

# Cleaning The Cooktop (Cont.)

## Removal of Surface Burners for Cleaning

Turn all controls OFF. Allow cooktop to cool before removing grates and burner parts. When removing the burner caps and heads, remember their size and location. Replace them in the same location after cleaning.

**CAUTION** Do not attempt to remove oval, dual oval or tri-ring burner caps from the burner heads.

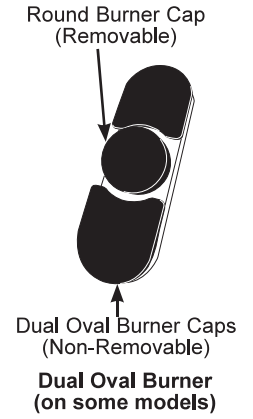
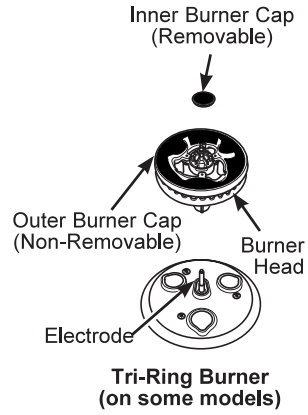
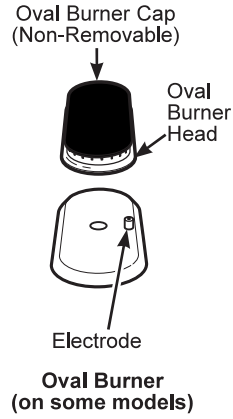
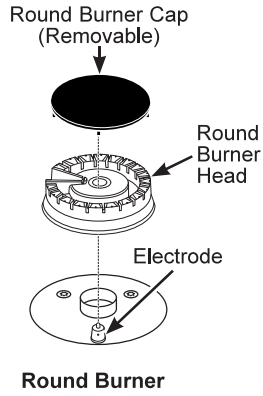

# Cleaning the Cooktop (Cont.)

## Cleaning the Surface Burners (Cont.)

### Cleaning the Burner Caps

Wash burner caps in hot, soapy water and rinse with clean water. You may scour with a plastic scouring pad to remove burned-on food particles. The round burner caps may also be cleaned in your dishwasher.

### Cleaning the Burner Heads

Wash the burner heads routinely, especially after bad spillovers which could clog the burner openings. Lift burners off when cool. Wash with hot, soapy water. Rinse with clean water. For more stubborn stains, use a brush with plastic bristles.

**NOTE:** Do not use steel wool or scouring pads to clean the burner parts as these may clog the openings. Never wash burner heads in your dishwasher as dishwasher. Doing so may cause them to discolor.

The ports in the burner heads must be kept clean at all times for an even, unhampered flame.

Clogged or dirty burner ports or electrodes will not allow the burner to operate properly.

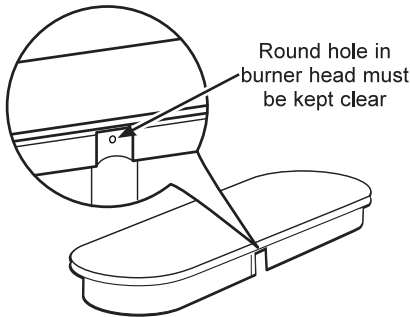

For proper ignition, make sure the small hole in the notch that fits over the electrode is kept open. A sewing needle or wire twist-tie works well to unclog it.

### Replacing Surface Burners

Before replacing the burner caps, heads and oval head/cap assembly, shake out excess water and allow them to dry thoroughly.

Replace burner heads in the correct locations according to size. Ensure each cap is properly seated on the burner head, as pictured below.



Burner cap is NOT properly seated.



Burner cap is NOT properly seated.

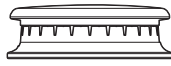

Burner cap is properly seated.

### ⚠ CAUTION

**Do not operate the cooktop without all burner parts and grates in place.**

Any spill on or around an electrode must be carefully cleaned. Avoid hitting the electrode with anything hard or it could be damaged.

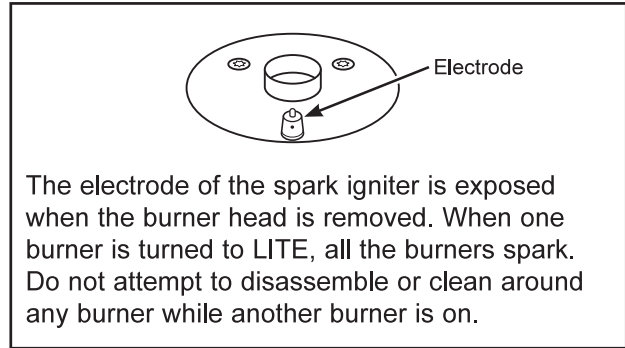

The electrode of the spark igniter is exposed when the burner head is removed. When one burner is turned to LITE, all the burners spark. Do not attempt to disassemble or clean around any burner while another burner is on.

## Cleaning the Cooktop (Cont.)

### Burner Grates

#### Manual Cleaning

Grates should be washed in hot, soapy water and rinsed with clean water. To soften burned-on food, place grates in a solution containing ¼-cup of household ammonia for several hours. Afterward, scrub grates with a plastic scouring pad soaked in hot, soapy water. Rinse well and dry.

#### Self Clean Mode (on some models)

If your grates do not have rubber bumpers on their bottom surface, they may be cleaned in the lower oven using the self-clean cycle. Do not attempt to clean your grates in the oven if your grates have rubber bumpers. Doing so will destroy the rubber bumpers and may affect the function of your surface burners.

Porcelain-coated grates may gradually dull if continually exposed to self-clean temperatures.

If your oven is equipped with self-clean (black) racks, it is recommended to follow the instructions for placing grates on racks. If your oven is equipped with nickel-plated (silver) racks, it is recommended to follow the instructions for placing grates on the oven bottom. Nickel-plated racks should not remain in the oven during the self clean cycle. Doing so will tarnish the racks. If either type of rack is left in the oven during a self-clean cycle, the rack may become difficult to slide.

**NOTE:** When placing or removing grates from the oven, do not slide the grates on the racks or oven bottom. Doing so could damage the enamel on the racks or oven bottom.

#### To self-clean your grates on self-clean racks (Lower Oven Only):

1. Insert racks in positions 1, 3, and 4.
2. Gently place one grate on each rack.

#### To self clean your grates on the oven bottom (Lower Oven Only):

1. Remove all oven racks.
2. Gently place one grate on the center of the oven bottom with the grate oriented in the upright position. Stack remaining grate(s) as shown below. Do not place or stack grates in any other configuration or in the upper oven.

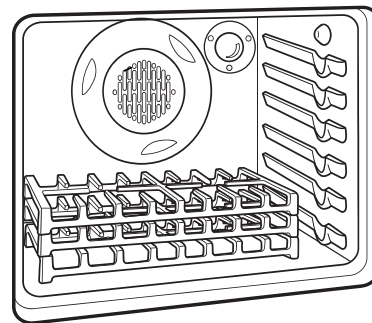

Once the grates are placed in the oven, operate the self-clean cycle per the instruction in the Cleaning the Oven section.

**NOTE:** Use caution when removing the grates from the oven after the self-clean cycle has ended. The grates may still be hot.

Once the self-clean cycle is complete, the grates may carefully be removed. You may notice a white residue on the grates. Wipe it off with a damp sponge. If white spots persist, wet the sponge with a 50/50 solution of vinegar and water and wipe the grates again.

When replacing the grates on the cooktop, be sure to locate them correctly. Grates should fit securely into the cooktop.

### Grate Support Bumpers (on some models)

If any of the rubber grate support bumpers in the cooktop are missing or damaged, replacement parts can be obtained by calling 1.800.GE.CARES.

To insert the new bumpers, simply place the cone-shaped end of the bumper into the hole in the cooktop and push down while gently twisting the bumper.

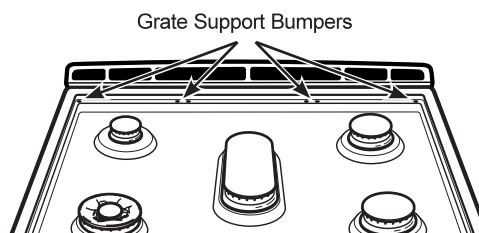

### Griddles (on some models)

**Nonstick Aluminum Griddle:** Avoid scraping the griddle surface with metal utensils. Wash your griddle with dish soap and hot water. If necessary, scrub with a non-abrasive plastic pad.

**Reversible Cast-Iron:** Clean your reversible cast-iron griddle with a stiff brush and hot water. Using soap is not recommended, and harsh detergents should never be used as they will remove the seasoning. Rinse with hot water and dry thoroughly. After rinsing, pre-season the griddle by applying a light coat of cooking oil to the griddle surface. Wipe off excess oil with a paper towel. Store in a cool, dry place.

#### Griddle Precautions:

- If something has spilled under the griddle, it should be cleaned up as soon as possible to prevent the spill from getting baked onto the cooktop.
- Do not allow grease to accumulate under the griddle as it can be a fire hazard. Clean under the griddle with hot, soapy water as soon as it is cool.
- Do not wash your griddle in the dishwasher.
- Do not clean the griddle in the self-cleaning oven.



# Cleaning the Door

---

## Cleaning the Oven Door

### Cleaning the Door Interior

Do not allow excess water to run into any holes or slots in the door.

Wipe dish soap over any baked-on spatters on the glass. Use a single sided safety razor blade to clean it off. Then wipe over the glass with a soapy cloth to remove any residue and dry off.

The area outside the gasket can be cleaned with a soap-filled plastic scouring pad. Do not rub or clean the door gasket - it has an extremely low resistance to abrasion.

If you notice the gasket becoming worn, frayed or damaged in any way or if it has become displaced on the door, you should have it replaced.

### Cleaning the Door Exterior

If a stain on the door vent trim is persistent, use a mild abrasive cleaner and a sponge-scrubber for best results. Do not use this method on any other surface.

### Stainless Steel Surfaces (on some models)

Do not use a steel wool pad; it will scratch the surface.

To clean the stainless steel surface, use warm sudsy water or a stainless steel cleaner or polish. Always wipe the surface in the direction of the grain. Follow the cleaner instructions for cleaning the stainless steel surface.

To inquire about purchasing cleaning products including stainless steel appliance cleaner or polish, read the Assistance/Accessories sections at the beginning of this manual.

# Maintenance

## Oven Light Replacement

**⚠ WARNING SHOCK OR BURN HAZARD:** Before replacing oven light bulb, disconnect the electrical power to the oven at the main fuse or circuit breaker panel. Failure to do so may result in electric shock or burn.

**⚠ CAUTION BURN HAZARD:** The glass cover and bulb should be removed when cool. Touching hot glass with bare hands or a damp cloth can cause burns.

**NOTE:** The glass cover should be removed only when cold. Wearing latex gloves may offer a better grip. Before replacing the bulb, disconnect electrical power to the oven at the main fuse or circuit breaker panel. Let the bulb cool completely before removing it. For your safety do not touch a hot bulb with a damp cloth. If you do the bulb may break.

**To remove:**

Turn the glass cover counterclockwise 1/4 turn until the tabs of the glass cover clear the grooves of the socket and pull the cover off. Remove the bulb.

**To replace:**

Put in a new 40-watt appliance bulb. Place the tabs of the glass cover into the grooves of the socket. Turn the glass cover clockwise 1/4 turn.

**NOTE:**

- A 40-watt appliance bulb is smaller than a standard 40-watt household bulb.
- Reconnect electrical power to the oven once the new bulb is installed.
- For improved lighting inside the oven, clean the glass cover frequently using a wet cloth. This should be done when the oven is completely cool.

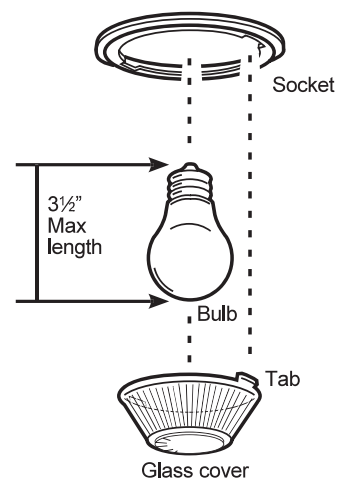

## Lift-Off Oven Door

The door is very heavy. Be careful when removing and lifting the door. Do not lift door by the handle.

**To Remove the Door:**

1. Fully open the door.
2. Pull the hinge locks up and away from the range frame to the unlocked position.
3. Firmly grasp both sides of the door near the top.
4. Close door until the top of the door is approximately 6" from the range frame.
5. Lift door up and away from the range until both hinge arms are clear of the slots in the range frame.

**To Replace the Door:**

1. Firmly grasp both sides of the door near the top.
2. With the door at the same angle as the removal position, rest the notch on the underside of the left hinge arm on the bottom edge of the left hinge slot. The notch in the hinge arm must be fully seated into the bottom of the slot. Repeat for the right side.
3. Fully open the door. If the door will not fully open, the notches in the bottoms of the hinge arms have not seated correctly in the bottom edge of the slot. Lift the door off the range and repeat previous step.
4. Push the hinge locks toward the range cavity and down to the locked position.
5. Close the oven door.

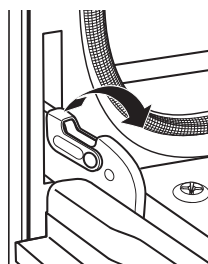

Pull hinge locks up to unlock

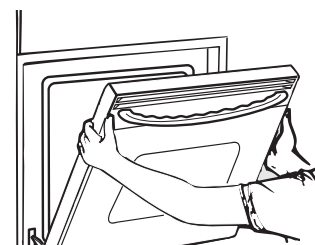

Removal position

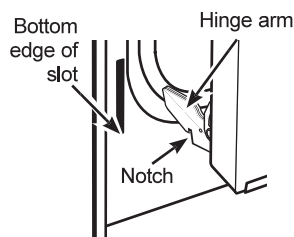

Rest notch on bottom edge of hinge slot

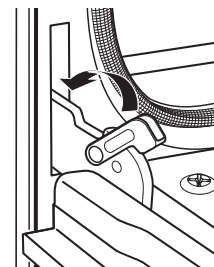

Push hinge locks down to lock

# Maintenance (Cont.)

## Lift-Off Upper Oven Door

The door is very heavy. Be careful when removing and lifting the door. Do not lift door by the handle.

### To Remove the Door:

1. Fully open the door.
2. Lift up on the hinge lock toward the oven frame until they stop.
3. Close the door to 45 degrees (you will feel the door stop). The hinge lock will contact the oven frame.
4. On both sides of the door, press down on the release buttons on each hinge.
5. Lift door up until it is clear of the hinge.
6. Pull on hinge arms slightly to relieve pressure on the locking tabs.
7. Push the hinge locks down onto the hinge.
8. Push the hinges in toward the unit so they are closed.

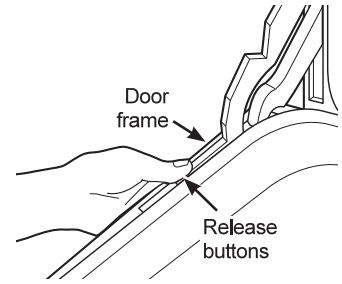
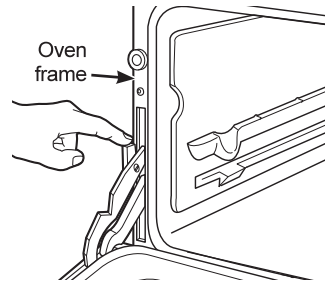

### To Replace the Door:

1. Pull the hinges down away from the oven frame to the fully open position.
2. Lift up on the hinge locks toward the oven frame until they stop.
3. The hinges will release to the 45-degree position. The hinge locks will contact the oven frame.
4. Slide the door back onto the hinges. Make sure the buttons pop back out.
5. Fully open the door.
6. Push the hinge locks down onto the hinge.
7. Close the oven door.

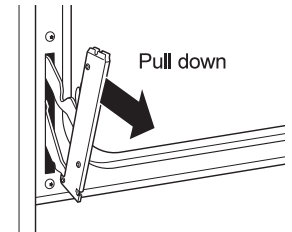
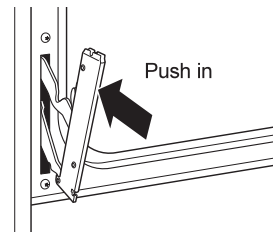

## Troubleshooting tips ... Before you call for service

Save time and money! Review the charts on the following pages first and you may not need to call for service.

Problem	Possible Cause	What To Do
My new oven doesn't cook like my old one. Is something wrong with the temperature settings?	Your new oven has a different cooking system from your old oven and therefore may cook differently than your old oven.	For the first few uses, follow your recipe times and temperatures carefully and use rack positions recommended in the Cooking Guide. If you still think your new oven is too hot or too cold, you can adjust the temperature yourself to meet your specific cooking preference. See the Special Features section.
Food does not bake properly	Oven controls improperly set.	See the Cooking Modes section.
	Rack position is incorrect or rack is not level.	See the Cooking Modes section and Cooking Guide.
	Incorrect cookware or cookware of improper size being used.	See the Cookware section.
	Oven temperature needs adjustment.	See the Special Features section.
Food does not broil properly	Oven controls improperly set.	Make sure you select the appropriate broil mode.
	Improper rack position being used.	See Cooking Guide for rack location suggestions.
	Cookware not suited for broiling.	Use a pan specifically designed for broiling.
	Aluminum foil on the broil pan has not been fitted properly or slit to drain grease.	If using aluminum foil on broil pan, wrap tightly and add slits conforming to those in the pan to allow grease to drain.
Oven temperature too hot or too cold	Oven temperature needs adjustment.	See the Special Features section.
Oven and/or display appears not to work	A fuse in your home may be blown or the circuit breaker tripped.	Replace the fuse or reset the circuit breaker.
	Oven controls improperly set.	See the Using the Oven section.
	Oven is in Sabbath Mode.	Verify, that the oven is not in Sabbath Mode. See the Special Features section.
	The clock is turned off.	See the Special Features section.
"Crackling" or "popping" sound	This is the sound of the metal heating and cooling during both the cooking and cleaning functions.	This is normal.
Why is my range making a "clicking" noise when using my oven?	Your range has been designed to maintain a tighter control over your oven's temperature. You may hear your oven's heating elements "click" on and off more frequently than in older ovens to achieve better results during baking, broiling, and self-clean cycles.	This is normal.
Sometimes the oven takes longer to preheat to the same temperature	Cookware, food, and/or number of racks in oven.	Cookware, food, and racks in the oven will cause differences in preheat times. Remove excess items to reduce preheat time.

# Troubleshooting tips ... Before you call for service

Problem	Possible Cause	What To Do
Oven light does not work	Light bulb is loose or defective.	Tighten or replace bulb. See the Maintenance section for instructions on how to replace the bulb.
Oven will not self-clean	The temperature is too high to set a self-clean operation.	Allow the oven to cool and reset the controls.
	Oven controls improperly set.	See the Cleaning the Oven section.
Excessive smoking during clean cycle	Excessive soil or grease.	Press the <b>Cancel/Off</b> pad. Open the windows to rid the room of smoke. Wait until the <b>LOCKED</b> light goes off. Wipe up the excess soil and reset the clean cycle.
Oven not clean after a clean cycle	Oven controls improperly set.	See the Cleaning the Oven section.
	Oven was heavily soiled.	Clean up heavy spillovers before starting the clean cycle. Heavily soiled ovens may need to self-clean again or for a longer period of time.
Strong “burning” or “oily” odor emitting from the vent	This is normal in a new oven and will disappear in time.	To speed the process, set a self-clean cycle for a minimum of 3 hours. See the Cleaning the Oven section. This is temporary.
Excessive smoking during broiling	Food too close to burner element.	Lower the rack position of the food.
Oven door will not open or <b>LOCKED</b> light is on when you want to cook.	The oven door is locked because the temperature inside the oven has not dropped below the locking temperature.	Press the <b>Cancel/Off</b> pad. Allow the oven to cool below the locking temperature.
" <b>LOCK DOOR</b> " flashes in the display	The self-clean cycle has been selected but the door is not closed.	Close the oven door.
“F— and a number or letter” flash in the display	You have a function error code.	Press the <b>Cancel/Off</b> pad. Allow the oven to cool for one hour. Put the oven back into operation. If the function code repeats, disconnect all power to the oven for at least 30 seconds and then reconnect power. If the function error code repeats again, call for service.
Power outage, clock flashes	Power outage or surge	Reset the clock. If the oven was in use, you must reset it by pressing the <b>Cancel/Off</b> pad, setting the clock and resetting any cooking function.
Lock Controls or Control Lockout feature is activated		If <b>LOC ON</b> appears in the display, the range control is locked. Turn this feature off to use the range. See the Lock Control feature in the Oven Controls section.
Burners do not light	Plug on range is not completely inserted in the electrical outlet.	Make sure electrical plug is plugged into a live, properly grounded outlet.
	Gas supply not connected or turned on.	See the Installation Instructions that came with your range.
	A fuse in your home may be blown or the circuit breaker tripped.	Replace the fuse or reset the circuit breaker.
	Burner parts not replaced correctly.	See the Care and Cleaning of the range section.
	Burner slots near the electrode, or the round lighter port on the oval burner, may be clogged.	Remove the burners and clean them. Check the electrode area for burned-on food or grease. See the Care and Cleaning of the range section.
	Food residue on electrode	Lightly polish flat tip of electrode with nail file or sandpaper until shiny.

## Troubleshooting tips ... Before you call for service

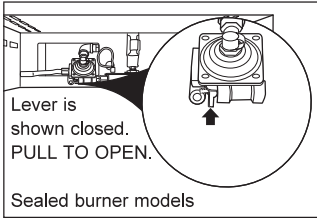
<b>Problem</b>	<b>Possible Cause</b>	<b>What To Do</b>
Top burners do not burn evenly	Improper burner assembly.	Make sure the burner caps are seated correctly. See the Care and Cleaning of the range section.
	Burner slots on the side of the burner may be clogged.	Remove the burners for cleaning. See the Care and Cleaning of the range section.
Burner flames are very large or yellow	Improper air to gas ratio.	If range is connected to Propane gas, contact the technician who installed your range or made the conversion.
Surface burners light but bake and broil burners do not.	Gas to the oven burners may have been shut off.	<p>The oven gas shut-off is located on the gas regulator near the gas line attachment to your range. Locate it and flip the lever.</p> 
My oven door glass appears to be "tinted" or have a "rainbow" color.	The inner oven glass is coated with a heat barrier to reflect the heat back into the oven to prevent heat loss and keep the outer door cool while baking.	This is normal. Under certain light or angles, you may see this tint or rainbow color.