

JV694S – GE Profile™ Series Slide-Out Hood

Installation Information and Dimensions (in inches)

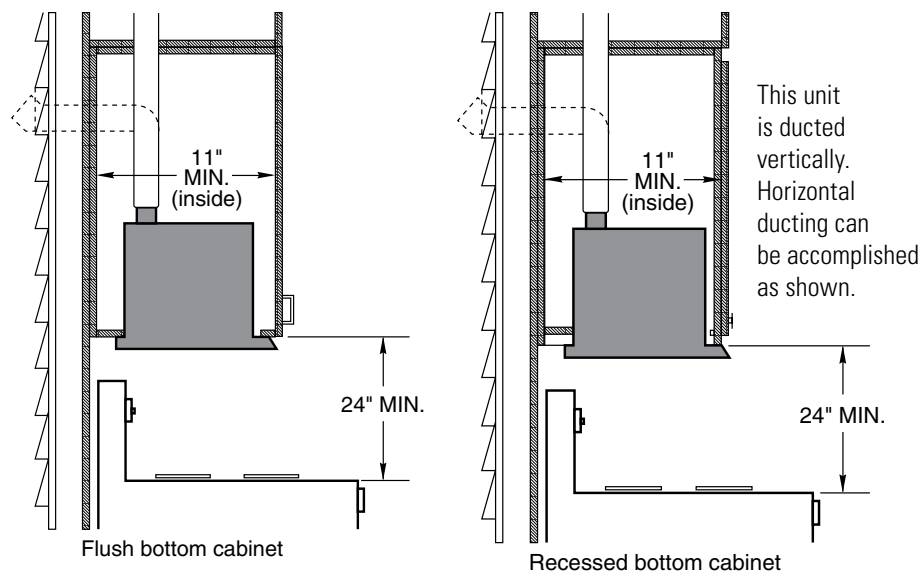
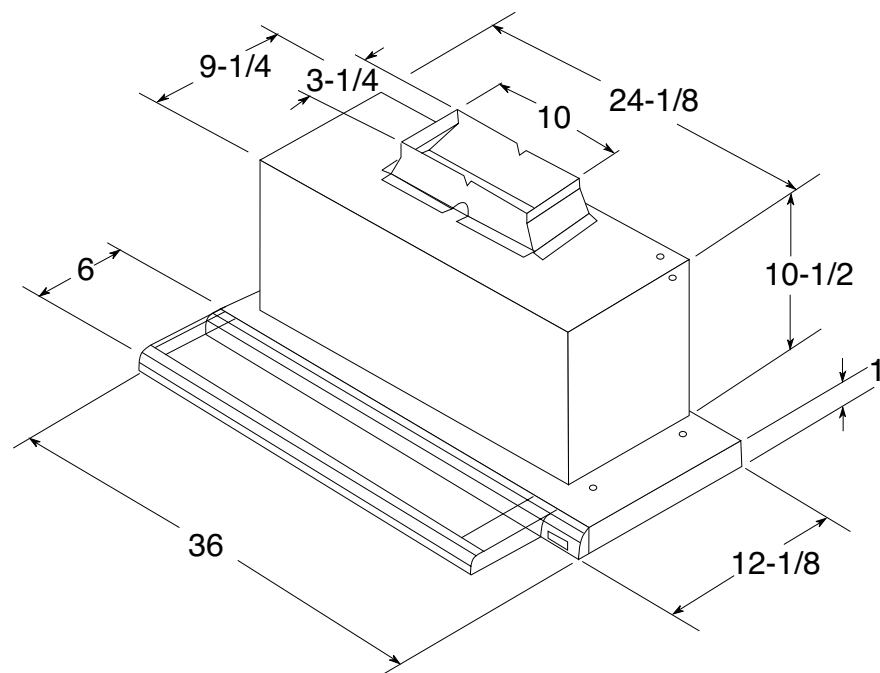

Amp Rating	
120V	3.7

Note: Remove glass visor from unit before installing hood in cabinet to protect visor from damage.

Installation Information: Before installing, consult Use & Care/installation instructions [Pub. No. 49-8463] packed with product for current dimensional data.



imagination at work

Specification Revised 3/13

220906



Listed by
Underwriters
Laboratories

For answers to your Monogram® or GE® appliance questions, visit our website at GEAppliances.com or call GE Answer Center® service, 800.626.2000.

JV694S – GE Profile™ Series Slide-Out Hood

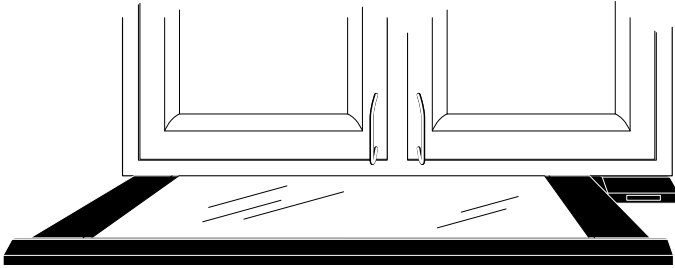

Features and Benefits

- Black on black Model
- 36" Vented Hood With Cooktop Light
- See-Through Glass Visor Slides In and Out
- 320 CFM Performance With Variable Speed Fan Control
- Auto Heat Sensor
- Compact Housing Leaves Ample Shelf Space Behind Cabinet Doors
- Vertical Exhaust With 3-1/4" x 10" Rectangular Duct
- Sones Rating: Top Exhaust – 4.5
- Also Available In White on white as Model JV695S and Bisque as in Model JV696S



imagination at work

Specification Revised 3/13

220906