

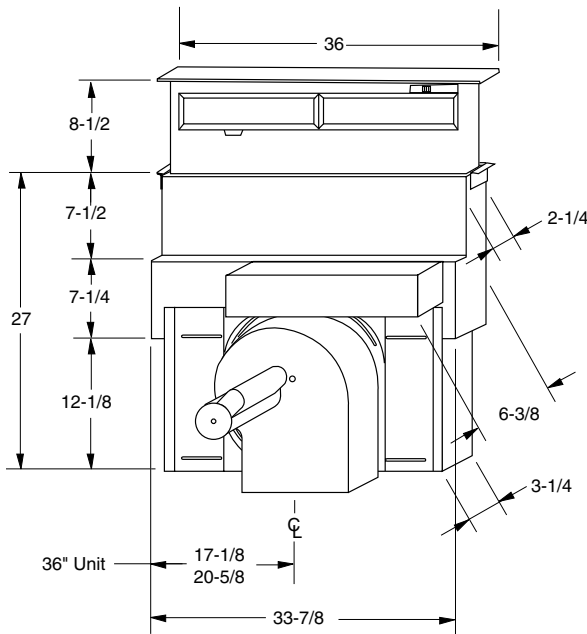

Profile™

## JVB67HBB/CC/WW – GE Profile™ 36" Telescopic Downdraft System

### Venting Options (in inches)



#### Through the Floor

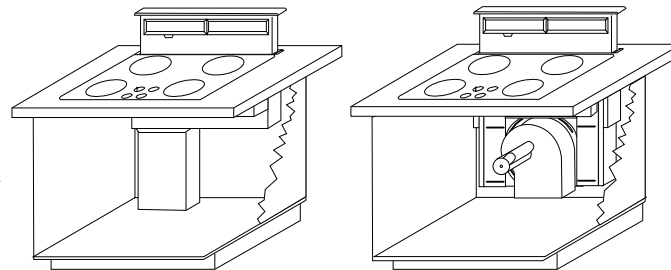

#### In Cabinet Discharge (Right)

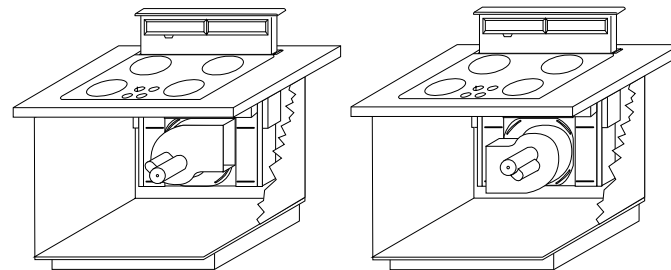

Before installing, consult installation instructions packed with product for current dimensional data.

**Note:** Telescopic downdraft vents are not recommended to be installed with cooktops that are flush mounted.

Approved for use with the following GE Profile™ and GE cooktops – 36" and 30" electric models, 36" and 30" gas sealed burner models and 36" and 30" induction models.

**Not approved for use with standard burner gas cooktops.**

**Note:** The countertop must be at least 26" deep with a flat surface area of 23-1/2" or more, front to back. In addition, other clearances to the front edge of the countertop must be considered.

**Note:** Dimensions shown are for reference only. Before cutting out countertop, refer to instructions packed with **downdraft and cooktop**.

**Note:** Installation in cabinets/countertops against the wall will not be possible in most applications. Against the wall installations are limited to dimension requirements. Refer to installation instructions packed with product for further details.

**JXBC67 Outdoor Cover.** Optional accessory may be ordered for installation of motor and blower assembly on outside wall.

**JXRB67 Indoor Remote Accessory.** Optional accessory may be ordered for installation of motor and blower assembly in an indoor remote location.

**Installation Information:** Before installing, consult installation instructions packed with product for current dimensional data.



For answers to your Monogram®, GE Profile™ or GE® appliance questions, visit our website at [GEAppliances.com](http://GEAppliances.com) or call GE Answer Center® service, 800.626.2000.



Profile™

## JVB67HBB/CC/WW – GE Profile™ 36" Telescopic Downdraft System

### Venting Duct Information

#### DUCTWORK LENGTH AND DUCT FITTINGS

**NOTE: Do not exceed 150 foot maximum permissible equivalent lengths!**

Flexible ducting: If flexible metal ducting is used, all equivalent feet values in the table should be doubled. The flexible metal duct should be straight and smooth and extended as much as possible.



**DO NOT** use flexible plastic ducting.

Add equivalent lengths for all duct pieces and transitions used to ensure that the duct run does not exceed the maximum 150 feet.

Duct Pieces	Equivalent Length*	Duct Pieces	Equivalent Length*	Duct Pieces	Equivalent Length*
6" Round Straight	1 ft. (per foot length)	3/4" x 10" 45°Elbow	8 ft.	3/4" x 10" to 6" Round Transition 90°Elbow	4 ft.
3/4" x 10" Straight	1 ft. (per foot length)	3/4" x 10" 90°Flat Elbow	33 ft.	6" Round Wall Cap with Damper	24 ft.
6" 90°Elbow	12 ft.	6" Round to 3/4" x 10" Transition	2 ft.	3/4" x 10" Wall Cap with Damper	24 ft.
6" 45°Elbow	7 ft.	3/4" x 10" to 6" Round Transition	2 ft.	6" Round Roof Cap	33 ft.
3/4" x 10" 90°Elbow	14 ft.	6" Round to 3/4" x 10" Transition 90°Elbow	4 ft.		

#### SHOULD NOT EXCEED 150 EQUIVALENT FEET

\*Equivalent lengths of duct pieces are based on actual tests conducted by GE Evaluation Engineering and reflect requirements for good venting performance. See chart for CFM Duct Length.

### Plan the Ductwork

1. This downdraft blower system is designed for use with 3-1/4" x 10" ductwork (can be transitioned to 6" round). Two different discharge directions are available with side-to-side adjustment for the accurate alignment of ductwork.
2. For best performance: choose the ducting option which allows the shortest length of ductwork and a minimum number of elbows and transitions. Check location of floor joists, wall joists, wall studs, electrical wiring or plumbing for possible interference.

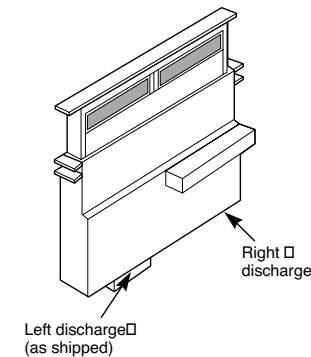

Listed by  
Underwriters  
Laboratories

For answers to your Monogram® GE Profile™ or GE® appliance questions, visit our website at [GEAppliances.com](http://GEAppliances.com) or call GE Answer Center® service, 800.626.2000.



*Profile™*

## JVB67HBB/CC/WW – GE Profile™ 36" Telescopic Downdraft System

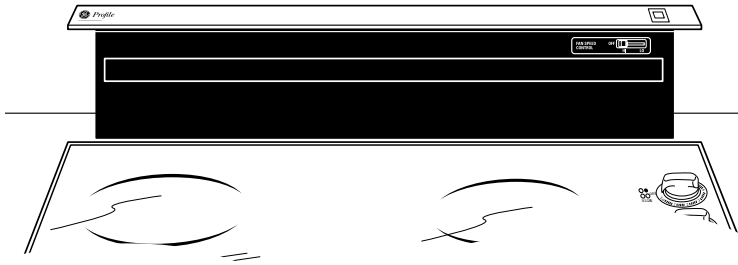

### Features and Benefits

- Telescopic downdraft hood – Hood raises over cooktop surface and retracts when not in use
- 390-CFM – Powerful 390-CFM performance removes smoke and vapors from the cooking area
- Variable speed fan control – The powerful variable speed exhaust system effectively pulls smoke and vapors out of the kitchen
- Removable grease filter – Durable filters can be removed for easy cleaning and maintenance
- Model JVB67HWW – White on white
- Model JVB67HBB – Black on black
- Model JVB67HCC – Bisque on bisque