



Washer/Dryer

Safety Instructions 2-5

Operating Instructions

Care and Cleaning
of the Dryer 12

Care and Cleaning
of the Washer..... 9

Control Panel Dryer 10

Control Panel Washer..... 6

Control Settings Dryer..... 10

Control Settings Washer 6, 7

Features Washer..... 8

Loading and Using
the Dryer..... 13

Loading and Using
the Washer 9

Troubleshooting

Troubleshooting Washer.....14-16

Troubleshooting Dryer 17, 18

Consumer Support

Consumer Support..... 20

Warranty..... 19

Owner's Manual

GUD24
GUD27

English/Français/Español

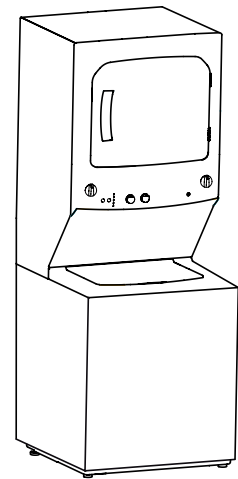

Write the model and serial number here:

Model # _____

Serial # _____

Open Dryer door for Model and Serial number tag.



189D7218P003
49-90532 11-14 GE Printed in Mexico

IMPORTANT SAFETY INFORMATION.

READ ALL INSTRUCTIONS BEFORE USING.

 This is the safety alert symbol. This symbol alerts you to potential hazards that can kill you or hurt you and others. All safety messages will follow the safety alert symbol and the word "DANGER", "WARNING", or "CAUTION". These words are defined as:

 **DANGER** Indicates a hazardous situation which, if not avoided, **will** result in death or serious injury.

 **WARNING** Indicates a hazardous situation which, if not avoided, **could** result in death or serious injury.

 **CAUTION** Indicates a hazardous situation which, if not avoided, **could** result in minor or moderate injury.

IMPORTANT SAFETY INSTRUCTIONS

 **WARNING** To reduce the risk of death, fire, explosion, electric shock, or injury to persons when using your appliance, follow basic precautions, including the following:

- Read all instructions before using the appliance.
- DO NOT wash or dry articles that have been previously cleaned in, washed in, soaked in or spotted with gasoline, dry-cleaning solvents, or other flammable or explosive substances, as they give off vapors that could ignite or explode.
- DO NOT place items exposed to cooking oils in your dryer. Items contaminated with cooking oils may contribute to a chemical reaction that could cause a load to catch fire.
- DO NOT add gasoline, dry-cleaning solvents, or other flammable or explosive substances to the wash water. These substances give off vapors that could ignite or explode.
- Under certain conditions, hydrogen gas may be produced in a hot-water system that has not been used for 2 weeks or more. HYDROGEN GAS IS EXPLOSIVE. If the hot water system has not been used for such a period, before using a washing machine, turn on all hot-water faucets and let the water flow from each for several minutes. This will release any accumulated hydrogen gas. As the gas is flammable, DO NOT smoke or use an open flame during this time.
- DO NOT allow children to play on or in this appliance. Close supervision of children is necessary when this appliance is used near children. Before the appliance is removed from service or discarded, remove the door and lid to the drying and washing compartments. Failure to follow these instructions may result in death or injury to persons.
- DO NOT reach into the appliance if the drum, tub or agitator is moving to prevent accidental entanglement.
- DO NOT use heat to dry articles containing foam rubber or similarly textured rubber-like materials.
- Clean lint screen before or after each load. DO NOT operate the dryer without the lint filter in place.
- DO NOT use fabric softeners or products to eliminate static unless recommended by the manufacturer of the fabric softener or product.
- Do not store combustible materials, gasoline or other flammable liquids near the dryer. Keep area around the exhaust opening and adjacent surrounding areas free from the accumulation of lint, dust and dirt. Keep dryer area clear and free from items that would obstruct the flow of combustion and ventilation air.
- The interior of the appliance and exhaust duct should be cleaned periodically by qualified service personnel.
- DO NOT install or store this appliance where it will be exposed to the weather.
- DO NOT tamper with controls, repair or replace any part of this appliance or attempt any servicing unless specifically recommended in the user maintenance instructions or in published user repair instructions that you understand and have the skills to carry out.
- DO NOT operate this appliance if it is damaged, malfunctioning, partially disassembled, or has missing or broken parts including a damaged cord or plug.

IMPORTANT SAFETY INSTRUCTIONS

- Unplug the appliance or turn off the circuit breaker before servicing. Pressing the **Power** or **Start/Pause** button DOES NOT disconnect power.
- DO NOT spray any type of aerosol into, on or near appliance, at any time. Do not use any type of spray cleaner when cleaning dryer interior. Hazardous fumes or electrical shock could occur.
- Do not store items that may burn or melt (such as clothing, paper material, plastics or plastic containers, etc) on top of the appliance nor hang them from the door.
- Never climb on or stand on this stacked unit.
- See "Electrical Requirements" located in the Installation Instructions for grounding instructions.

SAVE THESE INSTRUCTIONS

ADDITIONAL GAS DRYER WARNINGS



WARNING

For your safety, the information in this manual must be followed to minimize the risk of fire or explosion or to prevent damage, personal injury, or death.

- DO NOT store or use gasoline or other flammable vapors and liquids in the vicinity of this or any other appliance.
- WHAT TO DO IF YOU SMELL GAS:
 - DO NOT try to light any appliance.
 - DO NOT touch any electrical switch; DO NOT use any phone in your building.
 - Clear the room, building, or area of any occupants.
 - Immediately call your gas supplier from a neighbor's phone. Follow the gas supplier's instructions.
 - If you cannot reach your gas supplier, call the fire department.
- Installation and service must be performed by a qualified installer, service agency, or the gas supplier.

State of California Proposition 65 Warnings:

The California Safe Drinking Water and Toxic Enforcement Act requires the governor of California to publish a list of substances known to the state to cause cancer, birth defects or other reproductive harm and requires businesses to warn of potential exposure to such substances.



WARNING

This product contains one or more chemicals known to the State of California to cause cancer, birth defects or other reproductive harm.

Gas appliances can cause low-level exposure to some of these substances, including benzene, carbon monoxide, formaldehyde and soot, caused primarily by the incomplete combustion of natural gas or LP fuels. Exposure to these substances can be minimized by properly venting the dryer to the outdoors.

SAVE THESE INSTRUCTIONS

IMPORTANT SAFETY INFORMATION. READ ALL INSTRUCTIONS BEFORE USING.

PROPER INSTALLATION



This washer must be properly installed and located in accordance with the Installation Instructions before it is used. If you did not receive an Installation Instructions, you can receive one by visiting GEAppliances.com or by calling **800.GE.CARES** (800.432.2737). In Canada, visit www.geappliances.ca or call **800.561.3344**.

- Ensure that the hot water hose is connected to the “H” valve and the cold water hose is connected to the “C” valve.
- Install or store where it will not be exposed to temperatures below freezing or exposed to the weather, which could cause permanent damage and invalidate the warranty.
- Properly ground washer to conform with all governing codes and ordinances. Follow details in Installation Instructions.

WARNING - Electrical Shock Hazard

Plug into a grounded 3 prong outlet.

DO NOT remove ground prong.

DO NOT use an adapter.

DO NOT use an extension cord.

Failure to do so can result in death, fire or electrical shock.

- This washer does include water supply hoses.

GE strongly recommends the use of factory specified parts. A list of factory hoses available for purchase are listed below. These hoses are manufactured and tested to meet GE specifications.

GE strongly recommends the use of new water supply hoses. Hoses degrade over time and need to be replaced every 5 years to reduce the risk of hose failures and water damage.

Parts and Accessories

Order on-line at GEApplianceparts.com today, 24 hours a day or by phone at 800.626.2002 during normal business hours. In Canada, visit your local GE parts distributor or call 800.661.1616.

Part Number	Accessory
PM14X10002	4 ft Rubber Water Supply Hoses
Or	
PM14X10005	4 ft Braided Metal Water Supply Hoses
WX10X10011	Tide® Washing Machine Cleaner*
PM7X1	Washer Floor Tray

WASHER CAPACITY:

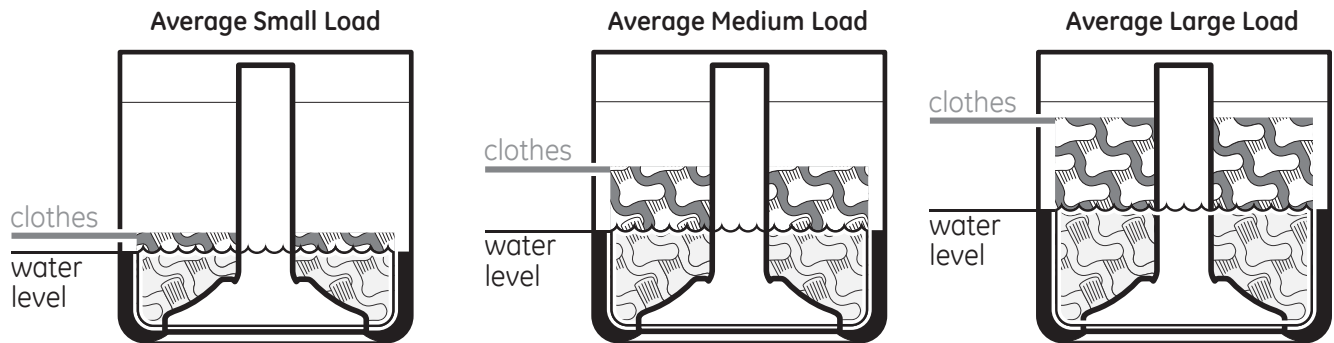

WHEN NOT IN USE

- Turn off water faucets to minimize leakage if a break or rupture should occur. Check the condition of the fill hoses; GE recommends changing the hoses every 5 years.

SAVE THESE INSTRUCTIONS

About the Washer control panel.

Quick Start Guide

STEP 1

- Add detergent
- Add fabric softener (optional)
- Add bleach (optional).

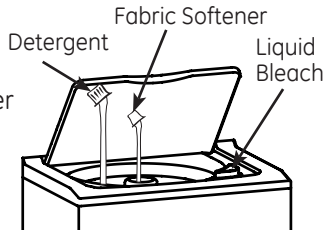

STEP 2

- Add clothes



STEP 3

- Select load size and other wash options
- Select wash cycle

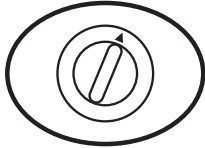

STEP 4

- Close lid
- Push **Start**



LID LOCKED

Your washer has a security system that prevents opening the lid during the spin cycle. The lid lock prevents anyone (especially children) from reaching into the washer while the basket is spinning. The lid lock will be released within 5 seconds after the basket stop spinning.

Trying to open the lid while locked could result in injuries. If the lid does not unlock after spinning, please contact service.

NOTE: If there is a power outage the lid lock can take 3 minutes to release.

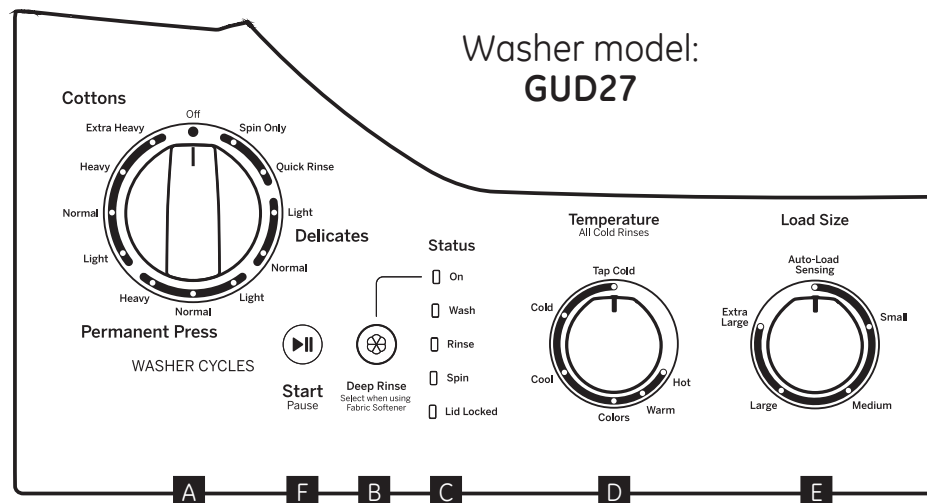
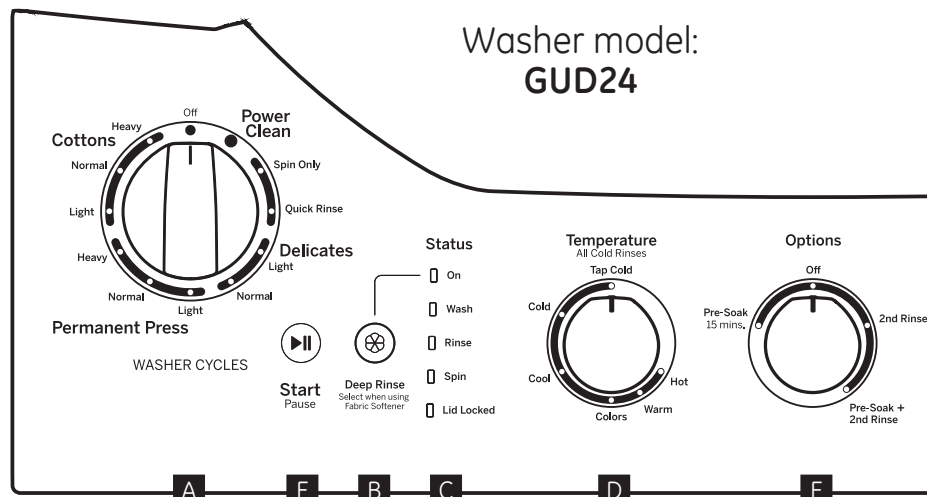

Note: This appliance is designed so that the washer and dryer can be operated at the same time.

A Wash Cycle Selector

The wash cycle controls the length and intensity of the washing process. The knob can be turned in either direction. Turning the Cycle Selector knob after starting a cycle will stop the washer and reset the cycle to the new selection. Press **Start** to begin the new cycle selection.

The chart below will help you match the wash cycle setting with your clothing. The chart is ranked from longest to shortest cycle time and wash intensity. (Cycles vary by model.)

Power Clean - Uses more water than standard wash cycles. It is recommended for extra-large loads and heavily soiled clothes.

Cottons - For heavy to lightly soiled cottons, household linens, work and play clothes.

Permanent Press - For wrinkle-free and permanent press items, and knits.

Delicates - For lingerie and special-care fabrics with light to normal soil.

Quick Rinse - Rinses and spins non-soiled items where a rinse only is desired.

Spin Only - For draining the tub and spinning water out of clothes.

Off - Washer is turned off and the **Start** button does not function.

NOTE: When the control is turned to OFF, the **Status** lights are off.

NOTE: The cycle selector does not rotate during the operation of the washer.

B Deep Rinse

Set this option when adding fabric softener to the washer.

C Status lights

The **Status** lights show the stage the washer is in. When the selector knob is set to a new cycle, the **Status** lights will flash momentarily, showing the stages the cycle will go through.

Status light	Illuminates
On	When the fabric softener option has been selected.
Wash	When the washer is in the wash portion of the cycle.
Rinse	When the washer is in the rinse portion of the cycle.
Spin	When the washer draining and/or spinning.
Lid Locked	When the washer lid is locked. This feature prevents the lid from being opened while the washer is in the spin cycle or coasting to a stop.

NOTE: If the **Status** lights are blinking, the operation of the washer has been paused. To resume operation press the **Start** button (the lid must be closed).

D Temperature

Select the water temperature for the wash cycle (all rinses use cold water). Always follow fabric manufacturer's care label or instructions when laundering.

Tap Cold* uses incoming tap water, which can provide energy savings. For all other temperature selections, a mixture of hot and cold water is used to achieve the ideal temperature for each temperature setting.

Please note that some detergents do not fully dissolve in very cold water. If you experience this, it is recommended you choose a setting other than **Tap Cold.*

E Load Size

Loosely load clothes no higher than the top row of holes in the washer basket.

Auto Load Sensing- This selection automatically provides the correct amount of water suited to the size and type of load placed in the unit.

F Start

Press **Start** to begin the cycle. With the lid closed pressing **Start** again will pause the cycle and **Status** lights will blink. To continue the cycle, close the lid and press **Start** again. The water fill will continue with the lid opened, except when **Auto Load Sensing** is selected as the load size. (The lid **must be closed** to continue filling when **Auto Load Sensing** is selected.)

If the lid is opened during the cycle, the cycle will pause and the **Status** lights will blink. To resume the cycle, close the lid and press **Start**.

If the machine is paused for more than 24 hours, the cycle will be cancelled. To stop the cycle, turn the Cycle Selector to the **Off** position.

About the Washer features.



The Fabric Softener Dispenser

The *fabric softener dispenser* automatically releases liquid fabric softener at the proper time during the cycle.

Do not stop the washer during the first spin. This will cause the dispenser to empty too soon.

To use, follow these steps:

- 1 Make sure dispenser is securely attached to .
- 2 Use only diluted liquid fabric softener. Pour into dispenser, using amount recommended on package.

Never pour fabric softener directly on clothes. It may stain them.

NOTE: Do **not** pour bleach into **FABRIC SOFTENER** dispenser.

- 3 Add water to dispenser until it reaches the maximum fill line.



Do not pour anything into the agitator if the dispenser is removed.

- 4 Select **FABRIC SOFTENER** button on control panel for proper dispersion of the fabric softener.

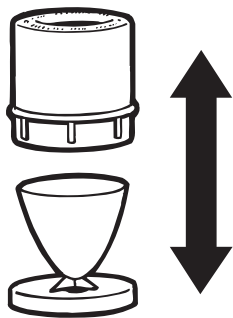

Separate for cleaning

Cleaning the Fabric Softener Dispenser

- 1 Remove the dispenser from the top of the agitator.
- 2 Separate the dispenser cup from the cover by grasping the top and pushing down on the inside of the cup with your fingers. Dispenser cup will pop free from the cover.
- 3 To clean the dispenser, soak both the dispenser cup and the dispenser cover in the following solution:
 - 1 US gallon (3.8 liters) warm water
 - 1/4 cup (60 ml) heavy-duty liquid detergent
 - 1 cup (240 ml) bleach
- 4 If necessary, loosen buildup with a clean, soft cloth after soaking. Do not use a stiff brush; you may roughen the surface of the dispenser.
- 5 Rinse and reassemble dispenser. Place dispenser back on the agitator.

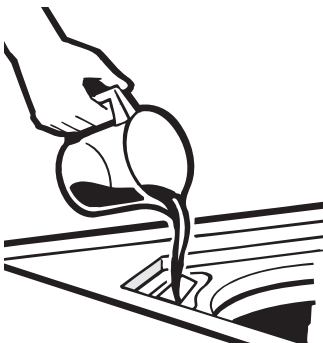

Liquid Bleach Funnel

The water fill dilutes liquid chlorine bleach as the washer fills for the wash cycle.

- 1 Check clothing care labels for special instructions.
- 2 Measure liquid bleach carefully, following instructions on the bottle.
 - Never pour undiluted liquid chlorine bleach directly onto clothes or into the wash basket.
 - Do not pour powdered bleach into bleach funnel.
- 3 Before starting the washer, pour measured amount of bleach directly into bleach funnel. Avoid splashing or over-filling dispenser. If you prefer to use powdered bleach, add it into the wash basket with your detergent.
 - Do not mix chlorine bleach with ammonia or acids such as vinegar and/or rust remover. Mixing can produce a toxic gas which may cause death.

NOTE: Do **not** pour bleach into **FABRIC SOFTENER** dispenser.

Loading and using the washer.

Always follow fabric manufacturer's care label when laundering.

GEAppliances.com



Sorting Wash Loads

Sort by color (whites, lights, colors), soil level, fabric type (sturdy cottons, easy care, delicates) and whether the fabric produces lint (terry cloth, chenille) or collects lint (velveteen, corduroy).

⚠ WARNING



- Fire Hazard

Never place items in the washer that are dampened with gasoline or other flammable liquids.

No washer can completely remove oil.

Do not dry anything that has ever had any type of oil on it (including cooking oils).

Doing so can result in death, explosion, or fire.



Loading the Washer

Load dry items loosely, no higher than the top row of holes in the washer basket. When loading wet items, make sure you set the load/water level high enough to allow the items to move freely. Water level should just cover the clothes. To add items after washer has started, lift the lid and submerge additional items next to the agitator.

- Do not wrap long items like sheets or pants around the agitator.
- Do not wash fabrics containing flammable materials (waxes, cleaning fluids, etc.).
- Agitation will not start with the lid up.



Proper Use of Detergent

Add detergent and start the washer before adding clothes so that the detergent can work effectively. Using too little or too much detergent is a common cause of laundry problems.

You can use less detergent if you have soft water, a smaller load or a lightly soiled load.

Care and cleaning of the washer.



Wash Basket: Leave the lid open after washing to allow moisture to evaporate. If you want to clean the basket, use a clean soft cloth dampened with liquid detergent; then rinse. (Do not use harsh or gritty cleaners.)

Fill Hoses: GE recommends changing the hoses every 5 years.

Exterior: Immediately wipe off any spills. Wipe with damp cloth. Try not to hit surface with sharp objects.

Moving and Storage: Ask the service technician to remove water from drain pump and hoses. See the Installation Instructions packed with product for information on how to reinstall the shipping rod to keep the tub stationary when moving the washer. For more information, visit GEAppliances.com or call 800.GE.CARES (800.432.2737).

In Canada, visit GEAppliances.ca or call 800.561.3344. Do not store the washer where it will be exposed to the weather.

Long Vacations: Be sure water supply is shut off at faucets. Drain all water from hoses if weather will be below freezing.

About the Dryer control panel.

⚠ WARNING!

To reduce the risk of fire, electric shock, or injury to persons, read the **IMPORTANT SAFETY INSTRUCTIONS** before operating this appliance.

⚠ WARNING



Explosion Hazard

Keep flammable materials and vapors, such as gasoline, away from dryer.
DO NOT dry anything that has ever had anything flammable on it (even after washing).
 Failure to do so can result in death, explosion, or fire.

⚠ WARNING



Fire Hazard

No washer can completely remove oil.
 Do not dry anything that has ever had any type of oil on it (including cooking oils).
 Items containing foam, rubber, or plastic must be dried on a clothesline or by using an air dry cycle.
 Failure to follow these instructions can result in death or fire.

Throughout this manual, features and appearance may vary from your model.

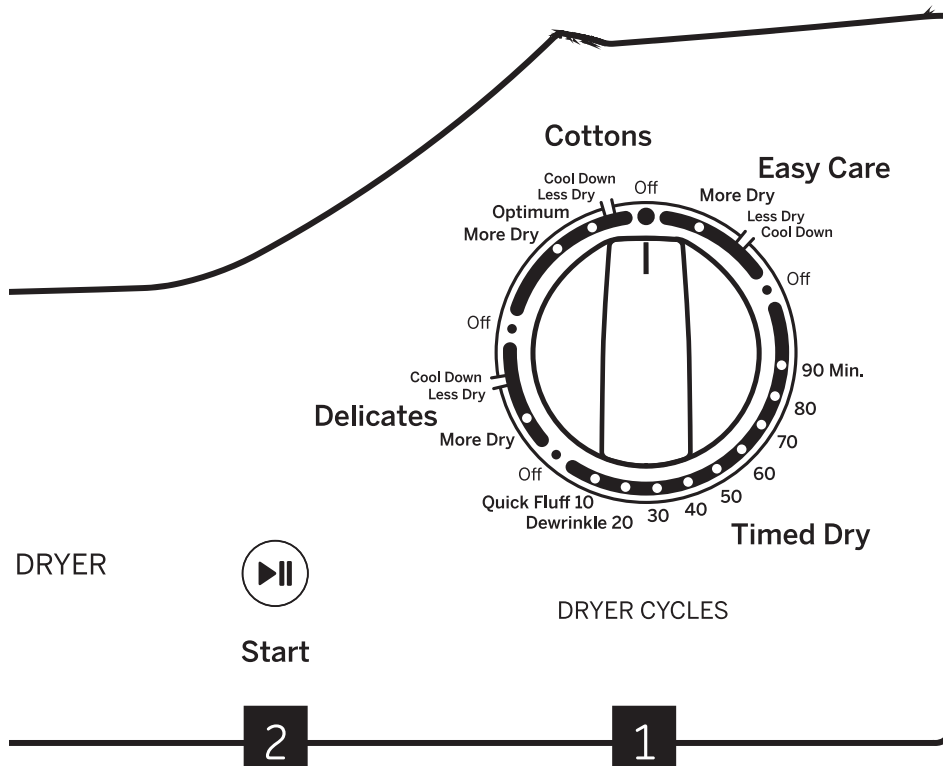

Note: This appliance is designed so that the washer and dryer can be operated at the same time.

IMPORTANT: Clean the lint filter each time you use the dryer

1

Fabric Care/Temperature

Cottons	For regular to heavy cottons.
Delicates	For delicates, synthetics and items labeled tumble dry low.
EASY Care	For synthetics, blends, delicates and items labeled permanent press.
Quick Fluff	For <i>fluffing</i> items without heat. Use the Timed Dry cycle.

Drying Cycles

Cottons	For cottons and most linens. For most loads, select Optimum Dry .
Delicates	For delicate items, special-care fabrics and knits.
Easy Care	For wrinkle-free, permanent press and delicate items, and knits.
Timed Dry	Set the Cycle Selector at the desired drying time.
Dewrinkle	For removing wrinkles from items that are clean and dry or that are very lightly damp.
Quick Fluff	For freshening or fluffing up already dry clothing, fabrics, linens and pillows. Use with Fluff No Heat . Provides 10 minutes of no heat tumbling.

Automatic cycles determine fabric dryness and provide automatic sensed drying. The timer does not rotate during the cycle until the thermostats sense that the clothes are dry, then the timer rotates automatically to **Off**. Select **Less Dry** if you want your clothes slightly damp at the end of the drying cycle. Select **More Dry** if you want them to feel drier. Timed cycles run for a selected time.

Timed Cycle

Timed Dry	For manual drying. The timer rotates during the entire cycle.
-----------	---

2

Start-Close the dryer door. Press **Start**. Opening the door during operation will stop the dryer. To restart the dryer, close the door and select **Start** to complete the cycle.

Care and Cleaning of the Dryer.



The Exterior: Wipe or dust any spills or washing compounds with a damp cloth. Dryer control panel and finishes may be damaged by some laundry pretreatment soil and stain remover products. Apply these products away from the dryer. The fabric may then be washed and dried normally. Damage to your dryer caused by these products is not covered by your warranty.

The Lint Filter: Clean the lint filter before each use. Slide out the grid that covers the filter. Run your fingers across the filter. A waxy buildup may form on the lint filter from using dryer-added fabric softener sheets. To remove this buildup, wash the lint screen in warm, soapy water. Dry thoroughly and replace. Do not operate the dryer without the lint filter and grid in place. Have a qualified technician vacuum the lint from the dryer once a year.

Dryer Interior and Duct: The interior of the appliance and exhaust duct should be cleaned once a year by qualified service personnel.

The Exhaust Duct: Inspect and clean the exhaust ducting at least once a year to prevent clogging. A partially clogged exhaust can lengthen the drying time.

Follow these steps:

1. Turn off electrical supply by disconnecting the plug from the wall socket.
2. Disconnect the duct from the dryer.
3. Vacuum the duct with the hose attachment and reconnect the duct.

The Exhaust Hood: Check with a mirror that the inside flaps of the hood move freely when operating. Make sure that there is no wildlife (birds, insects, etc.) nesting inside the duct or hood.

Model: **GUD24**

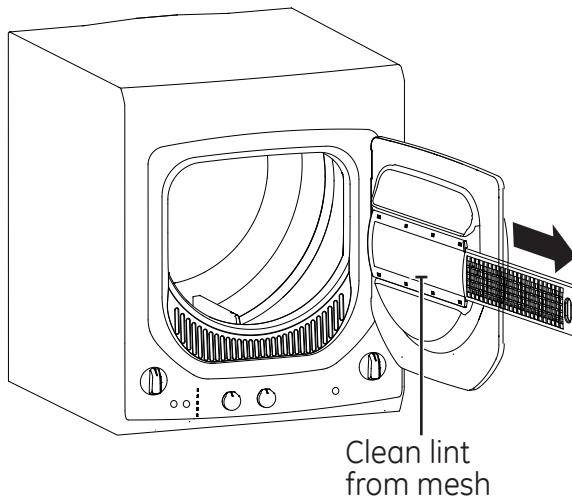

Model: **GUD27**

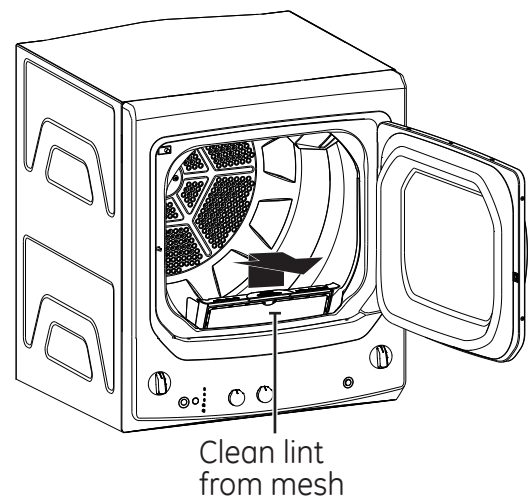



Venting the Dryer

For the best drying performance, the dryer needs to be properly vented. The dryer will use more energy and run longer if it is not vented to the specifications below. Carefully follow the details on Exhausting in the Installation Instructions.

⚠ WARNING  - Fire Hazard

- This dryer **MUST** be exhausted to the outdoors.
- Use only 4" rigid metal ducting for the home exhaust duct.
- Use only 4" rigid metal or UL-listed dryer transition duct to connect the dryer to the home exhaust.
- DO NOT** use a plastic vent.
- DO NOT** use a metal foil vent.
- DO NOT** exhaust into a chimney, kitchen exhaust, gas vent, wall, ceiling, attic, crawl space, or concealed space of a building.
- DO NOT** install a screen in or over the exhaust duct.
- DO NOT** use duct longer than specified in the exhaust length table.
- Failure to follow these instructions can result in death or fire.

Correct Venting

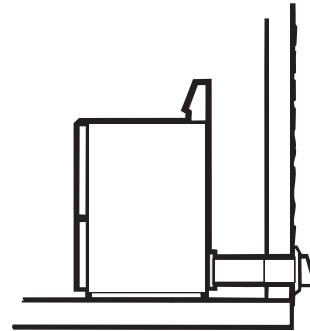
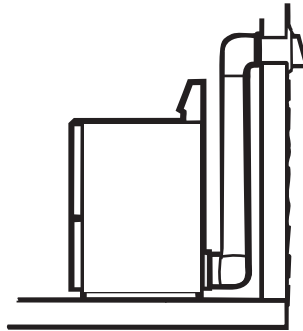

Incorrect Venting

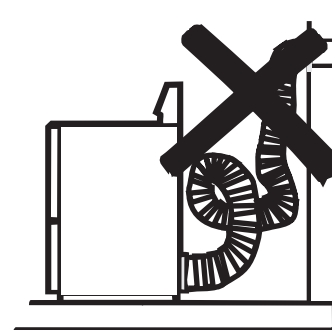
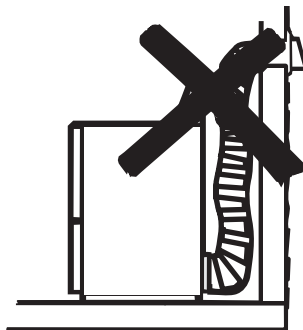

Before you call for service...



Troubleshooting Tips

Save time and money! Review the charts on the following pages, or visit GEAppliances.com.

In Canada, visit GEAppliances.ca. You may not need to call for service.

<i>Water</i>	<i>Possible Causes</i>	<i>What to do</i>
<i>Too many suds</i>	Too much detergent	Measure your detergent carefully. Use less soap if you have soft water, a smaller load or a lightly soiled load.
<i>Water leaks</i>	Using too much detergent	Use less detergent. Use less soap if you have soft water, a smaller load or a lightly soiled load.
	Fill hoses or drain hose is improperly connected	Make sure hose connections are tight at faucets and rubber washers are installed. Make sure end of drain hose is correctly inserted in and secured to drain facility.
	Household drain may be clogged	Check household plumbing. You may need to call a plumber.
	Constant water pressure to the fill hoses at the water source	Tighten hoses at the faucets and turn the water off after each use. Check condition of the fill hoses; they should be replaced every 5 years.
<i>Water temperature seems incorrect</i>	Cooler water temperatures provide improved energy efficiency	New laundry detergents have been formulated to work with cooler water temperatures without affecting wash performance.
	Water supply is turned off or improperly connected	Turn both hot and cold faucets fully on and make sure hoses are connected to correct faucets.
	Water valve screens are stopped up	Turn off the water source and remove the water connection hoses from the upper back of the washer. Use a brush or toothpick to clean the screens in the machine. Reconnect the hoses and turn the water back on.
	House water heater is not set properly	Make sure house water heater is delivering water at 120°F–140°F (48°C–60°C).
<i>Water pumped out before cycle is complete</i>	Lid lifted or cycle was put in pause for over 24 hours	Reset cycle.
<i>Water won't drain</i>	Drain hose is kinked or improperly connected	Straighten drain hose and make sure washer is not sitting on it. Top of drain outlet should be less than 8 ft (2.5 m) above floor.
<i>Washer pauses during spin cycle</i>	This is normal	The washer may pause during the spin cycle to remove soapy water more efficiently.
<i>Can hear but not see water at the end of the cycle</i>	This is normal	The pump leaves a little water in its intake and this is diluted with clean rinse water.

Washer Operation	Possible Causes	What to do
Washer won't operate	Washer is unplugged	Make sure cord is plugged securely into a working outlet.
	Water supply is turned off	Turn both hot and cold faucets fully on.
	Controls are not set properly	Check controls.
	Lid is open—safety feature prevents agitation and spinning when lid is up	Close lid and reset cycle, to the beginning if necessary.
	Circuit breaker/fuse is tripped/blown	Check house circuit breakers/fuses. Replace fuses or reset breaker. Washer should have separate outlet.
	Electronics need to be reset	Unplug washer, wait 2 minutes, plug back in and press Start .
	Start was not pressed	Press Start .
	Lid magnet missing	Call for service.
Movement inside machine when shut off	Shifting mechanism is disengaging the motor	When the machine is manually turned off, the shifter will disengage the motor before completely shutting down. If lid is raised before the motor is disengaged, it will resume when lid is closed.
Washer Performance	Possible Causes	What to do
Clothes too wet	Incorrect spin cycle selected	Make sure the spin cycle selected matches the load you are washing. Some fabrics will feel wetter when rinsed with cold water.
Colored spots	Incorrect use of fabric softener	Check fabric softener package for instructions and follow directions for using dispenser. Pretreat stain and rewash.
	Dye transfer	Sort whites or lightly colored items from dark colors
Grayed or yellowed clothes	Not enough detergent	Use more detergent (especially with larger loads). Be sure to follow detergent manufacturer's directions.
	Hard water	Use a water conditioner like Calgon brand or install a water softener.
	Water is not hot enough	Make sure water heater is delivering water at 120°F–140°F (48°C–60°C).
	Washer is overloaded	Select load size to match clothes load.
	Detergent is not dissolving	Add detergent as wash basket fills with water before you load clothes.
	Dye transfer	Sort clothes by color. If fabric label states wash separately, unstable dyes may be indicated.
Lint or residue on clothes	Clothes are air or line dried	If you do not dry your clothes with a clothes dryer, your clothes may retain more lint.
	Incorrect sorting	Separate lint producers from lint collectors.
	Washing too long	Wash small loads for a shorter time than larger loads
	Detergent not dissolving	Add detergent as wash basket fills with water, before you load clothes.
		Try a liquid detergent. Use warmer water temperature.
	Overloading	Load clothes no higher than the top row of holes in the washer basket.
	Incorrect use of fabric softener	Check fabric softener package for instructions and follow directions for using dispenser.

Before you call for service...

Washer Performance	Possible Causes	What to do
Pilling	Result of normal wear on poly-cotton blends and fuzzy fabrics	While this is not caused by the washer, you can slow the pilling process by washing garments inside out.
Snags, holes, tears, rips or excessive wear	Pins, snaps, hooks, sharp buttons, belt buckles, zippers and sharp objects left in pockets	Fasten snaps, hooks, buttons and zippers. Remove loose items like pins, objects in pockets and sharp buttons. Turn knits (which snag easily) inside out.
	Undiluted chlorine bleach	Check bleach package instructions for proper amount. Never add undiluted bleach to wash or allow clothes to come in contact with undiluted bleach.
	Chemicals like hair bleach or dye, permanent wave solution	Rinse items that may have chemicals on them before washing.
Wrinkling	Improper sorting	Avoid mixing heavy items (like work clothes) with light items (like blouses). Try a fabric softener.
	Overloading or incorrect water level	Load your washer so clothes have enough room to move freely with water covering all of the clothes.
	Incorrect wash and dry cycles	Match Cycle selection to the type of fabric you are washing (especially for easy care loads).
	Repeated washing in water that is too hot	Wash in warm or cold water.
Washer Sounds	Possible Causes	What to do
"Metallic clicking"	Shifter mechanism is engaging or disengaging	The drive system will engage at the start of agitate and disengage when agitate is complete. This occurs multiple times during the wash.
Back and forth "swoosh" or light "clicking" sound during agitate	Electric motor reversing direction	This machine has a drive system that doesn't use gears. This sound is the motor rotating back and forth to agitate your laundry.
Quick short agitation sounds at end of agitate	Clothing redistribution	At the end of agitate, the motor makes short agitation strokes to redistribute the load.
"Click" when water stops filling	Relay switch	The relay makes a click sound when activated. The water level activates the relay and stops filling.
"Clicking" behind Control Panel during fill	Automatic Temperature Control Valve	This valve mixes in cold and hot water. The "clicking" is the valve turning on and off.
Water volume changes during fill	Automatic Temperature Control Valve	This valve mixes in cold and hot water. The sound changes when the valves are turned on and off.
Motor "whining up" or "coasting down" in spin	Motor ramping up/down during spin cycle	The motor will speed up incrementally during the spin cycle. When spin is complete, it will coast until it stops.
"Humming"	Water drain pump	The drain pump will make a humming sound when pumping out water after agitation stops and continue until spin is complete.
"Gurgling"	Water drain pump	When the pump starts drawing in air, it starts to gurgle. The washer should then begin spinning and the sound will continue until it is done spinning.

Dryer Problem	Possible Causes	What to do
Dryer doesn't start	Dryer is unplugged	Make sure the dryer plug is pushed completely into the outlet.
	Fuse is blown/circuit breaker is tripped	Check the house fuse/circuit breaker box and replace fuse or reset breaker. Note: Most electric dryers use 2 fuses/breakers.
Dryer doesn't heat	Fuse is blown/circuit breaker is tripped; the dryer may tumble but not heat	Check the house fuse/circuit breaker box and replace both fuses or reset both breakers. Your dryer may tumble if only one fuse is blown or one breaker tripped.
	Gas service is off	Make sure gas shutoff at dryer and main shutoff are fully open.
Dryer shakes or makes noise	Some shaking/noise is normal. Dryer may be sitting unevenly	Move dryer to an even floor space, or adjust leveling legs as necessary until even.
Greasy spots on clothes	Improper use of fabric softener	Follow directions on fabric softener package.
	Drying dirty items with clean ones	Use your dryer to dry only clean items. Dirty items can stain clean items and the dryer.
	Clothes were not completely clean	Sometimes stains which cannot be seen when the clothes are wet appear after drying. Use proper washing procedures before drying.
Lint on clothes	Lint filter is full	Clean lint screen before each load.
	Improper sorting	Sort lint producers (like chenille) from lint collectors (like corduroy).
	Static electricity can attract lint	See suggestions in this section under STATIC.
	Overloading	Separate large loads into smaller ones.
	Paper, tissue, etc. left in pockets	Empty all pockets before laundering clothes.
Static occurs	No fabric softener was used	Try a fabric softener.
		Bounce® Fabric Conditioner Dryer Sheets have been approved for use in all GE Dryers when used in accordance with the manufacturer's instructions.
	Overdrying	Try a fabric softener.
		Adjust setting to Less Dry .
Synthetics, permanent press and blends can cause static	Try a fabric softener.	
Inconsistent drying times	Type of heat	Automatic drying times will vary according to the type of heat used (electric, natural or LP gas), size of load, types of fabrics, wetness of clothes and condition of exhaust ducts.

Before you call for service...

Dryer Problem	Possible Causes	What to do
<i>Clothes take too long to dry</i>	Improper sorting	Separate heavy items from lightweight items (generally, a well-sorted washer load is a well-sorted dryer load).
	Large loads of heavy fabrics (like beach towels)	Large, heavy fabrics contain more moisture and take longer to dry. Separate large, heavy fabrics into smaller loads to speed drying time.
	Controls improperly set	Match control settings to the load you are drying.
	Lint filter is full	Clean lint filter before every load.
	Improper or obstructed ducting	Check installation instructions for proper ducting/venting.
		Make sure ducting is clean, free of kinks and unobstructed.
		Check to see if outside wall damper operates easily.
	Check the Installation Instructions to make sure the dryer venting is correct.	
Blown fuses or tripped circuit breaker	Replace fuses or reset circuit breakers. Since most dryers use 2 fuses/breakers, make sure both are operating.	
Overloading/combining loads	Do not put more than one washer load in the dryer at a time.	
Underloading	If you are drying only one or two items, add a few items to ensure proper tumbling.	
<i>Clothes are wrinkled</i>	Overdrying	Select a shorter drying time.
		Remove items while they still hold a slight amount of moisture. Select a Less Dry setting.
	Letting items sit in dryer after cycle ends	Remove items when cycle ends and fold or hang immediately.
Overloading	Separate large loads into smaller ones.	
<i>Clothes shrink</i>	Some fabrics will naturally shrink when washed. Others can be safely washed, but will shrink in the dryer	To avoid shrinkage, follow garment care labels exactly.
		Some items may be pressed back into shape after drying
		If you are concerned about shrinkage in a particular item, do not machine wash or tumble dry it.

This Appliance Warranty.

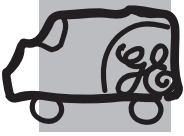

All warranty service provided by our Factory Service Centers, or an authorized Customer Care® technician. To schedule service, on-line, visit us at **GEAppliances.com**, or call **800.GE.CARES** (800.432.2737). In Canada, visit **GEAppliances.ca** or call **800.561.3344**. Please have serial number and model number available when calling for service.

Staple your receipt here.
Proof of the original purchase date is needed to obtain service under the warranty.

For The Period Of: We Will Replace:

One Year

From the date of the original purchase

Any part of the washer which fails due to a defect in materials or workmanship. During this **limited one-year warranty**, we will also provide, **free of charge**, all labor and related service to replace the defective part.

What Is Not Covered for Customers in the United States:

- Service trips to your home to teach you how to use the product.
- Improper installation, delivery or maintenance.
- Failure of the product if it is abused, misused, or used for other than the intended purpose or used commercially.
- Replacement of house fuses or resetting of circuit breakers.
- Products which are not defective or broken, or which are working as described in the Owner's Manual.
- Damage to the product caused by accident, fire, floods or acts of God.
- Incidental or consequential damage caused by possible defects with this appliance.
- Defects or damage due to operation in freezing temperatures.
- Damage caused after delivery.
- Product not accessible to provide required service.

EXCLUSION OF IMPLIED WARRANTIES—Your sole and exclusive remedy is product repair as provided in this Limited Warranty. Any implied warranties, including the implied warranties of merchantability or fitness for a particular purpose, are limited to one year or the shortest period allowed by law.

This warranty is extended to the original purchaser and any succeeding owner for products purchased for home use within the USA. If the product is located in an area where service by a GE Authorized Servicer is not available, you may be responsible for a trip charge or you may be required to bring the product to an Authorized GE Service location. In Alaska, the warranty excludes the cost of shipping or service calls to your home.

Some states do not allow the exclusion or limitation of incidental or consequential damages. This warranty gives you specific legal rights, and you may also have other rights which vary from state to state. To know what your legal rights are, consult your local or state consumer affairs office or your state's Attorney General.

Warrantor: General Electric Company, Louisville, KY 40225

What Is Not Covered for Customers in Canada:

- Service trips to your home to teach you how to use the product.
- Improper installation, delivery or maintenance.
If you have an installation problem, contact your dealer or installer. You are responsible for providing adequate electrical, exhausting and other connecting facilities.
- Failure of the product if it is abused, misused, or used for other than the intended purpose or used commercially.
- Replacement of house fuses or resetting of circuit breakers.
- Damage to the product caused by accident, fire, floods or acts of God.
- Damage caused after delivery.

EXCLUSION OF IMPLIED WARRANTIES—Your sole and exclusive remedy is product repair as provided in this Limited Warranty. Any implied warranties, including the implied warranties of merchantability or fitness for a particular purpose, are limited to one year or the shortest period allowed by law.

This warranty is extended to the original purchaser and any succeeding owner for products purchased in Canada for home use within Canada. In home warranty service will be provided in areas where it is available and deemed reasonable by Mabe to provide.

WARRANTOR IS NOT RESPONSIBLE FOR CONSEQUENTIAL DAMAGES.

Warrantor: MC COMMERCIAL, Burlington, L7R 5B6

Consumer Support.



GE Appliances Website

In the U.S. **GEAppliances.com**

Have a question or need assistance with your appliance? Try the GE Appliances Website 24 hours a day, any day of the year! For greater convenience and faster service, you can now download Owner's Manuals, order parts or even schedule service on-line. **In Canada: www.GEAppliances.ca.**

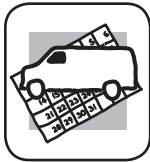

Schedule Service

In the U.S. **GEAppliances.com**

Expert GE repair service is only one step away from your door. Get on-line and schedule your service at your convenience 24 hours any day of the year! Or call 800.GE.CARES (800.432.2737) during normal business hours. **In Canada, call 800.561.3344.**



Real Life Design Studio

In the U.S. **GEAppliances.com**

GE supports the Universal Design concept—products, services and environments that can be used by people of all ages, sizes and capabilities. We recognize the need to design for a wide range of physical and mental abilities and impairments. For details of GE's Universal Design applications, including kitchen design ideas for people with disabilities, check out our Website today. For the hearing impaired, please call 800.561.3344.

In Canada: contact: Director, Consumer Relations, Mabe Canada Inc.
Suite 310, 1 Factory Lane
Moncton, N.B. E1C 9MC



Extended Warranties

In the U.S. **GEAppliances.com**

Purchase a GE extended warranty and learn about special discounts that are available while your warranty is still in effect. You can purchase it on-line anytime, or call 800.626.2224 during normal business hours. GE Consumer Home Services will still be there after your warranty expires. **In Canada, please visit our Website or contact your local extended warranty provider.**

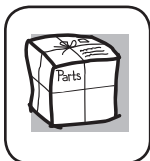

Parts and Accessories

In the U.S. **GEAppliances.com**

Individuals qualified to service their own appliances can have parts or accessories sent directly to their homes (VISA, MasterCard and Discover cards are accepted). Order on-line today, 24 hours every day or by phone at 800.626.2002 during normal business hours.

Instructions contained in this manual cover procedures to be performed by any user. Other servicing generally should be referred to qualified service personnel. Caution must be exercised, since improper servicing may cause unsafe operation.

Customers in **Canada** should consult the yellow pages for the nearest GE parts distributor or call **800.661.1616**.



Contact Us

In the U.S. **GEAppliances.com**

If you are not satisfied with the service you receive from GE, contact us on our Website with all the details including your phone number, or write to:

General Manager, Customer Relations
GE Appliances, Appliance Park
Louisville, KY 40225

In Canada: GEAppliances.ca, or write: Director, Consumer Relations, Mabe Canada Inc.
Suite 310, 1 Factory Lane
Moncton, N.B. E1C 9MC



Register Your Appliance

In the U.S. **GEAppliances.com**

Register your new appliance on-line—at your convenience! Timely product registration will allow for enhanced communication and prompt service under the terms of your warranty, should the need arise. You may also mail in the pre-printed registration card included in the packing material. **In Canada: www.GEAppliances.ca.**