



Microwave Oven

Safety Instructions2-6

Operating Instructions

Convenience Features13-15

Microwave Terms18

Oven Features7, 8

Other Features16, 17

Power Levels9

Time Features10-12

Care and Cleaning19

Troubleshooting Tips20

Things That Are Normal20

Consumer Support

Consumer Support . . .Back Cover

Product Registration21, 22

Warranty23

Owner's Manual

JE1140

Write the model and serial numbers here:

Model # _____

Serial # _____

You can find them on a label inside the oven.



IMPORTANT SAFETY INSTRUCTIONS. READ ALL INSTRUCTIONS BEFORE USING.

⚠ **WARNING!**

For your safety, the information in this manual must be followed to minimize the risk of fire or explosion, electric shock, or to prevent property damage, personal injury, or loss of life.

PRECAUTIONS TO AVOID POSSIBLE EXPOSURE TO EXCESSIVE MICROWAVE ENERGY

- (a) **Do Not Attempt** to operate this oven with the door open since open-door operation can result in harmful exposure to microwave energy. It is important not to defeat or tamper with the safety interlocks.
- (b) **Do Not Place** any object between the oven front face and the door or allow soil or cleaner residue to accumulate on sealing surfaces.
- (c) **Do Not Operate** the oven if it is damaged. It is particularly important that the oven door close properly and that there is no damage to the:
 - (1) door (bent),
 - (2) hinges and latches (broken or loosened),
 - (3) door seals and sealing surfaces.
- (d) **The Oven Should Not** be adjusted or repaired by anyone except properly qualified service personnel.

IMPORTANT SAFETY INSTRUCTIONS.

This microwave oven is not approved or tested for marine use.

Use this appliance only for its intended purpose as described in this Owner's Manual.

- Read and follow the specific precautions in the *Precautions to Avoid Possible Exposure to Excessive Microwave Energy* section above.
- This appliance must be grounded. Connect only to a properly grounded outlet. See the *Grounding Instructions* section on page 5.
- Install or locate this appliance only in accordance with the provided installation instructions.
- Be certain to place the front surface of the door 7.6 cm (three inches) or more back from the countertop edge to avoid accidental tipping of the appliance in normal usage.
- Do not mount this appliance over a sink.
- Do not mount the microwave oven over or near any portion of a heating or cooking appliance.
- Do not store anything directly on top of the microwave oven surface when the microwave oven is in operation.
- Do not operate this appliance if it has a damaged power cord or plug, if it is not working properly, or if it has been damaged or dropped. If the power cord is damaged, it must be replaced by Mabe Service or an authorized service agent using a power cord available from Mabe.
- Do not cover or block any openings on the appliance.
- Use this appliance only for its intended use as described in this manual. Do not use corrosive chemicals or vapors in this appliance. This microwave oven is specifically designed to heat, dry or cook food, and is not intended for laboratory or industrial use.
- Do not store this appliance outdoors. Do not use this product near water—for example, in a wet basement, near a swimming pool, or near a sink.
- Keep power cord away from heated surfaces.
- Do not immerse power cord or plug in water.
- Do not let power cord hang over edge of table or counter.
- To reduce the risk of fire in the oven cavity:
 - Do not overcook food. Carefully attend appliance if paper, plastic or other combustible materials are placed inside the oven while cooking.
 - Remove wire twist-ties and metal handles from paper or plastic containers before placing them in the oven.
 - Do not use the oven for storage purposes. Do not leave paper products, cooking utensils or food in the oven when not in use.
 - If materials inside the oven should ignite, keep the oven door closed, turn the oven off and disconnect the power cord, or shut off power at the fuse or circuit breaker panel. If the door is opened, the fire may spread.
- See door surface cleaning instructions in the *Care and cleaning of the microwave oven* section of this manual.
- This appliance should be serviced only by qualified service personnel. Contact nearest authorized service facility for examination, repair or adjustment.
- As with any appliance, close supervision is necessary when used by children.

SAVE THESE INSTRUCTIONS

⚠ WARNING!



ARCING

If you see arcing, press the **CANCEL/STOP** pad and correct the problem.

Arcing is the microwave term for sparks in the oven. Arcing is caused by:

- Metal or foil touching the side of the oven.
- Metal, such as twist-ties, poultry pins or gold-rimmed dishes, in the microwave.
- Foil not molded to food (upturned edges act like antennas).
- Recycled paper towels containing small metal pieces being used in the microwave.



FOODS

- Do not pop popcorn in your microwave oven unless in a special microwave popcorn accessory or unless you use popcorn labeled for use in microwave ovens.
- Some products such as whole eggs and sealed containers—for example, closed jars—will explode and should not be heated in this microwave oven. Such use of the microwave oven could result in injury.
- Do not boil eggs in a microwave oven. Pressure will build up inside egg yolk and will cause it to burst, possibly resulting in injury.
- Operating the microwave with no food inside for more than a minute or two may cause damage to the oven and could start a fire. It increases the heat around the magnetron and can shorten the life of the oven.
- Foods with unbroken outer “skin” such as potatoes, hot dogs, sausages, tomatoes, apples, chicken livers and other giblets and egg yolks should be pierced to allow steam to escape during cooking.
- **SUPERHEATED WATER**
Microwaved water and other liquids do not always bubble when they reach the boiling point. They can actually get superheated and not bubble at all.
Superheated liquid will bubble up out of the cup when it is moved or when something like a spoon or tea bag is put into it.
To prevent this from happening and causing injury, do not heat any liquid for more than 2 minutes per cup. After heating, let the cup stand in the microwave for 30 seconds before moving it or putting anything into it.
- Avoid heating baby food in glass jars, even with the lid off. Make sure all infant food is thoroughly cooked. Stir food to distribute the heat evenly. Be careful to prevent scalding when warming formula. The container may feel cooler than the formula really is. Always test the formula before feeding the baby.
- Don’t defrost frozen beverages in narrow-necked bottles (especially carbonated beverages). Even if the container is opened, pressure can build up. This can cause the container to burst, possibly resulting in injury.
- Spontaneous boiling—Under certain special circumstances, liquids may start to boil during or shortly after removal from the microwave oven. To prevent burns from splashing liquid, we recommend the following: before removing the container from the oven, allow the container to stand in the oven for 30 to 40 seconds after the oven has shut off. Do not boil liquids in narrow-necked containers such as soft drink bottles, wine flasks, and especially narrow-necked coffee cups. Even if the container is opened, excessive steam can build up and cause it to burst or overflow.
- Hot foods and steam can cause burns. Be careful when opening any containers of hot food, including popcorn bags, cooking pouches and boxes. To prevent possible injury, direct steam away from hands and face.
- Do not overcook potatoes. They could dehydrate and catch fire, causing damage to your oven.
- Cook meat and poultry thoroughly—meat to at least an INTERNAL temperature of 70° C (160° F) and poultry to at least an INTERNAL temperature of 80° C (180° F). Cooking to these temperatures usually protects against foodborne illness.

IMPORTANT SAFETY INFORMATION. READ ALL INSTRUCTIONS BEFORE USING.

⚠ **WARNING!**



MICROWAVE-SAFE COOKWARE

Make sure all cookware used in your microwave oven is suitable for microwaving. Most glass casseroles, cooking dishes, measuring cups, custard cups, pottery or china dinnerware which does not have metallic trim or glaze with a metallic sheen can be used. Some cookware is labeled “suitable for microwaving.”

- If you are not sure if a dish is microwave-safe, use this test: Place in the oven both the dish you are testing and a glass measuring cup filled with 250 mL (1 cup) of water—set the measuring cup either in or next to the dish. Microwave 30–45 seconds at high. If the dish heats, it should not be used for microwaving.

If the dish remains cool and only the water in the cup heats, then the dish is microwave-safe.

- If you use a meat thermometer while cooking, make sure it is safe for use in microwave ovens.
- Do not use recycled paper products. Recycled paper towels, napkins and waxed paper can contain metal flecks which may cause arcing or ignite. Paper products containing nylon or nylon filaments should be avoided, as they may also ignite.
- Some styrofoam trays (like those that meat is packaged on) have a thin strip of metal embedded in the bottom. When microwaved, the metal can burn the floor of the oven or ignite a paper towel.
- Do not use the microwave to dry newspapers.
- Not all plastic wrap is suitable for use in microwave ovens. Check the package for proper use.
- Paper towels, waxed paper and plastic wrap can be used to cover dishes in order to retain moisture and prevent spattering. Be sure to vent plastic wrap so steam can escape.

- Cookware may become hot because of heat transferred from the heated food. Pot holders may be needed to handle the cookware.
- “Boilable” cooking pouches and tightly closed plastic bags should be slit, pierced or vented as directed by package. If they are not, plastic could burst during or immediately after cooking, possibly resulting in injury. Also, plastic storage containers should be at least partially uncovered because they form a tight seal. When cooking with containers tightly covered with plastic wrap, remove covering carefully and direct steam away from hands and face.
- Use foil only as directed in this guide. TV dinners may be microwaved in foil trays less than 1.9 cm (3/4”) high; remove the top foil cover and return the tray to the box. When using foil in the microwave oven, keep the foil at least 2.5 cm (1 inch) away from the sides of the oven.
- Plastic cookware—Plastic cookware designed for microwave cooking is very useful, but should be used carefully. Even microwave-safe plastic may not be as tolerant of overcooking conditions as are glass or ceramic materials and may soften or char if subjected to short periods of overcooking. In longer exposures to overcooking, the food and cookware could ignite.

Follow these guidelines:

- 1 Use microwave-safe plastics only and use them in strict compliance with the cookware manufacturer’s recommendations.
- 2 Do not microwave empty containers.
- 3 Do not permit children to use plastic cookware without complete supervision.



GROUNDING INSTRUCTIONS

⚠ WARNING—*Improper use of the grounding plug can result in a risk of electric shock.*

This appliance must be grounded. In the event of an electrical short circuit, grounding reduces the risk of electric shock by providing an escape wire for the electric current.

This appliance is equipped with a power cord having a grounding wire with a grounding plug. The plug must be plugged into an outlet that is properly installed and grounded.

Consult a qualified electrician or service technician if the grounding instructions are not completely understood, or if doubt exists as to whether the appliance is properly grounded.

If the outlet is a standard 2-prong wall outlet, it is your personal responsibility and obligation to have it replaced with a properly grounded 3-prong wall outlet.

Do not under any circumstances cut or remove the third (ground) prong from the power cord.

We do not recommend using an extension cord with this appliance. If the power cord is too short, have a qualified electrician or service technician install an outlet near the appliance. (See *EXTENSION CORDS* section.)

For best operation, plug this appliance into its own electrical outlet to prevent flickering of lights, blowing of fuse or tripping of circuit breaker.



ADAPTER PLUGS

Adapter Plugs are not permitted in Canada.

IMPORTANT SAFETY INFORMATION. READ ALL INSTRUCTIONS BEFORE USING.

⚠ WARNING!

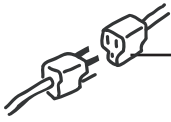

EXTENSION CORDS

A short power supply cord is provided to reduce the risks resulting from becoming entangled in or tripping over a longer cord.

Extension cords may be used if you are careful in using them.

If an extension cord is used—

- 1** The marked electrical rating of the extension cord should be at least as great as the electrical rating of the appliance;
- 2** The extension cord must be a grounding-type 3-wire cord and it must be plugged into a 3-slot outlet;
- 3** The extension cord should be arranged so that it will not drape over the countertop or tabletop where it can be pulled on by children or tripped over unintentionally.

If you use an extension cord, the interior light may flicker and the blower sound may vary when the microwave oven is on. Cooking times may be longer, too.



READ AND FOLLOW THIS SAFETY INFORMATION CAREFULLY.

SAVE THESE INSTRUCTIONS

About the features of your microwave oven.

www.GEAppliances.ca

Throughout this manual, features and appearance may vary from your model.

1100 Watts

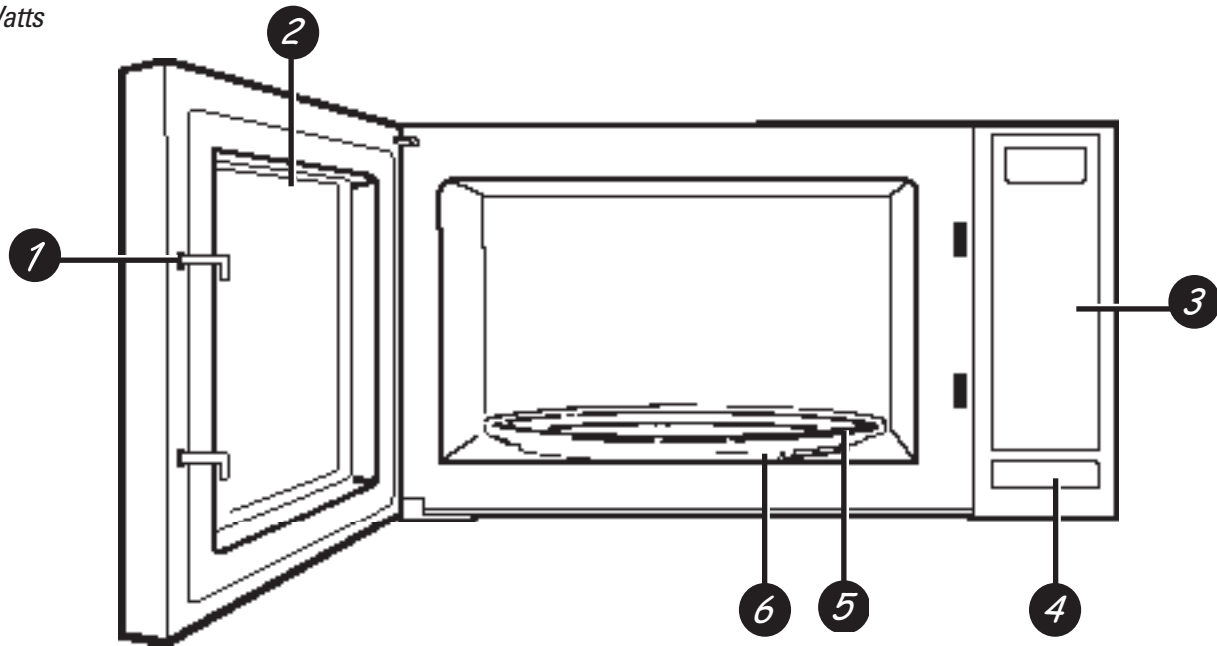

Features of the Oven

- 1 Door Latches.**
- 2 Window with Metal Shield.** Screen allows cooking to be viewed while keeping microwaves confined in the oven.
- 3 Touch Control Panel Display.**
- 4 Door Latch Release.** Press latch release to open door.

- 5 Removable Turntable.** Turntable and support **must** be in place when using the oven. The turntable may be removed for cleaning.
- 6 Removable Turntable Support.** The turntable support must be in place when using the oven.

NOTE: Rating plate, oven vent(s) and oven light are located on the inside walls of the microwave oven.

About the features of your microwave oven.

You can microwave by time or with the convenience features.

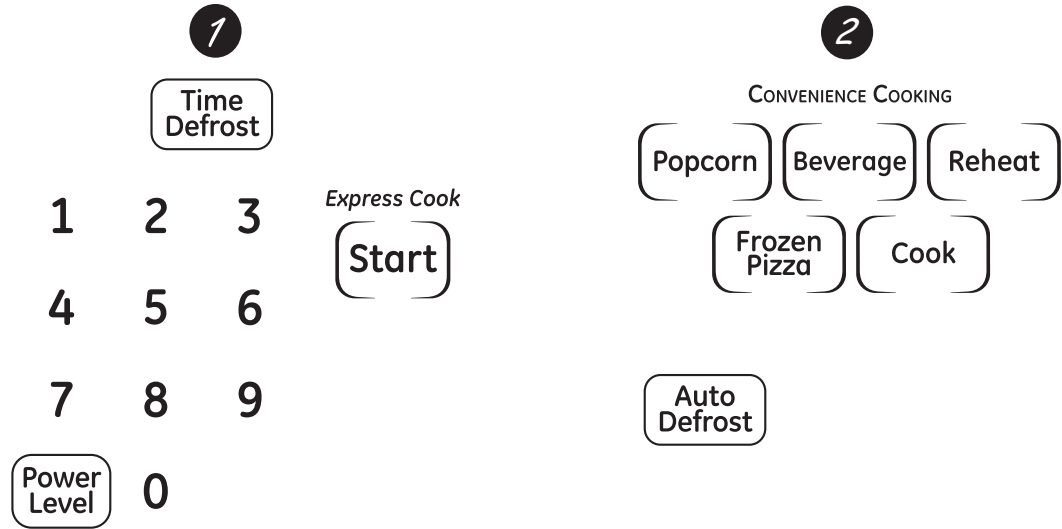

Cooking Controls

1 Time Features

Press	Enter
Time Cook Press number pads	Amount of cooking time
TIME DEFROST	Amount of defrosting time
POWER LEVEL	Power level 0 to HI
EXPRESS COOK	Starts immediately!

2 Convenience Features

Press	Enter	Option
POPCORN Press once, twice or three times	Starts immediately!	100 g, 85 g, or 50 g (3.5 oz., 3 oz. or 1.75 oz.)
BEVERAGE Press once, twice or three times	Starts immediately!	250 mL, 500 mL or 750 mL (1 cup, 2 cups or 3 cups)
REHEAT Press once or twice	Starts immediately!	350 g or 500 g (12 oz. or 15 oz.)
COOK Press one to five times	Food type 1–5	
AUTO DEFROST Press one to four times	Food weight	0.5 kg, 0.75 kg, 0.9 kg or 1.1 kg (1 lb., 1.5 lbs., 2 lbs. or 2.5 lbs.)
FROZEN PIZZA Press once or twice	Starts immediately!	200 g or 400 g (7 oz. or 14 oz.)

About changing the power level.

Power Level

1 2 3
4 5 6
7 8 9
0

Express Cook

Start

The power level may be entered or changed before entering the time for **Time Cook**.

- 1 Press **POWER LEVEL** repeatedly to select power level **0** to **HI**.
- 2 Enter cooking time.
- 3 Press **START**.

Variable power levels add flexibility to microwave cooking. The power levels on the microwave oven can be compared to the surface units on a range. Each power level gives you microwave energy a certain percent of the time. **Power level 70** is microwave energy 70% of the time. **Power level 30** is energy 30% of the time. Most cooking will be done on **HI** which gives you 100% power. **HI power level** will cook faster but food may need more frequent stirring, rotating or turning over. A lower setting will cook more evenly and need less stirring or rotating of the food. Some foods may have better flavor, texture or appearance if one of the lower settings is used. Use a lower power level when cooking foods that have a tendency to boil over, such as scalloped potatoes.

Rest periods (when the microwave energy cycles off) give time for the food to “equalize” or transfer heat to the inside of the food. An example of this is shown with **power level 30**—the defrost cycle. If microwave energy did not cycle off, the outside of the food would cook before the inside was defrosted.

Here are some examples of uses for various power levels:

HI: Fish, bacon, vegetables, boiling liquids.

Med-High 70: Gentle cooking of meat and poultry; baking casseroles and reheating.

Medium 50: Slow cooking and tenderizing for stews and less tender cuts of meat.

Low 20 or 30: Defrosting; simmering; delicate sauces.

Warm 10: Keeping food warm; softening butter.

About the time features.

1 2 3
4 5 6
7 8 9
0

Express Cook

Start

Time Cook

Allows you to microwave for any time up to 99 minutes and 99 seconds.

HI power level is automatically set, but you may change it for more flexibility.

1 Change power level if you don't want full power. (Press **POWER LEVEL** repeatedly to select a desired power level.)

2 Enter cooking time.

3 Press **START**.

You may open the door during **Time Cook** to check the food. Close the door and press **START** to resume cooking.

Defrosting and Cooking

You can program the oven to automatically begin **Time Cook** after defrosting.

1 Press **AUTO DEFROST** and select food weight, or press **TIME DEFROST** and enter defrosting time.

2 Press **POWER LEVEL**. Change power level if you don't want full power. (Press **POWER LEVEL** repeatedly to select a desired power level.)

3 Enter the amount of cooking time.

4 Press **START**.

The oven will begin defrosting. After defrosting is complete, **Time Cook** will count down.

Express Cook

Start

Express Cook

This is a quick way to set cooking time for 30 seconds. It will add 30 seconds to the time each time the pad is pressed. The oven will start immediately.

Cooking Guide for Time Cook

NOTE: Use **HI power level** unless otherwise noted.

Vegetable	Amount	Time	Comments
Asparagus (fresh spears)	454 g (1 lb.)	5 to 8 min., Med-High (7)	In 1.5 l (1½-qt.) casserole, place 60 ml (¼ cup) water.
(frozen spears)	283 g (10-oz.) package	4 to 7 min.	In 1 l (1-qt.) casserole, place 30 ml (2 tablespoons) water.
Beans (fresh green)	454 g (1 lb.) cut in half	10 to 15 min.	In 1.5 l (1½-qt.) casserole, place 120 ml (½ cup) water.
(frozen green)	283 g (10-oz.) package	4 to 8 min.	In 1 l (1-qt.) casserole, place 30 ml (2 tablespoons) water.
(frozen lima)	283 g (10-oz.) package	4 to 8 min.	In 1 l (1-qt.) casserole, place 60 ml (¼ cup) water.
Beets (fresh, whole)	1 bunch	16 to 22 min.	In 2 l (2-qt.) casserole, place 120 ml (½ cup) water.
Broccoli (fresh cut)	1 bunch 570 à 680 g (1¼ to 1½ lbs.)	5 to 9 min.	In 2 l (2-qt.) casserole, place 120 ml (½ cup) water.
(fresh spears)	1 bunch 570 à 680 g (1¼ to 1½ lbs.)	7 to 11 min.	In 2 l (2-qt.) casserole, place 60 ml (¼ cup) water.
(frozen, chopped)	283 g (10-oz.) package	4 to 7 min.	In 1 l (1-qt.) casserole, place 30 ml (2 tablespoons) water.
(frozen spears)	283 g (10-oz.) package	4 to 7 min.	In 1 l (1-qt.) casserole, place 45 ml (3 tablespoons) water.
Cabbage (fresh)	1 medium head – about 900 g (2 lbs.)	6 to 10 min.	In 1.5 or 2 l (1½ or 2-qt.) casserole, place 60 ml (¼ cup) water.
(wedges)		5 to 9 min.	In 2 or 3 l (2- or 3-qt.) casserole, place 60 ml (¼ cup) water.
Carrots (fresh, sliced)	454 g (1 lb.)	4 to 8 min.	In 1.5 l (1½-qt.) casserole, place 60 ml (¼ cup) water.
(frozen)	283 g (10-oz.) package	3 to 7 min.	In 1 l (1-qt.) casserole, place 30 ml (2 tablespoons) water.
Cauliflower (flowerets)	1 medium head	7 to 10 min.	In 2 l (2-qt.) casserole, place 120 ml (½ cup) water.
(fresh, whole)	1 medium head	7 to 15 min.	In 2 l (2-qt.) casserole, place 120 ml (½ cup) water.
(frozen)	283 g (10-oz.) package	3 to 7 min.	In 1 l (1-qt.) casserole, place 30 ml (2 tablespoons) water.
Corn (frozen kernel)	283 g (10-oz.) package	2 to 6 min.	In 1 l (1-qt.) casserole, place 30 ml (2 tablespoons) water.
Corn on the cob (fresh)	1 to 5 ears	1¼ to 4 min. per ear	In 2 l (2-qt.) glass baking dish, place corn. If corn is in husk, use no water; if corn has been husked, add 60 ml (¼ cup) water. Rearrange after half of time.
(frozen)	1 ear 2 to 6 ears	3 to 6 min. 2 to 3 min. per ear	Place in 2 l (2-qt.) oblong glass baking dish. Cover with vented plastic wrap. Rearrange after half of time.
Mixed vegetables (frozen)	283 g (10-oz.) package	2 to 6 min.	In 1 l (1-qt.) casserole, place 45 ml (3 tablespoons) water.
Peas (fresh, shelled)	900 g (2 lbs.) unshelled	7 to 10 min.	In 1 l (1-qt.) casserole, place 60 ml (¼ cup) water.
(frozen)	283 g (10-oz.) package	2 to 6 min.	In 1 l (1-qt.) casserole, place 30 ml (2 tablespoons) water.
Potatoes (fresh, cubed, white)	4 potatoes 170 to 225 g (6 to 8 oz.) each	9 to 12 min.	Peel and cut into 1-inch cubes. Place in 2 l (2-qt.) casserole with 120 ml (½ cup) water. Stir after half of time.
(fresh, whole, sweet or white)	1 – 170 to 225 g (6 to 8 oz.)	2 to 4 min.	Pierce with cooking fork. Place in the oven, 2.5 cm (1") apart, in circular arrangement. Let stand 5 minutes.
Spinach (fresh)	283 to 454 g (10 to 16 oz.)	3 to 6 min.	In 2 l (2-qt.) casserole, place washed spinach.
(frozen, chopped and leaf)	283 g (10-oz.) package	3 to 6 min.	In 1 l (1-qt.) casserole, place 45 ml (3 tablespoons) water.
Squash (fresh, summer, and yellow)	454 g (1 lb.) sliced	3 to 5 min.	In 1.5 l (1½-qt.) casserole, place 60 ml (¼ cup) water.
(winter, acorn or butternut)	1 to 2 squash – about 450 g (1 lb.) each	5 to 9 min.	Cut in half and remove fibrous membranes. In 2 l (2-qt.) glass baking dish, place squash cut-side-down. Turn cut-side-up after 4 minutes.

About the time features.



Time Defrost

Allows you to defrost for a selected length of time. See the Defrosting Guide for suggested times. (**Auto Defrost** explained in the *About the convenience features* section.)

- 1** Press **TIME DEFROST**.
- 2** Enter defrosting time.
- 3** Press **START**.
- 4** Turn the food over after half the time.
- 5** Press **START**.

At one half of selected defrosting time, turn food over and break apart or rearrange pieces for more even defrosting. Shield any warm areas with small pieces of foil. The oven will continue to defrost if you don't open the door and turn the food.

A dull thumping noise may be heard during defrosting. This is normal when oven is not operating at **HI** power.

Defrosting Tips

- Foods frozen in paper or plastic can be defrosted in the package. Closed packages should be slit, pierced or vented **AFTER** food has partially defrosted. Plastic storage containers should be partially uncovered.
- Family-size, prepackaged frozen dinners can be defrosted and microwaved. If the food is in a foil container, transfer it to a microwave-safe dish.
- Foods that spoil easily should not be allowed to sit out for more than one hour after defrosting. Room temperature promotes the growth of harmful bacteria.
- For more even defrosting of larger foods, such as roasts, use **Auto Defrost**. Be sure large meats are completely defrosted before cooking.
- When defrosted, food should be cool but softened in all areas. If still slightly icy, return to the microwave very briefly, or let it stand a few minutes.

Defrosting Guide

Food	Time	Comments
Breads, Cakes <i>Bread, buns or rolls (1 piece)</i> <i>Sweet rolls approx. 340 g (12 oz.)</i>	¼ min. 2 to 4 min.	Rearrange after half the time.
Fish and Seafood <i>Fillets, frozen 454 g (1 lb.)</i> <i>Shellfish, small pieces 454 g (1 lb.)</i>	6 to 9 min. 3 to 7 min.	Place block in casserole. Turn over and break up after half the time.
Fruit <i>Plastic pouch—1 or 2</i> <i>283 g (10-oz. package)</i>	1 to 5 min.	
Meat <i>Bacon 454 g (1 lb.)</i> <i>Franks 454 g (1 lb.)</i> <i>Ground meat 454 g (1 lb.)</i> <i>Roast: beef, lamb, veal, pork</i>	2 to 5 min. 2 to 5 min. 4 to 6 min. 9 to 13 min. per 454 g/lb.	Place unopened package in oven. Let stand 5 minutes after defrosting. Place unopened package in oven. Microwave just until franks can be separated. Let stand 5 minutes, if necessary, to complete defrosting. Turn meat over after first half of time. Use power level 1 .
Steaks, chops and cutlets	4 to 8 min. per 454 g/lb.	Place unwrapped meat in cooking dish. Turn over after first half of time and shield warm areas with foil. After second half of time, separate pieces with table knife. Let stand to complete defrosting.
Poultry <i>Chicken, broiler-fryer, cut up</i> <i>1.1 to 1.4 kg (2½ to 3 lbs.)</i> <i>Chicken, whole</i> <i>1.1 to 1.4 kg (2½ to 3 lbs.)</i> <i>Cornish hen</i> <i>Turkey breast</i> <i>1.8 to 2.7 kg (4 to 6 lbs.)</i>	14 to 20 min. 20 to 25 min. 7 to 13 min. per 454 g/lb. 3 to 8 min. per 454 g/lb.	Place wrapped chicken in dish. Unwrap and turn over after first half of time. After second half of time, separate pieces and place in cooking dish. Microwave 2 to 4 minutes more, if necessary. Let stand a few minutes to finish defrosting. Place wrapped chicken in dish. After half the time, unwrap and turn chicken over. Shield warm areas with foil. To complete defrosting, run cold water in the cavity until giblets can be removed. Place unwrapped hen in the oven breast-side-up. Turn over after first half of time. Run cool water in the cavity until giblets can be removed. Place unwrapped breast in microwave-safe dish breast-side-down. After first half of time, turn breast-side-up and shield warm areas with foil. Defrost for second half of time. Let stand 1 to 2 hours in refrigerator to complete defrosting.

Popcorn

Use only with prepackaged microwave popcorn weighing 50 to 100 g (1.75 to 3.5 ounces).

Popcorn

To use the **Popcorn** feature:

- 1 Follow package instructions, using **Time Cook** if the package is less than 50 g (1.75 ounces) or larger than 100 g (3.5 ounces). Place the package of popcorn in the center of the microwave.
- 2 Press **POPCORN** once for a 100 g (3.5 ounce) package of popcorn, twice for a 85 g (3.0 ounce) package or three times for a 50 g (1.75 ounce) package. The oven starts immediately.

Reheat

Reheat

The **Reheat** feature reheats 340 or 425 g (12 or 15 ounce) servings of many previously cooked foods.

Press **REHEAT** once to select 340 g (12 ounces) or twice to select 425 g (15 ounces). The oven starts immediately.

Beverage

Beverage

To use the **Beverage** feature:

Press **BEVERAGE** once for 250 mL (1 cup), twice for 500 mL (2 cups) or three times for 750 mL (3 cups).

Drinks heated with the Beverage feature may be very hot. Remove the container with care.

Frozen Pizza

Frozen Pizza

To use the **Frozen Pizza** feature:

- 1 Follow package instructions, using **Time Cook** if the pizza is less than 200 g (7 ounces) or larger than 400 g (14 ounces).
- 2 Press **FROZEN PIZZA** once for a 200 g (7 ounce) pizza or twice for a 400 g (14 ounce) pizza. The oven starts immediately.

About the convenience features.

Cook

Express Cook

Start

Cook

The **Cook** feature automatically sets the cooking times and power levels for a variety of foods.

- 1** Press **COOK** repeatedly to select food type 1–5.
- 2** Press **START**.

Cook Guide

Food Type	Weight	Comments
1 Canned Vegetables	1 can 414 to 475 mL (14 to 16 oz.)	Use microwave-safe casserole or bowl. Cover with lid or vented plastic wrap.
2 Soup	355 mL (12 oz.)	Cover with lid or vented plastic wrap.
3 Potatoes	4 potatoes 225 to 283 g (8 to 10 oz.) each	Pierce skin with fork. Place potatoes on the turntable.
4 Fresh Vegetables	450 g (16 oz.)	Use microwave-safe casserole or bowl. Add 30 mL (2 tablespoons) water for each serving. Cover with lid or vented plastic wrap.
5 Frozen Vegetables	450 g (16 oz.)	Use microwave-safe casserole or bowl. Follow package instructions for adding water. Cover with lid or vented plastic wrap.

Auto Defrost

Express Cook

Start

Auto Defrost

Use **Auto Defrost** for meat, poultry and fish weighing up to 1.1 kg (2.5 pounds). Use **Time Defrost** for most other frozen foods.

Auto Defrost automatically sets the defrosting times and power levels to give even defrosting results for meats, poultry and fish.

1 Press **AUTO DEFROST** repeatedly to select 450 g to 1.1 kg (1 to 2.5 pounds).

2 Press **START**.

(**Time Defrost** is explained in the *About the time features* section.)

- Remove meat from package and place on microwave-safe dish.
- When the oven signals, turn the food over. Remove defrosted meat or shield warm areas with small pieces of foil.
- After defrosting, most meats need to stand 5 minutes to complete defrosting. Large roasts should stand for about 30 minutes.

About the other features.



1 2 3
4 5 6
7 8 9
0

Clock

Press to enter the time of day.

- 1** Press **CLOCK** once to select 12 hour time or twice to select 24 hour time.
- 2** Enter time of day.
- 3** Press **CLOCK**.



Cancel/Stop

In addition to cancelling selections, **CANCEL/STOP** allows you to stop cooking without opening the door or clearing the display. Press **START** to restart the oven.



Child Lock-Out

You may lock the control panel to prevent the microwave from being accidentally started or used by children.

To lock or unlock the controls, press and hold **CANCEL/STOP** for about three seconds. When the control panel is locked, the lock indicator will be lit.

Timer

Auto
DefrostTime
DefrostPower
Level

1 2 3

4 5 6

7 8 9

0

Express Cook

Start

Timer**This pad performs three functions:**

- It operates as a minute timer.
- It can be set to delay cooking.
- It can be used as a hold setting after defrosting.

How to Use as a Minute Timer

The **Timer** operates without microwave energy.

- 1** Press **TIMER**.
- 2** Enter the amount of time you want to count down.
- 3** Press **START**. When the time is up, the timer will signal.

How to Use to Delay the Start of Cooking

You can set the microwave to delay the start of cooking up to 99 minutes and 99 seconds.

- 1** Press **TIMER**.
- 2** Enter the amount of time to delay the start of cooking.
- 3** Press **POWER LEVEL**. Change power level if you don't want full power. (Press **POWER LEVEL** repeatedly to select a desired power level.)
- 4** Enter the amount of cooking time.
- 5** Press **START**.

The timer will begin counting down to zero and cooking will then begin.

How to Use to Set a Holding Time

- 1** Press **AUTO DEFROST** and select food weight, or press **TIME DEFROST** and enter defrosting time.
- 2** Press **TIMER**.
- 3** Enter the amount of time you want the oven to hold.
- 4** Press **START**.

The oven will begin defrosting. After defrosting is complete, the holding time will count down.

Microwave terms.

Term	Definition
Arcing	<p>Arcing is the microwave term for sparks in the oven. Arcing is caused by:</p> <ul style="list-style-type: none"> ■ metal or foil touching the side of the oven. ■ foil that is not molded to food (upturned edges act like antennas). ■ metal such as twist-ties, poultry pins, gold-rimmed dishes. ■ recycled paper towels containing small metal pieces.
Covering	Covers hold in moisture, allow for more even heating and reduce cooking time. Venting plastic wrap or covering with wax paper allows excess steam to escape.
Shielding	In a regular oven, you shield chicken breasts or baked foods to prevent over-browning. When microwaving, you use small strips of foil to shield thin parts, such as the tips of wings and legs on poultry, which would cook before larger parts.
Standing Time	When you cook with regular ovens, foods such as roasts or cakes are allowed to stand to finish cooking or to set. Standing time is especially important in microwave cooking. Note that a microwaved cake is not placed on a cooling rack.
Venting	After covering a dish with plastic wrap, you vent the plastic wrap by turning back one corner so excess steam can escape.



Helpful Hints

An occasional thorough wiping with a solution of baking soda and water keeps the inside fresh.

Unplug the cord before cleaning any part of this oven.

How to Clean the Inside

Walls, Floor, Inside Window, Metal and Plastic Parts on the Door

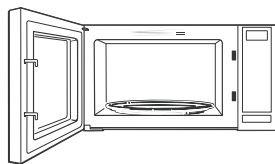

Some spatters can be removed with a paper towel; others may require a damp cloth. Remove greasy spatters with a sudsy cloth, then rinse with a damp cloth. Do not use abrasive cleaners or sharp utensils on oven walls.

To clean the surface of the door and the surface of the oven that come together upon closing, use only mild, nonabrasive soaps or detergents using a sponge or soft cloth. Rinse with a damp cloth and dry.

Never use a commercial oven cleaner on any part of your microwave.

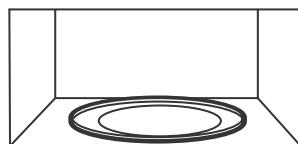

Removable Turntable and Turntable Support

To prevent breakage, do not place the turntable into water just after cooking. Wash it carefully in warm, sudsy water or in the dishwasher. The turntable and support can be broken if dropped. Remember, do not operate the oven without the turntable and support in place.

How to Clean the Outside

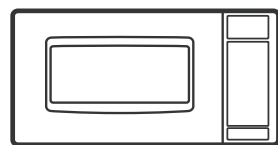

Do not use cleaners containing ammonia or alcohol on the microwave oven. Ammonia or alcohol can damage the appearance of the microwave.

Case

Clean the outside of the microwave with a sudsy cloth. Rinse with a damp cloth and then dry. Wipe the window clean with a damp cloth.

Control Panel and Door

Wipe with a damp cloth. Dry thoroughly. Do not use cleaning sprays, large amounts of soap and water, abrasives or sharp objects on the panel—they can damage it. Some paper towels can also scratch the control panel.

Door Surface

It is important to keep the area clean where the door seals against the microwave. Use only mild, non-abrasive detergents applied with a clean sponge or soft cloth. Rinse well.

Power Cord

If the cord becomes soiled, unplug and wash with a damp cloth. For stubborn spots, sudsy water may be used, but be certain to rinse with a damp cloth and dry thoroughly before plugging cord into outlet.

Before you call for service...



Troubleshooting Tips
Save time and money! Review the chart below and you may not need to call for service.

Problem	Possible Causes	What To Do
Oven will not start	A fuse in your home may be blown or the circuit breaker tripped.	• Replace fuse or reset circuit breaker.
	Power surge.	• Unplug the microwave oven, then plug it back in.
	Plug not fully inserted into wall outlet.	• Make sure the 3-prong plug on the oven is fully inserted into wall outlet.
	Door not securely closed.	• Open the door and close securely.
Control panel lighted, yet oven will not start	Door not securely closed.	• Open the door and close securely.
	START pad not pressed after entering cooking selection.	• Press START .
	Another selection entered already in oven and CANCEL/STOP pad not pressed to cancel it.	• Press CANCEL/STOP .
	CANCEL/STOP was pressed accidentally.	• Reset cooking program and press START .
Microwave oven controls will not work	The control has been locked. (When the control panel is locked, the lock indicator will be lit.)	• Press and hold CANCEL/STOP for about three seconds to unlock the control.

Things That Are Normal With Your Microwave Oven

- Steam or vapor escaping from around the door.
- Light reflection around door or outer case.
- Dimming oven light and change in the blower sound at power levels other than high.
- Dull thumping sound while oven is operating.
- TV/radio interference might be noticed while using the microwave. Similar to the interference caused by other small appliances, it does not indicate a problem with the microwave. Plug the microwave into a different electrical circuit, move the radio or TV as far away from the microwave as possible, or check the position and signal of the TV/radio antenna.

Please place in envelope and mail to:
Veuillez mettre dans une enveloppe et envoyez à :

**OWNERSHIP REGISTRATION
P.O. BOX 1780
MISSISSAUGA, ONTARIO
L4Y 4G1**

**(FOR CANADIAN CONSUMERS ONLY -
POUR RÉSIDENTS CANADIENS SEULEMENT)**



For Canadian
Customers



Pour les
consommateurs
canadiens

CUT ALONG THIS LINE AND RETURN CARD – THANKS
DÉCOUPEZ ICI ET ENVOYEZ LA FICHE – MERCI

OWNERSHIP REGISTRATION CERTIFICATE – FICHE D'INSCRIPTION DU PROPRIÉTAIRE			
Please register your product to enable us to contact you in the remote event a safety notice is issued for this product and to allow for efficient communication under the terms of our warranty, should the need arise.		Veuillez enregistrer votre produit afin de nous permettre de communiquer avec vous si jamais un avis de sécurité concernant ce produit était émis et de communiquer facilement avec vous en vertu de votre garantie, si le besoin s'en fait sentir.	
REGISTER ON-LINE:	www.geappliances.ca	MAIL TO:	P.O. BOX 1780, MISSISSAUGA
ENREGISTREMENT SUR INTERNET À :	www.electromenagersge.ca	POSTEZ À :	ONTARIO, L4Y 4G1
<input type="checkbox"/> MR. / M.	<input type="checkbox"/> MRS. / MME	FIRST NAME / PRÉNOM	LAST NAME / NOM
<input type="checkbox"/> MISS/MLE	<input type="checkbox"/> MS.		
STREET NO / N° RUE		STREET NAME / RUE	
		APT.NO/APP./RR#	
CITY / VILLE		PROVINCE	POSTAL CODE/CODE POSTAL
AREA CODE/IND. RÉG.	TELEPHONE/TÉLÉPHONE	E-MAIL/COURRIEL	
DID YOU PURCHASE A SERVICE CONTRACT FOR THIS APPLIANCE? AVEZ-VOUS ACHETÉ UN CONTRAT DE SERVICE POUR CET APPAREIL ?		YES/OUI NO/NON	<input type="checkbox"/> IF YES/ OUI : EXPIRATION Y/A M DU
NAME OF SELLING DEALER / NOM DU MARCHAND		MODEL / MODÈLE	
INSTALLATION DATE / DATE D'INSTALLATION Y/A M DU	CORRESPONDENCE CORRESPONDANCE	<input type="checkbox"/> ENGLISH <input type="checkbox"/> FRANÇAIS	SERIAL / SÉRIE
<input type="checkbox"/> I do not wish to receive any promotional offers regarding this product. Je ne désire pas recevoir d'offres promotionnelles concernant ce produit.			

GE Microwave Warranty—One Year Limited Warranty.



Staple your receipt here.
Proof of the original purchase date is
needed to make a warranty claim.

For The Period Of: Mabe Will Replace:

One Year

From the date of the
original purchase

Replacement unit for any product which fails due to a defect in materials or workmanship.
The exchange unit is warranted for the remainder of your product's original one-year
warranty period.

In Order to Make a Warranty Claim:

- Properly pack your unit. We recommend using the original carton and packing materials.
- Return the product to the retail location where it was purchased.
- Include in the package a copy of the sales receipt or other evidence of date of original purchase. Also print your name and address and a description of the defect.

What Is Not Covered:

- Customer instruction. This owner's manual provides information regarding operating instructions and user controls.
- Improper installation. If you have an installation problem, contact your dealer or installer. You are responsible for providing adequate electrical connecting facilities.
- Failure of the product resulting from modifications to the product or due to unreasonable use including failure to provide reasonable and necessary maintenance.
- Replacement of house fuses or resetting of circuit breakers.
- Damage to the product caused by improper power supply voltage, accident, fire, floods or acts of God.
- Incidental or consequential damage caused by possible defects with this appliance.

EXCLUSION OF IMPLIED WARRANTIES—Your sole and exclusive remedy is product exchange as provided in this Limited Warranty. Any implied warranties, including the implied warranties of merchantability or fitness for a particular purpose, are limited to one year or the shortest period allowed by law.

This warranty is extended to the original purchaser and any succeeding owner for products purchased for home use within Canada.

Some provinces do not allow the exclusion or limitation of incidental or consequential damages. This warranty gives you specific legal rights, and you may also have other rights which vary from province to province. To know what your legal rights are, consult your local or provincial consumer affairs office.

Exclusion of implied warranties: Except where prohibited or restricted by law, there are no warranties, whether express, oral or statutory which extend beyond the description on the face hereof, including specifically the implied warranties of merchantability or fitness for a particular purpose.

Warrantor: Mabe Canada Inc., Burlington, Ontario

Service Telephone Numbers.



Problem Solver 1-800-361-3400

For answers call Mabe Canada Inc.



In-Home Repair Service 1-800-361-3400

Expert Mabe repair service is only a phone call away.



Service Contracts 1-800-461-3636

Now you can have trouble-free and surprise-free service for as long as you own your appliance. While your warranty is still in effect, you can purchase a MABE SERVICE CONTRACT. For one low fee...just pennies a day...Mabe Customer Service will take care of the repairs your appliance needs - both parts and labour.

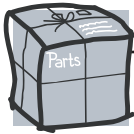

Parts and Accessories 1-800-263-0686

Individuals qualified to service their own appliances can have parts or accessories sent directly to their homes.

Instructions contained in this manual cover procedures to be performed by any user. Other servicing generally should be referred to qualified service personnel. Caution must be exercised, since improper servicing may cause unsafe operation.



Service Satisfaction

If you are not satisfied with the service you receive from Mabe, follow these steps. **First**, contact the people who serviced your appliance.

Next, if you are still not pleased, write all the details—including your phone number—to:

Manager, Consumer Relations,
Mabe Canada Inc.
Suite 310, 1 Factory Lane
Moncton, NB E1C 9M3.