



# Microwave Oven

**Safety Instructions**.....2-5

**Operating Instructions**

Exhaust Features..... 20, 21  
Microwave Terms .....15  
MyPlate Feature .....12  
Oven Features .....7, 8  
Other Features..... 16, 17  
Power Levels.....15  
Replacing the Light Bulb.....20  
Sensor Features.....13-14  
Time Features.....9-11

**Care and Cleaning** .....18

**Troubleshooting Tips**

Before you call for Service...22-24

**Consumer Support**

Consumer Support.....Back Cover  
Optional Kits.....6  
Product registration .....25  
Warranty .....27

**Owner's Manual**

PVM9195

Write the model and serial numbers here:

Model # \_\_\_\_\_

Serial # \_\_\_\_\_

You can find them on a label when the door is open.

# IMPORTANT SAFETY INSTRUCTIONS.

## READ ALL INSTRUCTIONS BEFORE USING.

---

### **▲ WARNING!**

To reduce risk of burns, electric shock, fire, personal injury or exposure to excessive microwave energy.

### **PRECAUTIONS TO AVOID POSSIBLE EXPOSURE TO EXCESSIVE MICROWAVE ENERGY**

- (a) **Do Not Attempt** to operate this oven with the door open since open-door operation can result in harmful exposure to microwave energy. It is important not to defeat or tamper with the safety interlocks.
- (b) **Do Not Place** any object between the oven front face and the door or allow soil or cleaner residue to accumulate on sealing surfaces.
- (c) **Do Not Operate** the oven if it is damaged. It is particularly important that the oven door close properly and that there is no damage to the:
  - (1) door (bent),
  - (2) hinges and latches (broken or loosened),
  - (3) door seals and sealing surfaces.
- (d) **The Oven Should Not** be adjusted or repaired by anyone except properly qualified service personnel.

## IMPORTANT SAFETY INSTRUCTIONS.

---

Use this appliance only for its intended purpose as described in this Owner's Manual.

When using electrical appliances basic safety precautions should be followed, including the following:

- Read and follow the specific precautions in the PRECAUTIONS TO AVOID POSSIBLE EXPOSURE TO EXCESSIVE MICROWAVE ENERGY section above.
- This appliance must be grounded. Connect only to a properly grounded outlet. See the *GROUNDING INSTRUCTIONS* section on page 5.
- Install or locate this appliance only in accordance with the provided installation instructions.
- This microwave oven is not approved or tested for marine use.
- Do not mount this appliance over a sink.
- Do not operate this appliance if it has a damaged power cord or plug, if it is not working properly, or if it has been damaged or dropped.
- Do not cover or block any openings on the appliance.
- Use this appliance only for its intended use as described in this manual. Do not use corrosive chemicals or vapors in this appliance. This microwave oven is specifically designed to heat, dry or cook food, and is not intended for laboratory or industrial use.
- Do not store this appliance outdoors. Do not use this product near water—for example, in a wet basement, near a swimming pool, near a sink or in similar locations.
- Do not let cord hang over edge of table or counter.
- Do not store anything directly on top of the appliance when it is in operation.
- Keep power cord away from heated surfaces.
- Do not immerse power cord or plug in water.
- To reduce the risk of fire in the oven cavity:
  - Do not overcook food. Carefully attend appliance when paper, plastic or other combustible materials are placed inside the oven while cooking.
  - Remove wire twist-ties and metal handles from paper or plastic containers before placing them in the oven.
  - Do not use the oven for storage purposes. Do not leave paper products, cooking utensils or food in the oven when not in use.
  - If materials inside the oven ignite, keep the oven door closed, turn the oven off and disconnect the power cord, or shut off power at the fuse or circuit breaker panel. If the door is opened, the fire may spread.
- See door surface cleaning instructions in the Care and cleaning of the microwave oven section of this manual. Do not use cleaners with ammonia or alcohol on the microwave oven. Ammonia and alcohol can damage the appearance of the microwave.
- Mabe Canada does not support any servicing of this microwave oven, except as described by the Consumer Support sections of this manual. Do not attempt to service the microwave oven yourself. If service is desired, this appliance should be serviced only by qualified service personnel. Contact the nearest authorized service facility for examination, repair or adjustment.
- As with any appliance, close supervision is necessary when used by children.

## SAVE THESE INSTRUCTIONS

## **⚠ WARNING!**

### **IMPORTANT SAFETY INSTRUCTIONS.**

- Do not clean with metal scouring pads. Pieces can burn off the pad and touch electrical parts involving risk of electric shock.
- This microwave oven is cUL listed for installation over both

gas (less than 60,000BTU) and electric ranges.

- This over-the-range oven is designed for use over ranges no wider than 36" (91.4 cm). It may be installed over both gas and electric cooking equipment. .

## **ARCING**

If you see arcing, press the **Cancel/Off** pad and correct the problem.

Arcing is the microwave term for sparks in the oven. Arcing is caused by:

- Metal or foil touching the side of the oven.
- Foil not molded to food.
- Plates or dishes with metallic trim or glaze with a metallic sheen.

- Metal, such as twist-ties, poultry pins or gold-rimmed dishes, in the microwave.
- Recycled paper towels containing small metal pieces being used in the microwave.

## **FOODS**

- Do not pop popcorn in your microwave oven unless in a special microwave popcorn accessory or unless you use popcorn labeled for use in microwave ovens.
- Some products such as whole eggs and sealed containers—for example, closed jars—are able to explode and should not be heated in this microwave oven. Such use of the microwave oven could result in injury.
- Do not boil eggs in a microwave oven. Pressure will build up inside egg yolk and will cause it to burst, possibly resulting in injury.
- Operating the microwave with no food inside for more than a minute or two may cause damage to the oven and could start a fire. It increases the heat around the magnetron and can shorten the life of the oven.
- Foods with unbroken outer "skin" such as potatoes, hot dogs, sausages, tomatoes, apples, chicken livers and other giblets and egg yolks should be pierced to allow steam to escape during cooking.
- Avoid heating baby food in glass jars, even with the lid off. Make sure all infant food is thoroughly cooked. Stir food to distribute the heat evenly. Be careful to prevent scalding when warming formula. The container may feel cooler than the formula really is. Always test the formula before feeding the baby.
- Don't defrost frozen beverages in narrow-necked bottles (especially carbonated beverages). Even if the container is opened, pressure can build up. This can cause the container to burst, possibly resulting in injury.

### **■ SUPERHEATED WATER**

*Liquids, such as water, coffee or tea are able to be overheated beyond the boiling point without appearing to be boiling. Visible bubbling or boiling when the container is removed from the microwave oven is not always present. THIS COULD RESULT IN VERY HOT LIQUIDS SUDDENLY BOILING OVER WHEN THE CONTAINER IS DISTURBED OR A SPOON OR OTHER UTENSIL IS INSERTED INTO THE LIQUID.*

To reduce the risk of injury to persons:

- Do not overheat the liquid.
- Stir the liquid both before and halfway through heating it.
- Do not use straight-sided container with narrow necks.
- After heating, allow the container to stand in the microwave oven for a short time before removing the container.
- Use extreme care when inserting a spoon or other utensil into the container.
- Hot foods and steam can cause burns. Be careful when opening any containers of hot food, including popcorn bags, cooking pouches and boxes. To prevent possible injury, direct steam away from hands and face.
- Do not overcook potatoes. They could dehydrate and catch fire, causing damage to your oven.
- Cook meat and poultry thoroughly—meat to at least an INTERNAL temperature of 160°F (71°C) and poultry to at least an INTERNAL temperature of 180°F (82°C). Cooking to these temperatures usually protects against foodborne illness.

**SAVE THESE INSTRUCTIONS**

# IMPORTANT SAFETY INFORMATION. READ ALL INSTRUCTIONS BEFORE USING.

---

## ▲ WARNING!

Make sure all cookware used in your microwave oven is suitable for microwaving. Most glass casseroles, cooking dishes, measuring cups, custard cups, pottery or china dinnerware which does not have metallic trim or glaze with a metallic sheen can be used. Some cookware is labeled "suitable for microwaving."

- If you are not sure if a dish is microwave-safe, use this test: Place in the oven both the dish you are testing and a glass measuring cup filled with 1 cup (240 mL) of water—set the measuring cup either in or next to the dish. Microwave 30–45 seconds at high. If the dish heats, it should not be used for microwaving.  
  
If the dish remains cool and only the water in the cup heats, then the dish is microwave-safe.
- If you use a meat thermometer while cooking, make sure it is safe for use in microwave ovens.
- Do not use recycled paper products. Recycled paper towels, napkins and waxed paper can contain metal flecks which may cause arcing or ignite. Paper products containing nylon or nylon filaments should be avoided, as they may also ignite.
- Some foam trays (like those that meat is packaged on) have a thin strip of metal embedded in the bottom. When microwaved, the metal can burn the floor of the oven or ignite a paper towel.
- Do not use the microwave to dry newspapers.
- Not all plastic wrap is suitable for use in microwave ovens. Check the package for proper use.
- Paper towels, waxed paper and plastic wrap can be used to cover dishes in order to retain moisture and prevent spattering. Be sure to vent plastic wrap so steam can escape.

- Cookware may become hot because of heat transferred from the heated food. Pot holders may be needed to handle the cookware.
- "Boilable" cooking pouches and tightly closed plastic bags should be slit, pierced or vented as directed by package. If they are not, plastic could burst during or immediately after cooking, possibly resulting in injury. Also, plastic storage containers should be at least partially uncovered because they form a tight seal. When cooking with containers tightly covered with plastic wrap, remove covering carefully and direct steam away from hands and face.
- Use foil only as directed in this guide. TV dinners may be microwaved in foil trays less than 3/4" (1.9 cm) high; remove the top foil cover and return the tray to the box. When using foil in the microwave oven, keep the foil at least 1" (2.5 cm) away from the sides of the oven.
- Plastic cookware—Plastic cookware designed for microwave cooking is very useful, but should be used carefully. Even microwave-safe plastic may not be as tolerant of overcooking conditions as are glass or ceramic materials and may soften or char if subjected to short periods of overcooking. In longer exposures to overcooking, the food and cookware could ignite.

*Follow these guidelines:*

1. Use microwave-safe plastics only and use them in strict compliance with the cookware manufacturer's recommendations.
2. Do not microwave empty containers.
3. Do not permit children to use plastic cookware without complete supervision.

## THE VENT FAN

---

The fan will operate automatically under certain conditions (see Automatic Fan feature). Take care to prevent the starting and spreading of accidental cooking fires while the vent fan is in use.

- Clean the underside of the microwave often.  
Do not allow grease to build up on the microwave or the fan filters.
- In the event of a grease fire on the surface units below the microwave oven, smother a flaming pan on the surface unit by covering the pan completely with a lid, a cookie sheet or a flat tray.
- Use care when cleaning the vent fan filters. Corrosive cleaning agents, such as lye-based oven cleaners, may damage the filters.
- When preparing flaming foods under the microwave, turn the fan on.
- Never leave surface units beneath your microwave oven unattended at high heat settings. Boilovers cause smoking and greasy spillovers that may ignite and spread if the microwave vent fan is operating. To minimize automatic fan operation, use adequate sized cookware and use high heat on surface units only when necessary.

**SAVE THESE INSTRUCTIONS**

## GROUNDING INSTRUCTIONS

**⚠️ WARNING**—Improper use of the grounding plug can result in a risk of electric shock.

This appliance must be grounded. In the event of an electrical short circuit, grounding reduces the risk of electric shock by providing an escape wire for the electric current.

This appliance is equipped with a power cord having a grounding wire with a grounding plug. The plug must be plugged into an outlet that is properly installed and grounded.

Consult a qualified electrician or service technician if the GROUNDING INSTRUCTIONS are not completely understood, or if doubt exists as to whether the appliance is properly grounded.

If the outlet is a standard 2-prong wall outlet, it is your personal responsibility and obligation to have it replaced with a properly grounded 3-prong wall outlet.

Do not under any circumstances cut or remove the third (ground) prong from the power cord.

We do not recommend using an extension cord with this appliance. If the power cord is too short, have a qualified electrician or service technician install an outlet near the appliance. (See EXTENSION CORDS section.)

For best operation, plug this appliance into its own electrical outlet to prevent flickering of lights, blowing of fuse or tripping of circuit breaker.

## ADAPTER PLUGS

**Usage situations where appliance's power cord will be disconnected infrequently.**

Because of potential safety hazards under certain conditions, **we strongly recommend against the use of an adapter plug.** However, if you still elect to use an adapter, where local codes permit, a **TEMPORARY CONNECTION** may be made to a properly grounded wall receptacle by the use of a UL listed adapter which is available at most local hardware stores.

The larger slot in the adapter must be aligned with the larger slot in the wall receptacle to provide proper polarity in the connection of the power cord.

**CAUTION:** Attaching the adapter ground terminal to the wall receptacle cover screw does not ground the appliance unless the cover screw is metal, and not insulated, and the wall receptacle is grounded through the house wiring.

You should have the circuit checked by a qualified electrician to make sure the receptacle is properly grounded.

When disconnecting the power cord from the adapter, always hold the adapter with one hand. If this is not done, the adapter ground terminal is very likely to break with repeated use. Should this happen, **DO NOT USE** the appliance until a proper ground has again been established.

**Usage situations where appliance's power cord will be disconnected frequently.**

**Do not use an adapter plug** in these situations because frequent disconnection of the power cord places undue strain on the adapter and leads to eventual failure of the adapter ground terminal. You should have the 2-prong wall receptacle replaced with a 3-prong (grounding) receptacle by a qualified electrician before using the appliance.

## PACEMAKERS

Most pacemakers are shielded from interference from electronic products, including microwaves. However, patients with pacemakers may wish to consult their physicians if they have concerns.

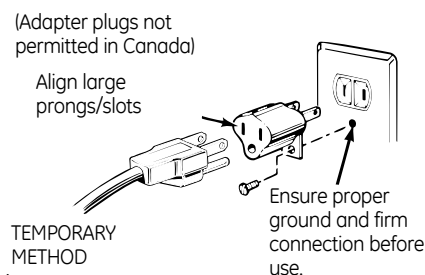

**READ AND FOLLOW THIS SAFETY INFORMATION CAREFULLY.**

**SAVE THESE INSTRUCTIONS**

## Optional kits

---

Available at extra cost from your GE supplier.

### Filler Panel Kits

- JX52WH—White
- JX52BL—Black

When replacing a 36" (91.4 cm) range hood, filler panel kits fill in the additional width to provide a custom built-in appearance.

For installation between cabinets only; not for end-of-cabinet installation. Each kit contains two 3" (7.6 cm) wide filler panels.

### Filter Kits

- Sales No. JX81H—Recirculating Charcoal Filter Kit  
Service No. WB02X10956

Filter kits are used when the oven cannot be vented to the outside.

See back cover to order by phone or at [GEApplianceparts.com](http://GEApplianceparts.com).

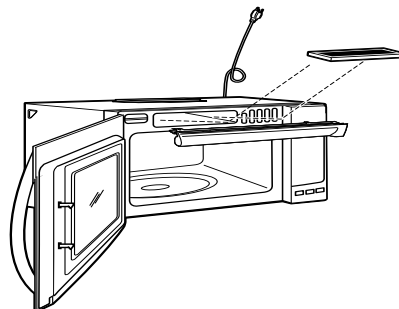

# About the features of your oven.

Throughout this manual, features and appearance may vary from your model.

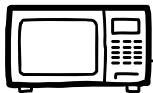
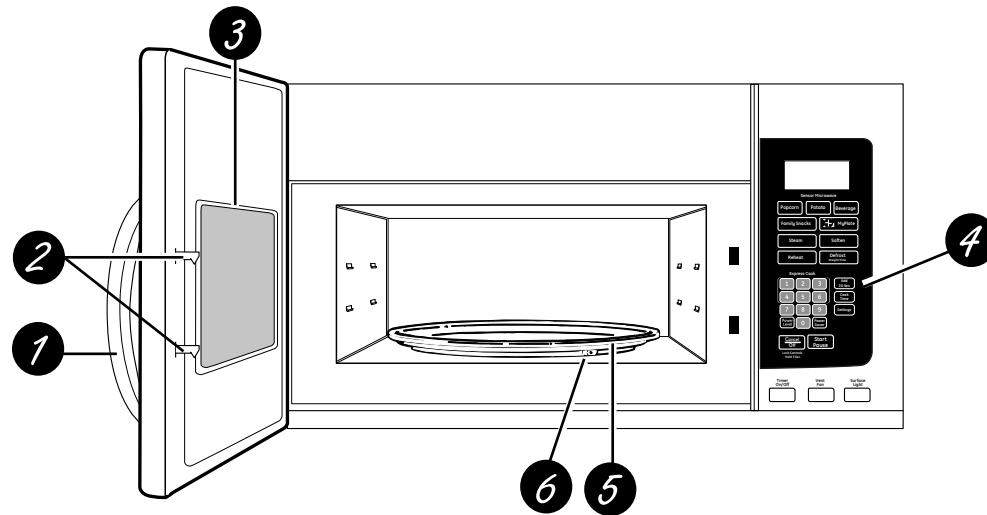

## Features of the Oven

- 1 Door Handle.**
- 2 Door Latches.**
- 3 Window with Metal Shield.** Screen allows cooking to be viewed while keeping microwaves confined in the oven.
- 4 Control Panel.**
- 5 Removable Turntable.** Do not operate the oven in the microwave mode without the turntable and turntable support seated and in place.
- 6 Removable Turntable Support.** Do not operate the oven in the microwave mode without the turntable and turntable support seated and in place.

## Power Saver Feature (on some models)

Your GE microwave has an Power Saver feature. Many electronic appliances, including Microwaves, consume electric power while they are switched off or in a standby mode. Eliminating standby power can reduce your operating costs.

To **ACTIVATE** the Power Saver Feature—

Press the **Power Saver** button on the unit. The unit will display “Power Saver is On.” Once the unit has been in standby mode (no buttons pressed or cooking performed) for one minute, the display will turn off.

**NOTE:** The clock will not display in this mode. When a button is pressed, the display will turn on throughout the operation and remain on until the unit has been in standby for one minute.

To **DEACTIVATE** the Power Saver Feature —

Press the **Power Saver** button on the unit. The display will come on and will read “Power Saver is Off.” The display will remain on despite the length of time in standby mode.

# About the cooking features of your microwave oven.

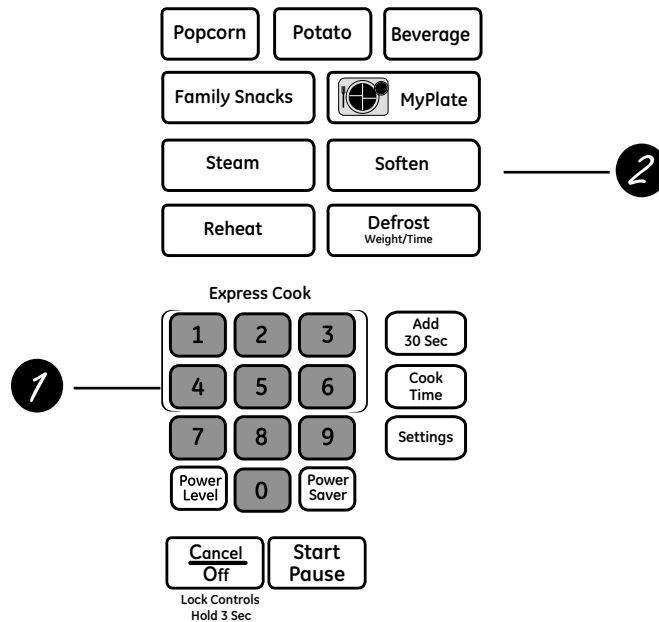

## Cooking Controls

Check the Convenience Guide before you begin.

### 1 Time Features

Press	Enter
COOK TIME	Amount of cooking time
DEFROST	Time, Weight or 1lb Quick Defrost
SETTINGS	
TIMER	
POWER LEVEL	Power level 1 to 10
ADD 30 SEC	Starts immediately!
EXPRESS COOK	Starts immediately! Press number pads (1-6)
POPCORN	Starts immediately!
BEVERAGE	Starts immediately!

### 2 Sensor Features

Press	Enter
REHEAT	Starts immediately!
FAMILY SNACKS	Enter pad to select Food
SOFTEN	Enter pad to select Food
STEAM	Enter pad to select Food
MyPlate	Enter pad to select Food
POTATO	Starts immediately!



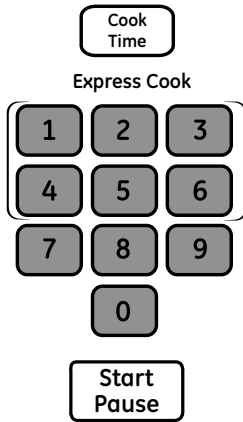

## Cook Time

Allows you to microwave for any time up to 99 minutes and 99 seconds.

**Power level 10 (HIGH)** is automatically set, but you may change it for more flexibility.

- 1 Press **Cook Time**.
- 2 Enter cooking time.
- 3 Press **Start** or change power level. (Press **Power Level** to adjust power level.)
- 4 Press **Start** if power setting is chosen.

You may open the door during **Cook Time** to check the food. Close the door and press **Start** to resume cooking.

---

## Express Cook

This is a quick way to set cooking time for 1-6 minutes.

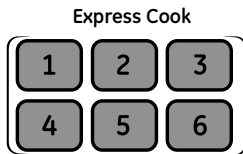

- 1 Press one of the **Express Cook** pads (from 1-6) for 1-6 minutes of cooking at **power level 10**.

For example, press the **2** pad for 2 minutes of cooking time.

The power level can be changed as time is counting down. Press **POWER LEVEL** and enter 0-10.

**NOTE:** **Express Cook** function pertains to pads 1-6 only.

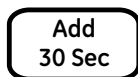

## Add 30 Sec

It will add 30 seconds to the time counting down each time the pad is pressed. Each touch will add 30 seconds, up to 99 minutes and 99 seconds.

The oven will start immediately when pressed.

# About the time features.

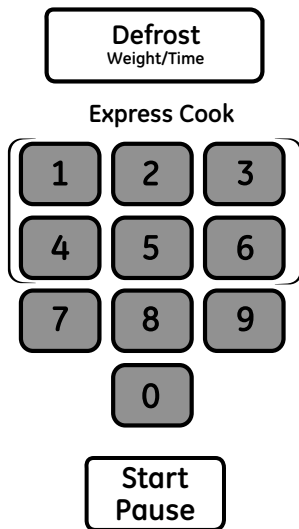

## Time Defrost

Allows you to defrost for a selected length of time. See the Defrosting Guide for suggested times. (**Time Defrost** and **1 lb Quick Defrost** explained in the *About the convenience features* section.)

- 1 Press **DEFROST** twice.
- 2 Enter defrosting time.
- 3 Press **START**.
- 4 Turn the food over after half the time.

At one half of selected defrosting time, turn food over and break apart or rearrange pieces for more even defrosting. Shield any warm areas with small pieces of foil. The oven will continue to defrost if you don't open the door and turn the food.

A dull thumping noise may be heard during defrosting. This is normal when oven is not operating at **High** power.

## Defrosting Tips

- Foods frozen in paper or plastic can be defrosted in the package. Closed packages should be slit, pierced or vented **AFTER** food has partially defrosted. Plastic storage containers should be partially uncovered.
- Family-size, prepackaged frozen dinners can be defrosted and microwaved. If the food is in a foil container, transfer it to a microwave-safe dish.
- Foods that spoil easily should not be allowed to sit out for more than one hour after defrosting. Room temperature promotes the growth of harmful bacteria.
- For more even defrosting of larger foods, such as roasts, use **Time Defrost**. Be sure large meats are completely defrosted before cooking.
- When defrosted, food should be cool but softened in all areas. If still slightly icy, return to the microwave very briefly, or let it stand a few minutes.

## Defrosting Guide

Food	Time	Comments
<b>Breads, Cakes</b> <i>Bread, buns, or rolls</i> (1 piece) <i>Sweet rolls</i> (approx. 12 oz./340 g)	1/4 min. 2 to 4 min.	Rearrange after half the time.
<b>Fish and Seafood</b> <i>Fillets, frozen</i> (1 lb./454 g)	6 to 9 min.	
<b>Fruit</b> <i>Plastic pouch—1 or 2</i> (10-oz./283 g package)	1 to 5 min.	
<b>Meat</b> <i>Bacon</i> (1 lb./454 g) <i>Franks</i> (1 lb./454 g)  <i>Ground meat</i> (1 lb./454 g) <i>Roast: beef, lamb, veal, pork</i>  <i>Steaks, chops and cutlets</i>	2 to 5 min. 2 to 5 min. 4 to 6 min. 9 to 13 min. per lb. (454 g) 4 to 8 min. per lb. (454 g)	Place unopened package in oven. Let stand 5 minutes after defrosting. Place unopened package in oven. Microwave just until franks can be separated. Let stand 5 minutes, if necessary, to complete defrosting. Turn meat over after first half of time. Use power level 10. Place unwrapped meat in cooking dish. Turn over after first half of time and shield warm areas with foil. After second half of time, separate pieces with table knife. Let stand to complete defrosting.
<b>Poultry</b> <i>Chicken, broiler-fryer, cut up</i> (2½ to 3 lbs./1.1 to 1.4 kg)  <i>Chicken, whole</i> (2½ to 3 lbs./1.1 to 1.4 kg)  <i>Cornish hen</i>  <i>Turkey breast</i> (4 to 6 lbs./1.8 to 2.7 kg)	14 to 20 min. 20 to 25 min. 7 to 13 min. per lb. (454 g) 3 to 8 min. per lb. (454 g)	Place wrapped chicken in dish. Unwrap and turn over after first half of time. After second half of time, separate pieces and place in cooking dish. Microwave 2 to 4 minutes more, if necessary. Let stand a few minutes to finish defrosting. Place wrapped chicken in dish. After half the time, unwrap and turn chicken over. Shield warm areas with foil. To complete defrosting, run cold water in the cavity until giblets can be removed. Place unwrapped hen in the oven breast-side-up. Turn over after first half of time. Run cool water in the cavity until giblets can be removed. Place unwrapped breast in microwave-safe dish breast-side-down. After first half of time, turn breast-side-up and shield warm areas with foil. Defrost for second half of time. Let stand 1 to 2 hours in refrigerator to complete defrosting.

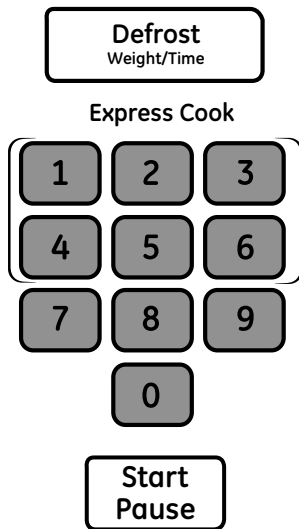

## Weight Defrost

Use **Weight Defrost** for meat, poultry and fish.

Use **Time Defrost** for most other frozen foods.

- 1 Press **DEFROST** once.
- 2 Using the conversion guide below, enter food weight. For example, press pads 1 and 2 for 1.2 pounds (544 g) (1 pound, 3 ounces).
- 3 Press **START**.
- 4 Turn the food over when prompted.

(Time Defrost is explained in the *About the Time Features* section.)

### Defrosting Tips

- Remove meat from package and place on microwave-safe dish.

- When the oven signals, turn the food over. Remove defrosted meat or shield warm areas with small pieces of foil.
- After defrosting, most meats need to stand 5 minutes to complete defrosting. Large roasts should stand for about 30 minutes.

## Conversion Guide

If the weight of food is stated in pounds and ounces, the ounces must be converted to tenths (.1) of a pound.

Ounces	Pounds
1-2 (28-56 g)	.1
3 (85 g)	.2
4-5 (113-141 g)	.3
6-7 (170-198 g)	.4
8 (227 g)	.5
9-10 (255-283 g)	.6
11 (312 g)	.7
12-13 (340-368 g)	.8
14-15 (397-425 g)	.9

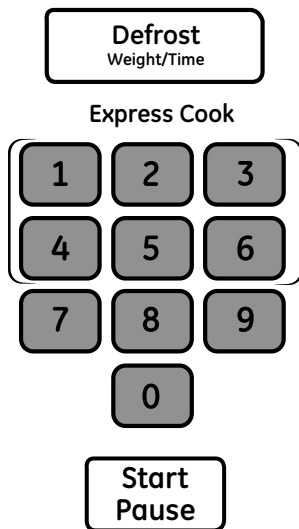

## 1 lb Quick Defrost

1 lb Quick Defrost automatically sets the defrosting times and power levels to give even defrosting results for meats, poultry and fish weighing up to one pounds.

- 1 Press **DEFROST** three times.
- 2 Press **START**.
- 3 Turn the food over when prompted.



## Popcorn

To use the **Popcorn** feature:

- 1 Follow package instructions, using **Cook** if the package is less than 1.0 ounces or larger than 3.5 ounces. Place the package of popcorn in the center of the turntable.
- 2 Press the **POPCORN** button once for 3.3 to 3.5 ounce bags or twice for 2.7 to 3.0 ounce bags or three times for 1.0 to 1.5 ounce bags.

If food is undercooked after the countdown, use **Time Cook** for additional cooking time.

Use only with prepackaged microwave popcorn weighing 1.0 to 3.5 ounces.

**NOTE: Do not use this feature twice in succession on the same food portion—it may result in severely overcooked or burnt food**

# About the MyPlate Feature.

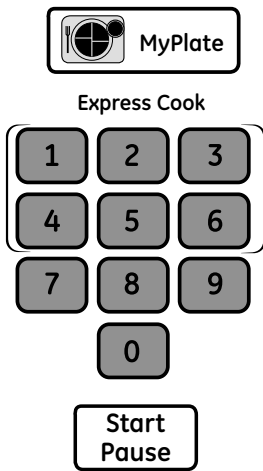

**NOTE:** Do not use the sensor features twice in succession on the same food portion. If food is undercooked after the first countdown, use Cook Time for additional time.

## MyPlate Feature

Allows you to microwave healthy food choices by servings or with sensor.

- 1** Press **MyPlate** pad.
- 2** Enter the food type. See *Cooking Guide for MyPlate* below for codes or check the display for food types.
- 3** Enter the amount as prompted for non-sensor food selections.  
**NOTE FOR SENSOR COOKING:** for best results do not open the door while cooking.
- 4** Press **START**.  
**NOTE FOR SENSOR COOKING:** for best results do not open the door while cooking

For non-sensor food, you may open the door during cooking to check the food. Close the door and press **START** to resume cooking.

## Cooking Guide for MyPlate Feature

**NOTE:** Use **power level 10** unless otherwise noted.

First Choice	Second Choice	Third Choice
Grain	Rice	1/2 cup (120 mL), 1 cup (240 mL), 1-1/2 cups (360 mL)
	Oatmeal	1 to 4 packets
	Popcorn	1oz (28 g), 3.0 ozs (85 g), 3.5 ozs (100 g)
	Macaroni	1/2 cup (120 mL), 1 cup (240 mL), 1-1/2 cups (360 mL)
	Quinoa	1/2 cup (120 mL), 1 cup (240 mL), 1-1/2 cups (360 mL)
Vegetables	Asparagus	Fresh, Frozen, Canned
	Broccoli	Fresh, Frozen
	Canned Beans	Canned
	Green Beans	Fresh, Frozen, Canned
	Carrots	Fresh, Frozen, Canned
	Corn	Fresh Whole Cobs (1 to 4), Frozen Kernel, Canned
	Green Peas	Frozen, Fresh, Canned
	Potato	Baking, Sweet
	Spinach	Frozen, Fresh, Canned
Ground Meat		
Poultry	Bone-in Chicken	
	Bonless Chicken	
Seafood	Salmon	
	Tilapia	
	Whitefish	

## Family Snacks

### Family Snacks

Use the **Family Snacks** feature to cook from a variety of pre-programmed family snack items.

- 1 Press the **Family Snacks** button.
- 2 Enter the number pad to select the food you wish to cook. Press the dial to enter
- 3 Enter an amount for the snack selected.
- 4 Press **START/PAUSE** to start cooking.

First Choice	Second Choice
Burrito	1 to 3
Chicken Nuggets	1 to 2 servings
Oatmeal	1 to 4 packets
Instant Macaroni and Cheese	1 to 2 servings
Canned Pasta	1 to 2 cans
Hot Dogs	1 to 4
Frozen Microwave Pizza	
Hot Chocolate	1 to 3 cups (240 to 720 mL)

## Soften

### Soften (on some models)

Use the **Soften** feature to soften certain pre-programmed foods:

- 1 Press the **Soften** button.
- 2 Enter the number pad to select one of the soften options.
- 3 Enter an amount for the food selected.
- 4 Press **Start/Pause** to start cooking.

First Choice	Second Choice
Butter	1/2 Stick; 1 Stick; 2 Sticks
Cream Cheese	3 oz. (85 g); 8 oz. (227 g)
Ice Cream	1 pint (1/2 l); 1 quart (1 l);

## Steam

### Steam

Use the **Steam** feature to steam certain pre-programmed foods. For best performance, please use a NordicWare Rice Cooker/Steamer Bowl.

- 1 Press the **Steam** button.
- 2 Select the food you wish to steam.
- 3 Place steamer bowl with water, salt (if necessary), and food in the microwave with the steam vents on the steamer bowl in the OPEN position.
- 4 Press **Start** to begin cooking.
- 5 When prompted, open the door and CLOSE the steam vents on the steamer bowl.  
NOTE: Make sure to open the door and close the steam vents on the steamer bowl when prompted. If the **Start** button is pressed before opening the door, the oven will display the "Insert Food" message.
- 6 Close the door and press **Start/Pause** to resume cooking.

**NOTE:** The NordicWare Rice Cooker/Steamer Bowl should be used for best cooking results

First Choice	Second Choice
1 - Rice	1 - 1 cup (240 mL) white, 2 - 1 cup (240 mL) brown
2 - Asparagus	1 to 2 cups (240 to 480 g)
3 - Broccoli	1 to 2 cups (240 to 480 g)
4 - Brussel Sprouts	1 to 2 cups (240 to 480 g)
5 - Carrots	1 to 2 cups (240 to 480 g)
6 - Cauliflower	1 to 2 cups (240 to 480 g)
7 - Zucchini	1 to 2 cups (240 to 480 g)

# About the sensor microwave features.

## Reheat

### Reheat

*Do not use the shelves when microwave cooking.)*

The **Reheat** feature reheats servings of previously cooked foods or a plate of leftovers.

- 1 Place the cup of liquid or covered food in the oven. Press **REHEAT** once, twice, or three times. The oven starts immediately.  
Press once for a plate of leftovers.  
Press twice for a pasta.  
Press three times for 1/2 to 2 cups (120 to 480 mL) of vegetables.

- 2 The oven signals when steam is sensed and the time remaining begins counting down.

Do not open the oven door until time is counting down. If the door is opened, close it and press **START/PAUSE** immediately.

*After removing food from the oven, stir, if possible, to even out the temperature. Reheated foods may have wide variations in temperature. Some areas of food may be extremely hot.*

If food is not hot enough after the countdown use **Cook Time** for additional reheating time.

### Some Foods Not Recommended for Use With Reheat

It is best to use **Cook Time** for these foods:

- Bread products.
- Foods that must be reheated uncovered.
- Foods that need to be stirred or rotated.
- Foods calling for a dry look or crisp surface after reheating.

**NOTE: Do not use this feature twice in succession on the same food portion—it may result in severely overcooked or burnt food.**



Covered

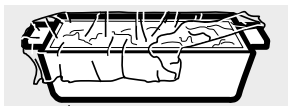

Vented

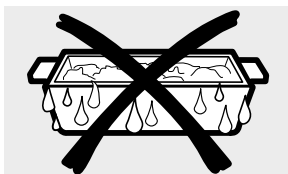

Dry off dishes so they don't mislead the sensor.

### Humidity Sensor

#### What happens when using the Sensor Features:

The Sensor Features detect the increasing humidity released during cooking. The oven automatically adjusts the cooking time to various types and amounts of food.

Do not use the Sensor Features twice in succession on the same food portion—it may result in severely overcooked or burnt food. If food is undercooked after the countdown, use **TIME COOK** for additional cooking time.

- The proper containers and covers are essential for best sensor cooking.
- Always use microwave-safe containers and cover them with lids or vented plastic wrap. Never use tight sealing plastic containers—they can prevent steam from escaping and cause food to overcook.
- Be sure the outside of the cooking containers and the inside of the microwave oven are dry before placing food in the oven. Beads of moisture turning into steam can mislead the sensor.

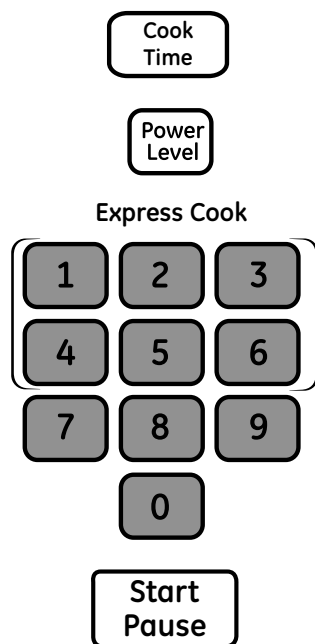

### Changing the Power Level

The power level may be entered or changed after entering the time for **CookTime**.

- 1** Press **Cook Time** button once.
- 2** Enter cooking time.
- 3** Enter **Power Level**.
- 4** Press **Start**.

Variable power levels add flexibility to microwave cooking. The power levels on the microwave oven can be compared to the surface units on a range. Each power level gives you microwave energy a certain percent of the time. **Power level 7** is microwave energy 70% of the time. **Power level 3** is energy 30% of the time. Most cooking will be done on High (power level 10) which gives you 100% power. **Power level 10** will cook faster but food may need more frequent stirring, rotating or turning over. A lower setting will cook more evenly and need less stirring or rotating of the food. Some foods may have better flavor, texture or appearance if one of the lower settings is used. Use a lower power level when cooking foods that have a tendency to boil over, such as scalloped potatoes.

Rest periods (when the microwave energy cycles off) give time for the food to “equalize” or transfer heat to the inside of the food. An example of this is shown with **power level 3**—the defrost cycle. If microwave energy did not cycle off, the outside of the food would cook before the inside was defrosted.

Here are some examples of uses for various power levels:

**High 10:** Fish, bacon, vegetables, boiling liquids.

**Med-High 7:** Gentle cooking of meat and poultry; baking casseroles and reheating.

**Medium 5:** Slow cooking and tenderizing for stews and less tender cuts of meat.

**Low 2 or 3:** Defrosting; simmering; delicate sauces.

**Warm 1:** Keeping food warm; softening butter.

**NOTE:** You can also change the power level during many cooking modes by pressing the power level button entering a valid power level.

## Microwave terms.

Term	Definition
<b>Arcing</b>	Arcing is the microwave term of sparks in the oven. Arcing is caused by: <ul style="list-style-type: none"> <li>• metal or foil touching the side of the oven.</li> <li>• foil that is not molded to food (upturned edges act like antennas).</li> <li>• metal such as twist-ties, poultry pins, gold-rimmed dishes.</li> <li>• recycled paper towels containing small metal pieces.</li> </ul>
<b>Covering</b>	Covers hold in moisture, allow for more even heating and reduce cooking time. Venting plastic wrap or covering with wax paper allows excess steam to escape.
<b>Shielding</b>	In a regular oven, you shield chicken breasts or baked foods to prevent over-browning. When microwaving, you use small strips of foil to shield thin parts, such as the tips of wings and legs on poultry, which would cook before larger parts.
<b>Standing Time</b>	When you cook with regular ovens, foods such as roasts or cakes are allowed to stand to finish cooking or to set. Standing time is especially important in microwave cooking. Note that a microwaved cake is not placed on a cooling rack.
<b>Venting</b>	After covering a dish with plastic wrap, you vent the plastic wrap by turning back one corner so excess steam can escape.

## About the other features.

---

### Cooking Complete Reminder

To remind you that you have food in the oven, the oven will display YOUR FOOD IS READY and beep once a minute until you either open the oven door or press the **Cancel/Off** button.

---



### Clock

Press the **Settings** button to enter the time of day.

- 1 Press the **Settings** button two times.
  - 2 Enter the appropriate time of day.
  - 3 Press **Settings** to select AM or PM.
  - 4 Press **Settings** to accept the time.
- 



### Start/Pause

In addition to starting many functions, **START/PAUSE** allows you to stop cooking without opening the door or clearing the display.

---



### Cancel/Off

Press the **CANCEL/OFF** button to stop and cancel cooking at any time.

---



### Control lock out

You may lock the control panel to prevent the oven from being accidentally started during cleaning or being used by children.

Lock Controls  
Hold 3 Sec

To lock or unlock the controls, press and hold the **Cancel/Off** button for about three seconds. When the control panel is locked, **CONTROL LOCKED** will be displayed briefly anytime a button or dial is pressed.

---

### Surface Light



### Surface Light

Press **SURFACE LIGHT** once for bright light, twice for the night light or a third time to turn the light off.

---

### Timer On/Off

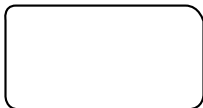

### Timer

The **Timer** operates as a minute timer and can be used at any time, even when the oven is operating.

- 1 Press the **TIMER on/off** button.
- 2 Enter a time.
- 3 Press the **TIMER on/off** button to start.

To cancel, press the **TIMER on/off** button.

When time is up, the oven will signal.

To turn off the timer signal, press **TIMER on/off**.

---

**NOTE:** The **TIMER** indicator will be lit while the timer is operating.



**Settings**
**Turntable On/Off**

For best cooking results, leave the turntable on. It can be turned off for large dishes.

- 1** Press the **Settings** button three times.
- 2** Select **ON** or **OFF** as prompted.

Sometimes the turntable can become too hot to touch.

Be careful touching the turntable during and after cooking.

Some cooking modes do not allow the turntable to be turned off.

**Settings**
**Sound Level**

Use to set the beeper volume level.

- 1** Press the **Settings** button five times.
- 2** Press **0** for mute, press **1** for low, press **2** for normal and press **3** for loud.

**Settings**
**Display Speed**

The scroll speed of the display can be changed.

- 1** Press the **Settings** button six times.

- 2** Press 1 for Slowest  
2 for Slow  
3 for Normal  
4 for Fast  
5 for Fastest

**Vent Fan**
**Vent Fan**

The vent fan removes steam and other vapors from surface cooking.

Press **VENT FAN** once for boost fan speed, twice for high fan speed, three times for medium fan speed, four times for low fan speed or five time to turn the fan off.

**NOTE:** The **FAN** indicator will be lit while the fan is operating.

During any microwaving cycle, the vent fan will only operate on the Low or Medium settings.

**Automatic Fan**

An automatic fan feature protects the microwave from too much heat rising from the cooktop below it. It automatically turns on if it senses too much heat.

If you have turned the fan on you may find that you cannot turn it off. The fan will automatically turn off when the internal parts are cool. It may stay on for 30 minutes or more after the cooktop and microwave controls are turned off.

**Settings**
**Auto Night Light**

The **Auto Night Light** can be set to come on and go off at desired times.

- 1** Press the **Settings** button four times.
- 2** Press 0 to turn off the Auto Night Light or press 1 to set the Auto Night Light or press 2 to review the Auto Night Light settings.
- 3** If setting Auto Night Light, enter a valid time of day for the Auto Night Light to turn ON.

- 4** Select AM or PM for ON time.
- 5** Enter a valid time of day for the Auto Night Light to turn it OFF.
- 6** Select AM or PM for OFF time.
- 7** Press **Settings** to confirm the settings entered.

**Settings**
**Display Language**

Use to select to displayed language.

- 1** Press the **Settings** button seven times.
- 2** Press **1** for English and press **2** for Spanish..

## Care and cleaning of the oven.

---



### **Helpful Hints**

An occasional thorough wiping with a solution of baking soda and water keeps the inside fresh. *Be sure the power is off before cleaning any part of this oven.*

---

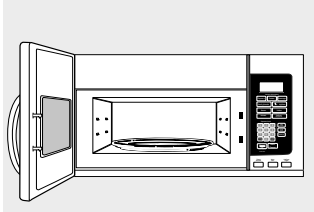

### **How to Clean the Inside**

#### **Walls, Floor, Inside Window, Metal and Plastic Parts on the Door**

Some spatters can be removed with a paper towel; others may require a damp cloth. Remove greasy spatters with a sudsy cloth, then rinse with a damp cloth. Do not use abrasive cleaners or sharp utensils on oven walls.

*Never use a commercial oven cleaner on any part of your microwave.*

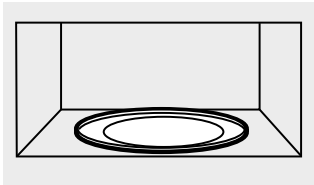

#### **Removable Turntable and Turntable Support**

To prevent breakage, do not place the turntable into water just after cooking. Wash it carefully in warm, sudsy water or in the dishwasher. The turntable and support can be broken if dropped. Remember, do not operate the oven in the microwave mode without the turntable and support seated and in place.



#### **Shelves**

Clean with mild soap and water or in the dishwasher.

**Do not clean in a self-cleaning oven.**

---

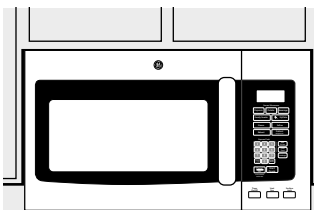

### **How to Clean the Outside**

*We recommend against using cleaners with ammonia or alcohol, as they can damage the appearance of the microwave oven. If you choose to use a common household cleaner, first apply the cleaner directly to a clean cloth, then wipe the soiled area.*

#### **Case**

Clean the outside of the microwave with a sudsy cloth. Rinse and then dry. Wipe the window clean with a damp cloth.

#### **Control Panel**

Wipe with a damp cloth. Dry thoroughly. Do not use cleaning sprays, large amounts of soap and water, abrasives or sharp objects on the panel—they can damage it. Some paper towels can also scratch the control panel.

#### **Door Panel**

Before cleaning the front door panel, make sure you know what type of panel you have. Refer to the eighth digit of the model number. "S" is stainless steel, "E" is slate gray, and "B", "W" or "C" are plastic colors.

#### **Stainless Steel (on some models)**

The stainless steel panel can be cleaned with Stainless Steel Magic or a similar product using a clean, soft cloth. Apply stainless cleaner carefully to avoid the surrounding plastic parts. Do not use appliance wax, polish, bleach or products containing chlorine on Stainless Steel finishes.

#### **Plastic Color Panels**

Use a clean, soft, lightly dampened cloth, then dry thoroughly.

#### **Door Seal**

It's important to keep the area clean where the door seals against the microwave. Use only mild, non-abrasive detergents applied with a clean sponge or soft cloth. Rinse well.

#### **Bottom**

Clean off the grease and dust on the bottom often. Use a solution of warm water and detergent.

# Shelf (on some models).



**NOTE:** Only use the shelf when reheating on more than one level. **DO NOT** store the oven shelf in the microwave.

## **! WARNING ARCING:**

If you see arcing, press the **Cancel/Off** button and correct the problem.

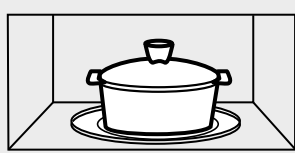

For best results

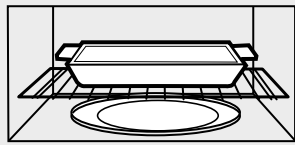

Uneven results



Uneven results

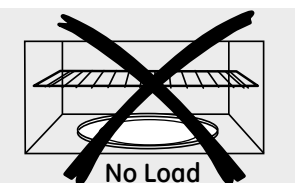

No Load



## Shelf (on some models)

Only use microwave shelf when reheating on more than one level. **DO NOT** store the oven shelf in the microwave.

### How to Use the Shelf When Microwaving:

- Make sure the shelf is positioned properly inside the microwave to prevent damage to the oven from arcing.
- Do not use a microwave browning dish on the shelf. The shelf could overheat.
- Do not use the oven with the shelf on the microwave floor. This could damage the microwave.
- Use pot holders when handling the shelf - it may be hot.
- Do not use the shelf when cooking popcorn.
- Do not use the shelf with Sensor Cooking or Reheat.

Food microwaves best when placed on the turntable or on the shelf in the lower position.

Use lower shelf supports when cooking one oblong or oversized dish.

Use the upper shelf supports for two-level cooking.

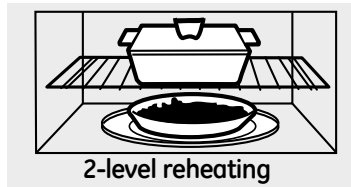

2-level reheating

## Shelf and Reheating

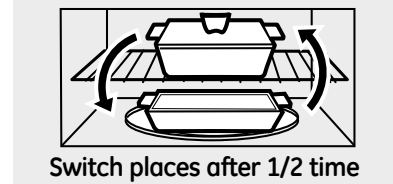

Switch places after 1/2 time

To reheat on 2 levels or

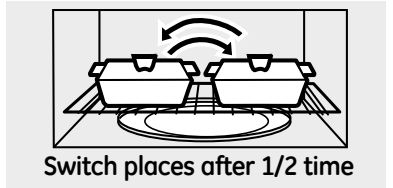

Switch places after 1/2 time

To reheat 2 dishes on the lower level:

- 1 Multiply reheat time by 1 1/2.

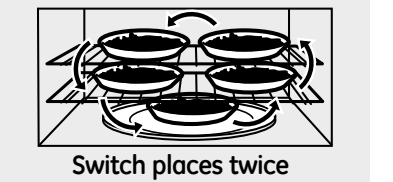

Switch places twice

- 2 Switch places after 1/2 the time.

To reheat on 3 levels (on some models)

- 1 Double the reheating time.
- 2 Switch places twice and give the dishes a 1/2 turn during reheating. (Place dense foods, or those that require a longer cook time, on the upper shelf first.)

## Replacing the light bulb.

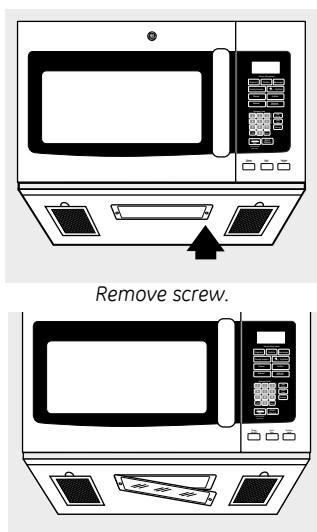

### Cooktop Light/Night Light

Replace with a 120 volt, 25 or 50 watt (max.) halogen bulb. Order WB36X10213 from your GE supplier.

- 1 To replace the cooktop light/night light, first disconnect the power at the main fuse or circuit breaker panel, or pull the plug.
- 2 Remove the screw from the side of the light compartment cover and lower the cover until it stops.
- 3 Be sure the bulb is cool before removing. Break the adhesive seal by gently unscrewing the bulb.
- 4 Screw in the new bulb, then raise the light cover and replace the screw. Connect electrical power to the oven.

## About the exhaust feature.

Charcoal filter (on some models).

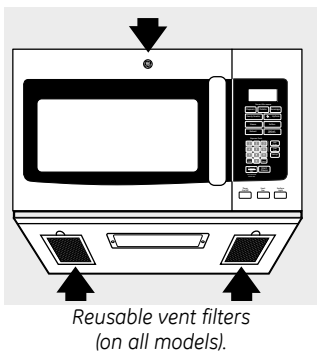

### Vent Fan

The vent fan has two metal reusable vent filters.

Models that recirculate air back into the room also use a charcoal filter.

### Reusable Vent Filters

The metal filters trap grease released by foods on the cooktop. They also prevent flames from foods on the cooktop from damaging the inside of the oven.

For this reason, the filters must always be in place when the hood is used. The vent filters should be cleaned once a month, or as needed.

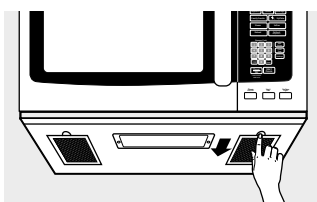

### Removing and Cleaning the Filters

**To remove**, slide them to the rear using the tabs. Pull down and out.

To clean the vent filters, soak them and then swish around in hot water and detergent. Don't use ammonia or ammonia products because they will darken the metal. Light brushing can be used to remove embedded dirt.

Rinse, shake and let dry before replacing.

**To replace**, slide the filters into the frame slots on the back of each opening. Press up and to the front to lock into place.

## Charcoal Filter

Sales No. JX81H

Service No. WB02X10956

**The charcoal filter cannot be cleaned. It must be replaced. Order Part No. WB02X10956 from your GE supplier.**

If the model is not vented to the outside, the air will be recirculated through a disposable charcoal filter that helps remove smoke and odors.

The charcoal filter should be replaced when it is noticeably dirty or discolored (usually after 6 to 12 months, depending on usage). See "Optional Kits," page 10, for more information.

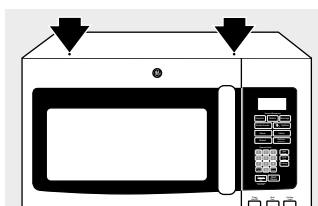

Remove 2 grille screws to remove the grille.

## To Remove the Charcoal Filter

**To remove the charcoal filter**, first disconnect power at the main fuse or circuit breaker, or pull the plug. Remove the top grille by removing the two screws that hold it in place.

You may need to open the cabinet doors to remove the screws.

Lift the filter at the bottom until it comes free of the tabs. Slide the filter down and out.

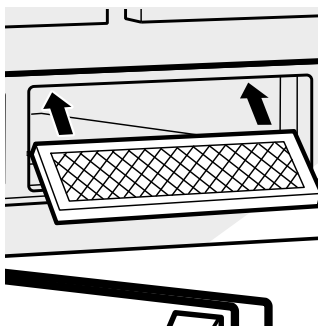
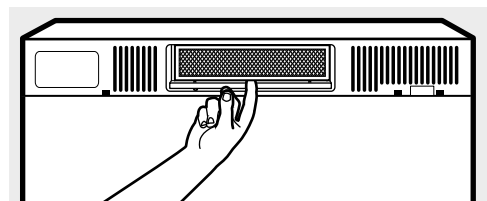

## To Install the Charcoal Filter

**To install a new charcoal filter**, remove plastic and other outer wrapping from the new filter.

Insert the top of the filter up and into the grooves on the inside of the top opening. Push the bottom of the filter in until it rests in place behind the tabs.

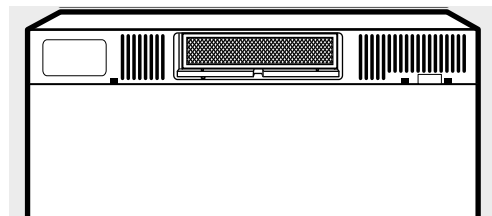

## ***Before you call for service...***

---

### ***Things That Are Normal With Your Microwave Oven***

- Moisture on the oven door and walls while cooking. Wipe the moisture off with a paper towel or soft cloth.
- Moisture between the oven door panels when cooking certain foods. Moisture should dissipate shortly after cooking is finished.
- Steam or vapor escaping from around the door.
- Light reflection around door or outer case.
- Dimming oven light and change in the blower sound at power levels other than high.
- Dull thumping sound while oven is operating.
- TV-radio interference might be noticed while using the microwave. Similar to the interference caused by other small appliances, it does not indicate a problem with the microwave. Plug the microwave into a different electrical circuit, move the radio or TV as far away from the microwave as possible or check the position and signal of the TV/radio antenna.

NOTE: If your display is off check to see if your Power Saver feature/Zero Standby button is engaged.

# Before you call for service...



**Troubleshooting Tips**  
Save time and money! Review the charts on the following pages first and you may not need to call for service.

<b>Problem</b>	<b>Possible Causes</b>	<b>What To Do</b>
<b>Oven will not start</b>	A fuse in your home may be blown or the circuit breaker tripped.	<ul style="list-style-type: none"> <li>• Replace fuse or reset circuit breaker.</li> </ul>
	Power surge.	<ul style="list-style-type: none"> <li>• Unplug the microwave oven, then plug it back in.</li> </ul>
	Plug not fully inserted into wall outlet.	<ul style="list-style-type: none"> <li>• Make sure the 3-prong plug on the oven is fully inserted into wall outlet.</li> </ul>
	Door not securely closed.	<ul style="list-style-type: none"> <li>• Open the door and close securely.</li> </ul>
	Power Saver button not engaged.	<ul style="list-style-type: none"> <li>• Push the <b>Power Saver</b> button so it is pressed in.</li> </ul>
<b>Control panel lighted, yet oven will not start</b>	Door not securely closed.	<ul style="list-style-type: none"> <li>• Open the door and close securely.</li> </ul>
	Start/Pause button not pressed after entering cooking selection.	<ul style="list-style-type: none"> <li>• Press <b>Start/Pause</b>.</li> </ul>
	Another selection entered already in oven and Cancel/Off button not pressed to cancel it.	<ul style="list-style-type: none"> <li>• Press <b>Cancel/Off</b>.</li> </ul>
	Cooking time not entered after pressing Time Cook.	<ul style="list-style-type: none"> <li>• Make sure you have entered cooking time after pressing <b>Cook Time</b>.</li> </ul>
	Cancel/Off was pressed accidentally.	<ul style="list-style-type: none"> <li>• Reset cooking program and press <b>Start/Pause</b>.</li> </ul>
	Food weight not entered after selecting AUTO DEFROST or 1lb Quick DEFROST.	<ul style="list-style-type: none"> <li>• Make sure you have entered food weight after selecting <b>AUTO DEFROST</b> or <b>FAST DEFROST</b>.</li> </ul>
Food type not entered after pressing AUTO COOK.	<ul style="list-style-type: none"> <li>• Make sure you have entered a food type.</li> </ul>	
<b>CONTROL LOCKED</b> appears on display	The control has been locked.	<ul style="list-style-type: none"> <li>• Press and hold <b>Cancel/Off</b> for about 3 seconds to unlock the control.</li> </ul>
<b>Floor of the oven is warm even when the oven has not been used</b>	The cooktop light is located below the oven floor. When light is on, the heat it produces may make the oven floor get warm.	<ul style="list-style-type: none"> <li>• This is normal.</li> </ul>
<b>You hear an unusual low-tone beep</b>	You have tried to change the power level when it is not allowed.	<ul style="list-style-type: none"> <li>• Many of the oven's features are preset and cannot be changed.</li> </ul>

## Before you call for service...

---

<b>Problem</b>	<b>Possible Causes</b>	<b>What To Do</b>
<b>Vent fan comes on automatically</b>	The vent fan automatically turns on to protect the microwave if it senses too much heat rising from the cooktop below.	<ul style="list-style-type: none"><li>• This is normal.</li></ul>
<b>SENSOR ERROR appears on the display</b>	When using a Sensor feature, the door was opened before steam could be detected.	<ul style="list-style-type: none"><li>• Do not open door until steam is sensed and time is shown counting down on the display.</li></ul>
	Steam was not detected in a maximum amount of time.	<ul style="list-style-type: none"><li>• Use COOK TIME to heat for more time.</li></ul>



---

Please place in envelope and mail to:  
Veuillez mettre dans une enveloppe et envoyez à :

**OWNERSHIP REGISTRATION  
P.O. BOX 1780  
MISSISSAUGA, ONTARIO  
L4Y 4G1**

**(FOR CANADIAN CONSUMERS ONLY -  
POUR RÉSIDENTS CANADIENS SEULEMENT)**

---



For Canadian  
Customers



Pour les  
consommateurs  
canadiens

CUT ALONG THIS LINE AND RETURN CARD - THANKS  
DÉCOUPEZ ICI ET ENVOYEZ LA FICHE - MERCI

### OWNERSHIP REGISTRATION CERTIFICATE – FICHE D'INSCRIPTION DU PROPRIÉTAIRE

Please register your product to enable us to contact you in the remote event a safety notice is issued for this product and to allow for efficient communication under the terms of our warranty, should the need arise.

Veillez enregistrer votre produit afin de nous permettre de communiquer avec vous si jamais un avis de sécurité concernant ce produit était émis et de communiquer facilement avec vous en vertu de votre garantie, si le besoin s'en fait sentir.

REGISTER ON-LINE: ENREGISTREMENT SUR INTERNET À :		<b>www.geappliances.ca</b>		MAIL TO: POSTEZ À :		<b>P.O. BOX 1780, MISSISSAUGA</b>	
		<b>www.electromenagersge.ca</b>				<b>ONTARIO, L4Y 4G1</b>	
<input type="checkbox"/> MR. / M.	<input type="checkbox"/> MRS. / MME	FIRST NAME / PRÉNOM		LAST NAME / NOM			
<input type="checkbox"/> MISS/MLE	<input type="checkbox"/> MS.						
STREET NO / N° RUE		STREET NAME / RUE				APT.NO/APP./RR#	
CITY / VILLE				PROVINCE		POSTAL CODE/CODE POSTAL	
AREA CODE/IND. RÉG.		TELEPHONE/TÉLÉPHONE		E-MAIL/COURRIEL			
DID YOU PURCHASE A SERVICE CONTRACT FOR THIS APPLIANCE? AVEZ-VOUS ACHETÉ UN CONTRAT DE SERVICE POUR CET APPAREIL ?				YES/OUI		<input type="checkbox"/> IF YES/SI OUI : EXPIRATION	
				NO/NON		Y/A M DJ	
NAME OF SELLING DEALER / NOM DU MARCHAND				MODEL / MODÈLE			
INSTALLATION DATE / DATE D'INSTALLATION		CORRESPONDENCE		<input type="checkbox"/> ENGLISH			
Y/A M DJ		CORRESPONDANCE		<input type="checkbox"/> FRANÇAIS		SERIAL / SÉRIE	
<input type="checkbox"/> I do not wish to receive any promotional offers regarding this product. Je ne désire pas recevoir d'offres promotionnelles concernant ce produit.							

# GE Microwave Oven Warranty.



All warranty service provided by our Factory Service Centers, or an authorized Customer Care® technician. To schedule service, online, contact us at [GEAppliances.ca](http://GEAppliances.ca), or call 1.800.561.3344. Please have serial and model numbers available when calling for service.

Staple your receipt here. Proof of the original purchase date is needed to obtain service under the warranty.

For The Period Of:	Mabe Will Replace:
<b>One Year</b> <i>From the date of the original purchase</i>	<b>Any part</b> of the oven which fails due to a defect in materials or workmanship. During this <b>limited one-year warranty</b> , Mabe will also provide, <b>free of charge</b> , all labor and related service costs to replace the defective part.
<b>Five Years</b> <i>From the date of the original purchase</i>	The magnetron tube, if the magnetron tube fails due to a defect in materials or workmanship. During this five-year limited warranty, you will be responsible for any labor or in-home service costs.

## What Mabe Will Not Cover:

- Service trips to your home to teach you how to use the product.
- Improper installation, delivery or maintenance.
- Product not accessible to provide required service.
- Failure of the product or damage to the product if it is abused, misused (for example, cavity arcing from wire rack or metal/foil), or used for other than the intended purpose or used commercially.
- Replacement of house fuses or resetting of circuit breakers.
- Replacement of the cooktop light bulbs.
- Damage to the product caused by accident, fire, floods or acts of God.
- Incidental or consequential damage caused by possible defects with this appliance.
- Damage caused after delivery.

**EXCLUSION OF IMPLIED WARRANTIES—Your sole and exclusive remedy is product exchange as provided in this Limited Warranty. Any implied warranties, including the implied warranties of merchantability or fitness for a particular purpose, are limited to one year or the shortest period allowed by law.**

This warranty is extended to the original purchaser and any succeeding owner for products purchased for home use within Canada. If the product is located in an area where service by a Mabe Canada Authorized Servicer is not available, you may be responsible for a trip charge or you may be required to bring the product to an Authorized Mabe Canada Service Location for service.

Some provinces do not allow the exclusion or limitation of incidental or consequential damages. This warranty gives you specific legal rights, and you may also have other rights which vary from province to province. To know what your legal rights are, consult your local or provincial consumer affairs office.

Exclusion of implied warranties: Except where prohibited or restricted by law, there are no warranties, whether express, oral or statutory which extend beyond the description on the face hereof, including specifically the implied warranties of merchantability or fitness for a particular purpose.

**Warrantor: Mabe Canada Inc., Burlington, Ontario**

## Consumer Support.

---



### GE Appliances Website

**GEAppliances.ca**

Have a question or need assistance with your appliance? Try the GE Appliances Website 24 hours a day, any day of the year! For greater convenience and faster service, you can now download Owner's Manuals, order parts, catalogs.

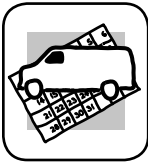

### Schedule Service

**GEAppliances.ca**

Expert Mabe repair service is only one step away from your door. Get on-line and schedule your service at your convenience any day of the year! Or call 1.800.561.3344 during normal business hours.



### Service Contracts

**GEAppliances.ca**

Purchase a Mabe extended warranty and learn about special discounts that are available while your warranty is still in effect. You can purchase it on-line anytime, or call 1.800.461.3636 during normal business hours. Mabe Consumer Home Services will still be there after your warranty expires.

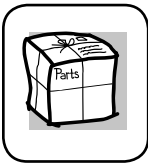

### Parts and Accessories

**GEAppliances.ca**

Individuals qualified to service their own appliances can have parts or accessories sent directly to their homes (VISA, MasterCard and Discover cards are accepted). Order on-line today, 24 hours every day or by phone at 1.800.661.1616 during normal business hours.

***Instructions contained in this manual cover procedures to be performed by any user. Other servicing generally should be referred to qualified service personnel. Caution must be exercised, since improper servicing may cause unsafe operation.***



### Contact Us

**GEAppliances.ca**

If you are not satisfied with the service you receive from Mabe, contact us on our Website with all the details including your phone number, or write to:

General Manager, Customer Relations  
Mabe Canada Inc,  
Suite 310, 1 Factory Lane,  
Moncton NB E1C 9M3



### Register Your Appliance

**GEAppliances.ca**

**Register your new appliance on-line—at your convenience!** Timely product registration will allow for enhanced communication and prompt service under the terms of your warranty, should the need arise. You may also mail in the pre-printed registration card included in the packing material.