



# Microwave Oven

**Safety Instructions** ..... 2-8

**Operating Instructions**

Oven Features ..... 9  
Controls ..... 10  
Time Features..... 11  
Defrost Features ..... 12-14  
Convenience Features..... 15, 16  
Microwave Terms ..... 16  
Power Levels..... 17  
Other Features..... 18-20  
Replacing the Light Bulb..... 23  
Exhaust Features..... 23

**Care and Cleaning**..... 24, 25

**Troubleshooting Tips**

Before you call for service ..... 25, 26

**Consumer Support**

Optional Kits ..... 8  
Product Registration ..... 27  
Warranty ..... 29  
Consumer Support..... 30

**Owner's Manual**

JVM1630WFC  
JVM1630BFC  
JVM1635SFC

*Write the model and serial numbers here:*

**Model #** \_\_\_\_\_

**Serial #** \_\_\_\_\_

You can find them on a label when the door is open.

# IMPORTANT SAFETY INSTRUCTIONS.

## READ ALL INSTRUCTIONS BEFORE USING.

---

When using electrical appliances basic safety precautions should be followed, including the following:

### **⚠ WARNING!**

To reduce the risk of burns, electric shock, fire, injury to persons or exposure to excessive microwave energy:

### **PRECAUTIONS TO AVOID POSSIBLE EXPOSURE TO EXCESSIVE MICROWAVE ENERGY**

- (a) **Do Not Attempt** to operate this oven with the door open since open-door operation can result in harmful exposure to microwave energy. It is important not to defeat or tamper with the safety interlocks.
- (b) **Do Not Place** any object between the oven front face and the door or allow soil or cleaner residue to accumulate on sealing surfaces.
- (c) **Do Not Operate** the oven if it is damaged. It is particularly important that the oven door close properly and that there is no damage to the:
  - (1) door (bent)
  - (2) hinges and latches (broken or loosened)
  - (3) door seals and sealing surfaces
- (d) **The Oven Should Not** be adjusted or repaired by anyone except properly qualified service personnel.

- **Read all instructions before using this appliance. When using electrical appliances, basic safety precautions should be followed, including the following:**
  - Read and follow the specific precautions in the Precautions to Avoid Possible Exposure to Excessive Microwave Energy section above.
  - This appliance must be grounded. Connect only to a properly grounded outlet. See the Grounding Instructions section on page 7.
  - This microwave oven is cUL listed for installation over both gas (less than 60,000BTU) and electric ranges.
  - This over-the-range oven is designed for use over ranges no wider than 36" (91.4 cm). It may be installed over both gas and electric cooking equipment.
- Do not operate this appliance if it has a damaged power cord or plug, if it is not working properly, or if it has been damaged or dropped. If the power cord is damaged, it must be replaced by General Electric Service or an authorized service agent using a power cord available from General Electric.
- Install or locate this appliance only in accordance with the provided installation instructions.
- Do not clean with metal scouring pads. Pieces can burn off the pad and touch electrical parts involving risk of electric shock.

## SAVE THESE INSTRUCTIONS

*Use this appliance only for its intended purpose as described in this Owner's Manual.*

- To reduce the risk of fire in the oven cavity:
  - Do not overcook food. Carefully attend appliance when paper, plastic or other combustible materials are placed inside the oven while cooking.
  - Remove wire twist-ties and metal handles from paper or plastic containers before placing them in the oven.
  - Do not use the oven for storage purposes. Do not leave paper products, cooking utensils or food in the oven when not in use.
  - Do not pop popcorn in your microwave oven unless in a special microwave popcorn accessory or unless you use popcorn labeled for use in microwave ovens.
  - If materials inside the oven ignite, keep the oven door closed, turn the oven off and disconnect the power cord, or shut off power at the fuse or circuit breaker panel. If the door is opened, the fire may spread.
  - Do not use the oven to dry newspaper.
- **Thermometer**—Do not use regular cooking or oven thermometers when cooking by microwave. The metal and mercury in these thermometers could cause **arcing** and possible damage to the oven. Do not use a thermometer in food you are microwaving unless the thermometer is designed or recommended for use in the microwave oven.
- Do not store any materials, other than our recommended accessories, in this oven when not in use.
- Do not store this appliance outdoors. Do not use this product near water—for example, in a wet basement, near a swimming pool, near a sink or in similar locations.
- Keep power cord away from heated surfaces.
- Do not immerse power cord or plug in water.
- Do not block or cover any openings on the appliance.
- This microwave is not approved or tested for marine use.
- Use this appliance only for its intended use as described in this manual.
- Do not use corrosive chemicals or vapors in this appliance.
- This microwave oven is specifically designed to heat, dry or cook food, and is not intended for laboratory or industrial use.
- Some products such as whole eggs and sealed containers—for example, closed jars—are able to explode and should not be heated in this microwave oven. Such use of the microwave oven could result in injury.
- It is important to keep the area clean where the door seals against the microwave. Use only mild, non-abrasive detergents applied with a clean sponge or soft cloth. Rinse well.
- This appliance must only be serviced by qualified service personnel. Contact nearest authorized service facility for examination, repair or adjustment.
- As with any appliance, close supervision is necessary when used by children.
- Do not store anything directly on top of the microwave oven surface when the microwave oven is in operation.
- Do not mount this appliance over a sink.
- Do not let the cord hang over edge of counter.
- Do not use paper products in oven when appliance is operated in any cooking mode except microwave only.

**SAVE THESE INSTRUCTIONS**

# IMPORTANT SAFETY INSTRUCTIONS. READ ALL INSTRUCTIONS BEFORE USING.

---



## **⚠ WARNING!** **ARCING**

---

If you see arcing, press the **CANCEL/OFF** button and correct the problem.

*Arcing is the microwave term for sparks in the oven. Arcing is caused by:*

- Metal or foil touching the side of the oven.
- Turntable ring support not installed correctly.
- Foil not molded to food (upturned edges act like antennas).
- Metal, such as twist-ties, poultry pins, or gold-rimmed dishes, in the microwave.
- Recycled paper towels containing small metal pieces being used in the microwave.



## ▲ WARNING! FOOD

- Do not pop popcorn in your microwave oven unless in a special microwave popcorn accessory or unless you use popcorn labeled for use in microwave ovens.
  - Do not boil eggs in a microwave oven. Pressure will build up inside egg yolk and will cause it to burst, possibly resulting in injury.
  - Operating the microwave with no food inside for more than a minute or two may cause damage to the oven and could start a fire. It increases the heat around the magnetron and can shorten the life of the oven.
  - Foods with unbroken outer “skin” such as potatoes, hot dogs, sausages, tomatoes, apples, chicken livers and other giblets, and egg yolks should be pierced to allow steam to escape during cooking.
  - **SUPERHEATED WATER**  
*Liquids, such as water, coffee, or tea, are able to be overheated beyond the boiling point without appearing to be boiling. Visible bubbling or boiling when the container is removed from the microwave oven is not always present. THIS COULD RESULT IN VERY HOT LIQUIDS SUDDENLY BOILING OVER WHEN THE CONTAINER IS DISTURBED OR A SPOON OR OTHER UTENSIL IS INSERTED INTO THE LIQUID.*
- To reduce the risk of injury to persons:
- Do not overheat the liquid.
  - Stir the liquid both before and halfway through heating it.
  - Do not use straight-sided containers with narrow necks.
  - After heating, allow the container to stand in the microwave oven for a short time before removing the container.
  - Use extreme care when inserting a spoon or other utensil into the container.
- Foods cooked in liquids (such as pasta) may tend to boil more rapidly than foods containing less moisture. Should this occur, refer to the Care and Cleaning of the Microwave Oven section for instructions on how to clean the inside of the oven.
  - Avoid heating baby food in glass jars, even with the lid off. Make sure all infant food is thoroughly cooked. Stir food to distribute the heat evenly. Be careful to prevent scalding when warming formula. The container may feel cooler than the formula really is. Always test the formula before feeding the baby.
  - Don't defrost frozen beverages in narrow-necked bottles (especially carbonated beverages). Even if the container is opened, pressure can build up. This can cause the container to burst, possibly resulting in injury.
  - Hot foods and steam can cause burns. Be careful when opening any containers of hot food, including popcorn bags, cooking pouches and boxes. To prevent possible injury, direct steam away from hands and face.
  - Do not overcook potatoes. They could dehydrate and catch fire, causing damage to your oven.
  - Cook meat and poultry thoroughly—meat to at least an INTERNAL temperature of 160°F (71°C) and poultry to at least an INTERNAL temperature of 180°F (82°C). Cooking to these temperatures usually protects against foodborne illness.

## SAVE THESE INSTRUCTIONS

# IMPORTANT SAFETY INSTRUCTIONS.

## READ ALL INSTRUCTIONS BEFORE USING.



### MICROWAVE-SAFE COOKWARE

Do not operate the oven in the microwave mode without the turntable and the turntable support seated and in place. The turntable must be unrestricted so it can rotate. *Make sure all cookware used in your microwave oven is suitable for microwaving. Most glass casseroles, cooking dishes, measuring cups, custard cups, pottery or china dinnerware which does not have metallic trim or glaze with a metallic sheen can be used. Some cookware is labeled "suitable for microwaving."*

- If you are not sure if a dish is microwave-safe, use this test: Place in the oven both the dish you are testing and a glass measuring cup filled with 1 cup (240 mL) of water—set the measuring cup either in or next to the dish. Microwave 30–45 seconds at high. If the dish heats, it should not be used for microwaving.



*How to test for a microwave-safe dish.*

If the dish remains cool and only the water in the cup heats, then the dish is microwave-safe.

- Oversized food or oversized metal cookware should not be used in a microwave/convection oven because they increase the risk of electric shock and could cause a fire.
- Sometimes the oven floor, turntable and walls can become too hot to touch. Be careful touching the floor, turntable and walls during and after cooking.
- If you use a meat thermometer while microwaving, make sure it is safe for use in microwave ovens.
- Do not use recycled paper products. Recycled paper towels, napkins and waxed paper can contain metal flecks which may cause arcing or ignite. Paper products containing nylon or nylon filaments should be avoided, as they may also ignite.
- Some foam trays (like those that meat is packaged on) have a thin strip of metal embedded in the bottom. When microwaved, the metal can burn the floor of the oven or ignite a paper towel.
- Do not use your microwave oven to dry newspapers.
- Not all plastic wrap is suitable for use in microwave ovens. Check the package for proper use.
- Paper towels, waxed paper and plastic wrap can be used to cover dishes in order to retain moisture and prevent spattering while microwaving. Be sure to vent plastic wrap so steam can escape.
- Cookware may become hot because of heat transferred from the heated food. Pot holders may be needed to handle the cookware.
- When microwaving "boilable" cooking pouches and tightly closed plastic bags, they should be slit, pierced or vented as directed by package. If they are not, plastic could burst during or immediately after cooking, possibly resulting in injury. Also, plastic storage containers should be at least partially uncovered because they form a tight seal. When cooking with containers tightly covered with plastic wrap, remove covering carefully and direct steam away from hands and face.



## MICROWAVE-SAFE COOKWARE (cont.)

- Use foil only as directed in this manual. When using foil in the microwave oven, keep the foil at least 1" (2.5 cm) away from the sides of the oven.
- Plastic cookware designed for microwave cooking is very useful, but should be used carefully. Even microwave-safe plastic may not be as tolerant of overcooking conditions as are glass or ceramic materials and may soften or char if subjected to short periods of overcooking. In longer exposures to overcooking, the food and cookware could ignite.

Follow these guidelines:

- 1** Use microwave-safe plastics only and use them in strict compliance with the cookware manufacturer's recommendations.
- 2** Do not microwave empty containers.
- 3** Do not permit children to use plastic cookware without complete supervision.

## **⚠ WARNING!** GROUNDING INSTRUCTIONS

### **WARNING!**

*Improper use of the grounding plug can result in a risk of electric shock.*

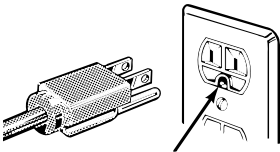

Ensure proper ground exists before use.

This appliance must be grounded. In the event of an electrical short circuit, grounding reduces the risk of electric

shock by providing an escape wire for the electric current.

This appliance is equipped with a power cord having a grounding wire with a grounding plug. The plug must be plugged into an outlet that is properly installed and grounded.

Consult a qualified electrician or service technician if the grounding instructions are not completely understood, or if doubt exists as to whether the appliance is properly grounded.

If the outlet is a standard 2-prong wall outlet, it is your personal responsibility and obligation to have it replaced with a properly grounded 3-prong wall outlet.

Do not under any circumstances cut or remove the third (ground) prong from the power cord.

Do not use an adapter plug with this appliance.

Do not use an extension cord with this appliance. If the power cord is too short, have a qualified electrician or service technician install an outlet near the appliance.

For best operation, plug this appliance into its own electrical outlet to prevent flickering of lights, blowing of fuse or tripping of circuit breaker.

## SAVE THESE INSTRUCTIONS

# IMPORTANT SAFETY INSTRUCTIONS.

## READ ALL INSTRUCTIONS BEFORE USING.

---

### THE VENT FAN

---

The fan will operate automatically under certain conditions (see Automatic Fan feature). Take care to prevent the starting and spreading of accidental cooking fires while the vent fan is in use.

- Clean the underside of the microwave often. Do not allow grease to build up on the microwave or the fan filters.
- In the event of a grease fire on the surface units below the microwave oven, smother a flaming pan on the surface unit by covering the pan completely with a lid, a cookie sheet or a flat tray.

- Use care when cleaning the vent fan filters. Corrosive cleaning agents, such as lye-based oven cleaners, may damage the filters.
- When preparing flaming foods under the microwave, turn the fan on.
- Never leave surface units beneath your microwave oven unattended at high heat settings. Boilovers cause smoking and greasy spillovers that may ignite and spread if the microwave vent fan is operating. To minimize automatic fan operation, use adequate sized cookware and use high heat on surface units only when necessary.

### PACEMAKERS

---

Most pacemakers are shielded from interference from electronic products, including microwaves. However, patients with pacemakers may wish to consult their physicians if they have concerns.

### OPTIONAL KITS

---

Available at extra cost from your GE supplier.

#### Filler Panel Kits

- JX48WH—White
- JX46BL—Black

When replacing a 36" (91.4 cm) range hood, filler panel kits fill in the additional width to provide a custom built-in appearance.

For installation between cabinets only; not for end-of-cabinet installation. Each kit contains two 3" (7.6 cm) wide filler panels.

#### Charcoal Filter Kits

- JX81L —Recirculating Charcoal Filter Kit

Filter kits are used when the oven cannot be vented to the outside.

See back cover to order by phone or at [GEAppliances.ca](http://GEAppliances.ca).

READ AND FOLLOW THIS SAFETY INFORMATION CAREFULLY.

---

## SAVE THESE INSTRUCTIONS



# About the features of your oven.

Throughout this manual, features and appearance may vary from your model.

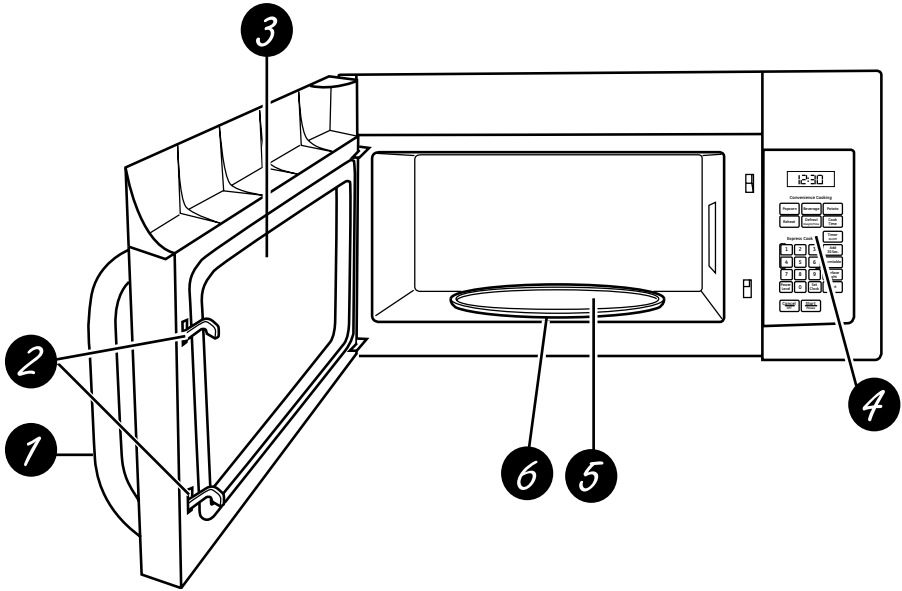

## Features of the Oven

- 1 Door Handle.**
- 2 Door Latches.**
- 3 Window with Metal Shield.** Screen allows cooking to be viewed while keeping microwaves confined in the oven.
- 4 Control Panel.**
- 5 Removable Turntable.** Do not operate the oven in the microwave mode without the turntable and turntable support seated and in place.
- 6 Removable Turntable Support.** Do not operate the oven in the microwave mode without the turntable and turntable support seated and in place.

# About the cooking features of your microwave oven.

Throughout this manual, features and appearance may vary from your model.

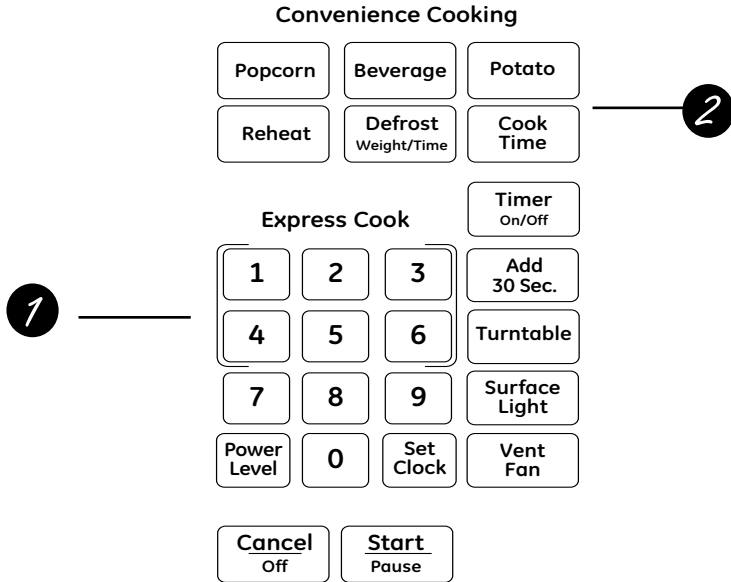

## Cooking Controls

Check the Convenience Guide before you begin.

### 1 Time Features

Press	Enter
COOK TIME	Amount of cooking time
DEFROST	Weight or time
TIMER	
POWER LEVEL	Power level 1 to 10
ADD 30 SEC	Starts immediately!
EXPRESS COOK	Starts immediately!

### 2 Convenience Features

Press	Enter
POPCORN	Press pad to select serving size
REHEAT	Press pad to select food
BEVERAGE	Press pad to select serving size
POTATO	Press pad to select serving size

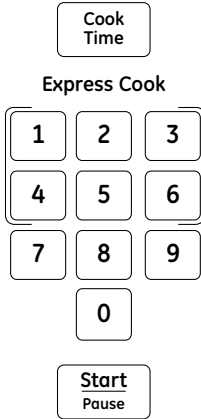

## Cook Time

Allows you to microwave for any time up to 99 minutes and 99 seconds.

**Power level 10 (HIGH)** is automatically set, but you may change it for more flexibility.

- 1 Press **Cook Time**.
- 2 Enter cooking time.
- 3 Press **START**.  
*Cooking will start when the countdown begins in the display.*

You may open the door during **Cook Time** to check the food. Close the door and press **START** to resume cooking.

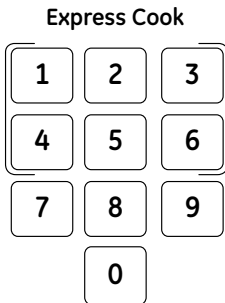

## Express Cook

*This is a quick way to set cooking time for 1-6 minutes.*

- 1 Press one of the **Express Cook** pads (from 1-6) for 1-6 minutes of cooking at **power level 10**.  
For example, press the **2** pad for 2 minutes of cooking time.

The power level can be changed as time is counting down. Press **POWER LEVEL** and enter 1-10.

**NOTE:** Express Cook function pertains to pads 1-6 only.



## Add 30 Sec

This will add 30 seconds to the time counting down each time the pad is pressed. Each touch will add 30 seconds, up to 99 minutes and 99 seconds.

**Add 30 sec** can also be used like an express 30 seconds button. The microwave oven will start immediately when pressed.

## About the defrost features.

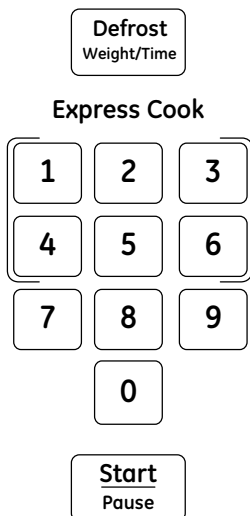

### Weight Defrost

Use **Weight Defrost** for meat, poultry and fish. Use **Time Defrost** for most other frozen foods. (Time Defrost is explained on page 13.)

- 1 Press **DEFROST** once for **Weight Defrost**.
- 2 Enter the weight in pounds.
- 3 Press **START**.  
*Cooking will start when the countdown begins in the display.*

### Defrosting Tips

- Remove meat from package and place on microwave-safe dish.
- When the oven signals, turn the food over. Remove defrosted meat or shield warm areas with small pieces of foil.
- After defrosting, most meats need to stand 5 minutes to complete defrosting. Large roasts should stand for about 30 minutes.

### Conversion Guide

If the weight of food is stated in pounds and ounces, the ounces must be converted to tenths (.1) of a pound.	
Ounces	Pounds
1-2 (28-57 g)	.1
3 (85 g)	.2
4-5 (113-142 g)	.3
6-7 (170-198 g)	.4
8 (227 g)	.5
9-10 (255 g)	.6
11 (312 g)	.7
12-13 (340-369 g)	.8
14-15 (397-425 g)	.9

Note: Max 6.0 lbs. (2.7 kg)

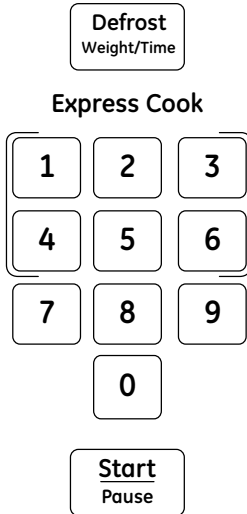

## Time Defrost

Allows you to defrost for a selected length of time. See the Defrosting Guide on page 14 for suggested times (**Weight Defrost** is explained on page 12).

- 1** Press **DEFROST** twice for **Time Defrost**.
- 2** Enter defrosting time in minutes and seconds.
- 3** Press **START**.  
*Cooking will start when the countdown begins in the display.*

At one half of selected defrosting time, turn food over and break apart or rearrange pieces for more even defrosting. Shield any warm areas with small pieces of foil. The oven will continue to defrost if you don't open the door and turn the food.

Noises may be heard during defrosting. This is normal when oven is not operating at **High** power.

## Defrosting Tips

- Foods frozen in paper or plastic can be defrosted in the package. Closed packages should be slit, pierced or vented **AFTER** food has partially defrosted. Plastic storage containers should be partially uncovered.
- Family-size, prepackaged frozen dinners can be defrosted and microwaved. If the food is in a foil container, transfer it to a microwave-safe dish.
- Foods that spoil easily should not be allowed to sit out for more than one hour after defrosting. Room temperature promotes the growth of harmful bacteria.
- For more even defrosting of larger foods, such as roasts, use **Time Defrost**. Be sure large meats are completely defrosted before cooking.
- When defrosted, food should be cool but softened in all areas. If still slightly icy, return to the microwave very briefly, or let it stand a few minutes.

# About the defrost features.

## Defrosting Guide

FOOD	TIME	COMMENTS
<b>Bread, Cakes</b> <i>Bread, buns, or rolls</i> (1 piece) <i>Sweet rolls</i> (approx. 12 oz/340g)	1/4 min. 2 to 4 min.	Rearrange after half the time
<b>Fish and Seafood</b> <i>Filletts, Frozen</i> (1 lb/454 g)	6 to 9 min.	
<b>Fruit</b> <i>Plastic Pouch - 1 or 2</i> (10 oz/284 g package)	1 to 5 min.	
<b>Meat</b> <i>Bacon</i> (1 lb/454 g)	2 to 5 min.	Place unopened package in oven. Let stand 5 minutes after defrosting.
<i>Franks</i> (1 lb/454 g)	2 to 5 min.	Place unopened package in oven. Microwave just until franks can be separated. Let stand 5 minutes, if necessary, to complete defrosting.
<i>Ground meat</i> (1 lb/454 g)	4 to 6 min.	Turn meat over after first half of time.
<i>Roast: beef, lamb, veal, pork</i>	9 to 13 min. per lb./454 g	Use power level 10.
<i>Steaks, chops and cutlets</i>	4 to 8 min. per lb./454 g	Place unwrapped meat in cooking dish. Turn over after first half of time and shield warm areas with foil. After second half of time, separate pieces with table knife. Let stand to complete defrosting.
<b>Poultry</b> <i>Chicken, broiler-fryer, cut up</i> (2½ to 3 lbs./1.1 to 1.4 kg)	14 to 20 min.	Place wrapped chicken in dish. Unwrap and turn over after first half of time. After second half of time, separate pieces and place in cooking dish. Microwave 2 to 4 minutes more, if necessary. Let stand a few minutes to finish defrosting.
<i>Chicken, whole</i> (2½ to 3 lbs./ 1.1 to 1.4 kg)	20 to 25 min.	Place wrapped chicken in dish. After half the time, unwrap and turn chicken over. Shield warm areas with foil. To complete defrosting, run cold water in the cavity until giblets can be removed.
<i>Ground meat</i> (1 lb/454 g)	7 to 13 min. per lb./454 g	Place unwrapped hen in the oven breast-side up. Turn over after first half of time. Run cool water in the cavity until giblets can be removed.
<i>Turkey breast</i> (4 to 6 lbs./ 1.8 to 2.7 kg)	3 to 8 min. per lb./454 g	Place unwrapped breast in microwave-safe dish breast-side down. After first half of time, turn breast-side up and shield warm areas with foil. Defrost for second half of time. Let stand 1 to 2 hours in refrigerator to complete defrosting.

## Popcorn

### Popcorn

To use the **Popcorn** feature:

- 1 Press the **POPCORN** button once for 2.0 oz. (57 g) bag, twice for 2.5 oz. (71 g) bag, or three times for a 3.0 oz. (85 g) bag.
- 2 Press **START**.

*Cooking will start when the countdown begins in the display.*

*You can not change the selection or quantity after the feature has started.*

If food is undercooked after the countdown, use **Cook Time** for additional cooking time. We recommend 30 seconds and watch carefully.

*Use only with prepackaged microwave popcorn weighing 2.0 to 3.0 ounces (57 to 85 g).*

**NOTE: Do not use this feature twice in succession on the same food portion—it may result in severely overcooked or burnt food.**

## Reheat

### Reheat

The **Reheat** feature reheats servings of previously cooked foods or a plate of leftovers.

Place the cup of liquid or covered food in the oven.

- 1 Press the **REHEAT** button up to six times to choose the correct selection.  
Press once for a pizza.  
Press twice for vegetables.  
Press three times for a plate of leftovers.  
Press four times for soup.  
Press five times for meat.  
Press six times for pasta.
- 2 Press the reheat pad again after food type has been entered in order to select quantity.
- 3 Press **START**.

*Cooking will start when the countdown begins in the display.*

*After removing food from the oven, stir, if possible, to even out the temperature. Reheated foods may have wide variations in temperature. Some areas of food may be extremely hot.*

If food is not hot enough after the countdown use **Cook Time** for additional reheating time.

#### **Some Foods Not Recommended for Use With Reheat**

It is best to use **Cook Time** for these foods:

- Bread products.
- Foods that must be reheated uncovered.
- Foods that need to be stirred or rotated.
- Foods calling for a dry look or crisp surface after reheating.

**NOTE: Do not use this feature twice in succession on the same food portion—it may result in severely overcooked or burnt food.**

# About the convenience features.

---

## Beverage

### Beverage

Use the **Beverage** feature to heat various amounts of liquids measured in ounces: Place the liquid into the microwave oven.

4 oz. (114 mL)	1/2 cup
8 oz. (227 mL)	1 cup
12 oz. (341 mL)	1-1/2 cups
16 oz. (455 mL)	2 cups

- 1 Press the **Beverage** button up to four times to choose the correct selection.  
Press once for a 4 ounce (114 mL) beverage.  
Press twice for a 8 ounce (227 mL) beverage.  
Press three times for a 12 ounce (341 mL) beverage.  
Press four times for a 16 ounce (455 mL) beverage.

- 2 Press **START**.  
*Cooking will start when the countdown begins in the display.*

## Potato

### Potato

To use the **Potato** feature:  
Place the potato(es) into the oven.

- 1 Press the **Potato** button up to four times to choose the correct selection.  
Press once for 1 item.  
Press twice for 2 items.  
Press three times for 3 items.  
Press four times for 4 items.

- 2 Press **START**.  
*Cooking will start when the countdown begins in the display.*

**NOTE: Do not use this feature twice in succession on the same food portion. It may result in severely overcooked or burnt food.**

# Microwave terms.

---

Term	Definition
<b>Arcing</b>	Arcing is the microwave term for sparks in the oven. Arcing is caused by: <ul style="list-style-type: none"><li>• metal or foil touching the side of the oven.</li><li>• foil that is not molded to food (upturned edges act like antennas).</li><li>• metal such as twist-ties, poultry pins, gold-rimmed dishes.</li><li>• recycled paper towels containing small metal pieces.</li></ul>
<b>Covering</b>	Covers hold in moisture, allow for more even heating and reduce cooking time. Venting plastic wrap or covering with wax paper allows excess steam to escape.
<b>Shielding</b>	In a regular oven, you shield chicken breasts or baked foods to prevent over-browning. When microwaving, you use small strips of foil to shield thin parts, such as the tips of wings and legs on poultry, which would cook before larger parts.
<b>Standing Time</b>	When you cook with regular ovens, foods such as roasts or cakes are allowed to stand to finish cooking or to set. Standing time is especially important in microwave cooking. Note that a microwaved cake is not placed on a cooling rack.
<b>Venting</b>	After covering a dish with plastic wrap, vent the plastic wrap by turning back one corner so excess steam can escape.



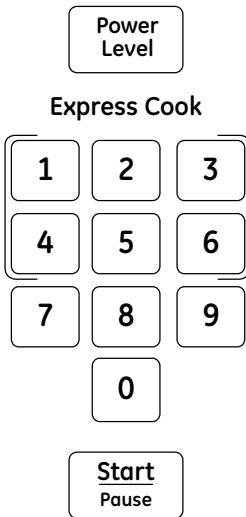

**6** Press **START**.

Variable power levels add flexibility to microwave cooking. The power levels on the microwave oven can be compared to the surface units on a range. Each power level gives you microwave energy a certain percent of the time. **Power level 7** is microwave energy 70% of the time. **Power level 3** is energy 30% of the time. Most cooking will be done on High (power level 10) which gives you 100% power. **Power level 10** will cook faster but food may need more frequent stirring, rotating or turning over. A lower setting will cook more evenly and need less stirring or rotating of the food. Some foods may have better flavor, texture or appearance if one of the lower settings is used. Use a lower power level when cooking foods that have a tendency to boil over, such as scalloped potatoes and some casseroles.

## Changing the Power Level

The power level may be entered or changed before or during cooking. **Power Level** is set for Level 10 (High) unless it is changed.

- 1** Press **Power Level** button.
- 2** Enter new power level by using the number pads or press the **Power Level** button multiple times until you find the level you want.
- 3** After you have selected the power level, wait five seconds. The display will go back to the **Cook Time** screen.
- 4** Enter cooking time and press **START**.

OR

- 1** Press **Cook Time** button.
- 2** Enter your cooking time.
- 3** Press **Power Level** button.
- 4** Enter new power level by using the number pads or press the **Power Level** button multiple times until you find the level you want.
- 5** After you have selected the power level, wait five seconds. The display will go back to the **Cook Time (Enter Time)** screen.

Rest periods (when the microwave energy cycles off) give time for the food to “equalize” or transfer heat to the inside of the food. An example of this is shown with **Power level 3**—the defrost cycle. If microwave energy did not cycle off, the outside of the food would cook before the inside was defrosted.

*Here are some examples of uses for various power levels:*

**High 10 (100%):** Fish, bacon, vegetables, boiling liquids.

**Med-High 7 (70%):** Gentle cooking of meat and poultry; baking casseroles and reheating.

**Medium 5 (50%):** Slow cooking and tenderizing for stews and less tender cuts of meat.

**Low 2 or 3 (20 or 30%):** Defrosting; simmering; delicate sauces.

**Warm 1 (10%):** Keeping food warm; softening butter.

**NOTE:** You can also change the power level during many cooking modes by pressing the power level button entering a valid power level.

## About the other features.

---

**Set  
Clock**

### **Clock**

To change the time of day.

- 1** Press the **Set Clock** button. (The microwave should not be running.)
- 2** Enter the appropriate time of day. Clock is on a 12-hour scale.
- 3** Press **Set Clock** or **Start** to accept the time.

**Start  
Pause**

### **Start/Pause**

In addition to starting many functions, **START/PAUSE** allows you to stop cooking without opening the door or clearing the display and resume cooking later.

**Cancel  
Off**

### **Cancel/Off**

Press the **CANCEL/OFF** button to stop and cancel cooking at any time.

**Cancel  
Off**

### **Control Lock-Out**

You may lock the control panel to prevent the oven from being accidentally started during cleaning or being used by children.

To lock or unlock the controls, press and hold the **CANCEL/OFF** button for three seconds. When the control panel is locked, **LOCKED** will be displayed briefly anytime a button or dial is pressed. "L" will show in the display.

**Surface  
Light**

### **Surface Light**

Press **SURFACE LIGHT** once for bright light, twice for the night light or a third time to turn the light off.



**NOTE:** The **Timer** indicator will be lit while the timer is operating.

### Timer

The **Timer** operates as a minute timer and can be used at any time, even when the oven is operating.

- 1** Press the **Timer** button.
- 2** Enter a time.
- 3** Press the **Timer** or **Start** button to start.

To cancel, press the **Timer** button. or **Cancel** button.

**NOTE:** If you press the **Cancel** button to cancel the timer and you are cooking at the same time, it will cancel your cooking selection also.

When time is up, the oven will signal.

To turn off the timer signal, press **Timer** or **Cancel**

### Display

If you have the Timer counting down and you are using the Cook Time at the same time, you can change the display to show either the timer or the cook time countdown.

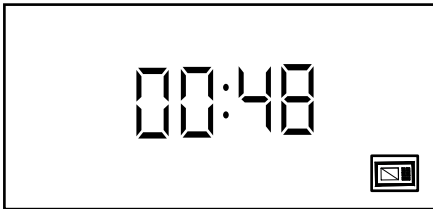

If the display shows the time for the Timer and you would like to view the Cook Time, press the **COOK TIME** button.

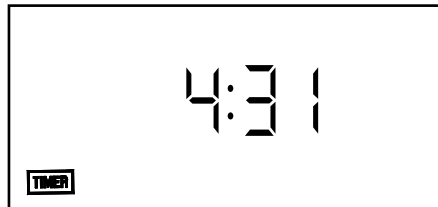

If the display shows the time for the Cook Time and you would like to view the Timer, press the **TIMER** button

## About the other features.

---

### Turntable

#### **Turntable**

For best cooking results, leave the turntable on. It can be turned off for large dishes.

Press the **Turntable** pad once to turn the turntable off. Press again to turn the turntable back on.

Sometimes the turntable can become too hot to touch. Be careful touching the turntable during and after cooking.

Turntable can be turned off during the **Cook Time** or **Express Cook** features by pressing the **Turntable** pad. **Note:** At the conclusion of the **Cook Time** and **Express Cook** features, the turntable will automatically return to ON.

### Vent Fan

#### **Vent Fan**

The vent fan removes steam and other vapors from surface cooking.

Press **Vent Fan** once for high fan speed, twice for low fan speed or three times to turn the fan off.

#### **Automatic Fan**

An automatic fan feature protects the microwave from too much heat rising from the cooktop below it. It automatically turns on if it senses too much heat.

If you have turned the fan on you may find that you cannot turn it off. The fan will automatically turn off when the internal parts are cool. It may stay on for 30 minutes or more after the cooktop and microwave controls are turned off.

---

#### **Insert Food Reminder**

A reminder will show on the display if the user tries to start the cooking cycle without placing food inside the microwave oven within 5 minutes prior to starting the cooking cycle.

---

#### **Cooking Complete Reminder**

To remind you that you have food in the oven, the oven will display "Food is ready" and beep once a minute until you either open the oven door or press the **CANCEL/OFF** button.



## Helpful Hints

An occasional thorough wiping with a solution of baking soda and water keeps the inside fresh.

*Be sure the power is off before cleaning any part of this microwave oven.*

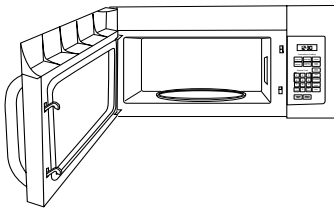

## How to Clean the Inside

### **Walls, Floor, Inside Window, Metal and Plastic Parts on the Door**

Some spatters can be removed with a paper towel; others may require a damp cloth. Remove greasy spatters with a sudsy cloth, then rinse with a damp cloth. Do not use abrasive cleaners or sharp utensils on oven walls.

*Never use a commercial oven cleaner on any part of your microwave.*

### **Removable Turntable and Turntable Support**

To prevent breakage, do not place the turntable into water just after cooking. Wash it carefully in warm, sudsy water or in the dishwasher. The turntable and support can be broken if dropped. Remember, do not operate the oven in the microwave mode without the turntable and support seated and in place.

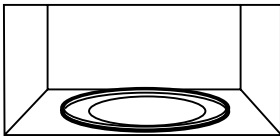

# Care and cleaning of the oven.

---

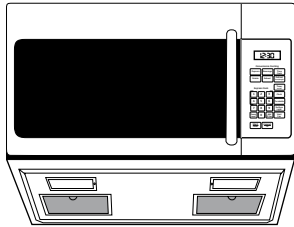
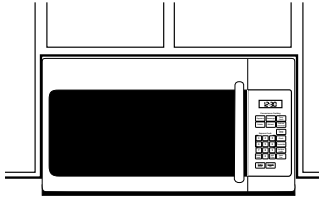

## **How to Clean the Outside**

*We recommend against the use of spray cleaners and using cleaners with ammonia or alcohol, as they can damage the appearance of the microwave oven. If you choose to use a common household cleaner, first apply the cleaner directly to a clean cloth, then wipe the soiled area.*

### **Case**

Clean the outside of the microwave with a sudsy cloth. Rinse and then dry. Wipe the window clean with a damp cloth.

### **Control Panel**

Wipe with a damp cloth. Dry thoroughly. Do not use cleaning sprays, large amounts of soap and water, abrasives or sharp objects on the panel—they can damage it. Some paper towels can also scratch the control panel.

### **Door Panel**

Before cleaning the front door panel, make sure you know what type of panel you have. Refer to the eighth digit of the model number. "S" is stainless steel "B", "W" or "C" are plastic colors.

### **Stainless Steel (on some models)**

The stainless steel panel can be cleaned with Stainless Steel Magic or a similar product using a clean, soft cloth. Apply stainless cleaner carefully to avoid the surrounding plastic parts. Do not use appliance wax, polish, bleach or products containing chlorine on Stainless Steel finishes.

### **Plastic Color Panels**

Use a clean, soft, lightly dampened cloth, then dry thoroughly.

### **Door Seal**

It's important to keep the area clean where the door seals against the microwave. Use only mild, non-abrasive detergents applied with a clean sponge or soft cloth. Rinse well.

### **Bottom**

Clean off the grease and dust on the bottom often. Use a solution of warm water and detergent.

## Replacing the light bulb.

GEAppliances.ca

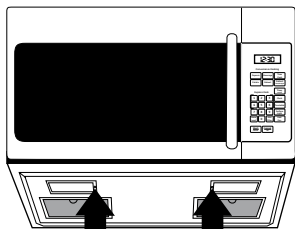

Remove screws.

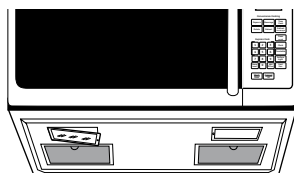

### Cooktop Lights/Nite Lights

Replace with 120 volt, 25 or 50 watt (max.) incandescent bulbs. Order WB25X10030 from your GE supplier.

- 1 To replace the cooktop lights/nite lights, first disconnect the power at the main fuse or circuit breaker panel, or pull the plug.
- 2 One side at a time, remove the screw from the side of the light compartment cover and lower the cover until it stops.
- 3 Be sure the bulb is cool before removing. Break the adhesive seal by gently unscrewing the bulb.
- 4 Screw in the new bulb, then raise the light cover and replace the screw. Repeat for the other light. Connect electrical power to the oven.

### Replacing the Oven Cavity Lamp

1. Disconnect power at the main fuse or circuit breaker panel.
2. Remove the top grill by removing the two screws that hold it in place.
3. Remove charcoal filter if present. **NOTE:** Charcoal filter is an optional kit, you may not have one.
4. Press the retainer holding the lamp shield in place.
5. Pull the lamp shield out. Unscrew the light bulb out and replace with the 120V-130V, 30W incandescent bulb. Order WB25X10029 from your GE supplier.
6. Return the lamp and lamp shield to original position and replace charcoal filter.
7. Replace the grill and 2 screws. Reconnect power to the oven.

## About the exhaust feature.

Charcoal filter (on some models).

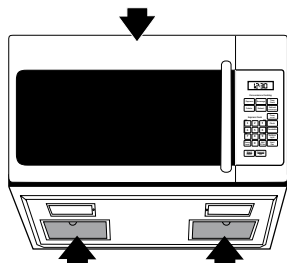

Reusable vent filters  
(on all models).

### Vent Fan

The vent fan has two metal reusable vent filters. Models that recirculate air back into the room also use a charcoal filter.

### Reusable Vent Filters

The metal filters trap grease released by foods on the cooktop. They also prevent flames from foods on the cooktop from damaging the inside of the oven.

For this reason, the filters must always be in place when the hood is used. The vent filters should be cleaned once a month, or as needed.

# Care and cleaning of the oven.

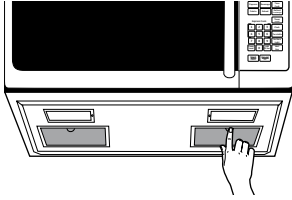

## Removing and Cleaning the Filters

**To remove**, slide them to the rear using the tabs. Pull down and out.

To clean the vent filters, soak them and then swish around in hot water and detergent. Don't use ammonia or ammonia products because they will darken the metal. Light brushing can be used to remove embedded dirt.

Rinse, shake and let dry before replacing.

**To replace**, slide the filters into the frame slots on the back of each opening. Press up and to the front to lock into place.

## Charcoal Filter

**The charcoal filter cannot be cleaned. It must be replaced. Order Part No. WB02X11550 from your GE supplier.**

If the model is not vented to the outside, the air will be recirculated through a disposable charcoal filter that helps remove smoke and odors.

The charcoal filter should be replaced when it is noticeably dirty or discolored (usually after 6 to 12 months, depending on usage). See "Optional Kits," page 8, for more information.

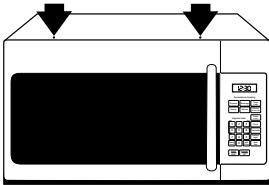

Remove 2 grille screws to remove the grille.

## To Remove the Charcoal Filter

**To remove the charcoal filter**, first disconnect power at the main fuse or circuit breaker, or pull the plug. Remove the top grille by removing the two screws that hold it in place.

You may need to open the cabinet doors to remove the screws.

Press back on the top of the filter with both hands until the filter lays down almost horizontal. Lift the filter at the bottom until it comes free of the tabs. Slide the filter down and out.

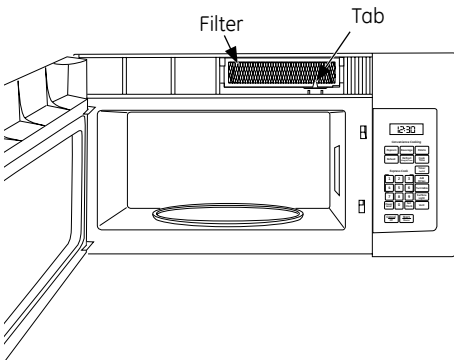



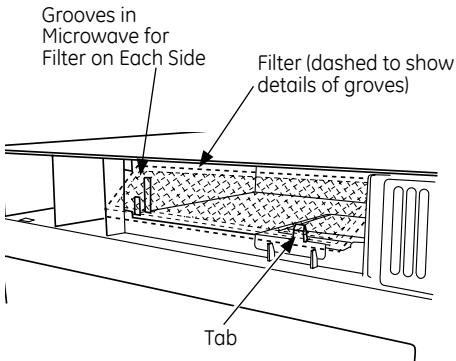

### **To Install the Charcoal Filter**

**To install a new charcoal filter**, remove plastic and other outer wrapping from the new filter.

Insert the top of the filter up and into the grooves on both sides of the inside of the top opening. Once you have cleared the bottom tab, push the bottom of the filter in until it rests in place behind the tab.

## ***Before you call for service....***

### **Things That Are Normal With Your Microwave Oven**

- Moisture on the oven door and walls while cooking. Wipe the moisture off with a paper towel or soft cloth.
- Moisture between the oven door panels when cooking certain foods. Moisture should dissipate shortly after cooking is finished.
- Steam or vapor escaping from around the door.
- Light reflection around door or outer case.
- Dimming oven light and change in the blower sound at power levels other than high.
- Noises while oven is operating.
- TV-radio interference might be noticed while using the microwave. Similar to the interference caused by other small appliances, it does not indicate a problem with the microwave. Plug the microwave into a different electrical circuit, move the radio or TV as far away from the microwave as possible or check the position and signal of the TV/radio antenna.

## Before you call for service....



### Troubleshooting Tips

Save time and money! Review the charts on the following pages first and you may not need to call for service.

<b>Problem</b>	<b>Possible Cause</b>	<b>What To Do</b>
<b>Oven will not start</b>	A fuse in your home may be blown or the circuit breaker tripped.	<ul style="list-style-type: none"> <li>• Replace fuse or reset circuit breaker.</li> </ul>
	Power surge.	<ul style="list-style-type: none"> <li>• Unplug the microwave oven, then plug it back in.</li> </ul>
	Plug not fully inserted into wall outlet	<ul style="list-style-type: none"> <li>• Make sure the 3-prong plug on the oven is fully inserted into wall outlet.</li> </ul>
	Door not securely closed.	<ul style="list-style-type: none"> <li>• Open the door and close securely.</li> </ul>
<b>Control panel lighted, yet oven will not start</b>	Door not securely closed.	<ul style="list-style-type: none"> <li>• Open the door and close securely.</li> </ul>
	START/PAUSE button not pressed after entering cooking selection.	<ul style="list-style-type: none"> <li>• Press <b>START/PAUSE</b>.</li> </ul>
	Another selection entered already in oven and CANCEL/OFF button not pressed to cancel it.	<ul style="list-style-type: none"> <li>• Press <b>CANCEL/OFF</b>.</li> </ul>
	Cooking time not entered after pressing COOK TIME	<ul style="list-style-type: none"> <li>• Make sure you have entered cooking time after pressing <b>COOK TIME</b>.</li> </ul>
	CANCEL/OFF was pressed accidentally.	<ul style="list-style-type: none"> <li>• Reset cooking program and press <b>START/PAUSE</b>.</li> </ul>
<b>CONTROL LOCKED appears on display</b>	The control has been locked.	<ul style="list-style-type: none"> <li>• Press and hold <b>CANCEL/OFF</b> for about 3 seconds to unlock the control.</li> </ul>
<b>Floor of the oven is warm even when the oven has not been used</b>	The cooktop light is located below the oven floor. When light is on, the heat it produces may make the oven floor get warm.	<ul style="list-style-type: none"> <li>• This is normal.</li> </ul>
<b>You hear an unusual low-tone beep</b>	You have tried to change the power level when it is not allowed	<ul style="list-style-type: none"> <li>• Many of the oven's features are preset and cannot be changed.</li> </ul>
<b>Vent fan comes on automatically</b>	The vent fan automatically turns on to protect the microwave if it senses too much heat rising from the cooktop below.	<ul style="list-style-type: none"> <li>• This is normal.</li> </ul>

Please place in envelope and mail to:  
Veuillez mettre dans une enveloppe et envoyez à :

**OWNERSHIP REGISTRATION  
P.O. BOX 1780  
MISSISSAUGA, ONTARIO  
L4Y 4G1  
(FOR CANADIAN CONSUMERS ONLY -  
POUR RÉSIDENTS CANADIENS SEULEMENT)**

CUT ALONG THIS LINE AND RETURN CARD - THANKS  
 DÉCOUPEZ ICI ET ENVOYEZ LA FICHE - MERCI



For Canadian  
Customers



Pour les  
consommateurs  
canadiens

### OWNERSHIP REGISTRATION CERTIFICATE – FICHE D'INSCRIPTION DU PROPRIÉTAIRE

Please register your product to enable us to contact you in the remote event a safety notice is issued for this product and to allow for efficient communication under the terms of our warranty, should the need arise. Veuillez enregistrer votre produit afin de nous permettre de communiquer avec vous si jamais un avis de sécurité concernant ce produit était émis et de communiquer facilement avec vous en vertu de votre garantie, si le besoin s'en fait sentir.

REGISTER ON-LINE: [www.geappliances.ca](http://www.geappliances.ca) MAIL TO: **P.O. BOX 1780, MISSISSAUGA**  
 ENREGISTREMENT SUR INTERNET À : [www.electromenagersge.ca](http://www.electromenagersge.ca) POSTEZ À : **ONTARIO, L4Y 4G1**

MR./M.  MRS./MME.  MS. FIRST NAME / PRÉNOM LAST NAME / NOM

STREET NO./N° RUE STREET NAME / RUE APT./NOI/APP./RR#

CITY / VILLE PROVINCE POSTAL CODE / CODE POSTAL

AREA CODE / IND. RÉG. TELEPHONE / TÉLÉPHONE E-MAIL / COURRIEL

DID YOU PURCHASE A SERVICE CONTRACT FOR THIS APPLIANCE? YES/ OUI  IF YES/ SI OUI : EXPIRATION  
 AVEZ-VOUS ACHETÉ UN CONTRAT DE SERVICE POUR CET APPAREIL ? NON/ NON  YA M DU

NAME OF SELLING DEALER / NOM DU MARCHAND MODEL / MODÈLE

INSTALLATION DATE / DATE D'INSTALLATION CORRESPONDENCE  ENGLISH  
 YA M DU DU CORRESPONDANCE  FRANÇAIS SERIAL / SÉRIE

I do not wish to receive any promotional offers regarding this product.  
 Je ne désire pas recevoir d'offres promotionnelles concernant ce produit.

# GE Microwave Oven Warranty.



All warranty service provided by our Factory Service Centers, or an authorized Customer Care® technician. To schedule service, online, contact us at [GEAppliances.ca](http://GEAppliances.ca), or call 1.800.561.3344. Please have serial and model numbers available when calling for service.

Staple your receipt here. Proof of the original purchase date is needed to obtain service under the warranty.

<b>For The Period of:</b>	<b>Mabe Will Replace</b>
<b>One Year</b> <i>From the date of the original purchase</i>	<b>Any part</b> of the microwave oven which fails due to a defect in materials or workmanship During this <b>limited one-year warranty</b> , Mabe will also provide, <b>free of charge</b> , all labor and related service to replace the defective part.

## What Mabe Will Not Cover:

- Service trips to your home to teach you how to use the product.
- Improper installation, delivery or maintenance.
- Product not accessible to provide required service.
- Failure of the product or damage to the product if it is abused, misused (for example, cavity arcing from wire rack or metal/foil), or used for other than the intended purpose or used commercially.
- Replacement of house fuses or resetting of circuit breakers.
- Replacement of the cooktop light bulbs.
- Damage to the product caused by accident, fire, floods or acts of God.
- Incidental or consequential damage caused by possible defects with this appliance.
- Damage caused after delivery.

**EXCLUSION OF IMPLIED WARRANTIES—Your sole and exclusive remedy is product exchange as provided in this Limited Warranty. Any implied warranties, including the implied warranties of merchantability or fitness for a particular purpose, are limited to one year or the shortest period allowed by law.**

*This warranty is extended to the original purchaser and any succeeding owner for products purchased for home use within Canada. If the product is located in an area where service by a Mabe Authorized Servicer is not available, you may be responsible for a trip charge or you may be required to bring the product to an Authorized Mabe Service Location for service.*

*Some provinces do not allow the exclusion or limitation of incidental or consequential damages. This warranty gives you specific legal rights, and you may also have other rights which vary from province to province. To know what your legal rights are, consult your local or provincial consumer affairs office.*

**Warrantor: Mabe Canada Inc., Burlington, Ontario**

# Consumer Support.

---



## GE Appliances Website

[GEAppliances.ca](http://GEAppliances.ca)

Have a question or need assistance with your appliance? Try the GE Appliances Website 24 hours a day, any day of the year! For greater convenience and faster service, you can now download Owner's Manuals, order parts, catalogs.

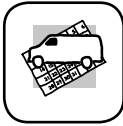

## Schedule Service

[GEAppliances.ca](http://GEAppliances.ca)

Expert Mabe repair service is only one step away from your door. Get on-line and schedule your service at your convenience any day of the year! Or call 1.800.561.3344 during normal business hours.



## Service Contrats

[GEAppliances.ca](http://GEAppliances.ca)

Purchase a Mabe extended warranty and learn about special discounts that are available while your warranty is still in effect. You can purchase it on-line anytime, or call 1.800.461.3636 during normal business hours. Mabe Consumer Home Services will still be there after your warranty expires.



## Parts and Accessories

[GEAppliances.ca](http://GEAppliances.ca)

Individuals qualified to service their own appliances can have parts or accessories sent directly to their homes (VISA, MasterCard and Discover cards are accepted). Order on-line today, 24 hours every day or by phone at 1.800.661.1616 during normal business hours.

**Instructions contained in this manual cover procedures to be performed by any user. Other servicing generally should be referred to qualified service personnel. Caution must be exercised, since improper servicing may cause unsafe operation.**



## Contact Us

[GEAppliances.ca](http://GEAppliances.ca)

If you are not satisfied with the service you receive from Mabe, contact us on our Website with all the details including your phone number, or write to:

General Manager, Customer Relations  
Mabe Canada Inc,  
Suite 310, 1 Factory Lane,  
Moncton NB E1C 9M3



## Register Your Appliance

[GEAppliances.ca](http://GEAppliances.ca)

**Register your new appliance on-line- at your convenience!** Timely product registration will allow for enhanced communication and prompt service under the terms of your warranty, should the need arise. You may also mail in the pre-printed registration card included in the packing material.