



www.GEAppliances.com

Icemaker Accessory Kit

Addendum for IM4, IM4A and IM6 Icemaker Kits

IMPORTANT: These instructions are needed to install an icemaker in your refrigerator. To be used with an IM4, IM4A or IM6 Icemaker Kit. Keep this addendum with your Owner's Manual and Installation Instructions.

Installation Instructions Addendum

These instructions are to be used to install an Icemaker Kit in the models listed below.

GBS20KB
GBS22HB
GBS22KB
PDS20MB
PDS20SB
PDS22MB
PDS22SB



Installation Instructions

NEEDED CONTENTS OF KIT

The following are a list of the parts from the kit that will be needed to install the icemaker.

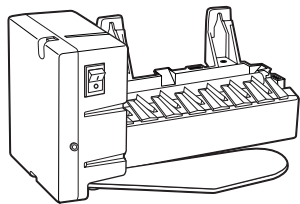

① Icemaker



② Owner's Manual & Installation Instructions

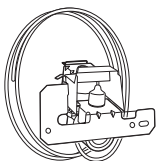

③ Water Valve and Tube Assembly



④ Adhesive-Backed Water Tube Fasteners, to secure plastic water tube (4)



⑤ Hex-Head Screw for Water Line Clamp



⑥ Water Line Clamp (strain relief), for house water line



⑦ Warranty Label



⑧ Hex-Head Screw, for attaching water valve



⑨ Phillips Head Screws, for mounting icemaker (2)



⑩ Water Tube Inlet

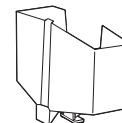

⑪ Icemaker Fill Cup (side-mounted)



⑫ Hose Clamp

PARTS REQUIRED THAT CAME WITH THE REFRIGERATOR

If the fill tube has been misplaced, call 1.800.626.2002 and order part WR02X11712.



Fill Tube with Foil (5/8" O.D.)

Installation Instructions

BEFORE YOU BEGIN

Read each step thoroughly before proceeding.

- **CAUTION** — Unplug the Refrigerator. To eliminate the danger of electric shock during installation, you must unplug the refrigerator from its electrical outlet.

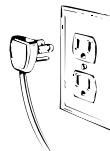

TOOLS YOU WILL NEED



Flat blade and Phillips screwdrivers



Pliers



Sharp knife

1 PREPARE FOR INSTALLATION

- Remove the storage basket (on some models) by pulling it out to the stop position and lifting it up and out.

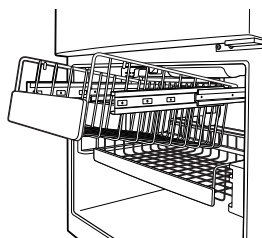

Note: After removing the basket, push the extension arms back into the freezer compartment.

- Remove the chiller shelf (on some models) by pulling it straight out.

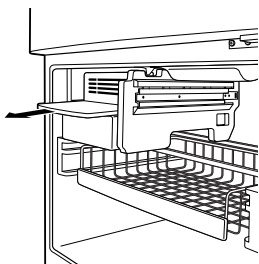

- Remove the ice bucket by pulling it out and lifting it up and out.

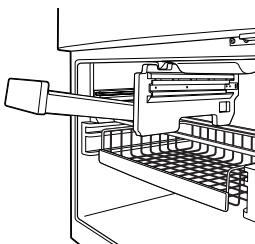

- Remove the center vertical shelf support (on some models) by lifting it and rotating its bottom to the right.

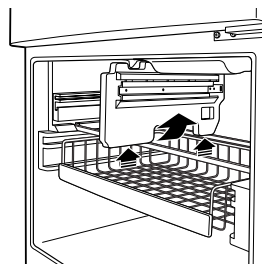

1 PREPARE FOR INSTALLATION (cont.)

- Inside the freezer, remove the two small white plug buttons (on some models) from the side wall. (If screws are present instead of plugs, leave them in place.)
- Remove and discard the large white plug from the rear freezer wall. Pull out the gray insulation plug and remove any debris.
- Remove the outlet cover with a flat-blade screwdriver.

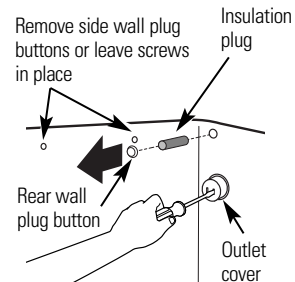

2 INSTALL FILL TUBE

- Slide the **fill tube** shipped with the refrigerator onto the **water tube inlet** (10). If the fill tube has been misplaced, call 1.800.626.2002 and order part WR02X11712.
- Go to the back of the refrigerator. Remove the label covering the hole. Pull out the insulation plug and any debris.
- On the tube side of the **water tube inlet** (10), there is an adhesive backing. Remove the adhesive backing and slide the tube into the hole at the back of the refrigerator. Firmly press on the inlet to secure it to the refrigerator.

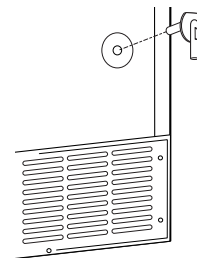

3 SET POWER SWITCH TO O (off)

Set the **icemaker power switch** to **O** (off). Leave the power switch in the **O** (off) position until the refrigerator is connected to the water supply to prevent premature operation.

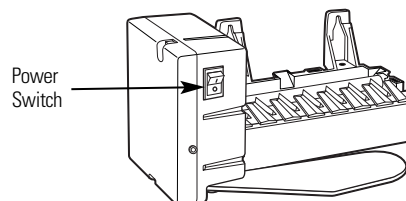

Installation Instructions

4 INSTALL THE MOUNTING SCREWS

- Skip to Step 5 if screws are already in place in the freezer side wall.
- Install two self-tapping **Phillips head screws** (9) from the kit in the holes in the side wall. The screw heads should extend about 1/2" (13 mm) from the side wall.

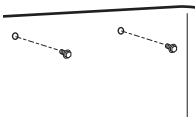

5 INSTALL THE ICEMAKER FILL CUP

Install the **icemaker fill cup** (side-mounted) (11) into the icemaker as shown.

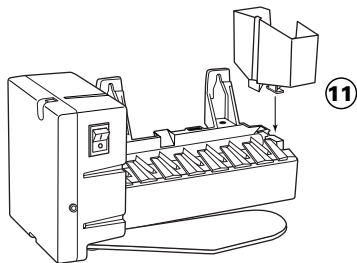

6 PLUG IN THE ICEMAKER

Holding the icemaker in place, insert the **icemaker power cord plug** into the socket on the rear wall, making sure the prongs and holes are matched. Press the plug firmly into the socket. Lock the plug in place by clipping the restraints onto each side of the plug. Make sure the restraints click into place. Make sure the power cord is still in the hook on the back of the icemaker.

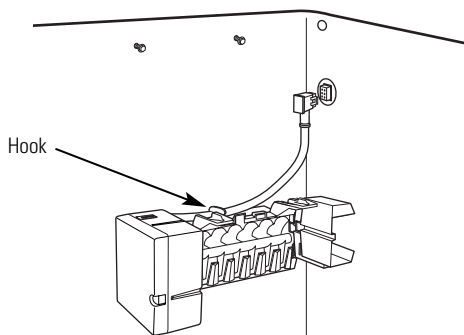

7 MOUNT THE ICEMAKER

- Lift the icemaker so the **fill tube** shipped with the refrigerator fits in the **fill cup opening** (E). Hang the **icemaker** on the two **mounting screws** (9) in the side wall.

Make sure:

- **The power cord is still firmly in the socket.**
- The **fill tube** extends into the fill cup opening on the back of the icemaker. (Check the rear of the refrigerator to make sure the fill tube has not been pushed out of the back of the refrigerator).
- The icemaker mounting screws are located in the uppermost position of the mounting slots.
- The icemaker is level.
- The icemaker power switch is set to **O** (off).

THEN SECURELY TIGHTEN THE ICEMAKER MOUNTING SCREWS.

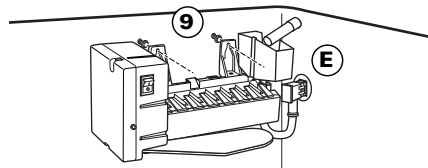

8 RE-INSTALL THE SHELF SUPPORT, BUCKET, SHELF AND BASKET

Replace the center vertical shelf support, ice bucket, chiller shelf and storage basket by reversing the steps in Step 1.

9 ATTACH WARRANTY LABEL

A **label** (7) is provided with this kit to record the date of installation for warranty purposes. Apply it to the back of the refrigerator.

10 KEEP THIS ADDENDUM

Keep this addendum with your Refrigerator Owner's Manual and Installation Instructions.

The icemaker installation inside the freezer is now complete. Continue to the *Water Valve Assembly* section.

Installation Instructions

WATER VALVE ASSEMBLY INSTALLATION INSTRUCTIONS

BEFORE YOU BEGIN

Read each step thoroughly before proceeding.

- **CAUTION** — Unplug the Refrigerator. To eliminate the danger of electric shock during installation, you must unplug the refrigerator from its electrical outlet.



3 ATTACH THE WATER VALVE

- Locate the female connector plug (C).

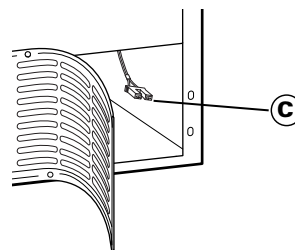

TOOLS YOU WILL NEED



Flat blade and Phillips screwdrivers



Pliers



Sharp knife



1/4" and 5/16" Nutdrivers

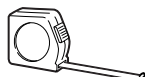

Tape measure

- Plug the female connector (C) onto the male terminals on the water valve (3). Either wire can go on either terminal.

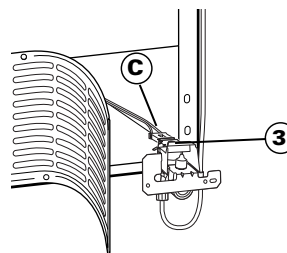

1 REMOVE THE COVER

At the bottom rear of the refrigerator, remove the screws holding the access cover.

Bend the cover back to access the compartment.

Be sure to save the screws as the access cover must be reinstalled later to ensure that your refrigerator will function properly.

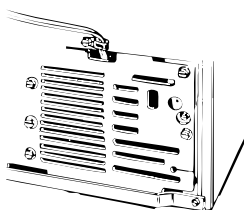

- Fasten the water valve to the cabinet by driving the hex-head screw (8) from the kit into the hole in the cabinet leg.

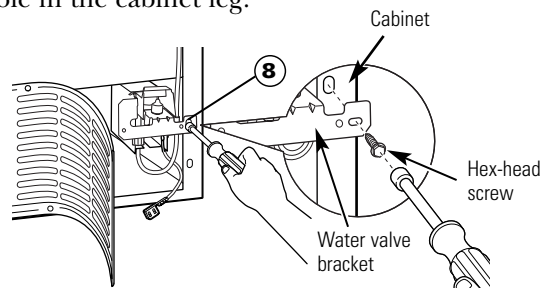

2 CUT PLASTIC WATER TUBING

- Measure 25" (64 cm) of water tubing starting from where it is secured to the water valve. Cut off excess tubing with a sharp knife or single-edge razor blade.

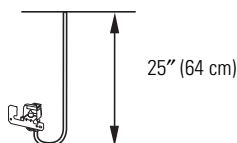

Installation Instructions

3 ATTACH THE WATER VALVE (cont.)

- Clip the end of the ground wire to the refrigerator cabinet.

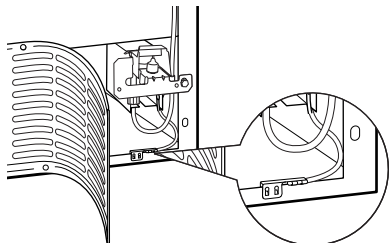

IMPORTANT: To ensure a proper ground, the end of the ground wire **MUST** be secured to the refrigerator cabinet.

4 CONNECT WATER TUBE TO INLET

- Squeeze the ends of the **hose clamp** (12) from the kit with pliers and slide the clamp over the inlet, located on the right side of the refrigerator.
- While still squeezing the clamp, insert the free end of the **water tube** (3) into the inlet as far as it will go.
- Then slide the clamp downward to capture the water tube in place.
- Using one of the **adhesive-backed fasteners** (4), secure the water tube to the back of the refrigerator about 1/2" below the inlet.

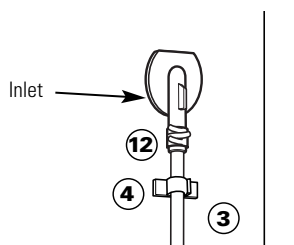

5 INSTALL WATER LINE CLAMP

- Attach the **water line clamp** (strain relief) (6) from the kit to the refrigerator. With the clamp directly in line with the water valve, drive the **screw** (5) from the kit through the **clamp** (6) at the indent into the back of the cabinet.

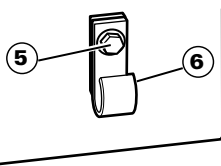

- The metal clamp is for the house water line (see Water Line Installation Instructions). It is not to be used for the water tube from the water valve up to the inlet.

6 ROUTE AND ATTACH THE WATER TUBE

- Fasten the plastic water tube to the back of the refrigerator with three of the **adhesive-backed fasteners** (4), spacing the fasteners as shown.

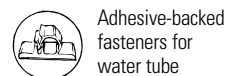
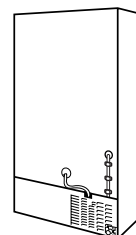

7 WATER VALVE INSTALLED

Refer to the *Water Line Installation Instructions* for connection to the home water supply. After water line installation is completed, set the **icemaker power switch** to **I** (on).

Even when the icemaker power switch is in the **I** (on) position, power to the icemaker will be interrupted when the freezer door/drawer is open. This prevents ice ejecting from the icemaker from missing the ice bucket and dropping into the back of the freezer. Because power to the icemaker is interrupted while the door/drawer is open, the green power light on the icemaker will be off. To make sure the icemaker is working properly, press the freezer light switch located on the upper right side of the freezer compartment. The power light on the icemaker will come on.

Note: After installing the icemaker, **do not** open the door/drawer for approximately 4 hours. This will allow the freezer to reach the correct operating temperature for making ice, and will prevent water from spilling out of the icemaker mold.

Proceed with the appropriate step in the *Installing the Water Line* section in the Owner's Manual and Installation Instructions to complete the installation.

Notes
