



# Top-Freezer Refrigerators

**Safety Instructions**

- Connect Electricity ..... 3
- Extension Cords ..... 2
- Proper Disposal ..... 2
- Safety Precautions ..... 2

**Operating Instructions**

- Automatic Icemaker ..... 8
- Controls ..... 4
- Crispers and Pans ..... 7-8
- Shelves and Bins ..... 5-6

**Care and Cleaning** ..... 9

- Replacing the Light Bulbs ..... 10

**Installation Instructions**

- Preparing to Install the Refrigerator ..... 11
- Reversing the Door Swing ..... 16-20
- Water Line Installation ..... 12-16

**Troubleshooting Tips** ..... 21-23

- Normal Operating Sounds ..... 21

**Consumer Support**

- Consumer Support ..... Back Cover
- Consumer Product Ownership Registration ..... 25-26
- Warranty for Canadian Customers ... 24

**Write the model and serial numbers here:**

**Model #** \_\_\_\_\_

**Serial #** \_\_\_\_\_

Find these numbers on the gray label on the left side, near the top of the refrigerator compartment.

**Owner's Manual & Installation Instructions**

*Models 20*

Congélateur supérieur  
**Réfrigérateurs**

**Manuel d'utilisation et d'installation**

*La section française commence à la page 27*

Congelador superior  
**Refrigeradores**

**Manual del propietario e instalación**

*La sección en español empieza en la página 55*



## IMPORTANT SAFETY INFORMATION. READ ALL INSTRUCTIONS BEFORE USING.

### ⚠ **WARNING!**

Use this appliance only for its intended purpose as described in this Owner's Manual.



### SAFETY PRECAUTIONS

When using electrical appliances, basic safety precautions should be followed, including the following:

- This refrigerator must be properly installed and located in accordance with the Installation Instructions before it is used.
- Do not allow children to climb, stand or hang on the shelves in the refrigerator. They could damage the refrigerator and seriously injure themselves.
- Do not touch the cold surfaces in the freezer compartment when hands are damp or wet. Skin may stick to these extremely cold surfaces.
- Do not store or use gasoline or other flammable vapors and liquids in the vicinity of this or any other appliance.
- In refrigerators with automatic icemakers, avoid contact with the moving parts of the ejector mechanism, or with the heating element located on the bottom of the icemaker. Do not place fingers or hands on the automatic icemaking mechanism while the refrigerator is plugged in.
- Keep fingers out of the "pinch point" areas; clearances between the doors and between the doors and cabinet are necessarily small. Be careful closing doors when children are in the area.
- Unplug the refrigerator before cleaning and making repairs.
 

**NOTE:** We strongly recommend that any servicing be performed by a qualified individual.
- Setting the controls to the **0 (off)** position does not remove power to the light circuit. On some models, only the refrigerator control has a **0 (off)** setting.
- Do not refreeze frozen foods which have thawed completely.

### ⚠ **DANGER! RISK OF CHILD ENTRAPMENT**

#### PROPER DISPOSAL OF THE REFRIGERATOR

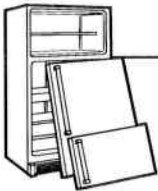

Child entrapment and suffocation are not problems of the past. Junked or abandoned refrigerators are still dangerous...even if they will sit for "just a few days." If you are getting rid of your old refrigerator, please follow the instructions below to help prevent accidents.

#### **Before You Throw Away Your Old Refrigerator or Freezer:**

- Take off the doors.
- Leave the shelves in place so that children may not easily climb inside.

#### **Refrigerants**

All refrigeration products contain refrigerants, which under federal law must be removed prior to product disposal. If you are getting rid of an old refrigeration product, check with the company handling the disposal about what to do.



#### USE OF EXTENSION CORDS

Because of potential safety hazards under certain conditions, we strongly recommend against the use of an extension cord.

However, if you must use an extension cord, it is absolutely necessary that it be a UL-listed (in the United States) or a CSA-listed (in Canada), 3-wire grounding type appliance extension cord having a grounding type plug and outlet and that the electrical rating of the cord be 15 amperes (minimum) and 120 volts.

**⚠ WARNING!****HOW TO CONNECT ELECTRICITY**

*Do not, under any circumstances, cut or remove the third (ground) prong from the power cord. For personal safety, this appliance must be properly grounded.*

The power cord of this appliance is equipped with a 3-prong (grounding) plug which mates with a standard 3-prong (grounding) wall outlet to minimize the possibility of electric shock hazard from this appliance.

Have the wall outlet and circuit checked by a qualified electrician to make sure the outlet is properly grounded.

If the outlet is a standard 2-prong outlet, it is your personal responsibility and obligation to have it replaced with a properly grounded 3-prong wall outlet.

The refrigerator should always be plugged into its own individual electrical outlet which has a voltage rating that matches the rating plate.

This provides the best performance and also prevents overloading house wiring circuits which could cause a fire hazard from overheated wires.

Never unplug your refrigerator by pulling on the power cord. Always grip plug firmly and pull straight out from the outlet.

Repair or replace immediately all power cords that have become frayed or otherwise damaged. Do not use a cord that shows cracks or abrasion damage along its length or at either end.

When moving the refrigerator away from the wall, be careful not to roll over or damage the power cord.



*READ AND FOLLOW THIS SAFETY INFORMATION CAREFULLY.*

**SAVE THESE INSTRUCTIONS**

## About the controls on the refrigerator.

The control will look like the following:

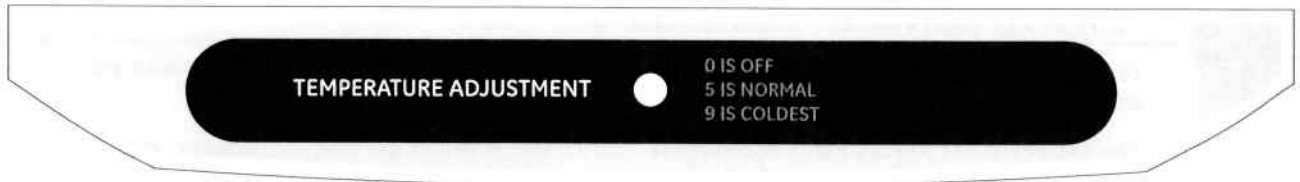

**NOTE:** The refrigerator is shipped with protective film covering the temperature controls. If this film was not removed during installation, remove it now.

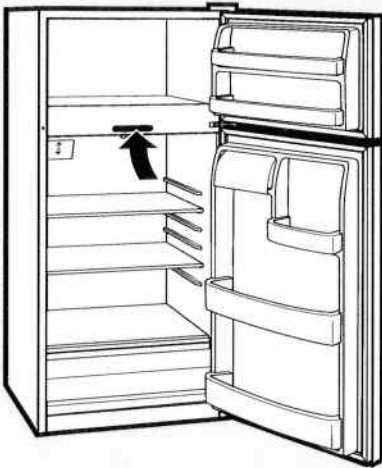

Initially, set the refrigerator control at **5** and allow 12–24 hours for the temperature to stabilize.

Several adjustments may be required. Adjust the controls one increment at a time, and allow 12 hours after each adjustment for the refrigerator to reach the temperature you have set.

Setting the controls to **0** stops cooling the refrigerator and but does not shut off electrical power to the refrigerator.

**Control settings will vary based on personal preferences, usage and operating conditions and may require more than one adjustment.**

Not all features are on all models.

## Rearranging the Shelves

Shelves in the refrigerator and freezer compartments are adjustable. Remove all items from the shelves before any adjustment.

### Refrigerator Compartment

#### To remove:

- 1 Tilt the shelf up at the front.
- 2 Pull the shelf out.

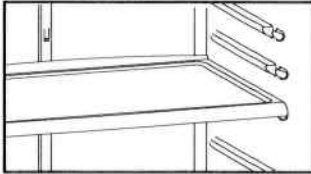

**Full shelf**  
Some models have wire shelves that can be adjusted in the same manner.

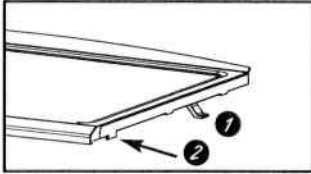

#### To replace:

- 1 While tilting the shelf up, insert it in the refrigerator rib.
- 2 Slide in the shelf, until the shelf stop fits with the rib

#### To remove:

- 1 Tilt the shelf up at the front.
- 2 Lift the shelf up at the back and bring the shelf out

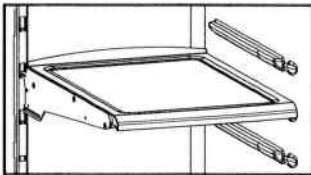

**Half shelf**

#### To replace:

- 1 While tilting the shelf up, insert the top hook at the back of the shelf in a slot on the track. Use the right slot for the right shelf and vice versa.
- 2 Lower the front of the shelf until the bottom of the shelf locks into place.

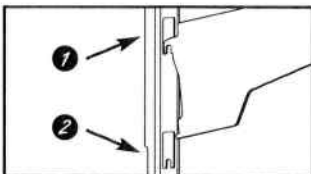

### Freezer Compartment

#### To remove:

- 1 Lift up the left side of the shelf and slide it left into the center of the shelf supports.
- 2 Rotate the right side of the shelf up and out of the shelf supports.

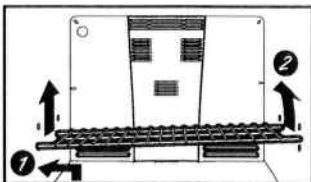

#### To replace:

- 1 Holding the shelf diagonally, insert the left end of the shelf into the center of the shelf supports on the side wall.
- 2 Insert the right end of the shelf into the shelf supports. Rest each end of the shelf on the bottom of the shelf supports.

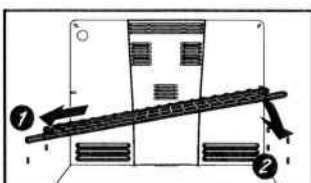

## About the shelves and bins (cont.)

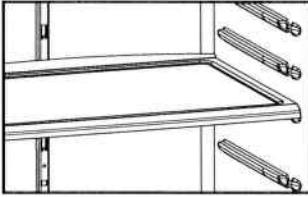

### **Spill proof Shelves** (on some models)

Spill proof shelves have special edges to help prevent spills from dripping to lower shelves. To remove or replace the shelves, see. *Rearranging the Shelves.*

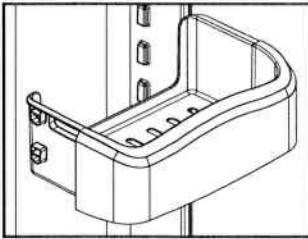

### **Adjustable Bins on the Door**

Adjustable bins can easily be carried from refrigerator to work area.

#### **To remove:**

Lift bin straight up, then pull out.

#### **To replace or relocate:**

Slide in the bin just above the molded door supports, and push down. The bin will lock in place.

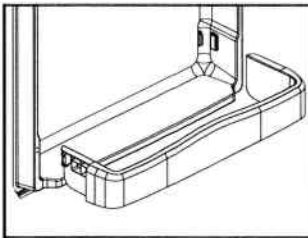

### **Non-Adjustable Shelves on the Door**

Remove all items from the shelf door.

#### **To remove:**

Lift the shelf straight up, then pull out.

**To replace:** Engage the shelf in the molded supports on the door and push down. It will lock in place.

# About the crispers and pans.

geappliances.ca

Not all features are on all models.

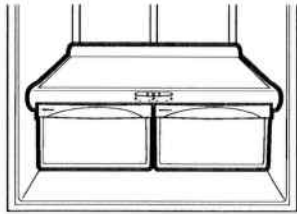

## Fruit and Vegetable Crisper

Excess water that may accumulate in the bottom of the drawers or under the drawers should be wiped dry.

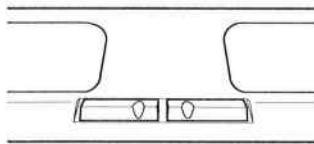

## Adjustable Humidity Crisper (on some models)

Slide the control all the way to the **HIGH** setting to provide high humidity recommended for most vegetables.

Slide the control all the way to the **LOW** setting to provide lower humidity levels recommended for most fruits.

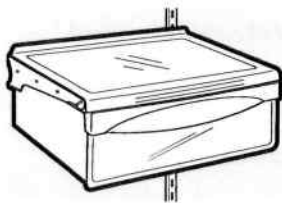

## Snack Pan (on some models)

This pan can be moved to the most useful location for your family's needs.

**To remove**, slide the pan out to the **stop** position, lift the pan up and past the **stop** position and lift it out.

Safety Instructions

Operating Instructions

Installation Instructions

Troubleshooting Tips

Consumer Support

## About crisper removal.

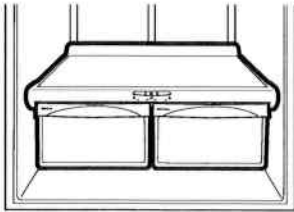

### To Remove:

These drawers can be removed easily by lifting up slightly while pulling the drawer past the **stop** location.

## About the automatic icemaker. (on some models)

A newly-installed refrigerator may take 12–24 hours to begin making ice.

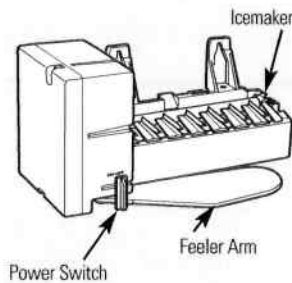

(Appearance may vary)

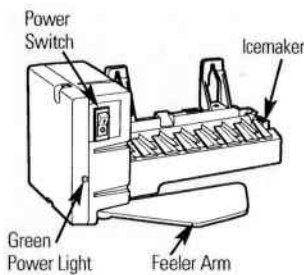

Power switch model

### Automatic Icemaker

The icemaker will produce seven cubes per cycle - approximately 100-130 cubes in a 24-hour period, depending on freezer compartment temperature, room temperature, number of door openings and other use conditions.

If the refrigerator is operated before the water connection is made to the icemaker, set the power switch to **OFF**.

When the refrigerator has been connected to the water supply, set the power switch to **ON**.

The icemaker will fill with water when it cools to freezing. A newly-installed refrigerator may take 12 to 24 hours to begin making ice cubes.

Throw away the first few batches of ice to allow the water line to clear. Be sure nothing interferes with the sweep of the feeler arm.

When the bin fills to the level of the feeler arm, the icemaker will stop producing ice.

It is normal for several cubes to be joined together.

If ice is not used frequently, old ice cubes will become cloudy, taste stale and shrink.

**NOTE:** In homes with lower-than-average water pressure, you may hear the icemaker cycle multiple times when making one batch of ice.

### Icemaker Accessory Kit

If your refrigerator did not come already equipped with an automatic icemaker, an icemaker accessory kit is available at extra cost.

Check the back of the refrigerator for the specific icemaker kit needed for your model.



## Cleaning the Outside

**The door handles and trim.** Clean with a cloth dampened with soapywater. Dry with a soft cloth. Do not use wax on the door handles and trim.

**Keep the outside clean.** Wipe with a cleancloth lightly dampened with kitchen appliance wax or mildliquid dish detergent. Dry and polishwith a clean,soft cloth.

Do not wipe the refrigerator with a soiled dish cloth or wet towel. These may leave a residue that can erode the paint.

Do not use scouring pads, powdered cleaners, bleach or cleaners containing bleach because these products can scratch and weaken the paint finish.

**The stainless steel panels and door handles.** Stainless steel (on some models) can be cleaned with a commercially available stainless steel cleaner. A spray-on stainless steel cleaner works best.

Do not use appliance wax or polish on the stainless steel.

## Cleaning the Inside

**To help prevent odors,** leave an open box of baking soda in the refrigerator and freezer compartments.

**Unplug the refrigerator before cleaning.** If this is not practical, wring excess moisture out of sponge or cloth when cleaning around switches, lights or controls.

Use warm water and baking soda solution - about a tablespoon (15 g) of baking soda to a quart (1 liter) of water. This both cleans and neutralizes odors. Thoroughly rinse and wipe dry.

After cleaning the door gaskets, apply a thin layer of petroleum jelly to the door gaskets at the hinge side. This helps keep the gaskets from sticking and bending out of shape.

Avoid cleaning cold glass shelves with hot water because the extreme temperature difference may cause them to break. Handle glass shelves carefully. Bumping tempered glass can cause it to shatter.

Do not wash any plastic refrigerator parts in the dishwasher.

## Behind the Refrigerator

Be careful when moving the refrigerator away from the wall. All types of floor coverings can be damaged, particularly cushioned coverings and those with embossed surfaces.

Pull the refrigerator straight out and return it to position by pushing it straight in.

Moving the refrigerator in a side direction may result in damage to the floor covering or refrigerator.

*When pushing the refrigerator back, make sure you don't roll over the power cord or icemaker supply line (on some models).*

## Preparing for Vacation

For long vacations or absences, remove food and unplug the refrigerator. Clean the interior with a baking soda solution of one tablespoon (15 g) of baking soda to one quart (1 liter) of water. Leave the doors open.

Set the icemaker power switch to the **O (off)** position and shut off the water supply to the refrigerator.

If the room temperature can drop below freezing, have a qualified servicer drain the water supply system (on some models) to prevent serious property damage due to flooding.

## Preparing to Move

Secure all loose items such as shelves and drawers by taping them securely in place to prevent damage.

When using a hand truck to move the refrigerator, do not rest the front or back of the refrigerator against the hand truck.

This could damage the refrigerator. Handle only from the sides of the refrigerator.

*Be sure the refrigerator stays in an upright position during moving.*

## Replacing the light bulbs.

Turning the control to the **0 (off)** position does not remove power to the light circuit.

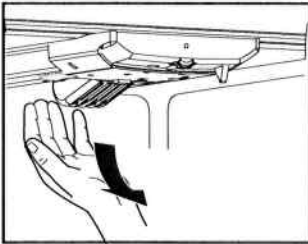

### Refrigerator Light

**⚠ CAUTION:** Light bulbs may be hot.

- 1 Unplug the refrigerator.
- 2 To remove the light shield, grasp the shield at the back and pull out to release the tabs at the back.
- 3 Rotate the shield down and then forward to release the tabs at the front of the shield.

- 4 After replacing with an appliance bulb of the same or lower wattage, replace the shield.
- 5 Plug the refrigerator back in.

**NOTE:** Appliance bulbs may be ordered from GE Parts and Accessories, 1.800.661.1616.

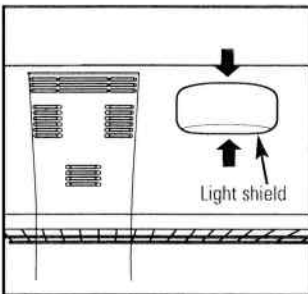

### Freezer Light (on some models)

**⚠ CAUTION:** Light bulbs may be hot.

- 1 Unplug the refrigerator.
- 2 The bulb is located behind a light shield at the back of the freezer compartment. To remove, squeeze the top and bottom of the shield and pull the shield off.

- 3 After replacing with an appliance bulb of the same or lower wattage, replace the shield.
- 4 Plug the refrigerator back in.

# Installation Instructions

# Refrigerator

*Model 20*

**Questions? Call 1.800.561.3344** or Visit our Website at: **[www.geappliances.ca](http://www.geappliances.ca)**

## BEFORE YOU BEGIN

Read these instructions completely and carefully.

- **IMPORTANT** -Save these instructions for local inspector's use.
- **IMPORTANT** -Observe all governing codes and ordinances.
- **Note to Installer** -Be sure to leave these instructions with the Consumer.
- **Note to Consumer** - Keep these instructions for future reference.
- **Skill level** -Installation of this appliance requires basic mechanical skills.
- **Completion time** -Refrigerator Installation 20 min  
-Water Line Installation 30 min  
(on some models)
- Proper installation is the responsibility of the installer.
- Product failure due to improper installation is not covered under the Warranty.

## WATER SUPPLY TO THE ICEMAKER (On some models)

If the refrigerator has an icemaker, it will have to be connected to a cold water line. A GE water supply kit (containing tubing, shutoff valve, fittings and instructions) is available at extra cost from your dealer, by visiting our Website at [geappliances.ca](http://geappliances.ca) or from Parts and Accessories, 1.800.661.1616.

## REFRIGERATOR LOCATION

- Do not install the refrigerator where the temperature will go below 60F (16C) because it will not run often enough to maintain proper temperatures.
- Do not install the refrigerator where the temperature will go above 100F (37C) because it will not perform properly.
- Install it on a floor strong enough to support it fully loaded.

## CLEARANCES

Allow the following clearances for ease of installation, proper air circulation and plumbing and electrical connections:

- Sides 18" (3 mm)
- Top 1" (24 mm)
- Back 1" (25 mm)

## ROLLERS

The rollers have 3 purposes:

- Rollers adjust so the doors close on their own when opened about 45°.
- Rollers adjust so the refrigerator is firmly positioned on the floor and does not wobble.
- Rollers allow you to move the refrigerator away from the wall for cleaning.

To adjust the rollers:

- ⑦ Using a screwdriver, turn the two front roller adjusting screws **clockwise** to raise the refrigerator, counterclockwise to lower it.

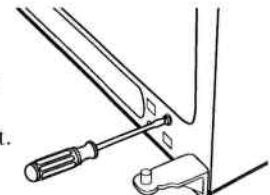

## REMOVE PACKAGING

Remove all tape, foam and protective packing from shelves and drawers.

# Installation Instructions

## INSTALLING THE WATER LINE (ON SOME MODELS)

### BEFORE YOU BEGIN

Recommended copper water supply kits are WX8X2, WX8X3 or WX8X4, depending on the amount of tubing you need. Approved plastic water supply lines are **GE SmartConnect™ Refrigerator Tubing** (WX08X10006, WX08X10015 and WX08X10025).

When connecting your refrigerator to a GE Reverse Osmosis Water System, the only approved installation is with a GE RVKit. For other reverse osmosis water systems, follow the manufacturer's recommendations.

This water line installation is not warranted by the refrigerator or icemaker manufacturer. Follow these instructions carefully to minimize the risk of expensive water damage.

Water hammer (water banging in the pipes) in house plumbing can cause damage to refrigerator parts and lead to water leakage or flooding. Call a qualified plumber to correct water hammer before installing the water supply line to the refrigerator.

To prevent burns and product damage, do not hook up the water line to the hot water line.

If you use your refrigerator before connecting the water line, make sure the icemaker power switch is in the **O (off)** position.

Do not install the icemaker tubing in areas where temperatures fall below freezing.

When using any electrical device (such as a power drill) during installation, be sure the device is double insulated or grounded in a manner to prevent the hazard of electric shock, or is battery powered.

All installations must be in accordance with local plumbing code requirements.

### WHAT YOU WILL NEED



- **Copper or GE SmartConnect Refrigerator Tubing kit, 1/4" outer diameter** to connect the refrigerator to the water supply. If using copper, be sure both ends of the tubing are cut square.

To determine how much tubing you need: measure the distance from the water valve on the back of the refrigerator to the water supply pipe. Then add 8' (2.4 m). Be sure there is sufficient extra tubing (about 8' [2.4 m] coiled into 3 turns of about 10" [25 cm] diameter) to allow the refrigerator to move out from the wall after installation.

**GE SmartConnect™ Refrigerator Tubing Kits** are available in the following lengths:

- 6' (1.8 m) – WX08X10006
- 15' (4.6 m) – WX08X10015
- 25' (7.6 m) – WX08X10025

Be sure that the kit you select allows at least 8' (2.4m) as described above.

**NOTE: The only GE approved plastic tubing is that supplied in GE SmartConnect™ Refrigerator Tubing kits. Do not use any other plastic water supply line because the line is under pressure at all times. Certain types of plastic will crack or rupture with age and cause water damage to your home.**

# Installation Instructions

## WHAT YOU WILL NEED (CONT.)

- A **GE water supply kit** (containing tubing, shutoff valve and fittings listed below) is available at extra cost from your dealer or from Parts and Accessories, 1.800.661.1616.
- A **cold water supply**. The water pressure must be between 20 and 120 p.s.i. (1.4 – 8.1 bar).

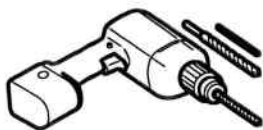

- **Power drill**.
- **1/2" or adjustable wrench**.
- **Straight and Phillips blade screwdriver**.

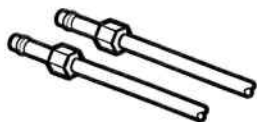

- **Two 1/4" outer diameter compression nuts and 2 ferrules (sleeves)** - to connect the copper tubing to the shutoff valve and the refrigerator water valve.

**OR**

- If you are using a GE SmartConnect™ Refrigerator Tubing kit, the necessary fittings are preassembled to the tubing.

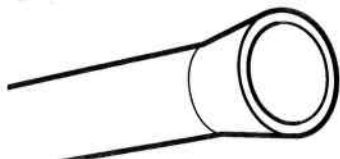

- If your existing copper water line has a flared fitting at the end, you will need an **adapter** (available at plumbing supply stores) to connect the water line to the refrigerator **OR** you can cut off the flared fitting with a **tube cutter** and then use a compression fitting. Do not cut formed end from GE SmartConnect™ Refrigerator tubing.



- **Shutoff valve** to connect to the cold water line. The shutoff valve should have a water inlet with a minimum inside diameter of 5/32" at the point of connection to the **COLD WATER LINE**. Saddle-type shutoff valves are included in many water supply kits. Before purchasing, make sure a saddle-type valve complies with your local plumbing codes.

Install the shutoff valve on the nearest frequently used drinking water line.

## 1 SHUT OFF THE MAIN WATER SUPPLY

Turn on the nearest faucet long enough to clear the line of water.

## 2 CHOOSE THE VALVE LOCATION

Choose a location for the valve that is easily accessible. It is best to connect into the side of a vertical water pipe. When it is necessary to connect into a horizontal water pipe, make the connection to the top or side, rather than at the bottom, to avoid drawing off any sediment from the water pipe.

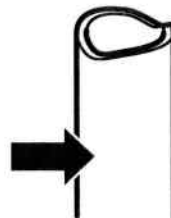

## 3 DRILL THE HOLE FOR THE VALVE

Drill a 1/4" hole in the water pipe (even if using a self-piercing valve) using a sharp bit. Remove any burrs resulting from drilling the hole in the pipe. **Take care not to allow water to drain into the drill.** Failure to drill a 1/4" hole may result in reduced ice production or smaller cubes.

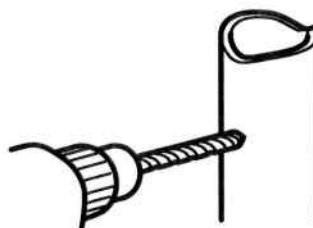

# Installation Instructions

## INSTALLING THE WATER LINE (CONT.)

### 4 FASTEN THE SHUTOFF VALVE

Fasten the shutoff valve to the cold water pipe with the pipe clamp.

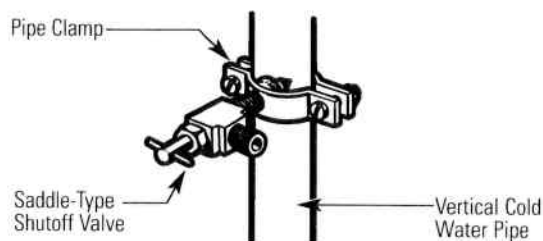

### 5 TIGHTEN THE PIPE CLAMP

Tighten the clamp screws until the sealing washer begins to swell.

NOTE: Do not overtighten or you may crush the tubing.

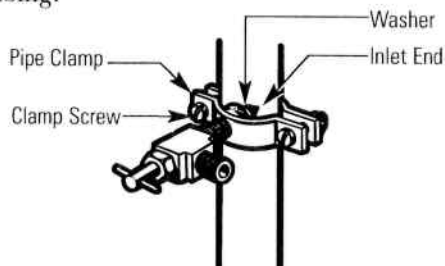

### 6 ROUTE THE TUBING

Route the tubing between the cold water line and the refrigerator.

Route the tubing through a hole drilled in the wall or floor (behind the refrigerator or adjacent base cabinet) as close to the wall as possible.

NOTE: Be sure there is sufficient extra tubing (about 8 feet [244 cm] coiled into 3 turns of about 10" [25 cm] diameter) to allow the refrigerator to move out from the wall after installation.

### 7 CONNECT THE TUBING TO THE VALVE

Place the compression nut and ferrule (sleeve) for copper tubing onto the end of the tubing and connect it to the shutoff valve.

Make sure the tubing is fully inserted into the valve. Tighten the compression nut securely.

For plastic tubing from a GE SmartConnect™ Refrigerator Tubing kit, insert the molded end of the tubing into the shutoff valve and tighten compression nut until it is hand tight, then tighten one additional turn with a wrench. Overtightening may cause leaks.

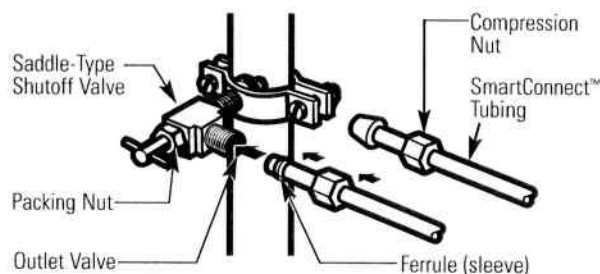

### 8 FLUSH OUT THE TUBING

Turn the main water supply on and flush out the tubing until the water is clear.

Shut the water off at the water valve after about one quart (1 liter) of water has been flushed through the tubing.



# Installation Instructions

## 9 CONNECT THE TUBING TO THE REFRIGERATOR

### NOTES:

- Before making the connection to the refrigerator, be sure the refrigerator power cord is not plugged into the wall outlet.
- We recommend installing a water filter if your water supply has sand or particles that could clog the screen of the refrigerator's water valve. Install it in the water line near the refrigerator. If using GE SmartConnect™ Refrigerator Tubing kit, you will need an additional tube (WX08X10002) to connect the filter. Do not cut plastic tube to install filter.

Remove the access cover.

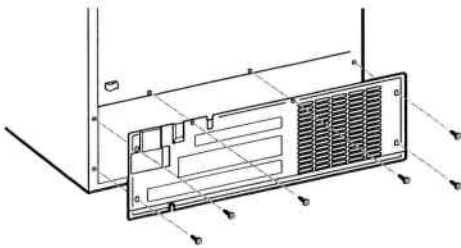

Remove the plastic flexible cap from the water valve (refrigerator connection).

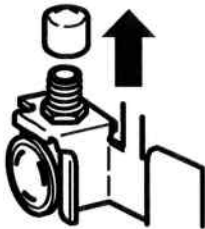

Place the compression nut and ferrule (sleeve) onto the end of the tubing as shown. On GE SmartConnect™ Refrigerator Tubing kit, the nuts are already assembled to the tubing.

Insert the end of the tubing into the water valve connection as far as possible. While holding the tubing, tighten the fitting.

For plastic tubing from a GE SmartConnect™ Refrigerator Tubing kit, insert the molded end of the tubing into the shutoff valve and tighten compression nut until it is hand tight, then tighten one additional turn with a wrench. Overtightening may cause leaks.

## 9 CONNECT THE TUBING TO THE REFRIGERATOR (CONT.)

Fasten the tubing into the clamp provided to hold it in a vertical position. You may need to pry open the clamp.

One of the illustrations below will look like the connection on your refrigerator.

### Icemaker Models without Water Dispenser

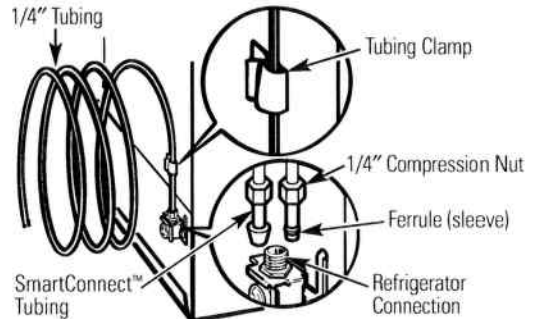

### Water Dispenser Models

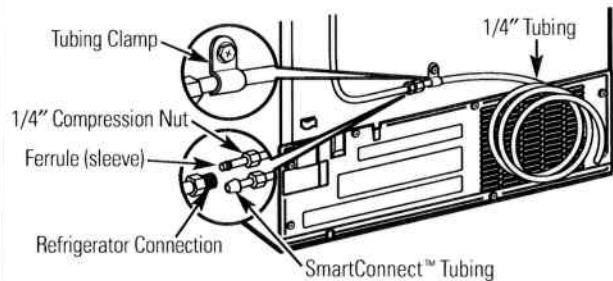

## 10 TURN THE WATER ON AT THE SHUTOFF VALVE

Tighten any connections that leak.

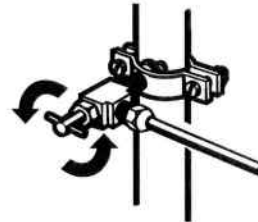

Reattach the access cover.

# Installation Instructions

## INSTALLING THE WATER LINE (CONT.)

### 11 PLUG IN THE REFRIGERATOR

Arrange the coil of tubing so that it does not vibrate against the back of the refrigerator or against the wall. Push the refrigerator back to the wall.

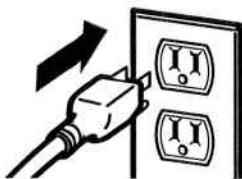

### 12 START THE ICEMAKER

**Power switch models** – Set the icemaker power switch to the **I (on)** position. The icemaker will not begin to operate until it reaches its operating temperature of 15°F (-9°C) or below. It will then begin operation automatically if the icemaker power switch is in the **I (on)** position, and the green light will come on.

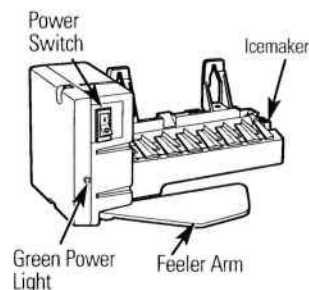

Power switch model

## REVERSING THE DOOR SWING

### IMPORTANT NOTES

When reversing the door swing:

- Read the instructions all the way through before starting.
- Handle parts carefully to avoid scratching paint.
- Set screws down by their related parts to avoid using them in the wrong places.
- Provide a non-scratching work surface for the doors.

**IMPORTANT:** Once you begin, do not move the cabinet until door-swing reversal is completed.

These instructions are for changing the hinges from the right side to the left side—if you ever want to change the hinges back to the right side, follow these same instructions and reverse all references to left and right.

- Once door swing is finalized, ensure the logo badge is properly aligned and permanently secured to the door by removing the adhesive cover on the back side.

**NOTE:** A replacement logo badge is included.

**Unplug the refrigerator from its electrical outlet. Empty all door shelves, including the dairy compartment.**

### TOOLS YOU WILL NEED



Adjustable Wrench

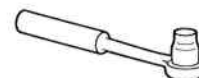

5/16" Socket Ratchet Driver



Masking Tape

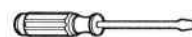

Thin-blade Screwdriver

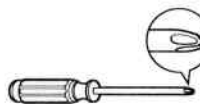

Phillips Screwdriver



Torx T-20 Driver



# Installation Instructions

## 1 REMOVE THE FREEZER DOOR

- A** Tape the door shut with masking tape.

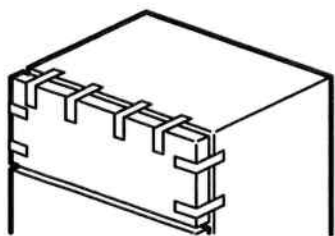

- B** Remove the hinge cover on top of the freezer door (on some models).
- C** Using a 5/16" socket ratchet/driver, remove the two screws, then lift the hinge straight up to free the hinge pin from the socket in the top of the door.

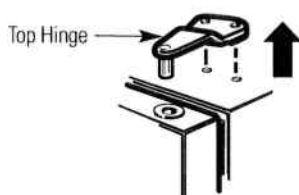

- D** Remove the tape and tilt the door away from the cabinet. Lift it off the center hinge pin.
- E** Set the door on a non-scratching surface with the inside up.

## 2 REMOVE THE REFRIGERATOR DOOR

- A** Tape the door shut with masking tape.
- B** Using an adjustable wrench remove the center hinge pin from the hinge bracket.

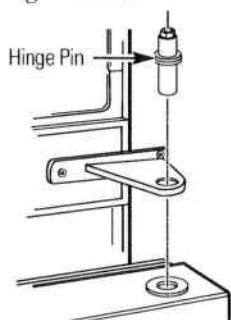

- C** Remove the tape and tilt the door away from the cabinet. Lift the door straight off the bottom hinge bracket.
- D** Set the door on a non-scratching surface, with the inside up.

**CAUTION:** Do not let door drop to the floor. To do so could damage the door stop.

## 3 TRANSFER TOP HINGE TO THE LEFT

- A** Remove the plug covers at top left side using the edge of a thin flat blade to gently pry the plug off. Cover the blade with tape to prevent scratching the paint. You will assemble the plug covers in to the right side.

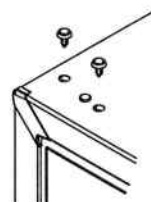

- B** Transfer hinge and screw on top right to the top left of cabinet.

**Do not tighten screws on hinge side at this time.**

## 4 TRANSFER BOTTOM HINGE BRACKET TO THE LEFT

- A** Using a 5/16" socket ratchet/driver, move the bottom hinge bracket from the right side to the left side.
- B** Move the hinge pin to the other hinge bracket hole and the lower screw to the side hole.

**NOTE:** Make sure the spacer is between the cabinet and the bracket hinge.

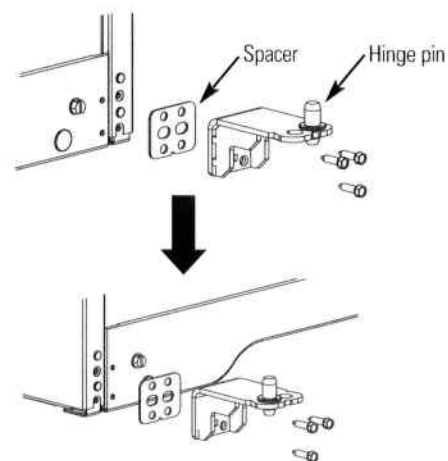

# Installation Instructions

## REVERSING THE DOOR SWING (CONT.)

### 5 TRANSFER CENTER HINGE BRACKET TO THE LEFT

Using a torx T-20 driver remove the center hinge bracket by removing the three screws.

**NOTE:** Keep these screws with the hinge bracket. They are long screws and will be used when installing the hinge on the other side.

You will need to remove the color-matched cap from the screw head before you can remove the screw. Use the edge of a thin flat blade to gently pry the caps off the screw heads. (A putty knife works well for this.) Cover the blade with tape to prevent scratching the paint.

Remove the mullion cover from the left side using the thin flat blade. Assemble it to the right side.

Remove the screw from the center left side of the cabinet. Screw it into the holes on the right side.

Replace the cap by snapping it over the screw with your finger.

Place the center hinge bracket over the holes at the center left side of the cabinet. Insert and tighten the three long screws.

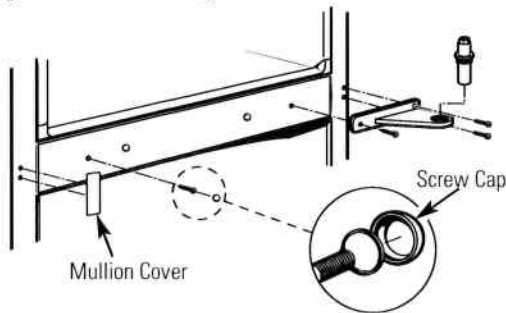

### 6 TRANSFER DOOR STOPS

On each door, remove the door stop on the right side of the bottom of the door by removing the two screws. Install the door stop on the left side.

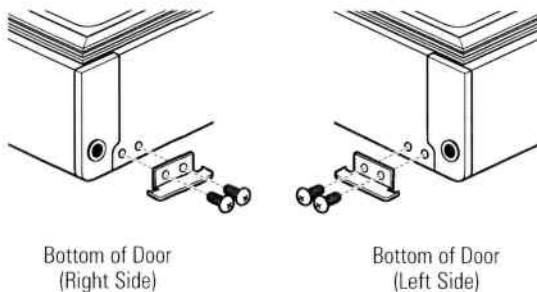

### 7 TRANSFER FRESHFOOD DOOR HANDLE TO THE RIGHT

**Stainless steel handle:**

**A** Remove the two screws holding the handle to the bottom of the door. Loosen the set screw with the 3/32" Allen wrench (supplied) and remove the handle.

**B** Remove the handle fastener with the 3/16" Allen wrench.

**C** Transfer the fastener to the right side and move the GE badge to the left side of the door.

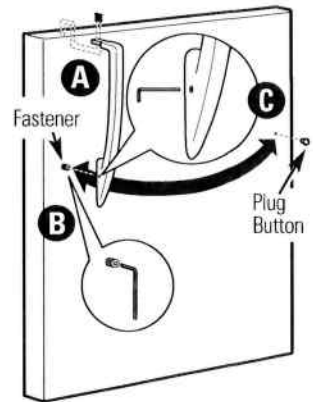

**Plastic handle:**

**A** Remove the two screws holding the handle to the top of the door.

**B** Remove the handle plug by carefully prying under the edge with a putty knife. Remove the exposed screw holding the handle.

**C** Transfer the door plug button to the opposite side.

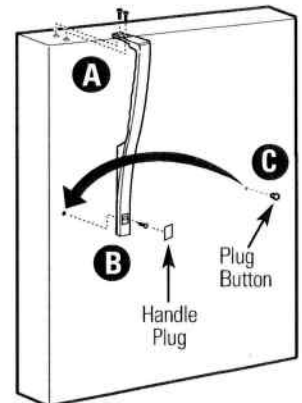

**After removing the handle:** Move the small plug buttons from the top right side of the door top and insert them into the holes on the opposite side.

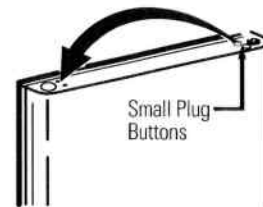

Move the large plug button from the left edge of the door and insert it into the hole on the opposite side.



# Installation Instructions

## 7 TRANSFER FRESH FOOD HANDLE TO THE RIGHT (CONT.)

### Stainless steel handle:

- A** Attach the handle to the fastener and tighten with the 3/32" Allen wrench (supplied).
- B** Line up the handle with the screw holes in the top of the door and tighten the screws.

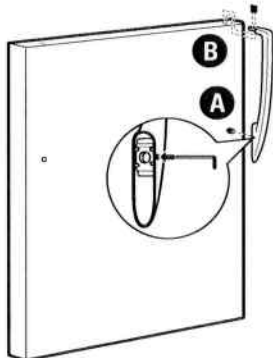

### Plastic handle:

- A** Line up the handle with the screw holes in the top and in the middle of the door and tighten the screws.
- B** Attach the handle plug

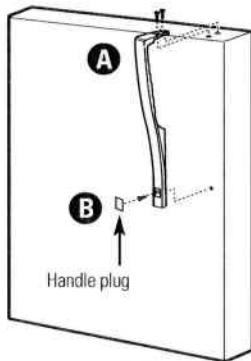

## 8 TRANSFER FREEZER DOOR HANDLE TO THE RIGHT

### Stainless steel handle:

- A** Remove the two screws holding the handle to the bottom of the door. Loosen the set screw with the 3/32" Allen wrench (supplied) and remove the handle.
- B** Remove the handle fastener with the 3/16" Allen wrench.
- C** Transfer the fastener to the right side and move the GE badge to the left side of the freezer door. Remove the paper covering on the adhesive backing prior to attaching the badge to the door.

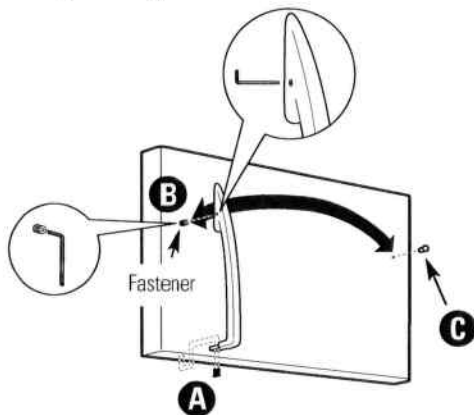

## 8 TRANSFER FREEZER DOOR HANDLE TO THE RIGHT (CONT.)

### Plastic handle:

- A** Remove the two screws holding the handle to the bottom of the door.
- B** Remove the handle plug by carefully prying under the edge with a putty knife. Remove the exposed screw holding the handle.
- C** Transfer the logo badge to the opposite side. Use the new badge (supplied), remove the paper covering on the adhesive backing prior to attaching to the door.

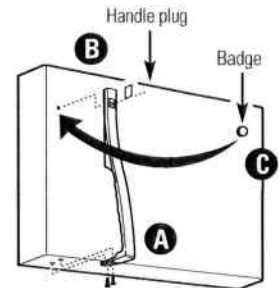

### Reinstalling the handle:

Attach the handle to the right side of the door.

### Stainless steel handle:

- A** Attach the handle to the fastener and tighten with the 3/32" Allen wrench (supplied).
- B** Line up the handle with the screw holes in the bottom of the door and tighten the screws.

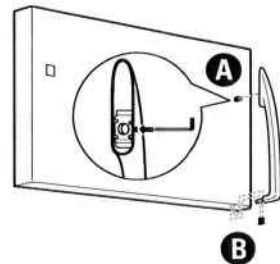

### Plastic handle:

- A** Line up the handle with the screw holes in the bottom and in the top of the door and tighten the screws.
- B** Attach the handle plug

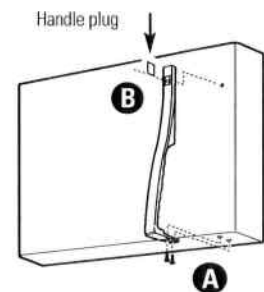

# Installation Instructions

## REVERSING THE DOOR SWING (CONT.)

### 9 REHANG THE REFRIGERATOR DOOR

Lower the refrigerator door onto the bottom hinge pin.

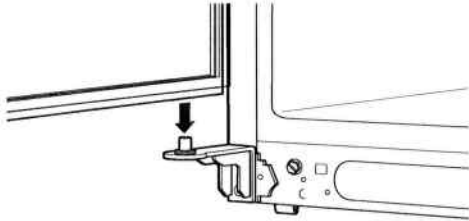

Straighten the door and line it up with the center hinge bracket.

Reinstall the center hinge pin with a 3/4" socket. Turn it until it extends through the hinge bracket and into the door.

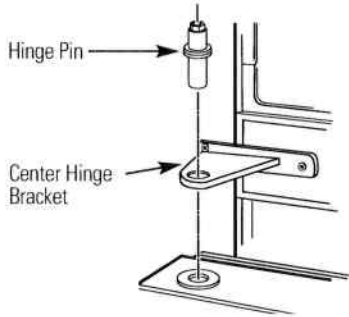

### 10 REHANG THE FREEZER DOOR

Lower the freezer door onto the center hinge pin.



Lift the top hinge so the pin fits into the door socket. Support the door on the handle side and make sure the door is straight and the gap between the doors is even across the front. While holding the door in place, tighten the top hinge screws.

## Normal operating sounds.



Newer refrigerators sound different from older refrigerators. Modern refrigerators have more features and use newer technology.

**Do you hear what I hear? These sounds are normal.**

**HUMMM...  
WHOOSH...**

- The new high efficiency compressor may run faster and longer than your old refrigerator and you may hear a high-pitched hum or pulsating sound while it is operating.
- You may hear a whooshing sound when the doors close. This is due to pressure equalizing within the refrigerator.  
**Electronic models only:**
- Sometimes the refrigerator runs for an extended period, especially when the doors are opened frequently. This means that the **Frost Guard™** feature is working to prevent freezer burn and improve food preservation.

**WHIR!**



- You may hear the fans spinning. The fans help to maintain the correct temperatures.  
**Electronic models only:**
- You may hear the fans spinning at high speeds. This happens when the refrigerator is first plugged in, when the doors are opened frequently or when a large amount of food is added to the refrigerator or freezer compartments.
- If either door is open for over 3 minutes, you may hear the fans come on in order to cool the light bulbs.
- The fans change speeds in order to provide optimal cooling and energy savings.

## CLICKS, POPS, CRACKS and CHIRPS

- You may hear cracking or popping sounds when the refrigerator is first plugged in. This happens as the refrigerator cools to the correct temperature.
- The compressor may cause a clicking or chirping sound when attempting to restart (this could take up to 5 minutes).
- The electronic control board may cause a clicking sound when relays activate to control refrigerator components.
- Expansion and contraction of cooling coils during and after defrost can cause a cracking or popping sound.
- On models with an icemaker, after an icemaking cycle, you may hear the ice cubes dropping into the ice bucket.
- On models with a dispenser, during water dispense, you may hear the water lines move at initial dispense and after dispenser button is released.

## WATER SOUNDS



- The flow of refrigerant through the freezer cooling coils may make a gurgling noise like boiling water.
- Water dropping on the defrost heater can cause a sizzling, popping or buzzing sound during the defrost cycle.
- A water dripping noise may occur during the defrost cycle as ice melts from the evaporator and flows into the drain pan.
- Closing the door may cause a gurgling sound due to pressure equalization.



For additional information on normal icemaker operating sounds, see the **About the automatic icemaker section.**

## Before you call for service...



**Troubleshooting Tips**  
Save time and money! Review the charts on the following pages first and you may not need to call for service.

<b>Problem</b>	<b>Possible Causes</b>	<b>What To Do</b>
<b>Refrigerator does not operate</b>	Refrigerator in defrost cycle.	• Wait about 40 minutes for defrost cycle to end.
	The controls are set to the <b>O (off)</b> position.	• Move the refrigerator and freezer control to a temperature setting.
	Refrigerator is unplugged.	• Push the plug completely into the outlet.
	The fuse is blown/circuit breaker is tripped.	• Replace fuse or reset the breaker.
<b>Vibration or rattling (slight vibration is normal)</b>	Rollers need adjusting.	• See <i>Rollers</i> .
<b>Motor operates for long periods or cycles on and off frequently. (Modern refrigerators with more storage space and a larger freezer require more operating time. They start and stop often to maintain even temperatures.)</b>	Normal when refrigerator is first plugged in.	• Wait 12–24 hours for the refrigerator to completely cool down.
	Often occurs when large amounts of food are placed in refrigerator.	• This is normal.
	Door left open.	• Check to see if package is holding door open.
	Hot weather or frequent door openings.	• This is normal.
	Temperature controls set at the coldest setting.	• See <i>About the controls</i> .
<b>Refrigerator or freezer compartment too warm</b>	Temperature control not set cold enough.	• See <i>About the controls</i> .
	Warm weather or frequent door openings.	• Set the temperature control one step colder. See <i>About the controls</i> .
	Door left open.	• Check to see if package is holding door open.
<b>Frost or ice crystals on frozen food (frost within package is normal)</b>	Door left open.	• Check to see if package is holding door open.
	Too frequent or too long door openings.	
<b>Automatic icemaker (on some models) does not work</b>	Icemaker power switch is in the <b>O (off)</b> position.	• Set the power switch to the <b>I (on)</b> position.
	Water supply turned off or not connected.	• See <i>Installing the water line</i> .
	Freezer compartment too warm.	• Wait 12–24 hours for the refrigerator to completely cool down.
	Piled up cubes in the storage bin cause the icemaker to shut off.	• Level cubes by hand.
<b>Frequent “buzzing” sound</b>	Ice cubes stuck in icemaker. (Green power light on icemaker blinking.)	• Turn off the icemaker, remove cubes and turn the icemaker back on.
	Icemaker power switch is in the <b>I (on)</b> position, but the water supply to the refrigerator has not been connected.	• Set the power switch to the <b>O (off)</b> position. Keeping it in the <b>I (on)</b> position will damage the water valve.

# Before you call for service...

geappliances.ca



## Troubleshooting Tips

<b>Problem</b>	<b>Possible Causes</b>	<b>What To Do</b>
<b>Ice cubes have odor/taste</b>	Ice storage bin needs cleaning.	• Empty and wash bin. Discard old cubes.
	Food transmitting odor/taste to ice cubes.	• Wrap foods well.
<b>Slow ice cube freezing</b>	Interior of refrigerator needs cleaning.	• See <i>Care and cleaning</i> .
	Door left open.	• Check to see if package is holding door open.
<b>No ice cube production</b>	Temperature control not set cold enough.	• See <i>About the controls</i> .
	Supply line or shutoff valve is clogged.	• Call a plumber.
<b>Refrigerator has odor</b>	Foods transmitting odor to refrigerator.	• Foods with strong odors should be tightly wrapped. • Keep an open box of baking soda in the refrigerator; replace every three months.
	Interior needs cleaning.	• See <i>Care and cleaning</i> .
<b>Moisture collects inside (in humid weather, air carries moisture into refrigerator when doors are opened)</b>	Too frequent or too long door openings.	
<b>Interior light does not work</b>	No power at outlet.	• Replace fuse or reset the breaker.
	Light bulb burned out.	• See <i>Replacing the light bulbs</i> .
<b>Hot air from bottom of refrigerator</b>	Normal air flow cooling motor. In the refrigeration process, it is normal that heat be expelled in the area under the refrigerator. Some floor coverings are sensitive and will discolor at these normal and safe temperatures.	
<b>Food freezing in the refrigerator</b>	Food too close to air vent.	• Move the food away from the air vent (near the controls).
	Refrigerator control is set too cold.	• Move the refrigerator control to a warmer temperature.
<b>Door does not close by itself</b>	Rollers need adjusting.	• See <i>Rollers</i> .
<b>Orange glow in the freezer</b>	Defrost heater is on.	• This is normal.

Safety Instructions

Operating Instructions

Installation Instructions

Troubleshooting Tips

Consumer Support

## CUSTOMER WARRANTY

(for customers in Canada)

Your refrigerator is warranted to be free of defects in material and workmanship.

What is covered	How Long Warranted (From Date of Sale)	Parts Repair or Replace at Mabe's Option	Labour
Compressor	GE Profile: Ten (10) Years GE and All Other Brands: One (1) Year	GE Profile: Ten (10) Years GE and All Other Brands: One (1) Year	GE Profile: Five (5) Years GE and All Other Brands: One (1) Year
Sealed System (including evaporator, condenser tubing and refrigerant)	GE Profile: Five (5) Years GE and All Other Brands: One (1) Year	GE Profile: Five (5) Years GE and All Other Brands: One (1) Year	GE Profile: Five (5) Years GE and All Other Brands: One (1) Year
All Other Parts	One (1) Year	One (1) Year	One (1) Year

### TERMS AND CONDITIONS:

This warranty applies only for single family domestic use in Canada when the Refrigerator has been properly installed according to the instructions supplied by Mabe and is connected to an adequate and proper utility service.

Damage due to abuse, accident, commercial use, and alteration or defacing of the serial plate cancels all obligations of this warranty.

Service during this warranty period must be performed by an Authorized Mabe Service Agent.

Neither Mabe nor the Dealer is liable for any claims or damages resulting from failure of the Refrigerator or from service delays beyond their reasonable control.

To obtain warranty service, purchaser must present the original Bill of Sale. Components repaired or replaced are warranted through the remainder of the original warranty period only.

This warranty is extended to the original purchaser and any succeeding owner for products purchased for home use within Canada. In home warranty service will be provided in areas where it is available and deemed reasonable by Mabe to provide.

This warranty is in addition to any statutory warranty.

### WHAT IS NOT COVERED:

- Owner is responsible to pay for service calls related to product installation and/or teaching how to use the product.
- Damage to finish must be reported within 48 hours following the delivery of the appliance.
- Damage to finish after delivery.
- Improper installation—proper installation includes adequate air circulation to the refrigeration system, adequate electrical, plumbing and other connecting facilities.
- Replacement of house fuses or resetting of circuit breakers.
- Replacement of light bulbs.
- Damage to product caused by accident, fire, floods or acts of God.
- Loss of food due to spoilage.
- Proper use and care of product as listed in the owner's manual, proper setting of controls.
- Product not accessible to provide required service.
- **WARRANTOR IS NOT RESPONSIBLE FOR CONSEQUENTIAL DAMAGES.**

***EXCLUSION OF IMPLIED WARRANTIES—Your sole and exclusive remedy is product repair as provided in this Limited Warranty. Any implied warranties, including the implied warranties of merchantability or fitness for a particular purpose, are limited to one year or the shortest period allowed by law.***

### IMPORTANT

**Keep this warranty and your bill of sale as proof of original purchase and purchase date.  
Please have serial number and model number available when calling for service.**

Mabe Service is available coast to coast. If further help is needed concerning this warranty, contact:

Manager, Consumer Relations  
Mabe Canada Inc., Consumer Service  
1 Factory Lane, Suite 310  
Moncton, New Brunswick E1C 9M3  
1.800.561.3344

*Staple your receipt here.  
Proof of the original purchase  
date is needed to obtain service  
under the warranty.*



---

Please place in envelope and mail to:  
Veuillez mettre dans une enveloppe et envoyez à :

**OWNERSHIP REGISTRATION  
P.O. BOX 1780  
MISSISSAUGA, ONTARIO  
L4Y 4G1**

**(FOR CANADIAN CONSUMERS ONLY)**

---



For Canadian  
Customers



Pour les  
Consommateurs  
Canadiens

CUT ALONG THIS LINE AND RETURN CARD—THANKS

**OWNERSHIP REGISTRATION CERTIFICATE – FICHE D'INSCRIPTION DU PROPRIÉTAIRE**

Please register your product to enable us to contact you in the remote event a safety notice is issued for this product and to allow for efficient communication under the terms of your warranty, should the need arise.

Veillez enregistrer votre produit afin de nous permettre de communiquer avec vous si jamais un avis de sécurité concernant ce produit était émis et de communiquer facilement avec vous en vertu de votre garantie, si le besoin s'en fait sentir.

REGISTER ON-LINE: <a href="http://www.geappliances.ca">www.geappliances.ca</a>		MAIL TO: <b>P.O. BOX 1780, MISSISSAUGA ONTARIO, L4Y 4G1</b>	
ENREGISTREMENT SUR INTERNET À: <a href="http://www.electromenagersge.ca">www.electromenagersge.ca</a>		POSTER À:	
<input type="checkbox"/> MR./M	<input type="checkbox"/> MRS./MME.	FIRST NAME / PRÉNOM	LAST NAME / NOM
<input type="checkbox"/> MISS/Mlle.	<input type="checkbox"/> MS.		
STREET NO / N° RUE		STREET NAME / RUE	
		APT. NO / APP. / RR#	
CITY / VILLE		PROVINCE	POSTAL CODE / POSTAL
AREA CODE / IND. RÉG.	TELEPHONE	E-MAIL	
DID YOU PURCHASE A SERVICE CONTRACT FOR THIS APPLIANCE? AVEZ-VOUS ACHETÉ UN CONTRAT DE SERVICE POUR CET APPAREIL ?		YES / OUI <input type="checkbox"/>	IF YES / SI OUI: EXPIRATION
		NO / NON <input type="checkbox"/>	Y/A M D/J
NAME OF SELLING DEALER / NOM DU MARCHAND		MODEL / MODÈLE	
INSTALLATION DATE / DATE D'INSTALLATION Y/A M D/J	CORRESPONDENCE <input type="checkbox"/> ENGLISH CORRESPONDANCE <input type="checkbox"/> FRANÇAIS	SERIAL / SÉRIE	
<input type="checkbox"/> I do not wish to receive any promotional offers regarding this product. <input type="checkbox"/> Je ne désire pas recevoir d'offres promotionnelles concernant ce produit.			